

LANSCE

Los Alamos Neutron Science Center



neutron scattering

A PRIMER

by Roger Pynn



"Neutron man" personifies the neutron's dual nature, exhibiting wave and particle properties. Here he enters a crystal lattice as a plane wave (blue), interacts with the crystal lattice (green), and becomes, through interference effects, an outgoing plane wave (red) with a direction dictated by Bragg's law. His particle properties allow him to be absorbed by a helium atom in a neutron detector, and his time of flight is measured.

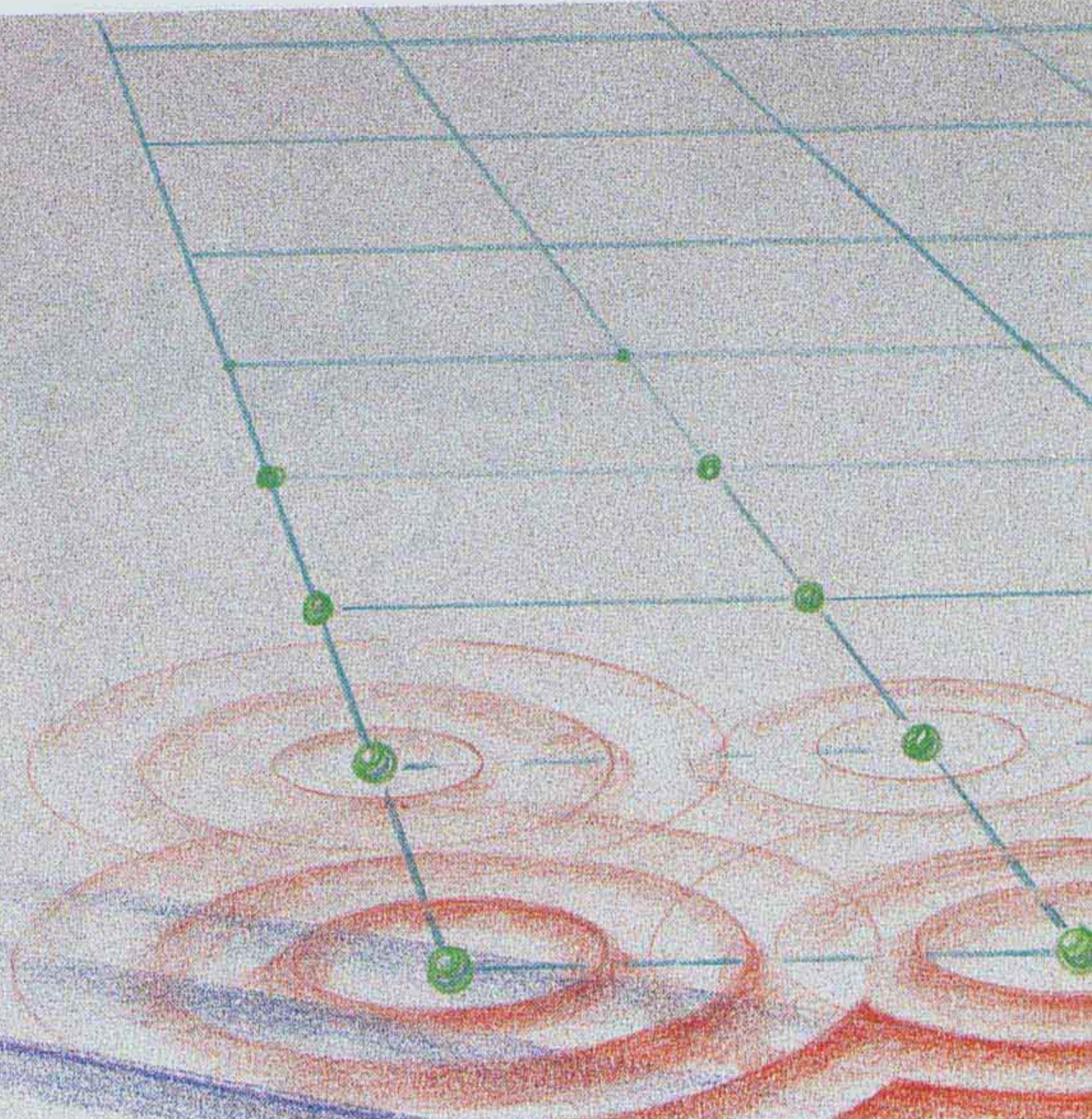
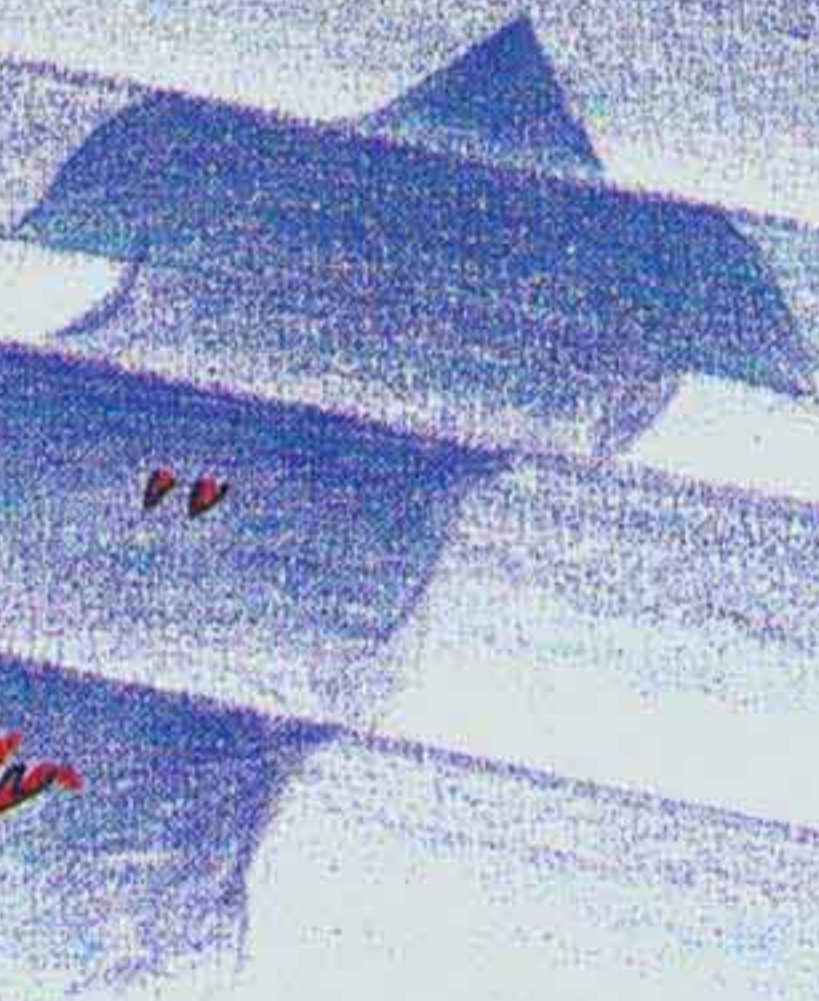

neutron scattering

A PRIMER

by Roger Pynn

How can we determine the relative positions and motions of atoms in a bulk sample of solid or liquid? Somehow we need to see inside the material with a suitable magnifying glass. But seeing with light in an everyday sense will not suffice. First, we can only see inside the few materials that are transparent, and second, there is no microscope that will allow us to see individual atoms. These are not merely technical hurdles, like those of sending a man to the moon, but intrinsic limitations. We cannot make an opaque body transparent nor can we see detail on a scale finer than the wavelength of the radiation we are using to observe it. For observations with visible light this limits

us to objects separated by about a micrometer (10^{-6} meter), which is more than a thousand times longer than the typical interatomic distance in a solid (about 10^{-10} meter or so).

X rays have wavelengths much shorter than those of visible light, so we might try using them to find atomic positions. For many crystalline materials this technique works quite well. The x rays are diffracted by the material, and one can work out the relative atomic positions from the pattern of spots the diffracted rays make on a photographic plate. However, not all atoms are equally "visible" to x rays:



the light atoms in the soft tissue of our jowls do not stop x rays as well as the heavy mercury atoms in the dental amalgam used to fill teeth. Although this phenomenon is useful to the dental profession, it is often an embarrassment for scientists measuring atomic positions.

X rays are scattered by the electrons surrounding the nucleus of an atom. As a result, heavy atoms with many electrons (such as mercury) scatter x rays more efficiently than light atoms (such as oxygen or, worse, hydrogen). Thus, x rays pass right through light materials without being greatly attenuated or deflected. It is for this reason that the structure of the much-heralded high-temperature superconductors was not determined by x-ray diffraction—in spite of the fact that most university physics departments worldwide have an x-ray machine. One of the first high-temperature superconductors discovered contained yttrium and copper, both of which are heavy and scatter a relatively large percentage of the x rays incident on a sample. Unfortunately, the superconductors also contained oxygen, whose feeble scattering of x rays is swamped by that of its heavy neighbors. It was impossible to determine the positions of the oxygen atoms using x-ray diffraction because the x rays passed through the superconductor almost without noticing the oxygen.

We might try to find atomic positions by “seeing” with electron beams. After all, quantum mechanics tells us that particles have wave properties, and the wavelength of electrons can easily be matched to interatomic distances by changing the electron energy. However, as anyone who has ever rubbed a balloon on the family cat knows, the interaction between electrical charges is strong. Not surprisingly then, a charged particle, such as an electron or a positron, does not travel far through solids or liquids before it is attracted or

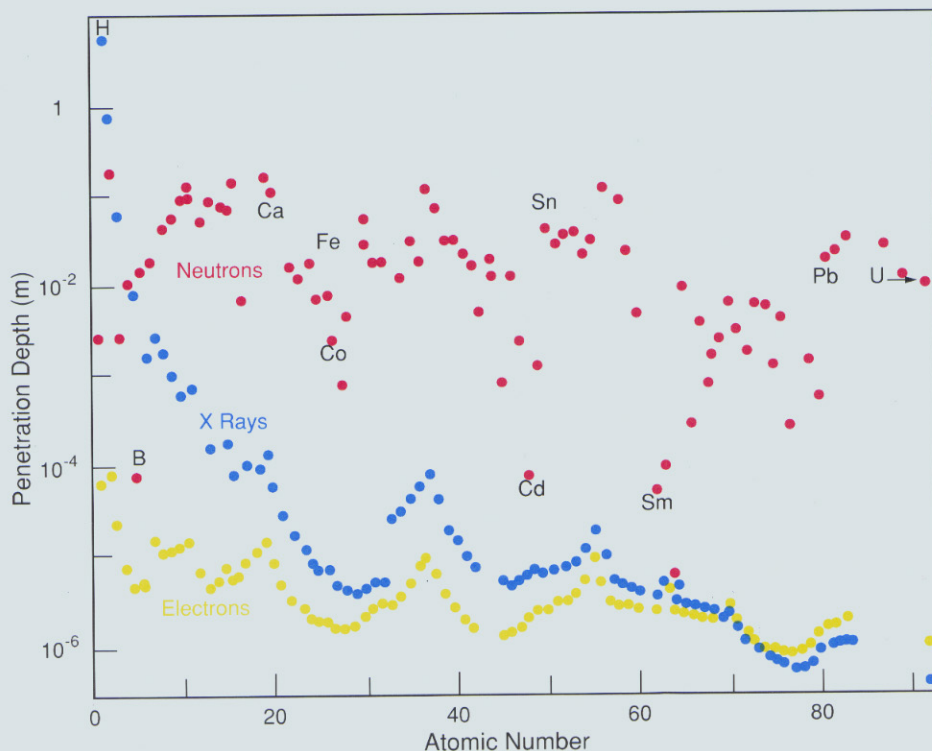

NEUTRON, ELECTRON, AND X-RAY PENETRATION DEPTHS

Fig. 1. The plot shows how deeply a beam of electrons, x rays, or thermal neutrons penetrates a particular element in its solid or liquid form before the beam's intensity has been reduced by a factor of $\frac{1}{e}$, that is, to about 37 percent of its original intensity. The neutron data are for neutrons having a wavelength of 1.4 angstroms (1.4×10^{-10} meter).

repelled by the electrons already in the matter. This makes electrons unsuitable for looking inside bulk materials: they suffer from the same opacity problem as light, and specially prepared, thin samples are required for electron microscopy.

Neutron Scattering

What about neutrons? They have no charge, and their electric dipole moment is either zero or too small to be measured by the most sensitive of modern techniques. For these reasons, neutrons can penetrate matter far better than charged particles. Furthermore, neutrons interact with atoms via *nuclear* rather

than electrical forces, and nuclear forces are very short range—of the order of a few fermis (1 fermi = 10^{-15} meter). Thus, as far as the neutron is concerned, solid matter is not very dense because the size of a scattering center (nucleus) is typically 100,000 times smaller than the distance *between* such centers. As a consequence, neutrons can travel large distances through most materials without being scattered or absorbed (see the opening illustration to “Putting Neutrons in Perspective”). The attenuation, or decrease in intensity, of a beam of low-energy neutrons by aluminum, for example, is about 1 percent per millimeter compared with 99 percent or more per millimeter for x rays. Figure 1 illus-

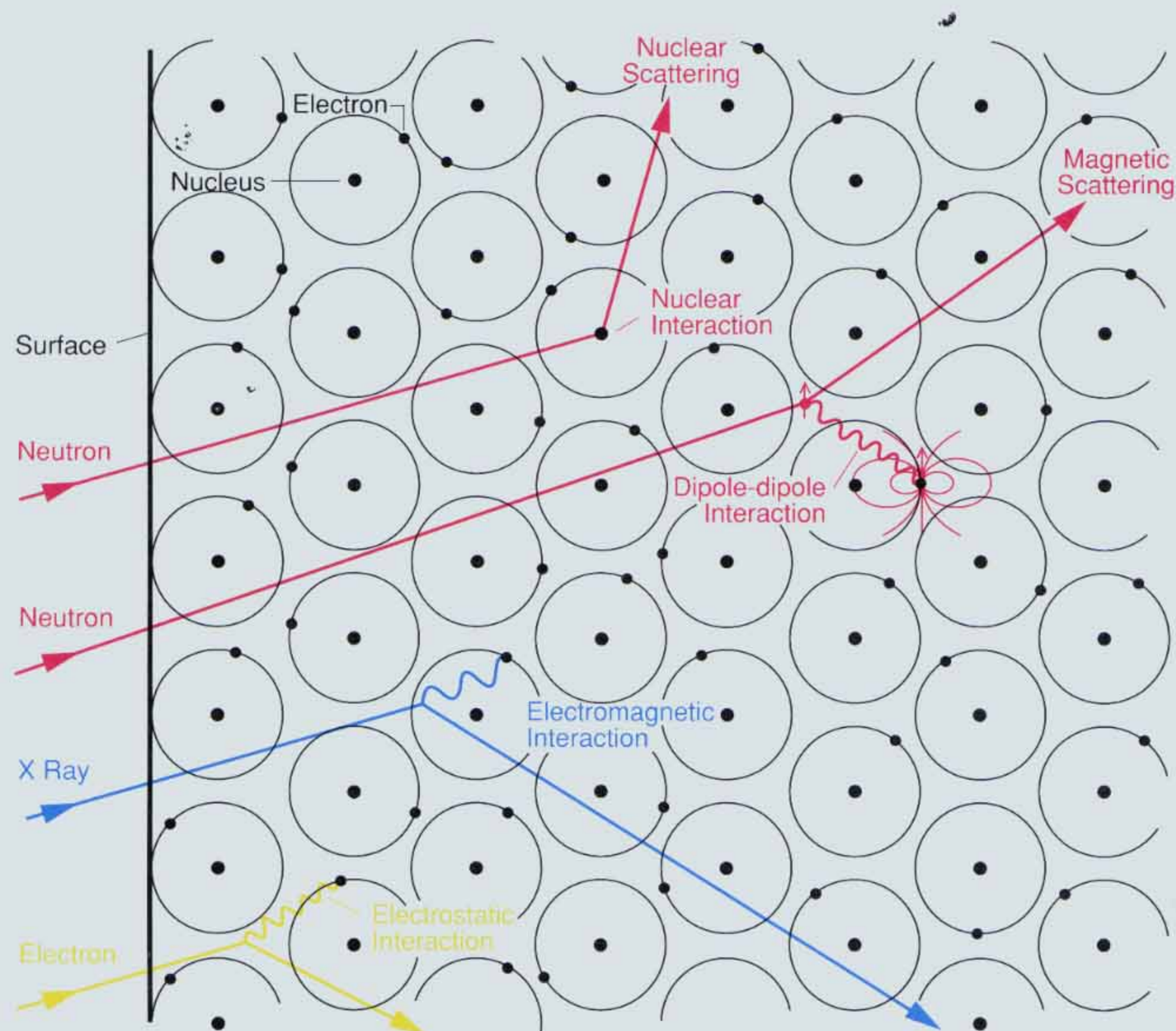

SCATTERING INTERACTIONS

Fig. 2. Beams of neutrons, x rays, and electrons interact with material by different mechanisms. X rays (blue) and electron beams (yellow) both interact with electrons in the material; with x rays the interaction is electromagnetic, whereas with an electron beam it is electrostatic. Both of these interactions are strong, and neither type of beam penetrates matter very deeply. Neutrons (red) interact with atomic nuclei via the very short-range strong nuclear force and thus penetrate matter much more deeply than x rays or electrons. If there are unpaired electrons in the material, neutrons may also interact by a second mechanism: a dipole-dipole interaction between the magnetic moment of the neutron and the magnetic moment of the unpaired electron.

trates this point for other atoms and for electrons as well as x rays and neutrons.

Like so many things in life, the neutron's penetrating power is a two-edged sword. On the plus side, the neutron can penetrate deep within a sample even if it first has to pass through a container (necessary, for example, if the sample is a fluid or has to be kept at low temperatures or high pressures). The corollary is that neutrons are only weakly

scattered once they do penetrate. Also, detection of a subatomic particle involves the observation of that particle's interaction with some other particle, so neutron detection requires a certain ingenuity (in practice, detectors make use of one of the few atoms, such as boron, helium-3, or lithium, that absorb neutrons strongly to produce ionizing radiation). To make matters worse, available neutron beams inherently have low in-

tensities. X-ray instruments at synchrotron-radiation facilities can provide fluxes of 10^{18} photons per second per square millimeter compared with 10^4 neutrons per second per square millimeter in the same energy bandwidth for powerful neutron-scattering instruments.

The combination of a weak interaction and low fluxes makes neutron scattering a *signal-limited technique*, which is practiced only because it provides information on the structure of materials that cannot be obtained by other means. This constraint means that no generic instrument can be designed to examine all aspects of neutron scattering. Instead, a veritable zoo of instruments has arisen with each species specializing in a particular aspect of the scattering phenomenon.

In spite of its unique advantages, neutron scattering is only one of a battery of techniques for probing the structures of materials. All of the techniques, such as x-ray scattering and electron microscopy, are needed if scientists are to understand the full range of structural properties of matter. In most cases, the different methods used to probe material structure give complementary information because the nature of the interaction between the radiation and the sample are different. For example, neutrons interact with nuclei, whereas x rays and electrons "see" only the electrons in matter (Fig. 2). To a certain extent the method of choice depends on the length scale of the structure to be investigated (Fig. 3). When two techniques address the same scale, additional information, such as the size and chemical composition of the sample, is required to choose the optimal technique.

Scattering by a Single Fixed Nucleus

The scattering of neutrons by nuclei is a quantum-mechanical process. Formally, the process has to be described in

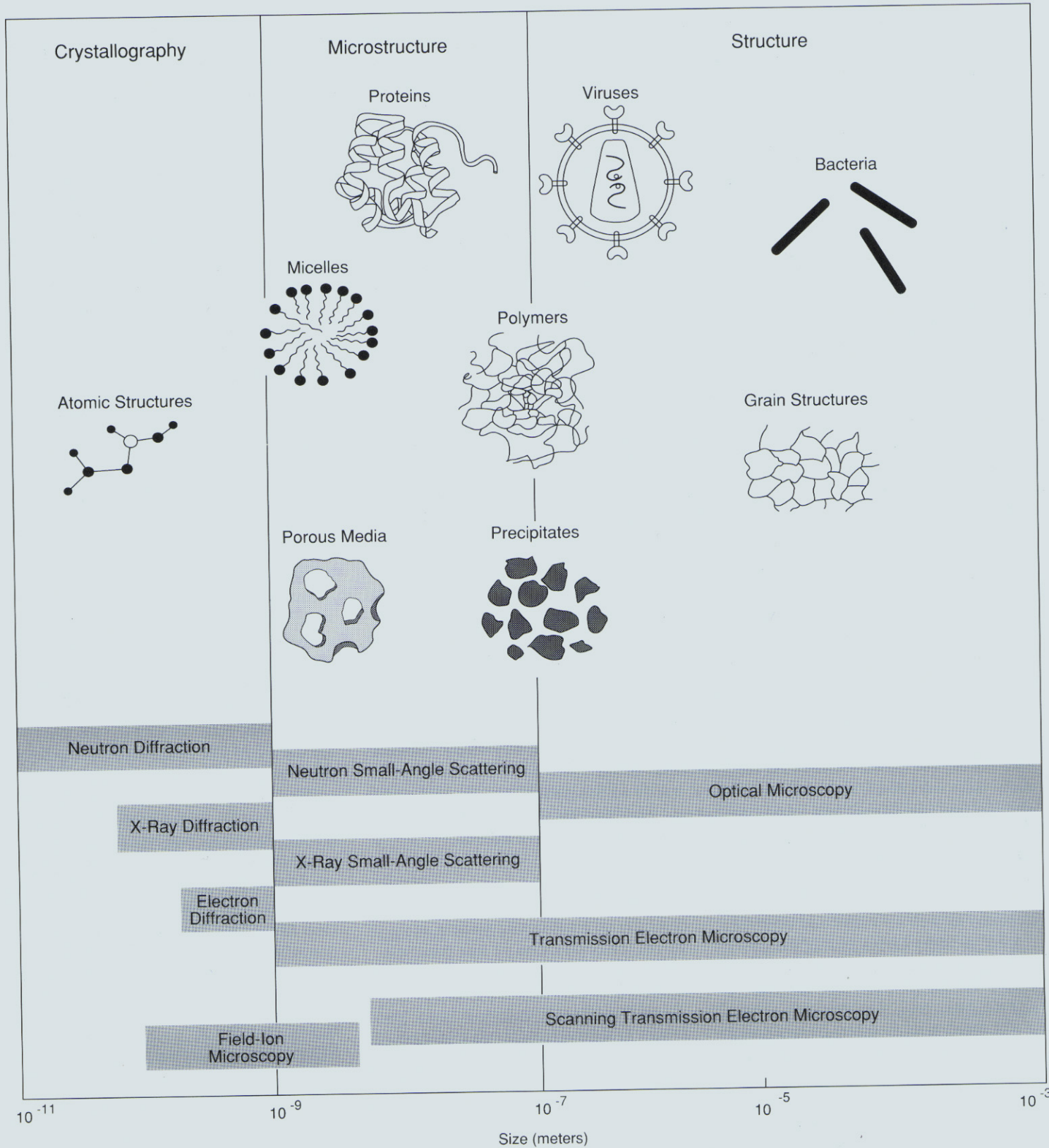

STRUCTURE PROBES

◀Fig. 3. A variety of techniques can be used to probe structure, but one of the main determining factors in the choice of a technique is the length scale of the structure being examined. Techniques range from neutron diffraction, which can be used to study atomic structure with length scales of 10^{-11} to 10^{-9} meter, to optical microscopy, which can be used to study bacteria and crystalline grain structures at much greater length scales.

terms of the wave functions of the neutron and the nucleus. The wave function of the neutron, as its name suggests, has the form of a wave—that is, a function that oscillates sinusoidally in space and time. The square of the amplitude of this wave at any point gives the probability that the neutron will be found at that point. It does not matter whether we talk about the wave that represents the neutron or the probability that a particle called the neutron is at a given location. Both descriptions will give rise to the same mathematics and are, therefore, equivalent. Sometimes it is convenient to refer to the neutron as a wave because the picture thus conjured is easier to understand. At other times it is more useful to think of the neutron as a particle. We can switch from one description to the other at will, and if we do the mathematics correctly, we will always get the same answer.

The neutrons used for scattering experiments usually have energies similar to those of atoms in a gas such as air. Not surprisingly, the velocities at which they move are also comparable with those of gas molecules—a few kilometers per second. Quantum mechanics tells us that the wavelength of the neutron wave is inversely proportional to the magnitude of the neutron velocity $v = |\mathbf{v}|$ (throughout the text we will use a bold variable to represent a vector quantity and a nonbold ver-

sion of the same variable to represent the corresponding magnitude). For the neutrons used in scattering experiments, the wavelength, λ , turns out to be a few angstroms (1 angstrom = 10^{-10} meter). It is often useful to work in terms of the so-called neutron wave vector, \mathbf{k} , which is a vector of magnitude $k = 2\pi/\lambda$ that points along the neutron's trajectory. The vectors \mathbf{k} and \mathbf{v} are collinear and related by the equation

$$\frac{h\mathbf{k}}{2\pi} = m\mathbf{v}, \quad (1)$$

where h is Planck's constant, m is the mass of the neutron (1.67495×10^{-27} kilogram), and $m\mathbf{v}$ is the momentum of the neutron.

The scattering of a neutron by a single nucleus can be described in terms of a *cross section* σ , measured in barns (1 barn = 10^{-28} square meter), that is equivalent to the effective area presented by the nucleus to the passing neutron. If the neutron hits this area, it is scattered isotropically, that is, with equal probability in any direction. Why isotropically? The range of the nuclear potential is tiny compared to the wavelength of the neutron, and so the nucleus is effectively a *point scatterer*. (X rays, on the other hand, do not scatter isotropically because the electron clouds around the atom scattering the x rays are comparable in size to the wavelength of the x rays.)

Suppose that at an instant in time we represent neutrons incident on a fixed nucleus by a wave function $e^{i\mathbf{k}\cdot\mathbf{r}}$, which is a plane wave of unit amplitude expressed in terms of the position vector \mathbf{r} . Note that the square modulus of this wave function is unity, which means the neutron has the same probability of being found anywhere in space but has definite momentum $m\mathbf{v} = h\mathbf{k}/2\pi$. The nodes of the wave—that is, the points at which the phase $\mathbf{k}\cdot\mathbf{r}$ is equal to $n\pi$, where n is an integer—are the straight

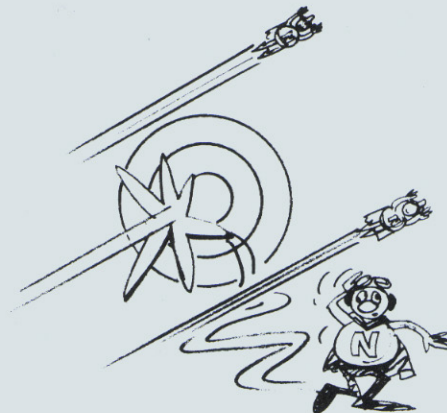

cross section

The effective area presented by a nucleus to an incident neutron. One unit for cross section is the barn, as in “can't hit the side of a barn!”

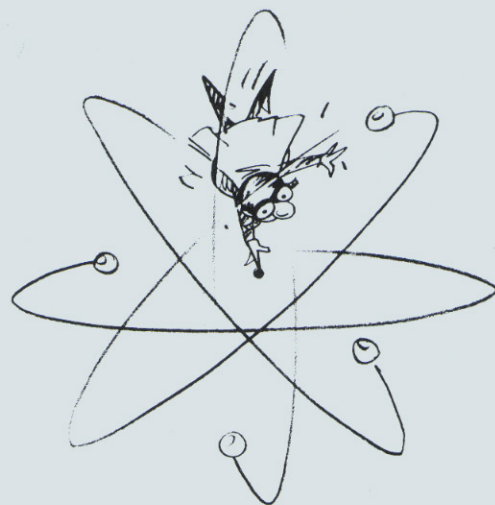

point scatterer

An object that scatters incident radiation isotropically by virtue of being very small compared with the wavelength of the radiation.

NEUTRON SCATTERING FROM A FIXED POINT

Fig. 4. A neutron beam incident on a single scattering center and traveling in the x direction can be represented as a plane wave e^{ikx} with unit amplitude. Because the neutron sees the scattering center (a nucleus) as a point, the scattering will be isotropic. As a result, the scattered neutron beam spreads out in spherical wavefronts (here drawn as circles) of amplitude b/r . The $1/r$ part of this amplitude factor, when squared to get intensity, accounts for the $1/r^2$ decrease in intensity with distance that occurs as the scattered wavefront grows in size. Because we have here taken the scattering center to be rigidly fixed, the interaction is elastic, there is no exchange of energy, and the incident and scattered wave vectors both have magnitude k . (To be rigorous, we should have included the time dependence $e^{i\omega t}$. But since the scattering is elastic, this factor is the same for the incident and scattered waves and cancels out of relative expressions, such as the one for the cross section.)

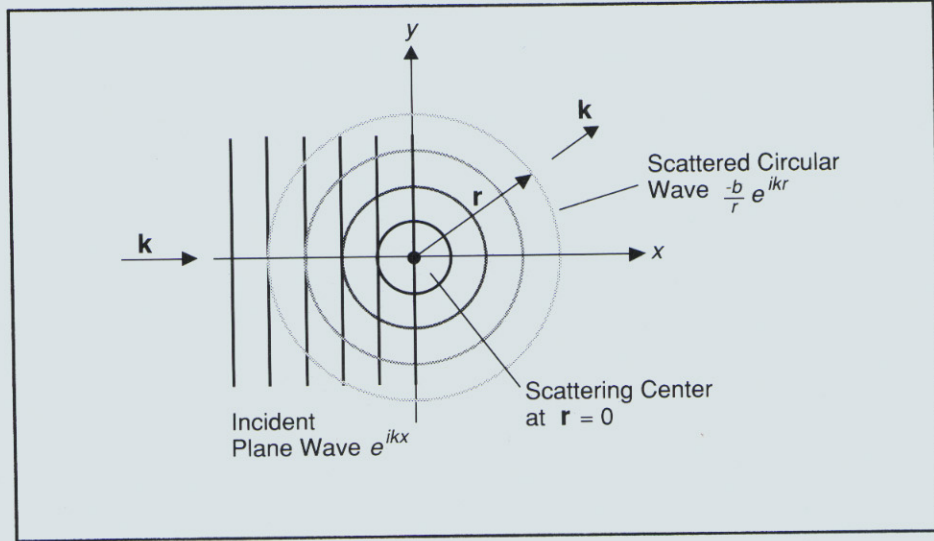

scattering length

A measure of the strength of the neutron-nucleus interaction, denoted by b and related to the cross section σ by $\sigma = 4\pi b^2$.

isotopic labeling

A technique that takes advantage of the considerable variation in scattering cross section among isotopes. By substituting one isotope for another (of either the same or a different element), the scattering from those constituents containing the substitute may be varied to reveal their positions relative to other constituents.

wavefronts shown in Fig. 4 (for a wave traveling in the x direction). In light of our earlier discussion, we ought to choose the amplitude of the neutron wave function (the constant multiplying the exponential) so that the amplitude squared gives a probability of finding a neutron at a position \mathbf{r} that is consistent with the number of neutrons in the beam we are using. However, since we shall be interested only in the ratio of the amplitudes of the incident and scattered neutron waves, we can set the amplitude of the incident wave to unity for the moment.

What is the amplitude of the neutron wave scattered by the nucleus? That depends on the strength of the interaction between the neutron and the nucleus. Because the scattered neutron wave is isotropic, its wave function can be written as $(-b/r)e^{ikr}$ if the scattering nucleus is at the origin of our coordinate system. The spherical wavefronts of the scattered neutron are represented by the circles spreading out from the nucleus in Fig. 4. The factor $(1/r)$ in the wave function of the scattered neutron takes care of the inverse square law that applies to all wave motions: the intensity of the neutron beam, given by the square of the amplitude of the

wave function, decreases as the inverse square of the distance from the source. In this case, the source is the scattering nucleus. The constant b , referred to as the *scattering length* of the nucleus, measures the strength of the interaction between the neutron and the scattering nucleus. The minus sign in the wave function means that b is a positive number for a repulsive interaction between neutron and nucleus.

For the type of collision being imagined here, the energy of the neutron is too small to change the internal energy of the scattering nucleus, and because we imagine the nucleus to be fixed, the neutron cannot impart kinetic energy. Thus, the scattering occurs without any change of the neutron's energy and is said to be *elastic*. Because the neutron energy is unchanged by a nuclear collision, the magnitude of its velocity and thus of its wave vector is also unchanged, and the same k appears in the wave function of the incident and the scattered neutrons.

What is the relationship between scattering length, b , and the cross section, σ , both of which are a measure of the strength of the scattering interaction? The cross section, σ , an area, is related to b , a length, by the simple relation

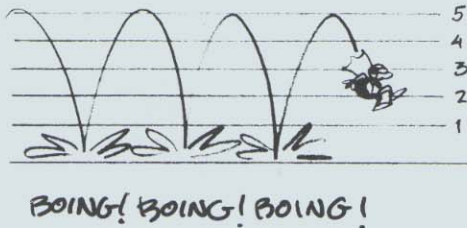

elastic scattering

Scattering with no change in the energy of the incident neutron; or, in terms of the wave vector of the neutron, scattering in which the direction of the vector changes but not its magnitude.

$\sigma = 4\pi b^2$ —as if the scattering length were half the radius of the nucleus as seen by the neutron.

For a few nuclei the scattering length, b , varies with the energy of the incident neutrons because compound nuclei with energies close to those of excited nuclear states are formed during the scattering process. This *resonance* phenomenon gives rise to complex values of b : the real part corresponds to scattering of the neutrons, whereas the imaginary part corresponds to absorption of the neutron by a nucleus. Usually, such resonant effects occur at neutron energies greater than those used to probe the structure of matter. In the majority of cases of interest to scientists doing neutron scattering, b is a real and energy-independent quantity. However, b has to be determined experimentally for each nuclear isotope because, unlike the equivalent quantity for x rays, the scattering length for neutrons cannot be calculated reliably in terms of fundamental constants.

Also unlike x rays, neutrons interact with atoms of an element in a manner that does not seem correlated with the atomic number of the element (as is evident in Fig. 1). In fact, the neutron's interaction with a nucleus of an atom varies from one isotope to another. For

example, hydrogen and deuterium, both of which interact weakly with x rays, have neutron scattering lengths that are relatively large and quite different. The differences in scattering lengths from one isotope to another can be used in various *isotopic-labeling* techniques to increase the amount of information available from a particular neutron-scattering experiment. We shall discuss isotopic labeling in more detail in the section on small-angle scattering.

Scattering of Neutrons by Matter

To work out how neutrons are scattered by matter, we need to add up the scattering from each of the individual nuclei. This is a lengthy and not particularly instructive quantum-mechanical calculation. Fortunately, the details of the calculation are not very important. The result is, however, both simple and appealing.

When neutrons are scattered by matter, the process can alter both the momentum and the energy of the neutrons and the matter. The scattering is not necessarily elastic as it is for a single, rigidly fixed nucleus because atoms in matter are free to move to some extent. They can therefore recoil during a collision with a neutron, or if they are moving when the neutron arrives, they can impart or absorb energy just as a baseball bat does.

As is usual in a collision, the total momentum and energy are conserved: when a neutron is scattered by matter, the energy lost by the neutron, ϵ , is gained by the sample. From Eq. 1 it is easy to see that the amount of momentum given up by the neutron during its collision, the *momentum transfer*, is $\frac{h}{2\pi}\mathbf{Q} = \frac{h}{2\pi}(\mathbf{k} - \mathbf{k}')$, where \mathbf{k} is the wave vector of the incident neutrons and \mathbf{k}' is that of the scattered neutrons. The quantity $\mathbf{Q} = \mathbf{k} - \mathbf{k}'$ is known as the *scattering vector*, and the vector relationship between \mathbf{Q} , \mathbf{k} , and \mathbf{k}' can be



inelastic scattering

Scattering in which exchange of energy and momentum between the incident neutron and the sample causes both the direction and the magnitude of the neutron's wave vector to change.



SCATTERING TRIANGLES

Fig. 5. Scattering triangles are depicted here for both (a) an elastic scattering event in which the neutron is deflected but the neutron does not lose or gain energy (so that $k' = k$) and (b) inelastic scattering events in which the neutron either loses energy ($k' < k$) or gains energy ($k' > k$) during the interaction. In both elastic and inelastic scattering events, the neutron is scattered through the angle 2θ , and the scattering vector is given by the vector relationship $\mathbf{Q} = \mathbf{k} - \mathbf{k}'$. For elastic scattering, a little trigonometry shows (lower triangle in (a)) that $Q = 4\pi \sin \theta / \lambda$.

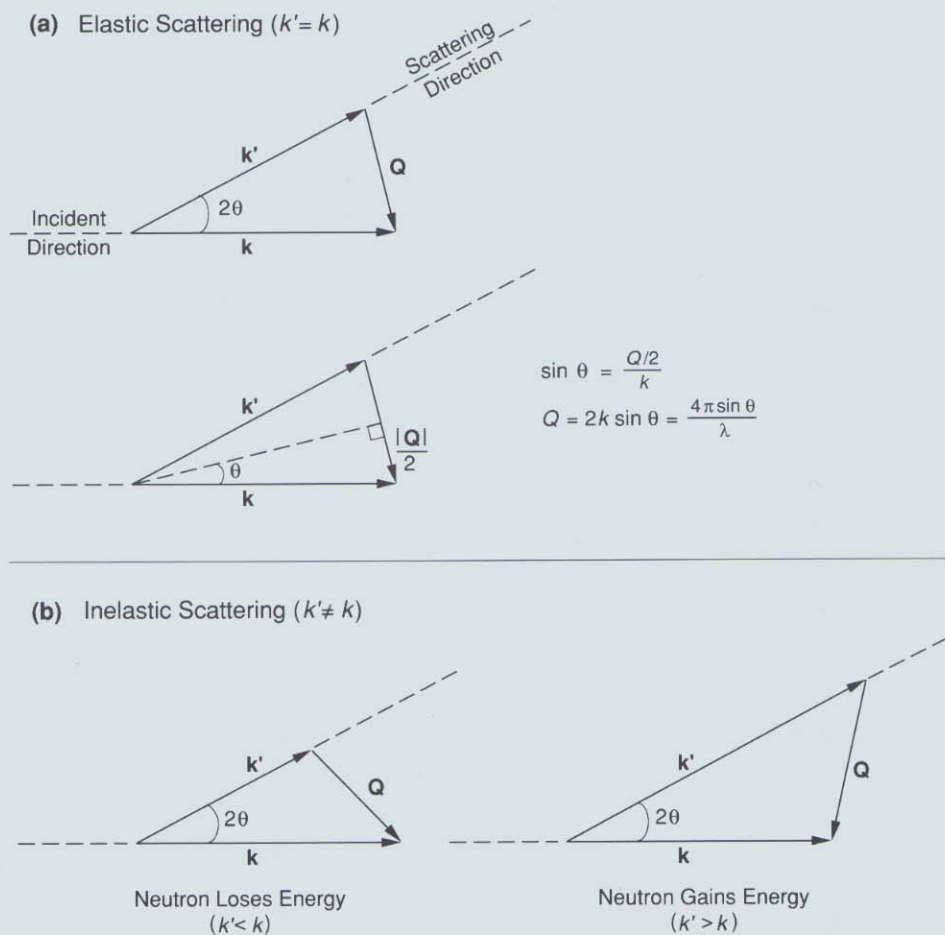

neutron-scattering law

The intensity of scattered neutrons as a function of the momentum and energy transferred to the sample during the scattering. The scattering law is written as $I(\mathbf{Q}, \epsilon)$, where $\frac{h}{2\pi} \mathbf{Q}$ is the momentum transfer, and ϵ is the energy transfer (see Eq. 3 in “The Mathematical Foundations of Neutron Scattering”).

displayed pictorially in the so-called *scattering triangle* (Fig. 5). This triangle also emphasizes that the magnitude and direction of \mathbf{Q} is determined by the the magnitudes of the wave vectors for the incident and scattered neutrons and the angle 2θ through which a neutron is deflected during the scattering process. Generally, 2θ is referred to as the *scattering angle*. For elastic scattering (Fig. 5a) $k = k'$, so $\epsilon = 0$, and a little trigonometry applied to the scattering triangle shows that $Q = 4\pi \sin \theta / \lambda$.

In *all* neutron-scattering experiments, scientists measure the intensity of neu-

trons scattered by matter (per incident neutron) as a function of the variables \mathbf{Q} and ϵ . This scattered intensity, denoted $I(\mathbf{Q}, \epsilon)$, is often referred to colloquially as the *neutron-scattering law* for the sample.

In a complete and elegant analysis, Van Hove showed in 1954 that the scattering law can be written exactly in terms of time-dependent correlations between the positions of *pairs* of atoms in the sample (see “The Mathematical Foundations of Neutron Scattering” for a more detailed discussion). Van Hove’s result implies that $I(\mathbf{Q}, \epsilon)$ is simply pro-

portional to the Fourier transform of a function that gives the probability of finding two atoms a certain distance apart. It is the simplicity of this result that is responsible for the power of neutron scattering. If nature had been unkind and included correlations between triplets or quadruplets of atoms in the expression for the scattering law, neutron scattering could never have been used to probe directly the structure of materials.

Of course, we have not yet explained *how* one may measure the intensity of scattered neutrons as a function of \mathbf{Q} and ϵ , but *if* we can do that, Van Hove's result provides a way of relating the intensity of the scattered neutrons to the relative positions and the relative motions of atoms in matter. In fact, Van Hove's formalism can be manipulated (see "The Mathematical Foundations of Neutron Scattering") to reveal scattering effects of two types. The first is *coherent scattering* in which the neutron wave interacts with the whole sample as a unit so that the scattered waves from *different* nuclei interfere with each other. This type of scattering depends on the relative distances between the constituent atoms and thus gives information about the structure of materials. *Elastic* coherent scattering tells us about the equilibrium structure, whereas *inelastic* coherent scattering (with $\epsilon \neq 0$) provides information about the collective motions of the atoms, such as those that produce vibrational waves in a crystalline lattice. In the second type of scattering, *incoherent scattering*, the neutron wave interacts independently with each nucleus in the sample so that the scattered waves from different nuclei *don't* interfere. Rather the intensities from each nucleus just add up. Incoherent scattering may, for example, be due to the interaction of a neutron wave with the *same* atom but at different positions and different times, thus providing information about atomic diffusion.

Diffraction, or Bragg Scattering

The simplest type of coherent neutron scattering to understand is diffraction. Suppose that atoms are arranged at fixed positions on a lattice (such as the two-dimensional portion of the lattice shown in Fig. 6) and a beam of neutrons is fired at that lattice. We imagine that all of the neutrons move on parallel paths and have the same velocity, so that there is only one value for the incident wave vector, \mathbf{k} . Because the atoms and their associated nuclei are imagined to be fixed, there is no change in the neutron's energy during the scattering process; that is, the scattering is elastic and $k' = k$.

As the incident neutron wave arrives at each atom, the atomic site becomes the center of a scattered spherical wave that has a definite phase relative to all other scattered waves. In two dimensions, it is as if a handful of pebbles have been thrown into a calm pond. At the point where each pebble strikes the pond (the atomic site), a circular wave spreads outwards. Because the waves from each site overlap there will be places where the disturbances from different waves reinforce one another and other places where they cancel out. This is the phenomenon of interference.

As the waves spread out from a regular array of sites, the individual disturbances will reinforce each other only in particular directions. In other words, if we observe the wave motion at some distance from the lattice, we will see waves (scattered neutrons) traveling in well-defined directions (Fig. 6). These directions are closely related to the symmetry and spacing (or lattice) of the scattering sites—a hexagonal grid will generate a different set of wavefronts than a square grid. Consequently, one may use a knowledge of the directions in which various incident waves are scattered to deduce both the symmetry of the lattice and the distances between



coherent scattering

Scattering in which an incident neutron wave interacts with all the nuclei in a sample in a coordinated fashion; that is, the scattered waves from all the nuclei have definite relative phases and can thus interfere with each other.



incoherent scattering

Scattering in which an incident neutron wave interacts independently with each nucleus in the sample; that is, the scattered waves from different nuclei have random, or indeterminate, relative phases and thus cannot interfere with each other.

diffraction

A type of scattering in which coherently scattered waves interfere.

DIFFRACTION FROM A LATTICE

Fig. 6. As a neutron (represented in the figure by a plane wave) passes through a lattice of regularly spaced scattering centers (rather than the single scattering center of Fig. 4), the spherical wavefronts that represent scattered neutrons will overlap and interfere with each other. In those directions in which the interference is constructive, scattered neutrons may be measured. The figure depicts such constructive interference in *two* dimensions with planar wavefronts represented as lines, spherical wavefronts as colored circles, and the scattering centers as small circles. To simplify the diagram, the scattering is shown only for four centers (solid black) in each of the two rows of scattering planes. Also, color is used to relate each incident wavefront to the scattered wavefronts that have so far been generated by it. Thus, the incident red wavefront has passed over and scattered from four scattering centers in Scattering Plane 1; the orange wavefront has passed over and scattered from these scattering centers *plus* the leftmost scattering center in Scattering Plane 2; the yellow wavefront has passed over all eight scattering centers in both planes. For constructive interference to take place, $Q \cdot (r_j - r_k) = Qd = 2\pi n$ must be satisfied, where $|r_j - r_k| = d$ is the distance between the two scattering planes and n is an integer. Combining this condition with $Q = 4\pi \sin \theta / \lambda$ (from Fig. 5a) yields Bragg's law: $n\lambda = 2d \sin \theta$.

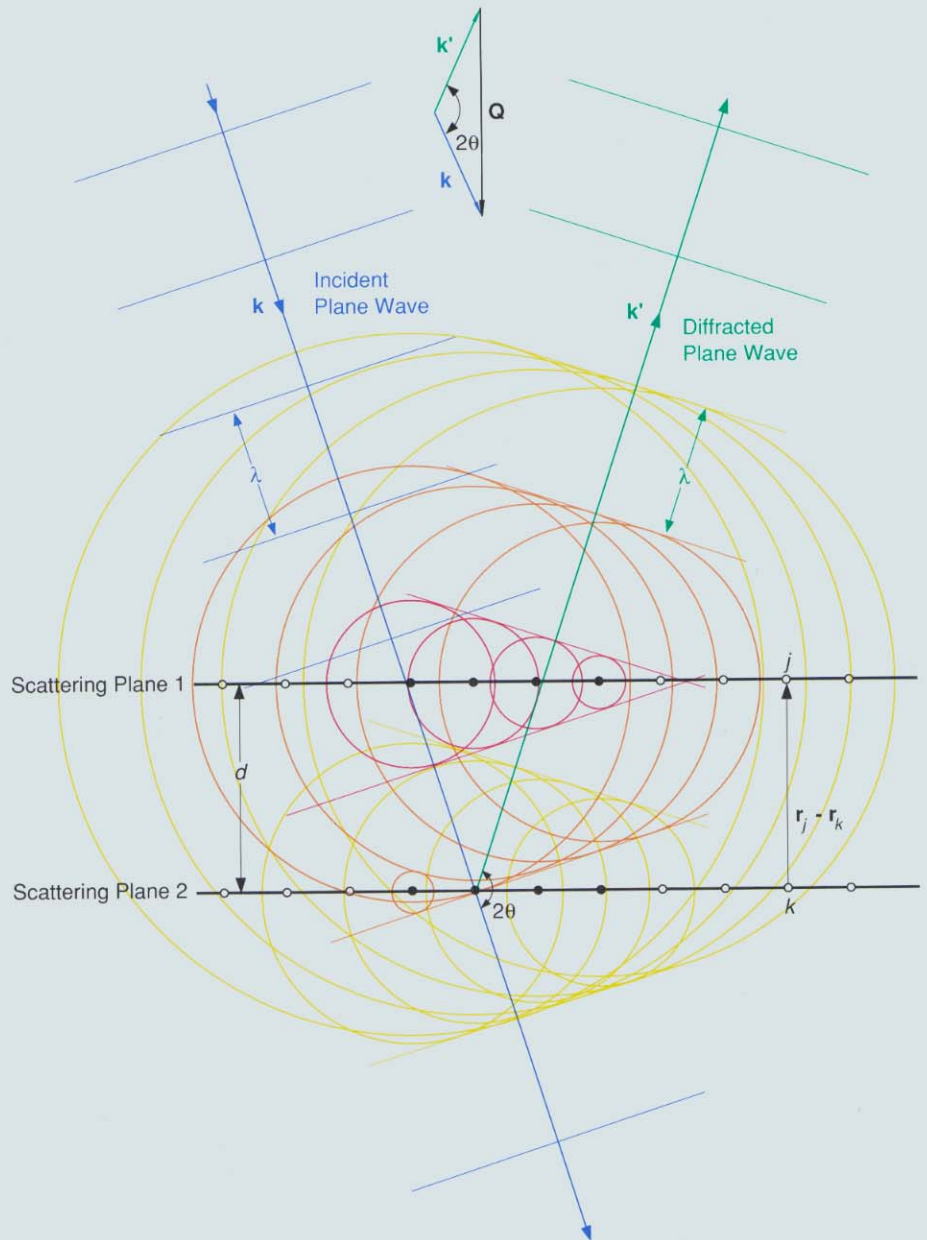

atoms. The type of scattering we have just described is called *diffraction*.

Because diffraction is an elastic, coherent scattering process, Van Hove's formulation of the scattering law reduces to a simple form. For a three-dimensional lattice with one isotope, the scattering law can be written (see "The Mathematical Foundations of Neutron

Scattering") as

$$\begin{aligned}
 I(\mathbf{Q}) &= \sum_{j,k} b_{\text{coh}}^2 e^{i\mathbf{Q}\cdot(\mathbf{r}_j - \mathbf{r}_k)} \\
 &= \left| \sum_j b_{\text{coh}} e^{i\mathbf{Q}\cdot\mathbf{r}_j} \right|^2 \quad (2) \\
 &\equiv S(\mathbf{Q}),
 \end{aligned}$$

where \mathbf{r}_j and \mathbf{r}_k represent the positions of atoms labeled j and k in the lattice and b_{coh} is the coherent scattering length of those atoms.

Equation 2 is the scattered intensity that would be measured in a neutron-diffraction experiment with a real crystal, and is often called the *structure factor*, $S(\mathbf{Q})$. As we count through the atoms of a lattice performing the sum in Eq. 2, the real and imaginary parts of the exponential function both take values that are distributed essentially at random between plus and minus one. Because many atoms are involved, the sum usually averages to zero, except at certain unique values of \mathbf{Q} .

Obviously, the values of \mathbf{Q} for which the structure factor, $S(\mathbf{Q})$, is nonzero are rather special, and it is easy to imagine that not many values of \mathbf{Q} satisfy this condition. Further, those values are intimately related to the structure of the crystal because the vectors $\mathbf{r}_j - \mathbf{r}_k$ in Eq. 2 represent the set of distances between different atoms in the crystal.

We can determine the values of \mathbf{Q} at which $S(\mathbf{Q})$ is nonzero and at which diffraction occurs by consulting Fig. 6. Suppose \mathbf{Q} is perpendicular to a plane of atoms such as Scattering Plane 1 in this figure. If the value of \mathbf{Q} is any integral multiple of $2\pi/d$, where d is the distance between parallel, neighboring planes of atoms (Scattering Planes 1 and 2 in Fig. 6), then $\mathbf{Q} \cdot (\mathbf{r}_j - \mathbf{r}_k)$ is a multiple of 2π and $S(\mathbf{Q})$ is nonzero because each exponential term in the sum in Eq. 2 is unity. Thus, \mathbf{Q} must be perpendicular to *planes* of atoms in the lattice and its value must be an integral multiple of $2\pi/d$. For values of \mathbf{Q} that do not satisfy this condition, $S(\mathbf{Q}) = 0$, and there is no scattering.

The values of \mathbf{Q} at which neutron diffraction occurs are governed by the same law that was discovered for x rays in 1912 by William and Lawrence Bragg, father and son. To see this, we apply the condition described above

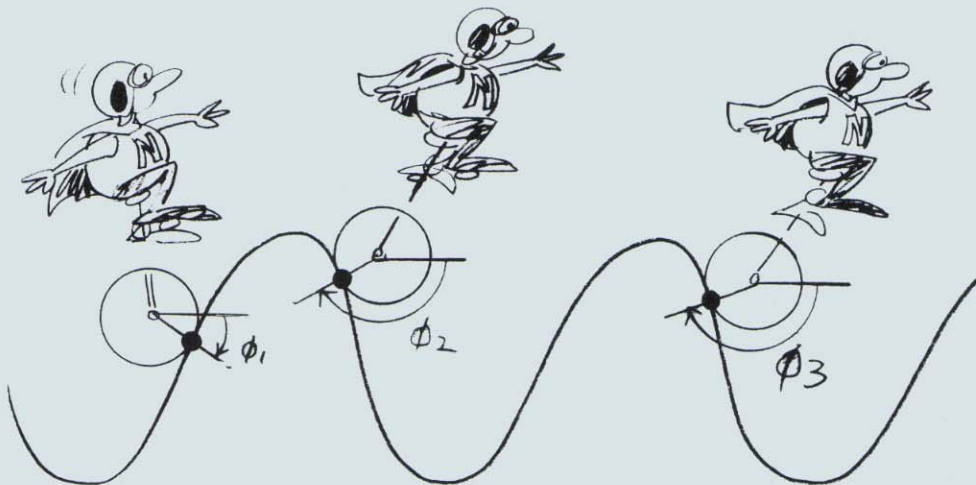

($Q = n(2\pi/d)$, where n is an integer) to the scattering triangle for elastic scattering. Then using the relationship between Q , θ , and λ shown in Fig. 5, the condition can be rewritten as

$$n\lambda = 2d \sin \theta. \quad (3)$$

This equation, called *Bragg's law*, relates the scattering angle, 2θ , to the interplanar spacing in a crystalline sample.

Bragg's law can also be understood in terms of the path-length difference between waves scattered from neighboring planes of atoms (Fig. 7). For constructive interference to occur between waves scattered from adjacent planes, the path-length difference must be a multiple of λ , the wavelength. Applying this condition to Fig. 7 immediately yields Bragg's law in the form given in Eq. 3. Many of the results described in the articles in this issue will fall back on this point of view.

Diffraction, or Bragg scattering, as it is sometimes called, may occur for any set of atomic planes that we can imagine in a crystal, provided the wavelength, λ , and the angle, θ , between the incident neutron beam and the planes are chosen to satisfy Eq. 3. Bragg scattering from a particular set of atomic planes resembles reflection from a mir-

relative phase

The phase angle $\phi = \mathbf{k} \cdot \mathbf{r} \pmod{2\pi}$ appears in the expression $Ae^{i\mathbf{k} \cdot \mathbf{r}}$ describing a plane wave of amplitude A . For a plane wave traveling in the x direction with wave vector $k_x = 2\pi/\lambda$, we can write the phase as $\phi = \frac{2\pi x}{\lambda} \pmod{2\pi}$. Thus as the wave travels a distance λ , its phase changes by 2π . When two waves with wave vector \mathbf{k} and equal amplitude A are in phase, their phases at any point in space are the same and the waves add constructively to yield an intensity of $4A^2$. When the relative phase ($\phi_1 - \phi_2$) of two waves is nonzero, the waves will interfere with each other so that their resulting intensity fluctuates in space and is always less than $4A^2$. Incoherent scattering produces random changes in the phase of the incident wave so that the relative phases of the scattered waves are indeterminate, the waves do not interfere with each other, and the intensity of each wave is added separately to yield the total intensity.

THE PATH-DIFFERENCE APPROACH TO BRAGG'S LAW

Fig. 7. Constructive interference occurs when the waves reflected from adjacent scattering planes remain in phase. This happens when the difference in distance traveled by waves reflected from adjacent planes is an integral multiple of the wavelength. The figure shows that the extra distance (shown in red) traveled by the wave reflected from Scattering Plane 2 is $2d \sin \theta$. When that distance is set equal to $n\lambda$, the result is, once again, Bragg's law: $n\lambda = 2d \sin \theta$. Primary scattering occurs when $n = 1$, but higher-order Bragg peaks are also observed for other values of n .

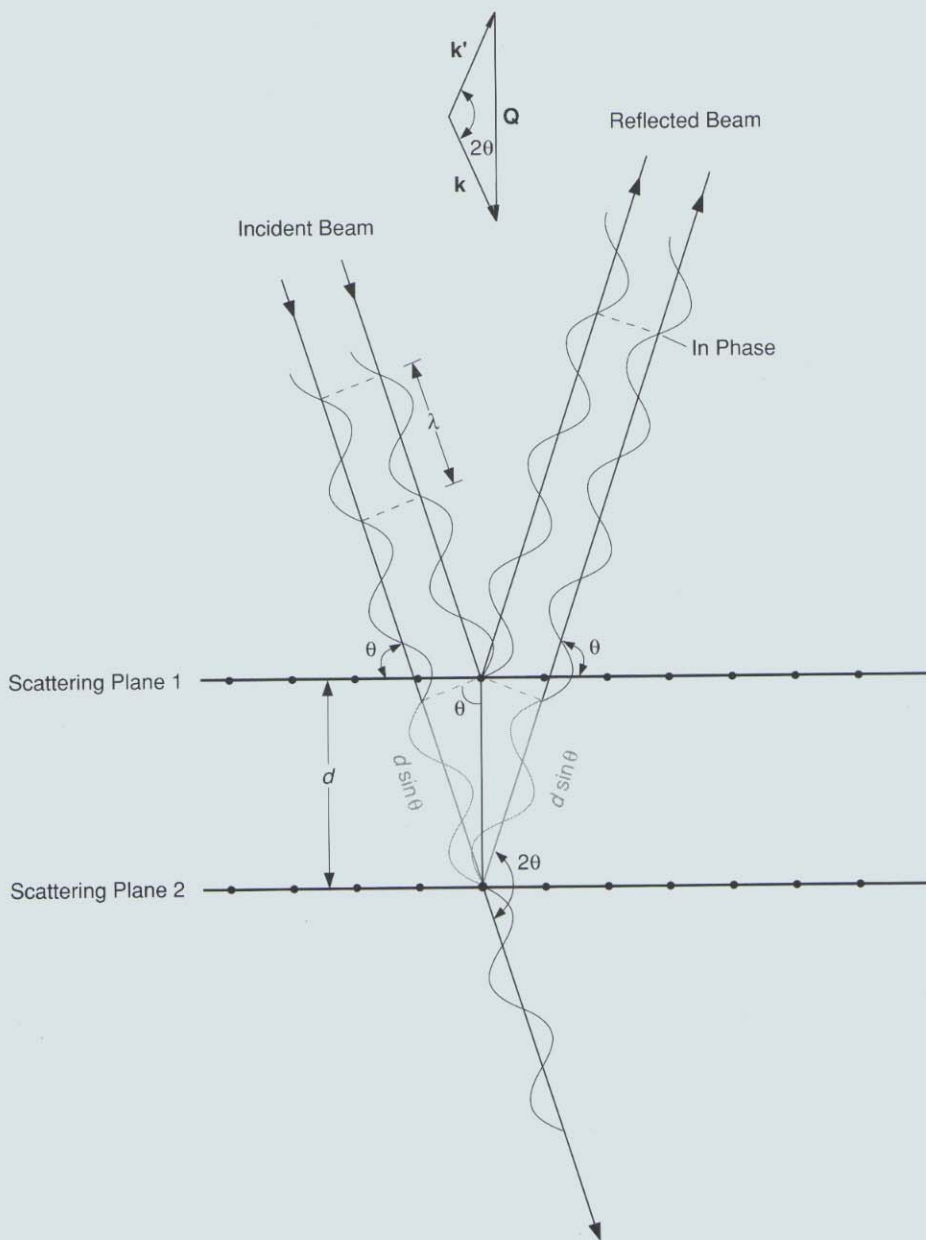

ror parallel to those planes: the angle between the incident beam and the plane of atoms equals the angle between the scattered beam and the plane (Fig. 7). If a beam of neutrons of a particular wavelength is incident on a single crystal, there will, in general, be no diffraction. To obtain diffraction for a set of planes, the crystal must be rotated to the correct orientation so that Bragg's law is satisfied—much as a mirror is adjusted

to reflect the sun at someone's face. The signal thus observed by a neutron detector at a particular scattering angle is called a Bragg peak because as we rotate the crystal to obtain diffraction we observe a peak in the signal being recorded.

According to Eq. 2, the intensity of the scattered neutrons is proportional to the square of the density of atoms in the atomic planes responsible for the

scattering. We can see this by noting that as the summation is carried out for each atom j in one plane, unit exponential factors are added for all the atoms k in another plane. And the more closely the atoms are spaced within a reflecting plane, the more unit factors will be summed per unit area. Thus, an observation of Bragg peaks allows us to deduce both the spacing of planes (from Bragg's law) and the density of the atoms in the planes. To measure Bragg peaks corresponding to many different atomic planes with neutrons of a particular wavelength, we have to vary both the scattering angle, 2θ , and the crystal orientation. First we choose the detector position so that the scattering angle satisfies Bragg's law, then we rotate the crystal until a Bragg diffracted beam falls on the detector.

To this point we have been discussing a simple type of crystal that can be built from *unit cells*, or building blocks, that each contain only one atom. In this case, each of the exponential factors that contribute to $S(\mathbf{Q})$ in Eq. 2 is unity, and the structure is easily deduced from the intensities of the Bragg peaks and the scattering angles at which Bragg diffraction occurs. However, the unit cells of materials of interest to chemists or biologists almost invariably have more complicated shapes and contain many different types of atoms distributed throughout their volumes. Those atoms, of course, are not positioned randomly in the unit cell but are arranged in a geometric pattern determined by the way they bond together. Nevertheless, it may not be trivial to deduce the atomic positions from an observation of Bragg scattering because some of the exponential factors that contribute to $S(\mathbf{Q})$ are now complex and the phases of these quantities cannot be obtained directly from a measurement of Bragg diffraction. Deducing the structure of a complex material may take several months and a great deal of ingenuity.

In diffraction experiments with single crystals, the sample must be correctly oriented with respect to the neutron beam to obtain Bragg scattering. Furthermore, if neutrons of a single wavelength are used, the detector must also be positioned at the appropriate scattering angle for the atomic planes causing the scattering. On the other hand, polycrystalline powders, which consist of many randomly oriented single-crystal grains, will diffract neutrons whatever the orientation of the sample relative to the incident beam of neutrons. There will always be grains in the powder that are correctly oriented to diffract. Thus, whenever the scattering angle, 2θ , and the neutron wavelength, λ , satisfy the Bragg equation (Eq. 3) for a set of planes, a reflection will be detected, independent of the sample orientation. This observation is the basis of a widely used technique known as *powder diffraction*, which is implemented in slightly different ways depending on the nature of the neutron source. Before describing powder diffraction in greater detail, we digress to consider the different techniques that may be used to produce neutrons for scattering experiments.

Neutron Production

Neutron-scattering facilities throughout the world generate neutrons either with nuclear reactors or with high-energy particle accelerators. The neutrons produced have energies up to tens or even hundreds of mega-electron volts (MeV), and the corresponding neutron wavelengths are far too short for investigating condensed matter. Furthermore, neutrons whose energies are above a few electron volts tend to damage solids by knocking atoms out of their official positions, producing vacancies and interstitials. For this reason, neutrons must be "cooled down" before being used for scattering experiments.

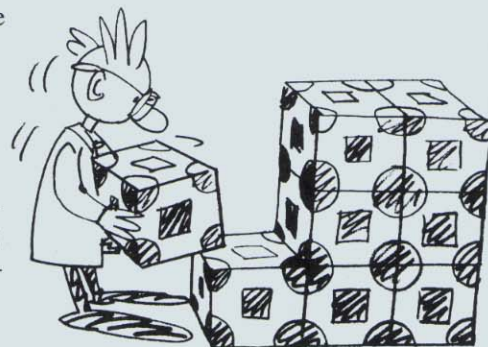

unit cell

The repeating unit of a crystal.



cold neutrons

Neutrons whose energies have been reduced below about 5 meV by inelastic scattering in a cold material such as liquid hydrogen or deuterium. Researchers use such longer-wavelength neutrons to conduct experiments at larger length scales.

Such cooling is done by bringing the neutrons into thermal equilibrium with a “moderating” material—a material with a large scattering cross section, such as water or liquid hydrogen. The moderator, whose volume may vary from a deciliter to several tens of liters, is placed close to the neutron source. Neutrons enter the moderator and, in a series of collisions in the material, lose energy to recoiling moderator atoms. After a few tens of collisions, the energies of the neutrons are similar to those of the atoms of the moderator. Thus, *thermal* neutrons are emitted from the moderator surface with a spectrum of energies around an average value determined by the moderator temperature. The average energy of neutrons from a water moderator at ambient temperature is about 25 thousandths of an electron volt (25 meV), and the average energy from a liquid-hydrogen moderator at 20 kelvins is around 5 meV. The wavelength of a 25-meV neutron is 1.8 angstroms (1.8×10^{-10} meter), which is of the same order as typical interatomic distances and, therefore, is quite suitable for diffraction experiments.

Reactor Sources. Neutrons are produced in a nuclear reactor by the fissioning of atoms in the reactor fuel, which, for research reactors, is invariably uranium. The neutrons are moderated in the manner described above and allowed to emerge from the reactor in a continuous stream with an energy spectrum similar to the curves of Fig. 8a.

For most scattering experiments at reactors, the neutrons emerging from the moderator must be reduced to a *monochromatic* beam; that is, only those neutrons in a single, narrow energy band are selected from the spectrum. This selection is usually accomplished by Bragg reflection from a large single crystal of a highly reflective material, such as pyrolytic graphite, germanium, or copper. A crystal monochromator

(a) Reactor Neutrons

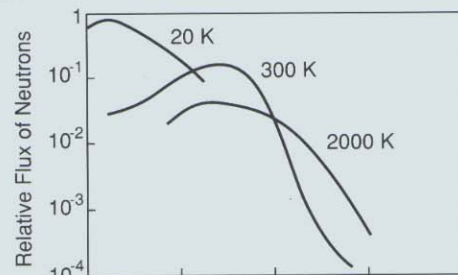

(b) Spallation Neutrons

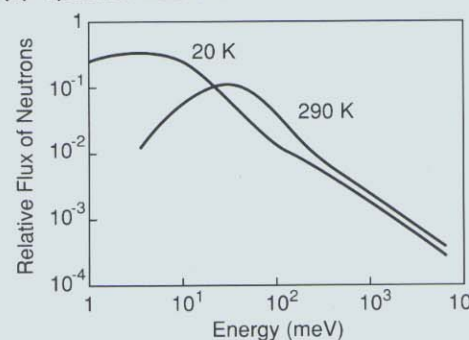

REACTOR AND SPALLATION NEUTRONS

Fig. 8. (a) The relative flux of neutrons as a function of energy for the high-flux reactor at the Institut Laue-Langevin in Grenoble, France. The curves show the distribution of neutrons emerging from moderators at temperatures of 20, 300, and 2000 kelvins. (b) Similar distribution curves for neutrons generated at the Manuel Lujan, Jr. Neutron Scattering Center at Los Alamos (LANSCE) by moderators at temperatures of 20 and 290 kelvins.

works because, even though the incident beam contains neutrons of many wavelengths, the spacing of the reflecting planes of atoms, d , and the scattering angle, 2θ , are chosen so that only those neutrons with a wavelength satisfying the Bragg equation are transmitted in the direction of the experiment. The wavelength of the neutrons used for experiments can then be controlled by changing the scattering angle at the monochromator.

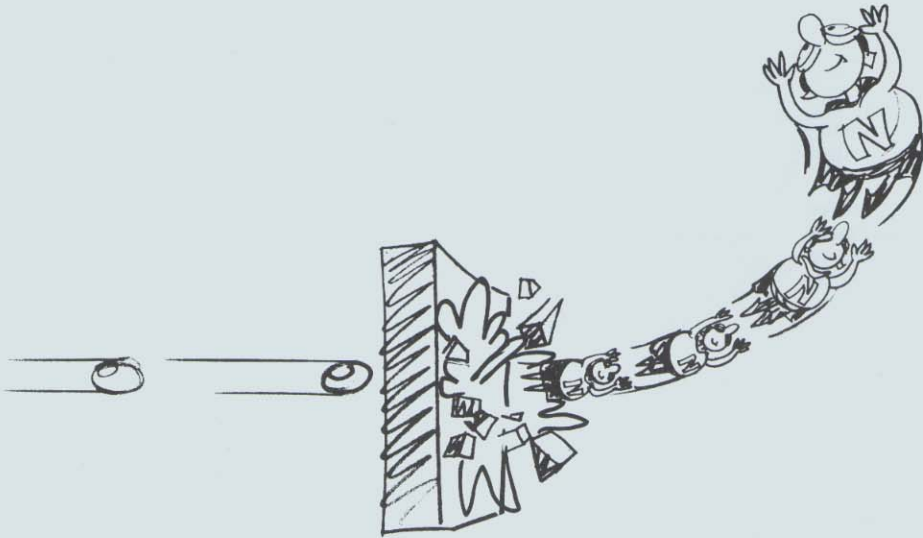

spallation neutrons

Neutrons generated at an accelerator by driving a highly energetic beam of particles, typically protons, into a target of heavy atoms, such as tungsten. The incident protons knock neutrons loose from the nuclei of the target, creating a pulse of highly energetic spallation neutrons.

Spallation Sources. Other neutron facilities, such as the one at the Manuel Lujan, Jr. Neutron Scattering Center at Los Alamos (LANSCE), use accelerators to produce *spallation* neutrons. This is done by allowing high-energy protons (or, less effectively, electrons) to collide with a heavy-metal target, such as tungsten or uranium, driving neutrons from the nuclei of the target. The protons are produced by the accelerators—in this case, LAMPF (the Los Alamos Meson Physics Facility) coupled with a proton storage ring—in bursts that last for less than a microsecond. At LANSCE there are 20 such bursts of 800-MeV protons per second. Each proton in the burst then generates about 20 neutrons.

One of the advantages of a spallation source is that only a small amount of energy—about 27 MeV per neutron—is deposited in the spallation target by the protons. Nuclear fission produces about four or five times as much energy in generating each of its neutrons. However, the cost of producing the high-energy protons—the electricity bill of the accelerators—is not cheap.

The moderated neutrons that finally emerge into the experimental area from a spallation source have a spectrum resembling the curves of Fig. 8b. Clearly, this spectrum is quite different from

that produced by a reactor (Fig. 8a) because there is a greater percentage of high-energy neutrons. However, the spectrum is not the only difference between the two types of neutron sources. Neutrons from a spallation source arrive in pulses rather than continuously as they do at a reactor. This fact means that the monochromator crystal needed at reactors can here be avoided and *all* the neutrons can be used (rather than only those in a narrow energy band).

The trick that allows the use of all neutrons from a spallation source relies on the measurement of the time it takes for each detected neutron to traverse the distance between the moderator and the detector. From this *time of flight*, the neutron velocity can be determined, and Eq. 1 gives its wavelength. Generating a monochromatic beam is therefore unnecessary.

A thermal neutron with an energy of 25 meV travels at a speed of about 2.2 kilometers per second, or about Mach 7. A typical neutron spectrometer is about 10 meters long, so the neutron travels from the moderator to the detector in about 5 milliseconds. Because the duration of the neutron pulse emerging from the moderator of a pulsed source is typically a few tens of microseconds, the time of flight of the neutron can be determined with high relative precision.

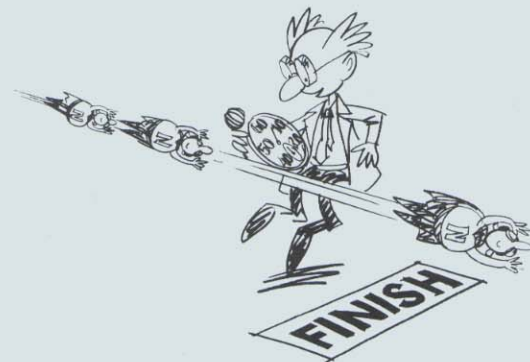

time of flight

The time it takes a neutron to travel from a pulsed source to a detector, which is thus a measure of the neutron's velocity and kinetic energy.

Powder Diffraction

Now let's return to powder diffraction. In a powder-diffraction instrument at a reactor source (Fig. 9), a monochromatic beam of neutrons impinges on a powdered sample, and the neutrons scattered from the sample are recorded as a function of the angle 2θ . Each Bragg peak in a typical scattering pattern (Fig. 10) corresponds to diffraction from atomic planes with a different interplanar spacing, or value of d . Many peaks can be recorded simultaneously by placing detectors at a variety of scattering angles (such as the sixty-four helium-3 detectors in Fig. 9).

In a powder diffraction instrument at a spallation source (Fig. 11), the sample is irradiated with a pulsed beam of neutrons having a wide spectrum of energies. Scattered neutrons are recorded in banks of detectors located at different scattering angles, and the time at which each scattered neutron arrives at the detector is also recorded. At a particular scattering angle, the result is a diffraction pattern very similar to that measured at a reactor, but now the independent variable is the neutron's time of flight rather than the scattering angle. Because the neutron's time of flight is proportional to its wavelength and, for constant scattering angle, wavelength is proportional to the spacing between atomic planes (Eq. 3), the measured neutron scattering can be plotted against either time of flight, λ , or d -spacing (Fig. 12). (The resemblance between Figs. 10 and 12 is obvious. The patterns are equivalent ways of probing Bragg's law, and in fact, diffraction data obtained at reactors and spallation sources can be plotted on the same scale by simply using $Q = 4\pi \sin \theta / \lambda$ as the independent variable.)

As in the reactor case, detectors at a spallation source can be placed at different scattering angles, allowing many patterns to be measured simultaneously.

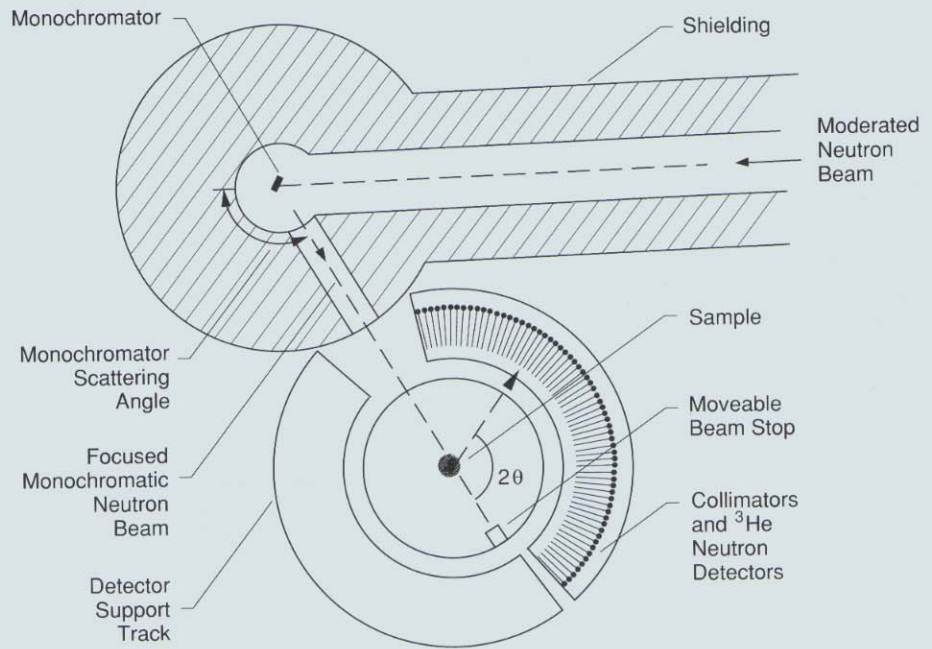

POWDER DIFFRACTION AT A REACTOR SOURCE

Fig. 9. An essential component of a powder diffractometer at a high-flux reactor is a very large crystal whose reflecting surface may be as large as 200 square centimeters. The crystal acts as a monochromator by scattering neutrons of a given energy toward the sample. To help focus the beam of neutrons, the crystal may also be curved, effectively acting as a concave mirror. A second scattering occurs at the powder sample, which scatters the monoenergetic focused beam toward a set of detectors (here, 64 helium-3 neutron detectors). These detectors are here shown positioned along an arc on one side of the sample, but the whole array can be moved to other positions along the circular support track. The distance between the monochromator and the sample is typically about 2 meters.

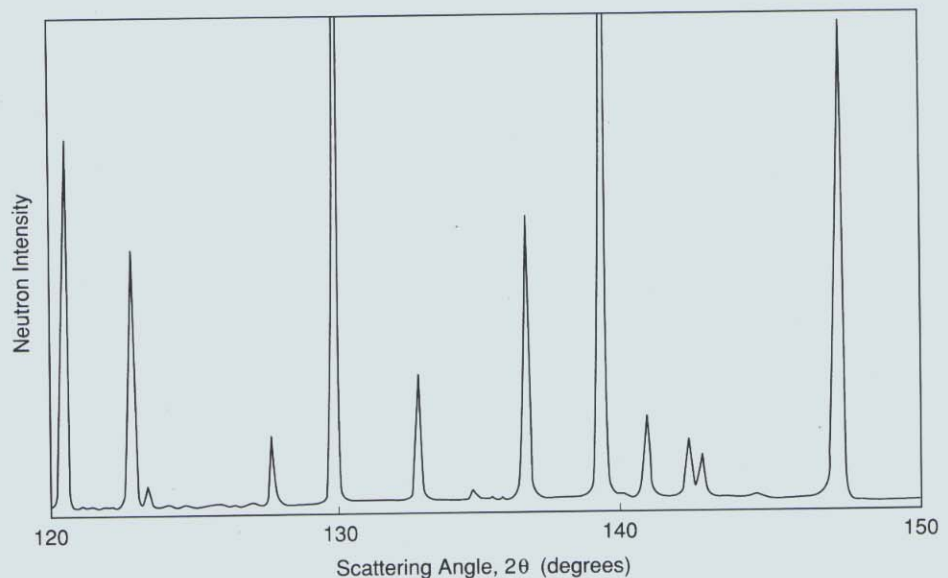

A POWDER DIFFRACTION PATTERN RECORDED AT A REACTOR

Fig. 10. A typical powder diffraction pattern obtained at a reactor source gives intensity, or numbers of neutrons, as a function of the scattering angle 2θ . Each peak represents neutrons that have been scattered from a particular set of atomic planes in the crystalline lattice.

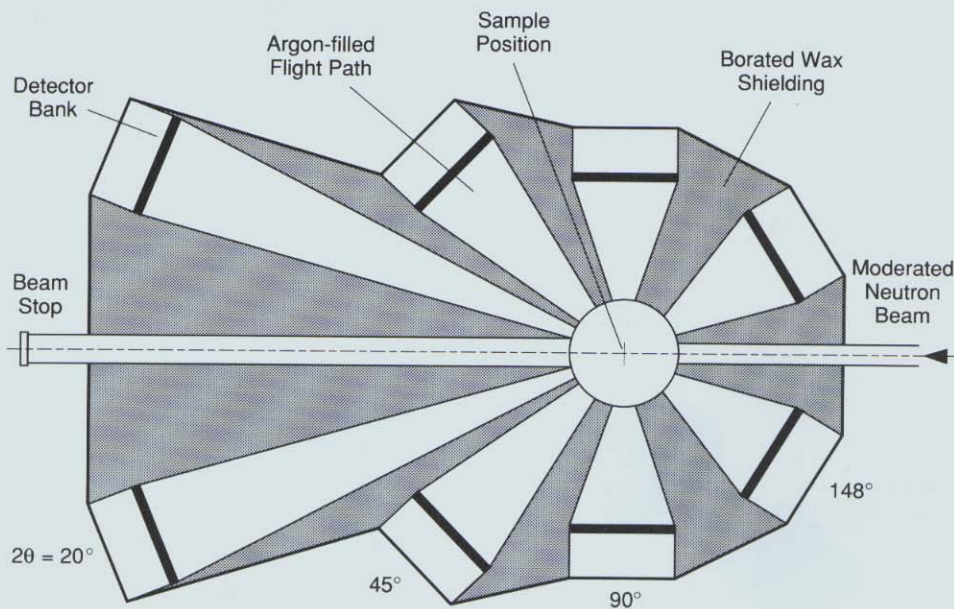

POWDER DIFFRACTION AT A SPALLATION SOURCE

Fig. 11. The Neutron Powder Diffractometer (NPD) at LANSCE (see photograph on page 54). The incident beam of neutrons, having been moderated with water chilled to 10°C, is directed onto the target in a large evacuated chamber. Surrounding this chamber are eight banks of detectors positioned at fixed scattering angles. Each bank consists of sixteen helium-3 detectors, and the d -spacing that can be measured ranges from about 1.2 to 33.6 angstroms at the 20° detector bank to about 0.25 to 5.2 angstroms at the 148° detector bank. The distance between the sample and the detectors at the 90° scattering angle is about 2 meters, so the whole spectrometer is very much larger than the equivalent instrument at a reactor.

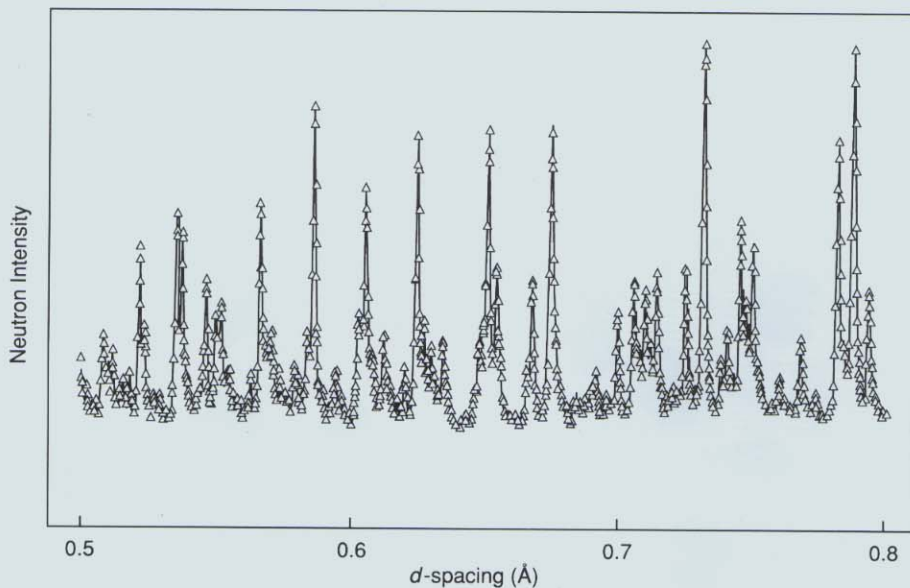

A POWDER DIFFRACTION PATTERN RECORDED AT A SPALLATION SOURCE

Fig. 12. A typical powder diffraction pattern obtained at a spallation source ("fat garnet" measured at one of the 148° bank of detectors in the diffractometer of Fig. 11). As in Fig. 10, the vertical coordinate is the intensity, or number of neutrons, but the horizontal coordinate is the d -spacing between atomic planes. The horizontal variable could as well be λ (via Bragg's law, Eq. 3) or the neutron time of flight (via Eqs. 1 and 3).

Detectors at small scattering angles provide information about widely spaced atomic planes, whereas those at larger angles record data relevant to small spacings. There is usually some overlap of information provided by the different detectors.

Using patterns like those of Figs. 10 and 12, the atomic structure of a polycrystalline sample may be deduced from Eq. 2. In practice, however, one guesses the atomic positions, evaluates Eq. 2, and from a comparison of the calculated and measured diffraction patterns, refines the atomic coordinates. This type of procedure is described in detail in the article "X-Ray and Neutron Crystallography—A Powerful Combination" by Robert Von Dreele.

Probing Larger Structures

Another way of thinking about coherent elastic neutron scattering is shown in Fig. 13. One can imagine the incident and scattered neutron waves setting up a "probe wave" in the sample—much as two misaligned picket fences generate a set of moiré fringes. One can alter the wavelength of the probe wave, λ_{probe} , by changing the angle between the ingoing and outgoing waves (that is, the scattering angle) or by increasing or decreasing the wavelength of the neutrons used. To obtain information about structures by coherent elastic scattering, λ_{probe} must be chosen to be approximately the same as the size of the structure. For crystallography this means that λ_{probe} needs to be of the same order as interatomic spacings. We already know this from Bragg's law. A little trigonometry applied to Fig. 13 will show that $\lambda_{\text{probe}} = \lambda_{\text{neutron}} / 2 \sin \theta$, so that when λ_{probe} equals the distance between two adjacent scattering planes, Bragg's law is satisfied.

The probe-wave idea shows us how we can measure structures that are larger than typical interatomic distances. We

THE PROBE-WAVE VIEW OF NEUTRON SCATTERING

Fig. 13. Another way to view neutron scattering is to imagine that the incident neutron wave (In) and the scattered neutron wave (Out) form a secondary “probe wave” (here seen as a moiré pattern in both examples) that must match the average periodicity of the structure in the scattering sample. Because the average periodicity of the top sample is larger than that of the lower one, the wavelength of the probe wave, λ_{probe} , must also be larger, which in turn means that the scattering angle, 2θ , must be smaller (here 3°). Another way to vary λ_{probe} is to change the wavelength of the neutron, λ_{neutron} .

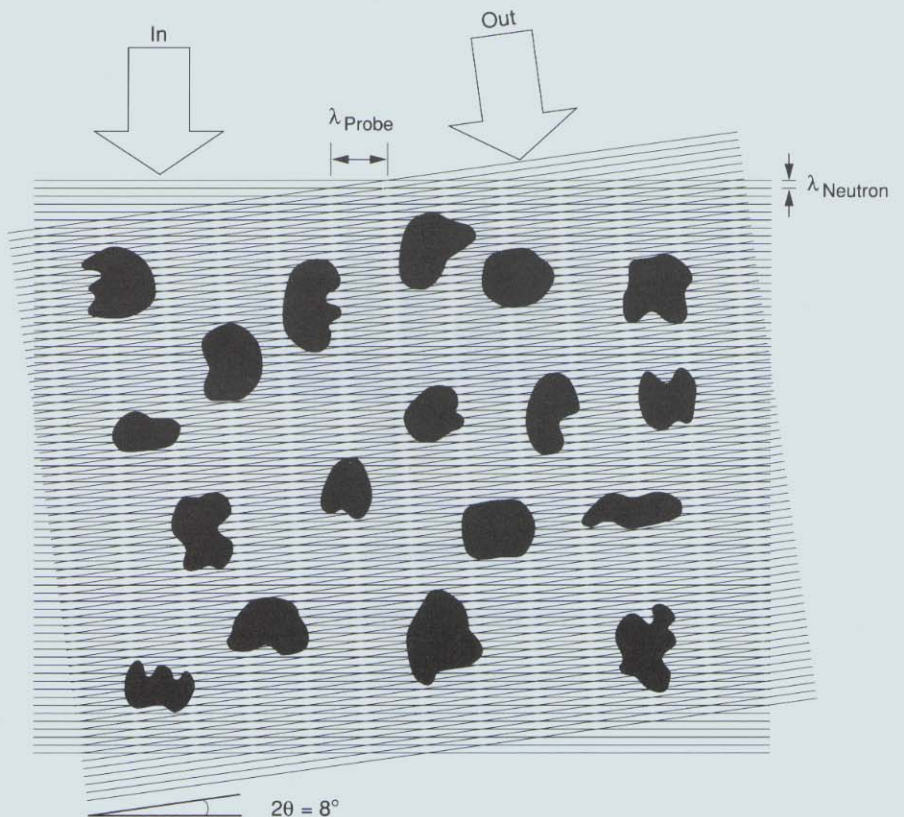
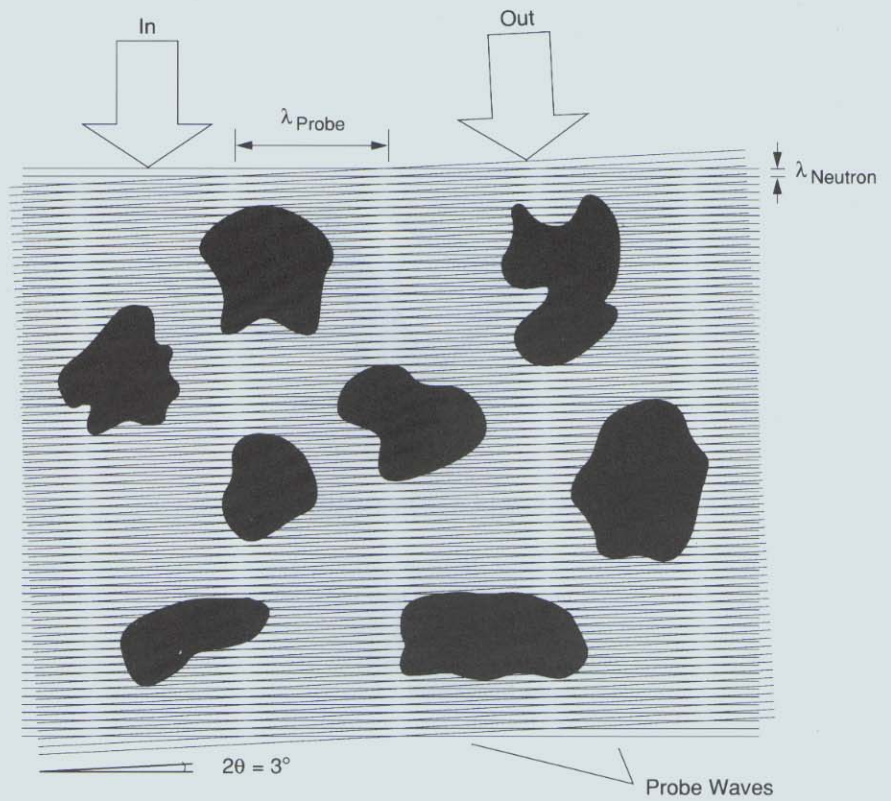

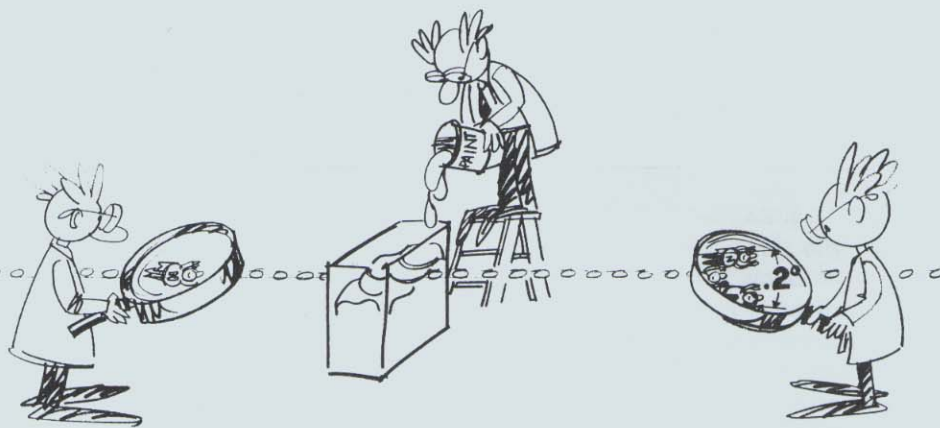

small-angle neutron scattering

A technique for studying structural details with dimensions between 10 and 1000 angstroms by measuring the intensity of neutrons scattered through small angles, usually less than 1 degree.

simply arrange for λ_{probe} to be large, either by decreasing the scattering angle or by increasing the neutron wavelength. In practice, to examine some of the larger structures displayed in Fig. 3—polymers, colloids, or viruses, for example—we need to use neutron wavelengths greater than 5 angstroms and scattering angles less than 1 degree. Because of the latter constraint, this technique is known as *small-angle neutron scattering*, or SANS.

The Van Hove formulation for neutron scattering may be manipulated (see “The Mathematical Foundations of Neutron Scattering”) to provide the following equation for the intensity of neutrons scattered at small angles (that is, for small values of Q):

$$I(\mathbf{Q}) = \left| \int b(\mathbf{r}) e^{i\mathbf{Q}\cdot\mathbf{r}} d^3r \right|^2, \quad (4)$$

where the integral extends over the entire scattering sample and $b(\mathbf{r})$, the *scattering-length density*, is calculated by summing the coherent scattering lengths of all the atoms over a small volume and dividing by that volume.

In many cases, samples measured by SANS consist of particles with a uniform scattering-length density b_p that are dispersed in a uniform matrix with a scattering-length density b_m . Examples include pores in rock, colloidal dispersions, biological macromolecules in

water, and many more. The integral in Eq. 4 can, in this case, be separated into a uniform integral over the whole sample and a term that depends on the difference, $b_p - b_m$, between the scattering length of the particles and that of the matrix. This difference is called the *contrast factor*. If all the particles are identical and their positions are uncorrelated, Eq. 4 becomes

$$I(\mathbf{Q}) = (b_p - b_m)^2 N_p \left| \int_{V_p} e^{i\mathbf{Q}\cdot\mathbf{r}} d^3r \right|^2, \quad (5)$$

where the integral is now over the volume V_p of one of the particles and N_p is the number of such particles in the sample.

The integral above of the phase factor $e^{i\mathbf{Q}\cdot\mathbf{r}}$ over a particle is called the *form factor* for that particle. For many simple particle shapes, the form factor can be evaluated without difficulty: the expression for spherical objects was first derived by Lord Rayleigh in 1911.

Equation 5 allows us to understand an important technique used in small-angle scattering known as *contrast matching*. The total scattering is proportional to the square of the scattering contrast between a particle and the matrix in which it is embedded. If we embed the particle in a medium whose scattering length is equal to that of the particle,

contrast matching

An isotopic-labeling technique based on the dramatic difference between the scattering lengths of hydrogen and deuterium, which is particularly useful in neutron-scattering studies of complex biological molecules in aqueous solution. The technique involves matching the scattering from the solvent with that from one component of the biological molecules by replacing the hydrogen atoms in the solvent or the component or both with deuterium. The observed scattering is then due to only the unmatched components.

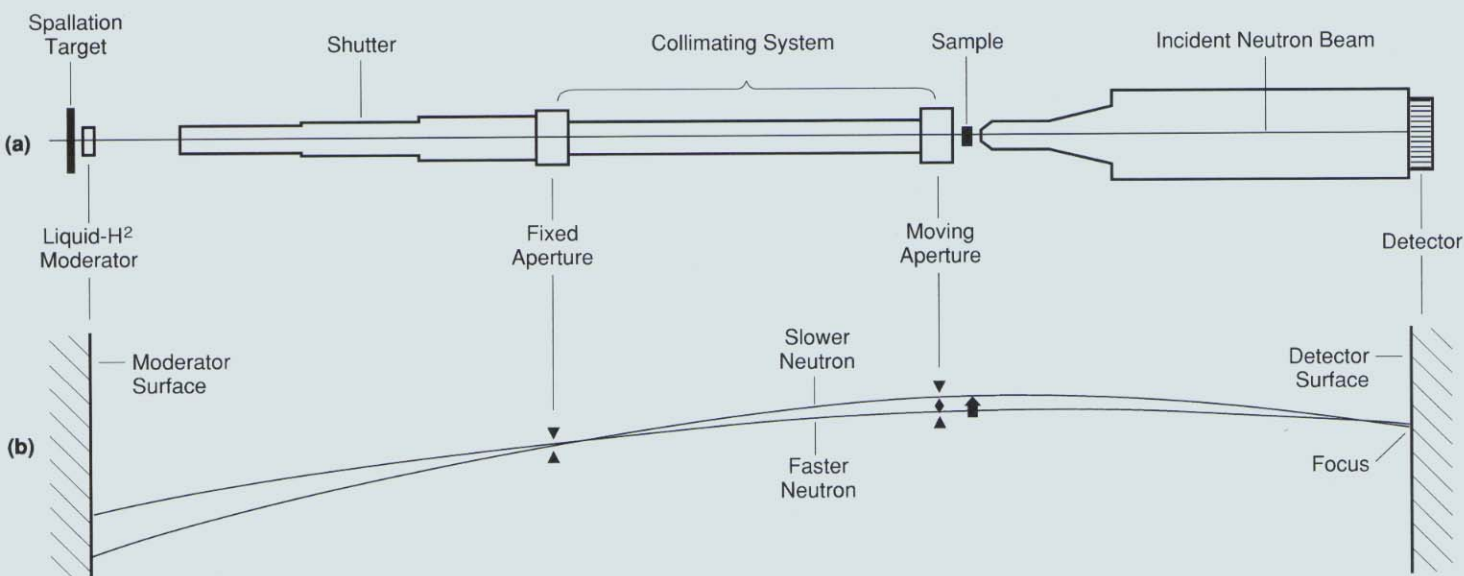

A SMALL-ANGLE NEUTRON-SCATTERING SPECTROMETER

Fig. 14. (a) The spectrometer illustrated here, the Low-Q Diffractometer (LQD) at LANSCE, measures neutron scattering at small angles. The neutrons are first moderated in liquid hydrogen to increase the percentage of very cool, long-wavelength neutrons in the beam that hits the sample. The moderated beam then passes through a collimating system that is more than 7 meters long before impinging on the sample. To increase the accuracy with which the small scattering angles can be measured, the large position-sensitive detector is placed far from the sample (about 4 meters). (b) Neutrons from a spallation source have a range of speeds and are thus under the influence of gravity for different amounts of time, an effect that smears the signal at the detector. However, the beam can be "focused" by placing a fixed aperture at the beginning of the collimator and a moveable aperture at the end of the collimator and accelerating the latter aperture upward during the pulse of neutrons. Such an arrangement selects only those neutrons with parabolic trajectories that end at the center, or focus, of the detector. Small-angle scattering is suitable for studying structures with dimensions in the range of 10 to 1000 angstroms.

the latter will be invisible. (This technique is used by the manufacturers of gel toothpaste—there really is gritty material in there to clean your teeth, but you can't see it because the grit and the gel have similar refractive indices!)

Suppose the particles we are interested in are spherical eggs rather than uniform spheres: they have a core (the yolk) with one scattering length and a covering (the white) of a different scattering length. If such particles are immersed in a medium whose scattering length is equal to that of the egg white, then a neutron-scattering experiment will only "see" the yolk. The form factor will be evaluated by integrating over this central region only. On the other hand, if our particles are suspended in a medium whose scattering length is the same as that of the yolk, only the egg white will be visible; the form factor will correspond to that of a thick, hollow shell. The scattering pattern will be different in the two cases, and from two experiments, we will discover the structures of both the covering and the core of the particle.

Variation of the scattering-length density of the matrix is often achieved by choosing a matrix that contains hydrogen (such as water). By replac-

ing different fractions of the hydrogen atoms with deuterium atoms, a large range of scattering-length densities can be achieved for the matrix. This contrast-matching technique works, as we pointed out earlier, because of the significantly different scattering-length densities of hydrogen and deuterium, and it is one of the main reasons for the successful application of neutron scattering to problems in biology. Both DNA and protein can be contrast matched by water containing different fractions of deuterium. Several problems in structural biology that have been studied by contrast matching are described in "Biology on the Scale of Neglected Dimensions" by Jill Trewhella.

Small-angle scattering is perhaps the easiest neutron-scattering technique to realize in practice. Like diffraction experiments, SANS experiments at a reactor source require a monochromator, whereas at a spallation source measurement of times of flight determine the wavelengths of the incident and scattered neutrons.

The Low-Q Diffractometer at the LANSCE facility (Fig. 14a) is an example of a SANS spectrometer at a spallation source. One essential component of the instrument is a large position-

sensitive neutron detector located behind the sample directly in line with the incident beam. Another important component (invented by Phil Seeger at LAN-SCE) is the gravity focuser (Fig. 14b), which accounts for the fact that neutrons fall under the influence of gravity. If the aperture at the exit of the collimator that defines the trajectory of the incident neutron beam was fixed, neutrons of different velocities could only pass through that slit if they were following parabolic paths that fell on the detector at different heights, blurring the image produced there. To avoid this blurring, the exit aperture of the collimator is moved upward during each neutron pulse. Slower neutrons then have to go through an opening that is higher relative to the center of the detector. The position of the aperture at each instant is chosen so that all neutrons, independent of their speed, arrive at the center of the detector, if they are not scattered by the sample. The whole thing is a little like a stone-throwing contest: weak throwers have to throw stones on a higher trajectory to hit the target.

Inelastic Scattering

In reality, atoms are not frozen in fixed positions in a crystal. Thermal energy causes them to oscillate about their lattice sites and to move around inside a small volume with the lattice site at its center. Since an atom can fully contribute to the constructive interference of Bragg scattering only when it is located *exactly* at its official position in the lattice, this scattering becomes weaker the more the atoms vibrate and the less time they spend at their official positions.

When a crystal structure is determined from single-crystal or powder diffraction, the extent of the thermal motion of the atoms is found at the same time as the atomic positions. Often, the thermal motions are anisotropic, indicating that it is easier for an atom to move

in particular directions away from its equilibrium position. Sometimes this information can be related to other properties, such as structural changes that occur at a phase transition or elastic anisotropy.

Although such weakening of the scattering signal is the only effect of the thermal motion of atoms on *elastic* Bragg scattering, it is not the only way to use neutrons to observe atomic motion. In fact, one of the great advantages of neutrons as a probe of condensed matter is that they can be used to measure the details of atomic and molecular motions by measuring *inelastic* scattering. In other words, when the neutron bounces off a molecular framework that is *not* totally rigid, we can have an inelastic interaction with an exchange of energy between neutrons and the lattice.

To explain this, we begin with another simple analogy. If one end of a rope is tied to a fixed point and the other end is jerked up and down, a wave can be observed traveling along the rope. A discontinuous version of this effect can be obtained with a chorus line (for this analogy I am indebted to a colleague who once choreographed it for a midwestern television station). If each member of the line swings a leg but starts the swing slightly after his or her nearest neighbor to one side, the net effect is the appearance of a wave traveling along the line. The thermal motion of atoms in a crystal can be described in terms of a superposition of waves of this sort. One may imagine the atoms to be the feet of the members of the chorus line.

The analogy, if not the image, can be improved by replacing the swinging legs with rigid pendulums with weights at their extremities. Rather than watching for a neighbor to swing a leg, we achieve coupling by attaching identical springs between each pendulum and its two nearest neighbors. Now, if we dis-

place one pendulum, the springs tend to cause the neighboring pendulums to move as well, and a wave starts passing up and down the line, just as it did for the chorus. The frequency of motion depends on the mass of the pendulums and the stiffness of the springs that connect them.

Waves similar to those in the chain of pendulums pass through a lattice of atoms connected by the binding forces that are responsible for the cohesion of matter. The whole effect is much more difficult to visualize in this case, however, because it happens in three dimensions. Nevertheless, it is possible to prove that any atomic motion in a crystal can be described by a superposition of waves of different frequencies and wavelengths traveling in different directions. In other words, the thermal motion of the atoms about their lattice sites can be described as a superposition of waves moving through the lattice, and these waves are known as *phonons*. Their energies are quantized so that each phonon has an energy $h\nu$, where ν is the frequency of atomic motion associated with that phonon. Just as in the pendulum analogy, the frequency of a phonon depends on the wavelength of the distortion, the masses of the atoms, and the stiffness of the “springs,” or binding forces, that connect them.

When a neutron is scattered by a crystalline solid, it can absorb or emit an amount of energy equal to a quantum of phonon energy, $h\nu$. This gives rise to inelastic coherent scattering of neutrons in which the neutron energy before and after the scattering event differ by an amount ϵ equal to the phonon energy. In most solids ν is a few times 10^{12} hertz, and the corresponding phonon energy is a few meV (10^{12} hertz corresponds to an energy of 4.18 meV). Because the thermal neutrons used for scattering experiments also have energies in the meV range, scattering by a phonon causes an appreciable fractional

phonons

Fundamental vibrational waves in a crystal in which nuclei oscillate in a coordinated manner about their "official" positions.



change in the neutron energy. This allows an accurate measurement of the energy change and makes neutrons an ideal tool for measuring phonon frequencies and hence for obtaining information about the forces that hold matter together.

For inelastic scattering—from phonons, for example—a neutron has different velocities, and thus different wave vectors, before and after it interacts with the sample; so the corresponding sides of the scattering triangle (\mathbf{k} and \mathbf{k}' in Fig. 5b) are of unequal lengths. To determine the phonon energy and the scattering vector, \mathbf{Q} , we need to determine the neutron wave vector before and after the scattering event. At a reactor we may resort to the method already discussed—Bragg scattering from single crystals. A first crystal, the monochromator, directs neutrons of a given energy at the sample (as was done for the powder diffractometer shown in Fig. 9). After the sample scatters these neutrons in various directions, a second crystal—positioned at a well-defined scattering angle and called the *analyzer*—Bragg reflects only those neutrons that have a particular energy into a suitably placed detector. This type of instrument is called a *three-axis spectrometer* (Fig. 15) because there are three centers (monochromator, sample, and analyzer) at which the scattering angles can be altered. Such instruments are the workhorses for the measurement of phonons at reactors.

Three-axis spectrometers have contributed prolifically to the various scientific problems studied by neutron scattering, probably because they are so *inefficient*. At each setting of the

spectrometer—corresponding to particular scattering angles at the monochromator, sample, and analyzer—a measurement is made for a single scattering vector, \mathbf{Q} , and energy transfer, ϵ . Each measurement usually takes several minutes; a complete scan at a series of values of ϵ may take hours or even days. This inefficiency has advantages, though—it allows the experimenter to concentrate on measuring particular excitations at particular values of \mathbf{Q} and ϵ , and it gives that person time to plan each new measurement in light of the data already accumulated.

The success of three-axis spectrometers leads to an interesting philosophical dilemma. Does materials science by its very nature require for its study an instrument such as a three-axis spectrometer? That is, is there some reason to believe that a majority of interesting and important effects occur, like Bragg scattering, only in a restricted range of values of \mathbf{Q} and ϵ ? Or has our understanding of materials actually been hampered because three-axis spectrometers have been so popular and prolific? Have we seen only a part of the truth because three-axis spectrometers can only probe a single scattering vector and energy transfer at one time? Would we learn more if we could make measurements for a wide range of values of \mathbf{Q} and ϵ simultaneously? Of course only the extensive use of alternative types of spectrometers can answer this question. Many of the instruments that are best suited to surveys of neutron scattering for large ranges of scattering vector and energy transfer are located at spallation sources such as the one at LANSCE.

There is no real equivalent of the

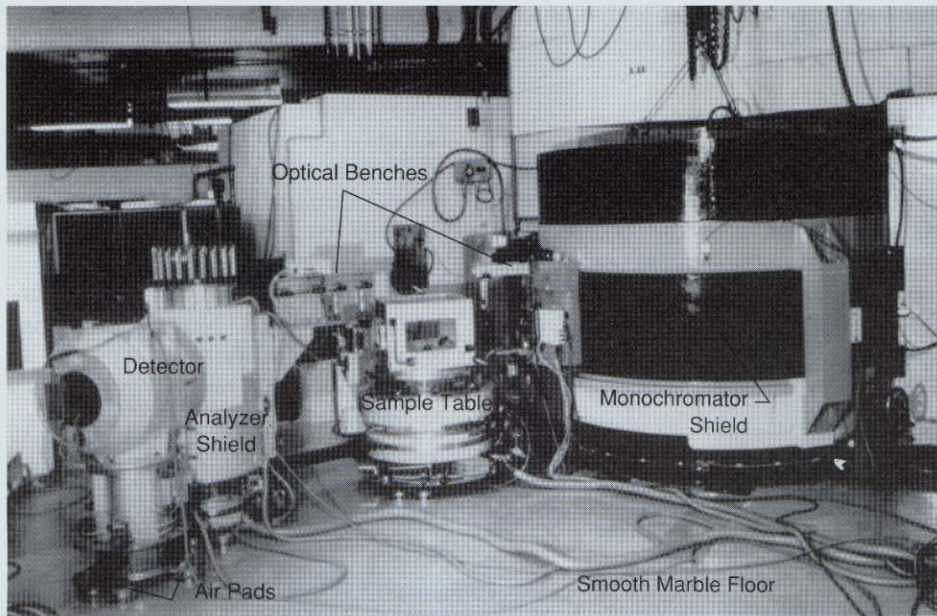

THREE-AXIS NEUTRON SPECTROMETER

Fig. 15. A three-axis spectrometer built by the author at the Institut Laue Langevin in Grenoble, France. The scattering angles at the monochromator, sample, and analyzer can be varied by moving these connected units on the air pads seen in the photograph. This spectrometer is equipped for polarization analysis. The hollow box-like object on the sample table has current-carrying wires along each edge that can produce a field of about 100 oersteds at any direction on a sample placed at the center of the box. Various spin flippers, diaphragms, and filters are mounted on the optical benches before and after the sample position.

three-axis spectrometer that can be built at a spallation source. Inelastic scattering can, however, be measured in a variety of ways. Perhaps the simplest is to place an analyzing crystal in the scattered neutron beam just as one does with the three-axis machine. This crystal determines the final energy of the neutrons scattered by the sample. Once this energy and the total time of flight from the moderator to the detector are known, the incident energy can also be deduced.

Another method of measuring inelastic scattering at a pulsed spallation source has been used to obtain some of the data discussed by Juergen Eckert and Phil Vergamini (see "Neutrons and Catalysis"). This method uses a filter rather than an analyzing crystal in the scattered neutron beam. The filter allows only neutrons whose energy is less than a certain cutoff value to pass through to a detector behind the filter. Filters of this type can be made, for example, from a block of cooled polycrystalline beryllium that is several centimeters thick. When neutrons impinge on the block, they are scattered just as

they would be from any polycrystalline material. But there is a maximum value of the neutron wavelength beyond which Bragg scattering cannot occur because there are no atomic planes spaced far enough apart to diffract these long-wavelength neutrons. Neutrons with wavelengths greater than the cut-off therefore pass through the filter without being scattered out of the beam. In the case of beryllium, neutrons with wavelengths greater than about 4 angstroms (energies less than about 5 meV) are transmitted. In the Filter-Difference Spectrometer at LANSCE, two filters are used, beryllium and beryllium oxide. The latter material transmits neutrons with energies below 3.7 meV. By subtracting data obtained with the BeO filter from that obtained with the Be filter, we obtain a result that includes only those neutrons with final energies in the narrow window between 3.7 meV and 5 meV, the two filtering energies. This technique allows the energy of the scattered neutrons to be determined accurately. As usual, the total time of flight lets us deduce the incident energy of the neutrons.

The Filter Difference Spectrometer is not well suited for measurements of phonons because the geometry of the instrument makes it inherently difficult to determine the scattering vector, Q , to a high degree of accuracy. This is an advantage when one is measuring incoherent inelastic scattering, however, because the energy transfer ϵ is often independent of Q , and one may sum scattered intensities for many values of Q , thereby increasing the statistical accuracy of the data obtained. This summation is accomplished automatically with the Filter Difference Spectrometer at LANSCE.

The final method of measuring inelastic scattering at a spallation source—a method that *does* determine the scattering vector accurately—makes use of a so-called chopper spectrometer. The chopper, which can be thought of as a short (20-centimeter) pipe rotating about an axis perpendicular to its length, is placed in the neutron beam ahead of the scattering sample. If the pipe is rotating at a frequency that is an integral multiple of that of the pulsed neutron source, it briefly becomes aligned with

the neutron beam at the same time during each neutron pulse from the moderator. Because the chopper is usually several meters from the neutron moderator, the fast neutrons in each pulse arrive at the chopper ahead of their slower brethren. Only those neutrons that arrive at the chopper when it is open—that is, aligned with the beam—get through. Thus, the chopper selects neutrons in a small band of velocities and allows them to impinge on the sample. Neutrons outside this band will arrive either too late or too early at the chopper and will be stopped. The chopper thus determines the wave vector of the neutrons incident on the sample, whereas a measurement of the total time of flight allows the wave vector of the scattered neutrons to be calculated as well.

A great advantage of chopper spectrometers is that neutron detectors can be placed at many different scattering angles simultaneously, allowing scattering to be recorded at many values of Q and ϵ . The disadvantage is that the experimenter is inundated with data and must rely heavily on computers to reduce the massive array of numbers to something comprehensible.

In fact, massive amounts of data are the norm for spectrometers at spallation sources. At each detector, a series of Q and ϵ values are measured that correspond to a full range of differing flight times of the detected neutrons. One automatically obtains these values whether one wants the flood of data or not. In short, a three-axis spectrometer at a reactor source is a rifle, whereas its equivalent at a spallation source is a shotgun. Which source is more efficient for a given experiment really depends on what type of information one wants—a single bull's-eye or a barn door full of interesting holes! More seriously, we can obtain a detailed knowledge of the scattering law for a few values of Q and ϵ at a reactor source and a more

extended picture covering a wide range of these variables at a spallation source.

Magnetic Scattering

So far we have discussed only the interaction between neutrons and atomic nuclei. But there is another interaction between neutrons and matter—one that results from the fact that a neutron has a magnetic moment (Fig. 2). Just as two bar magnets either attract or repel one another, the neutron experiences a force of magnetic origin whenever it passes close to another magnetic particle, such as an electron in matter.

Most electrons in atoms or in matter are paired so that the magnetic moment of one electron cancels that of its partner. Occasionally, however, not all the outer, or binding, electrons are paired in a particular compound, and neutrons are scattered by the resulting magnetic moments. Diffraction experiments, similar to those described earlier, can be used to measure the density of such unpaired electrons between the atoms of a solid.

Ferromagnetic materials, such as iron, are magnetic because the moments of their unpaired electrons tend to align spontaneously. For many purposes, such materials behave as if a small magnetic moment were located at each atomic site with all the moments pointed in the same direction. These moments give rise to Bragg diffraction of neutrons in the same manner as the nuclear interaction. Because nuclear and magnetic interactions experienced by the neutron are of similar magnitude, the corresponding Bragg reflections are also of comparable intensity.

One difference between the two types of scattering, however, is that magnetic scattering, unlike its nuclear counterpart, is not isotropic. The magnetic interaction has a dipolar nature, which can easily be observed by bringing two bar magnets close to one another. Suppose the two magnets are parallel with

their north poles pointing upward. If one magnet is above the other, unlike poles will be close, and the magnets will attract; if they are side by side, like poles will be close, and the magnets will repel. For neutrons, the dipolar nature of magnetic interaction means that only the component of the sample's magnetization that is perpendicular to the scattering vector, Q , is effective in scattering neutrons. Neutron scattering is therefore sensitive to the direction of magnetization in a material as well as to its spatial distribution.

The anisotropic nature of the magnetic interaction can be used to separate nuclear and magnetic Bragg peaks in ferromagnets, for which both types of Bragg peaks occur at the same values of Q . If the electronic moments can be aligned by an applied magnetic field, magnetic Bragg peaks for which Q is parallel to the induced magnetization vanish, leaving only the nuclear component. On the other hand, an equivalent Bragg peak for which the scattering vector is perpendicular to the field will manifest both nuclear and magnetic contributions.

In an antiferromagnet (a material with unpaired electrons that have an *alternating*, or antiparallel, arrangement), the repeat distance between planes of magnetic moments is twice that of the spacing between corresponding planes of atoms. As a result, Bragg's law is satisfied at scattering angles whose sines are half those for normal Bragg scattering, as well as at the normal angles. Half the magnetic Bragg peaks fall between their nuclear counterparts, and the problem of separating magnetic and nuclear contributions does not arise. Nevertheless, the dipolar character of the magnetic interaction again allows the electronic spin directions to be established. A recent example of this is to be found in the superconducting cuprates—the so-called high-temperature superconductors—some of which are an-

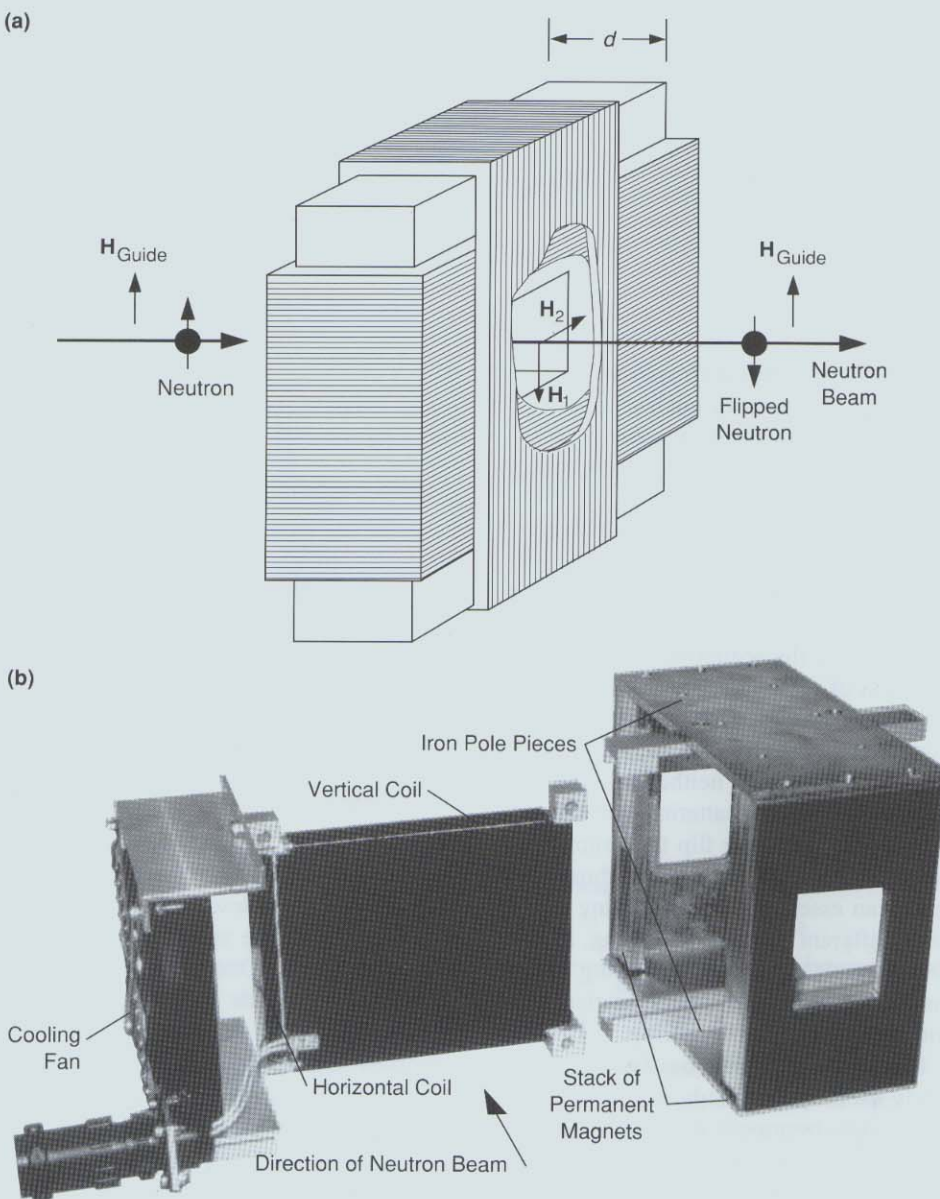

suitable magnetized crystals, reflection from magnetized mirrors made of cobalt and iron (CoFe), and transmission through polarized helium-3, for example. Each of these methods aligns the neutron moments parallel or antiparallel to an applied magnetic field. If the neutron moments are parallel to the field, they are said to be *up*; if the moments are antiparallel, they are said to be *down*. An *'up'* polarizer will not transmit *'down'* neutrons, just as a *'down'* polarizer blocks *'up'* neutrons. Thus, by placing an *'up'* polarizer before and after a scattering sample, the neutron scattering law can be measured for those scattering processes in which the direction of the neutron moment is not changed. To measure the other combinations—such as *'up'* neutrons being flipped to *'down'* neutrons—requires either a variety of different *'up'* and *'down'* polarizers or a device called a *flipper*. Because polarizers tend to be expensive, flippers are the practical choice.

A flipper is a device that can change the direction of a neutron moment from up to down or vice versa. This can be done in one of two ways. Either the direct current in the horizontal coil of aluminum wires produces a field H_1 inside the device that is equal but opposite to the neutron guide field H_{guide} , effectively canceling that component. The vertical coil produces a field H_2 that is at right angles to the guide field and thus to the moment of the neutron, causing it to precess. The strength of this field and the thickness d of the flipper are chosen so that the neutron precesses exactly 180 degrees during its passage. In either case, the direction of the neutron moment with respect to the field (which is all that counts) has been changed.

An example of the second type of flipper is shown in Fig. 16. It consists of two flat coils of wire wrapped one on top of the other. One of the coils produces a field inside the flipper that is equal and opposite to the guide field, effectively canceling that component, and the other coil produces a field perpendicular to the guide field. Thus, when a neutron enters the flipper, it suddenly experiences a magnetic field that is at right angles to the direction of its mag-

A FLAT-COIL NEUTRON-SPIN FLIPPER

Fig. 16. (a) Schematic diagram of one type of neutron flipper. A direct current in the horizontal coil of aluminum wires produces a field H_1 inside the device that is equal but opposite to the neutron guide field H_{guide} , effectively canceling that component. The vertical coil produces a field H_2 that is at right angles to the guide field and thus to the moment of the neutron, causing it to precess. The strength of this field and the thickness d of the flipper are chosen so that the neutron precesses exactly 180 degrees during its passage. (b) Photograph of disassembled neutron flipper. The penetrating power of neutrons is apparent in the fact that there is no "window" in the two coils of wire; the neutrons pass on through the aluminum wire unimpeded. The component on the right produces a vertical guide field of about 40 oersteds.

tiferromagnetic when oxygen deficient.

Polarized Neutrons. Usually, a neutron beam contains neutrons with magnetic moments pointing in all directions. If we could measure the number of neutrons with moments parallel and antiparallel to a particular direction—say an applied magnetic field—we would find equal populations. However, various

special techniques can generate a *polarized* beam, that is, one with a large fraction of its neutron moments in the same direction. The polarization of such a beam can be maintained by applying a modest magnetic field (a few tens of oersteds) all along the beam. Such a field is called the *guide field*.

There are several ways to polarize neutron beams: Bragg diffraction from

netic moment. In this situation the classical equations that describe the motion of the neutron moment are similar to those of a rotating top that has been pushed by a force from the side and so begins precessing about its original axis of rotation. The neutron does the same thing—its moment starts to precess about the local field direction at a rate known as the *Larmor frequency*, which depends on the magnitude of the field inside the flipper. By choosing the thickness of the flipper and the strength of the field in the second coil appropriately, one can arrange for the neutron moment to rotate precisely 180 degrees during its passage through the flipper. Clearly, if a neutron's moment was up before the flipper, it will be down after the flipper, and vice versa.

Now suppose we have a spectrometer with polarizers before and after the scattering sample. If flippers are inserted on either side of the sample, we can measure all of the neutron scattering laws—up to down, up to up, and so forth—simply by turning the appropriate flipper on or off. This technique, known as *polarization analysis*, is useful because some scattering processes flip the neutron's moment whereas others do not.

Scattering from a sample that is magnetized provides a good example. Magnetic scattering will flip the neutron's moment if the magnetization responsible for the scattering is perpendicular to the guide field used to maintain the neutron polarization. If the magnetization is parallel to the guide field, no flipping occurs. Thus, like the dipolar interaction described earlier, polarization analysis is a technique that helps determine the direction of electronic moments in matter.

Incoherent scattering that arises from the random distribution of nuclear spin states in materials provides another example of the use of polarization analysis. Most isotopes have several spin states, and the scattering cross section

for a nucleus varies with spin state. The random distribution of nuclear spins in the sample gives rise to incoherent scattering of neutrons. It turns out that two-thirds of the neutrons scattered by this incoherent process have their moments flipped, whereas the moments of the remaining third are unaffected. This result is independent of the isotope that is responsible for the scattering and of the direction of the guide field. Although incoherent scattering can also arise if a sample contains a mixture of isotopes of a particular element, neither this second type of incoherent scattering nor coherent nuclear scattering flip the neutron's moment. Polarization analysis thus becomes an essential tool for sorting out these different types of scattering, allowing nuclear coherent scattering to be distinguished from magnetic scattering and spin-incoherent scattering.

Polarization analysis has been particularly useful in the study of magnetic phenomena because it has helped to determine the directions of the magnetic fluctuations responsible for scattering. Without this technique, many of the elegant experiments that have provided confirmation for ideas about nonlinear physics (see "Nonlinear Science—From Paradigms to Practicalities" by David K. Campbell, *Los Alamos Science* No. 15, 1987) could not have been performed. The three-axis spectrometer of Fig. 15, for example, is equipped for polarization analysis.

Magnons. Another important aspect of magnetized materials is the fact that the directions of the atomic moments in a material such as iron can oscillate like the pendulums considered earlier for lattice vibrations. Here again, there is a coupling between magnetization at different atomic sites, and a wave of magnetic oscillations can pass through the material. These magnetic excitations, or *magnons*, are the magnetic analogue of the phonon displacement

waves described earlier. Not surprisingly, magnon frequencies can be measured by inelastic neutron scattering in the same way as phonon frequencies. Since the magnetic oscillations that make up the magnons are perpendicular to the equilibrium direction of the atomic moments, the scattering causes the magnetic moment of the neutrons to be flipped, provided the neutron guide field is parallel to the equilibrium direction of the atomic moments. This, of course, allows one to distinguish between phonons and magnons.

Surface Structure

So far we have described only experiments in which the structure of bulk matter is probed. One may ask whether neutrons can provide any information about the structure of the surfaces of materials. At first sight, one might expect the answer to be a resounding "No!" After all, one of the advantages of neutrons is that they can penetrate deeply into matter without being affected by the surface. Furthermore, because neutrons interact only weakly with matter, large samples are generally required. Because there are far fewer atoms on the surface of a sample than in its interior, it seems unreasonable to expect neutron scattering to be sensitive to surface structure.

In spite of these objections, it turns out that neutrons *are* sensitive to surface structure when they impinge on the surface at sufficiently low angles. In fact, for smooth surfaces, perfect reflection of neutrons occurs for almost all materials at angles of incidence (the angle between the incident beam and the surface) less than a *critical angle*, denoted γ_c . This angle is proportional to the coherent scattering-length density of the material and the neutron wavelength. For a good reflector, such as nickel, the critical angle measured in degrees is about one-tenth of the neutron

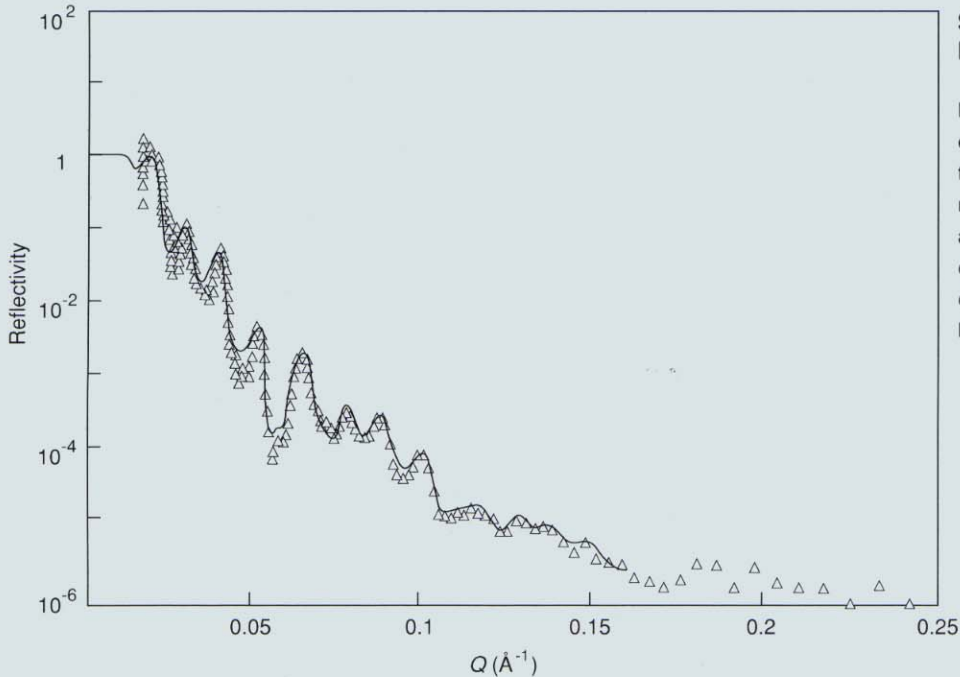

SURFACE REFLECTIVITY MEASUREMENTS

Fig. 17. Neutron reflectivity as a function of Q ($= 4\pi \sin \theta / \lambda$) for a 1500-angstrom thick diblock copolymer (polystyrene-poly-methylmethacrylate) multilayer deposited on a silicon substrate. The solid line represents calculated reflectivity for the data shown. The calculation was performed by Tom Russell, IBM Almaden Research Labs.

wavelength measured in angstroms—it is well under a degree for thermal neutrons. As the angle of incidence increases above the critical angle, less and less of the incident neutrons are reflected by the surface. In fact, reflectivity, which measures the fraction of neutrons reflected from the surface, obeys the same law, discovered by Fresnel, that applies to the reflection of light: reflectivity decreases as the fourth power of the angle of incidence at sufficiently large grazing angles.

However, Fresnel's law applies to reflection of radiation from the smooth, flat surface of a homogeneous material. If the material is inhomogeneous and there is a variation of the scattering-length density perpendicular to the surface, the neutron reflectivity, measured as a function of the angle of incidence, shows a more complicated behavior. By keeping the reflection angle, θ , small, neutron reflectometry can be used to probe density variations in the surface to depths of a few thousand angstroms with a resolution of a few angstroms.

Most of today's technical gadgets

are either painted or coated in some fashion to prevent corrosion or wear. Reflectometry can often provide useful information about such protective layers. Figure 17, for example, shows the reflectivity, measured on the LANSCE Surface Profile Analysis Reflectometer (SPEAR), from a 1500-angstrom layer of diblock copolymer (polystyrene-polymethylmethacrylate) multilayer deposited on a silicon substrate. The spacing of the undulations in this result provides a direct measure of the average thickness of the polymer layers in the film. When the detailed shape of the reflectivity profile is compared with theoretical predictions, the density and thickness of the polymer layers, as well as the thickness of the interface between layers, can be deduced.

Neutron reflectometry is a relatively new technique. It is also one ideally suited to spallation sources. In the next few years I expect the method to provide new information on subjects as diverse as the recycling of polymers, magnetic recording media, and the cleanup of oil spills. For someone like me who

has been associated with neutron scattering for more than twenty years, the birth of this new technique is a happy event. It means that there are still qualitatively new ways in which neutrons can help unravel the complex structures of the materials on which we depend. ■

The Mathematical Foundations of Neutron Scattering

In 1954 Van Hove derived a general expression for the intensity, $I(\mathbf{Q}, \epsilon)$, of neutrons scattered by any assembly of nuclei. His result makes use of Fermi's observation that the actual interaction between a neutron and a nucleus may be replaced by an effective potential that is much weaker than the actual interaction. This *pseudo*-potential causes the same scattering as the actual interaction but is weak enough to be used in the perturbation expansion derived by Max Born. The Born approximation says that the probability of an incident plane wave of wave vector \mathbf{k} being scattered by a weak potential $V(\mathbf{r})$ to become an outgoing plane wave with wave vector \mathbf{k}' is proportional to

$$\left| \int e^{i\mathbf{k}'\cdot\mathbf{r}} V(\mathbf{r}) e^{-i\mathbf{k}\cdot\mathbf{r}} d^3r \right|^2 = \left| \int e^{i\mathbf{Q}\cdot\mathbf{r}} V(\mathbf{r}) d^3r \right|^2, \quad (1)$$

where the integration is over the volume of the scattering sample. (We should note that even though individual nuclei scatter spherically, $V(\mathbf{r})$ represents the potential due to the entire sample, and the resulting disturbance for the assembly of atoms is a plane wave.)

The potential to be used in Eq. 1 is Fermi's pseudo-potential, which, for a single nucleus, is given by $b_j \delta(\mathbf{r} - \mathbf{r}_j)$, where b_j is the scattering length of a nucleus labeled j located at position \mathbf{r}_j and δ is a Dirac delta function that is zero unless the position vector \mathbf{r} coincides with \mathbf{r}_j . Thus, for an assembly of nuclei, such as a crystal, the potential $V(\mathbf{r})$ is the sum of individual neutron-nuclei interactions:

$$V(\mathbf{r}) = \sum_j b_j \delta(\mathbf{r} - \mathbf{r}_j), \quad (2)$$

where the summation is over all the nuclear sites in the crystal.

Using Eqs. 1 and 2, Van Hove was able to show that the scattering law—that is, the number of neutrons scattered per incident neutron—can be written as

$$I(\mathbf{Q}, \epsilon) = \frac{1}{h} \frac{k'}{k} \sum_{j,k} b_j b_k \int_{-\infty}^{\infty} \langle e^{-i\mathbf{Q}\cdot\mathbf{r}_k(0)} e^{i\mathbf{Q}\cdot\mathbf{r}_j(t)} \rangle e^{-i\epsilon t} dt. \quad (3)$$

Note that the sum here is over *pairs* of nuclei j and k and that the nucleus labeled j is at position $\mathbf{r}_j(t)$ at time t , whereas the nucleus labeled k is at position $\mathbf{r}_k(0)$ at time $t = 0$. The angular brackets $\langle \dots \rangle$ denote an average over all possible starting times for observations of the system, which is equivalent to an average over all the possible thermodynamic states of the sample.

The position vectors \mathbf{r}_j in Eq. 3 are quantum-mechanical operators that have to be manipulated carefully. Nevertheless, it is instructive to ignore this subtlety and treat the equation as if it described a system obeying classical mechanics because such an approach clarifies the physical meaning of the equation. The sum over atomic sites in Eq. 3 can then be rewritten as

$$\sum_{j,k} b_j b_k \langle e^{-i\mathbf{Q}\cdot[\mathbf{r}_k(0) - \mathbf{r}_j(t)]} \rangle = \sum_{j,k} b_j b_k \int_{-\infty}^{\infty} \delta(\langle \mathbf{r} - [\mathbf{r}_k(0) - \mathbf{r}_j(t)] \rangle) e^{-i\mathbf{Q}\cdot\mathbf{r}} d^3r, \quad (4)$$

in which the Dirac delta function appears again, this time in terms of \mathbf{r} and a difference vector between the position of nucleus j at time t and that of nucleus k at time zero.

Let us suppose for the moment that the scattering lengths of all the atoms in our sample are the same ($b_j = b_k = b$). In this case, the scattering lengths in Eq. 4 can be removed from the summation, and the right side becomes

$$Nb^2 \int_{-\infty}^{\infty} G(\mathbf{r}, t) e^{-i\mathbf{Q}\cdot\mathbf{r}} d^3r, \quad (5a)$$

where

$$G(\mathbf{r}, t) = \frac{1}{N} \sum_{j,k} \langle \delta(\mathbf{r} - [\mathbf{r}_k(0) - \mathbf{r}_j(t)]) \rangle \quad (5b)$$

and N is the number of atoms in the sample. The delta function in the definition of $G(\mathbf{r}, t)$ is zero except when the position of an atom k at time zero and the position of atom j at time t are separated by the vector \mathbf{r} . Because the delta functions are summed over all possible pairs of atoms to obtain $G(\mathbf{r}, t)$, this function is equal to the probability of an atom being at the origin of a coordinate system at time zero and an atom being at position \mathbf{r} at time t . $G(\mathbf{r}, t)$ is generally referred to as the *time-dependent pair-correlation function* because it describes how the correlation between two particles evolves with time.

Van Hove's neutron-scattering law (Eq. 3) can now be written as

$$I(\mathbf{Q}, \epsilon) = \frac{Nb^2}{h} \frac{k'}{k} \int_{-\infty}^{\infty} G(\mathbf{r}, t) e^{-i\mathbf{Q}\cdot\mathbf{r}} e^{-i\epsilon t} d^3r dt, \quad (6)$$

which allows us see that $I(\mathbf{Q}, \epsilon)$ is proportional to the space and time Fourier transforms of the time-dependent pair-correlation function. This general result gave a unified description for all neutron-scattering experiments and thus provided the framework for defining neutron scattering as a field.

As discussed in the text of the main article, this fact—that $I(\mathbf{Q}, \epsilon)$ is simply the Fourier transform of a function that gives the probability of finding two atoms a certain distance apart—is responsible for the power of neutron scattering. By inverting Eq. 6, information about both structure and dynamics of condensed matter may be obtained from the scattering law.

Coherent and Incoherent Scattering

Even for a sample made up of a single isotope, all of the scattering lengths that appear in Eq. 3 will not be equal. This is because the scattering length of a nucleus depends on its spin state, and most isotopes have several spin states. Generally, however, there is no correlation between the spin of a nucleus and its position in a sample of matter. For this reason, the scattering lengths that appear in Eq. 3 can be averaged over the nuclear spin states without affecting the thermodynamic average (denoted by the angular brackets).

Two spin averages come into play: the average value of b (\bar{b}) and the average value of b^2 ($\overline{b^2}$). In terms of these quantities, the sum in Eq. 3 can be averaged over the nuclear spins to give

$$\sum_{j,k} \overline{b_j b_k} A_{jk} = \sum_{j,k} (\bar{b})^2 A_{jk} + \sum_j (\overline{b^2} - (\bar{b})^2) A_{jj}, \quad (7)$$

where A_{jk} is shorthand for the integral in Eq. 3. The first term on the right side of Eq. 7 represents the so-called *coherent scattering*, whereas the second represents

the *incoherent scattering*. Thus, we can define the coherent and incoherent scattering lengths as

$$\begin{aligned} b_{\text{coh}} &= \bar{b} \quad \text{and} \\ b_{\text{inc}} &= \sqrt{\bar{b}^2 - (\bar{b})^2}. \end{aligned} \quad (8)$$

The expression for the coherent scattering law is a sum over both j and k and thus involves correlations between the position of an atom j at time zero and the position of a second atom k at time t . Although j and k are occasionally the same atom, in general they are not the same because the number N of nuclei in the sample is large. We can thus say that coherent scattering essentially describes interference between waves produced by the scattering of a single neutron from all the nuclei in a sample. The intensity for this type of scattering varies strongly with the scattering angle.

Incoherent scattering, on the other hand, involves correlations between the position of an atom j at time zero and the position of the *same* atom at time t . Thus, in incoherent scattering, the scattered waves from different nuclei do not interfere with each other. For this reason, incoherent scattering provides a good method of examining processes in which atoms diffuse. In most situations, the incoherent scattering intensity is isotropic; that is, it is the same for any scattering angle. This effect often allows incoherent scattering to be ignored when observing coherent scattering because the incoherent effects just add intensity to a structureless background.

The values of the coherent and incoherent scattering lengths for different elements and isotopes do not vary in any obviously systematic way throughout the periodic table. For example, hydrogen has a large incoherent scattering length (25.18 fermis) and a small coherent scattering length (−3.74 fermis). Deuterium, on the other hand, has a small incoherent scattering length (3.99 fermis) and a relatively large coherent scattering length (6.67 fermis). As mentioned in the main article, the difference between the coherent scattering lengths of hydrogen and deuterium is the basis of an isotopic-labeling technique, called *contrast matching*, that is especially important in applications of neutron scattering to structural biology and polymer science.

Diffraction

One of the important applications of Van Hove's equation (Eq. 3) is the scattering law for diffraction, which we develop here for a crystal containing a single isotope. Even though diffraction is predominantly an elastic scattering process ($\epsilon = 0$), neutron diffractometers actually integrate over the energies of scattered neutrons. Thus, rather than setting $\epsilon = 0$ in Eq. 3 to calculate the diffracted intensity, we integrate the equation over ϵ . This procedure ensures that the effect of atomic vibrations is included in the diffraction cross section. The integral of Eq. 3 over ϵ gives another Dirac delta function, $\delta(t)$, that tells us that the pair correlation function, $G(\mathbf{r}, t)$, has to be evaluated at $t = 0$ for diffraction. The result, for a crystal containing a single isotope, is

$$I(\mathbf{Q}) = b_{\text{coh}}^2 \sum_{j,k} \langle e^{i\mathbf{Q} \cdot (\mathbf{r}_j - \mathbf{r}_k)} \rangle, \quad (9)$$

where the atomic positions \mathbf{r}_j and \mathbf{r}_k are evaluated at the same instant.

If the atoms in a sample were truly stationary, the thermodynamic averaging brackets could be removed from Eq. 9 because \mathbf{r}_j and \mathbf{r}_k would be constant. In reality the atoms oscillate about their equilibrium positions and only spend a fraction of their time at these positions. When this is taken into account, the thermodynamic average introduces another factor, called the Debye-Waller factor, and Eq. 9 then becomes

$$I(\mathbf{Q}) = b_{\text{coh}}^2 \sum_{j,k} e^{i\mathbf{Q} \cdot (\mathbf{r}_j - \mathbf{r}_k)} e^{-\frac{1}{2}Q^2 \langle u^2 \rangle} \equiv S(\mathbf{Q}), \quad (10)$$

where $\langle u^2 \rangle$ is the average of the square of the displacement of an atom from its equilibrium position and diffracted intensity is now also called $S(\mathbf{Q})$, the structure factor. This equation is the basis of any crystallographic analysis of neutron-diffraction data.

Small-Angle Scattering.

An important simplification of Eq. 3 occurs when the scattering angle is small. This approximation leads to the formula for one of the most popular neutron-scattering techniques—SANS, or small-angle neutron scattering.

Although Eq. 3 correctly describes neutron scattering at *any* scattering angle, when the magnitude of \mathbf{Q} is very small compared to a typical interatomic distance, the exponential factors in Eq. 3 do not vary much from atom to atom, and the sum over the atomic sites may be replaced by an integral. As a result, the small-angle scattering law for coherent, elastic scattering from an assembly of “objects” (such as those depicted in Fig. 13 in the main text) can be written

$$I(\mathbf{Q}) = \left| \int b(\mathbf{r}) e^{-i\mathbf{Q}\cdot\mathbf{r}} d^3r \right|^2, \quad (11)$$

where $b(\mathbf{r})$ is the scattering-length density and the integral extends over the entire sample. To calculate $b(\mathbf{r})$ for a large molecule, for example, we simply add up the coherent scattering lengths of the atoms in the molecule and divide by the molecular volume. Equation 11 is essentially a coarse-grained version of the “truth” given by Eq. 3 and is valid only when Q is small. However, it is the basic analytic tool of small-angle scattering. ■

PUB 89 156-6

Roger Pynn was born and educated in England. He received his M. A. from the University of Cambridge in 1966 and his Ph.D. in neutron scattering, also from the University of Cambridge, in 1969. He was a Royal Society European Fellow to Sweden in 1970; he did two years of postdoctoral research in Norway; and then he was an associate physicist for two years at Brookhaven National Laboratory. After spending eleven years at the world's leading center for neutron scattering, the Institut Laue Langevin in Grenoble, France, he was appointed as the Director of the Manuel Lujan, Jr. Neutron Scattering Center at Los Alamos.

Acknowledgments

I would like to thank the staff of *Los Alamos Science* for encouraging me to write this article in a coherent fashion and for being patient throughout its many iterations.

Further Reading

G. L. Squires. 1978. *Introduction to Thermal Neutron Scattering*. Cambridge: Cambridge University Press.

C. G. Windsor. 1981. *Pulsed Neutron Scattering*. London: Taylor and Francis.

Physics Today, January 1985. A special issue on neutron scattering.

