Question(s): 12/15

Geneva, 5-16 December 2011

TEMPORARY DOCUMENT**Source:** Editor G.8110.1/Y.1370.1**Title:** Draft revised Recommendation ITU-T G.8110.1/Y.1370.1 (for Approval)

Recommendation ITU-T G.8110.1/Y.1370.1**Architecture of MPLS Transport Profile (MPLS-TP) layer network****Summary**

This Recommendation provides functional components, based on [ITU-T G.805], that allow Multi-Protocol Label Switching (MPLS) Transport Profile (MPLS-TP) to be modelled in a way that is consistent with the description of other transport technologies (e.g. Synchronous Digital Hierarchy (SDH), Optical Transport Network (OTN)) defined by the ITU-T to simplify integration with other transport technologies.

~~This Recommendation complies with the transport profile of MPLS Architecture as defined by the IETF. In the event of a difference between this ITU-T Recommendation and any of the normatively referenced IETF RFCs, the RFCs will take precedence.~~

This Recommendation provides a representation of the MPLS-TP technology using the methodologies that have been used for other transport technologies (e.g. SDH, OTN and Ethernet).

The representation of MPLS-TP provided in this ITU-T Recommendation is not intended to modify MPLS as defined by the IETF RFCs normatively referenced by this Recommendation.

In this Recommendation the architecture of MPLS-TP forwarding, Operation, Administration and Maintenance (OAM) and network survivability is modelled from a network-level viewpoint. The description of the control plane and management plane aspects of MPLS-TP is outside the scope of this Recommendation.

The functional components described in this Recommendation also support the architecture for point-to-multipoint (p2mp) MPLS-TP Label Switched Paths (LSPs) in compliance with [IETF RFC 5331] and [IETF RFC 5332].

Contact: Italo Busi
Alcatel-Lucent
ItalyTel: +39 039 686 7054
Email: Italo.Busi@alcatel-lucent.com

Attention: This is not a publication made available to the public, but an **internal ITU-T Document** intended only for use by the Member States of ITU, by ITU-T Sector Members and Associates, and their respective staff and collaborators in their ITU related work. It shall not be made available to, and used by, any other persons or entities without the prior written consent of ITU-T.

CONTENTS

1	Scope.....	4
2	References.....	656
3	Definitions	878
4	Abbreviations.....	1089
5	Conventions	1244
6	Functional architecture of MPLS Transport Profile (MPLS-TP) networks	13442
6.1	MPLS-TP Network layered structure.....	1342
6.1.1	MPLS-TP Adapted Information (MT_AI)	151344
6.1.2	MPLS-TP Characteristic Information	1514
6.2	MPLS-TP Layer Network	161415
6.2.1	MPLS-TP Topological Components	181617
6.2.2	MPLS-TP Transport Entities.....	191718
6.2.3	MPLS-TP Transport Processing Functions.....	191718
6.2.4	MPLS-TP Reference Points	201819
6.3	MPLS-TP Layer Network Partitioning	211920
6.4	MPLS-TP network topology	211920
6.4.1	Unidirectional and bidirectional connections and trails.....	211920
6.4.2	Point-to-multipoint connections and trails	211920
6.5	MPLS-TP Label Behaviour.....	242223
6.5.1	MPLS Label values	252324
6.5.2	Label Manager.....	252324
6.5.3	Labels for p2mp LSPs	252324
7	Server/client associations.....	252324
7.1	MT/client adaptation	252324
7.1.1	MT/ETH adaptation.....	252324
7.2	MT/MT adaptation	262425
7.3	Server/MT adaptation.....	272526
8	MPLS-TP OAM Architecture.....	292728
8.1	General	292728
8.1.1	Management and Control communications.....	292728
8.1.2	Server/client interaction.....	302728
8.1.3	MPLS-TP maintenance entity groups	3028
8.2	MPLS-TP connection and trail supervision	323031

8.2.1	Inherent monitoring.....	323031
8.2.2	Non-intrusive monitoring.....	323031
8.2.3	Intrusive monitoring.....	323031
8.2.4	Trail monitoring.....	333132
8.2.5	Sublayer monitoring.....	333132
8.3	MPLS-TP Maintenance Entity Group monitoring.....	343233
8.3.1	Pro-active monitoring.....	343233
8.3.2	On-demand monitoring.....	343233
8.4	MPLS-TP MIP.....	353334
8.5	Bandwidth considerations with MPLS-TP OAM.....	353334
9	MPLS-TP survivability techniques.....	363435
10	MPLS-TP Diff-Serv Architecture.....	363435
10.1	Short-Pipe Model.....	373536
10.2	Uniform Model.....	383538
11	MPLS-TP TTL Behaviour.....	393639
12	Security aspects.....	393639
Annex A	403740
Default configuration options for MPLS-TP in a Transport Network Application.....		403740
Appendix I	483941
An example of MPLS-TP layer structure.....		483941
Bibliography.....		554648

Recommendation ITU-T G.8110.1/Y.1370.1

Architecture of MPLS Transport Profile (MPLS-TP) layer network

Document History	
Issue	Notes
1.7.8	Draft – Updated at the December 2011 SG15 plenary meeting in Geneva
1.7.7	Draft – Updated based on AAP LC comments resolution (TD601r1/WP3)
1.7.6	Draft – Updated after the February 2011 SG15 plenary meeting in Geneva as per TD458/PLEN instructions
1.7.5	Draft – Updated at November 2010 Q12/15 interim meeting in Berlin
1.7.4	Draft – Input to the November 2010 Q12/15 interim meeting in Berlin
1.7.3	Draft – Updated at June 2010 SG15 plenary meeting in Geneva
1.7.2	Draft – Updated at April 2010 Q12/15 interim meeting in Stockholm
1.7.1	Draft – Updated during drafting at October 2009 SG15 plenary meeting in Geneva and after editorial clean up. Further updates, aimed at describing support of p2mp MPLS-TP LSPs via normative references to RFC 5331 and RFC 5332 avoiding normative references to draft-ietf-mpls-tp-p2mp-framework (in line with the outcome of the discussion at the IETF weekly call on 23 February 2010).
1.7	Draft – Updated after MEAD review
1.6	Draft – Updated after the first MEAD team call
1.5.3	Draft – Updated after discussion with IETF&MEAD team experts
1.5.2	Draft – Updated Editor’s proposal to address the comments from IETF&MEAD team experts
1.5.1	Draft – Editor’s proposal to address the first set of comments from IETF&MEAD team experts
1.4	Draft – Input to the IETF&MEAD team experts review
1.3	Draft – Output of the May 2009 Q12/15 interim meeting in Sophia Antipolis Note – Appendix II has not been yet updated. This update will be done via correspondence.
1.2	Draft – Input to the May 2009 Q12/15 interim meeting in Sophia Antipolis Editor’s proposal for aligning G.8110.1 with the IETF MPLS-TP Architecture and Framework
1.1	Draft – Output of the April 2006 interim meeting in Kobe
1.0	Initial version

Formatted: English (U.K.)

1 Scope

This Recommendation provides the functional components, based on [ITU-T G.805], necessary to describe the deployment of MPLS TP in a ~~Packet-Transport Network (PTN)~~. This model allows MPLS-TP to be modelled in a way that is consistent with the description of other transport technologies (e.g. SDH, OTN) defined by the ITU-T. ~~Additional functional components will be added in future versions of this Recommendation, if required, to describe the use of MPLS-TP in a more generalized Packet Switched Network (PSN) application.~~

~~This Recommendation complies with the transport profile of MPLS Architecture as defined by the IETF in [IETF RFC 5921], [IETF [RFC 5922](#)] and [IETF RFC 5960]. Further details of the MPLS TP architecture are provided by other framework documents such as [IETF [RFC 5923](#)],~~

[b IETF ~~[b sp-13]~~], [b IETF RFC 5950] and [b IETF ~~[b sp-13]~~]. In the event of a difference between this ITU-T Recommendation and any of the normatively referenced IETF RFCs, the RFCs will take precedence.

This Recommendation provides a representation of the MPLS-TP technology using the methodologies that have been used for other transport technologies (e.g. SDH, OTN and Ethernet).

The representation of MPLS-TP provided in this ITU-T Recommendation is not intended to modify MPLS as defined by the IETF RFCs normatively referenced by this Recommendation.

MPLS-TP is a connection-oriented packet-switched transport layer network technology that uses PWs and MPLS-TP LSPs, and PWs, MPLS-TP is a profile of MPLS. MPLS-TP is a profile of MPLS that supports deployment in transport networks and allows consistent operations in a manner consistent with other transport technologies. Its operation is also-independent of the mechanisms used for configuration and management. In the PTN some applications the data plane only supports forwarding based on the MPLS label, it does not support IP forwarding.

~~In a PSN application MPLS-TP is may be used as a server layer network to provide connection oriented packet transport capability (i.e., traffic engineering and enhanced OAM) to an existing IP/MPLS network. The primary requirements are driven by a desire for compatibility with the existing packet-switched network operational processes and in particular compatibility with the existing IP/MPLS OAM mechanisms. In this application the default OAM tools defined in [ITU-T G.8113.2] are typically used.~~

~~In a PTN application MPLS-TP is may also be used to add connection-oriented packet transport capability to an existing circuit-switched (SDH/OTN) and packet-switched (Ethernet) transport network. This connection-oriented packet transport capability is deployed and operated in a manner that is similar to the existing circuit-switched transport network in particular compatibility with the existing OAM mechanisms defined in [ITU-T G.8013/Y.1731] is required. In this application multi-technology transport nodes, which support multiple transport layer networks (e.g. Ethernet, OTN and SDH), are deployed. In this application the optional OAM mechanisms defined in [ITU-T G.8113.1] are typically used. Reference scenarios for the interconnection of domains that use the default OAM mechanisms defined in [ITU-T G.8113.2] and domains that use the optional OAM mechanisms defined in [ITU-T G.8113.1] are provided in annex B.~~

In a PSN application MPLS-TP is used as a server layer network to provide connection oriented packet transport capability (i.e., traffic engineering and enhanced OAM) to an existing IP/MPLS network. The primary requirements are driven by a desire for compatibility with the existing packet-switched network operational processes and in particular compatibility with the existing IP/MPLS OAM mechanisms.

MPLS-TP is a connection-oriented packet-switched transport layer network technology that uses MPLS-TP LSPs and PWs, MPLS-TP is a profile of MPLS.

This Recommendation complies with the transport profile of MPLS Architecture as defined by the IETF in [IETF RFC 5921], [IETF ~~[b sp-13]~~] and [IETF RFC 5960]. Further details of the MPLS-TP architecture are provided by other framework documents such as [IETF ~~[b sp-13]~~], [b IETF ~~[b sp-13]~~], [b IETF RFC 5950] and [b IETF ~~[b sp-13]~~]. In the event of a difference between this ITU-T Recommendation and any of the normatively referenced IETF RFCs, the RFCs will take precedence. In the PTN application the OAM mechanisms defined in [ITU-T G.8113.1] are used, the interconnection of networks that run PTN and PSN OAM mechanisms is described in annex B.

Formatted: Tab stops: 1.4 cm, Left + 2.1 cm, Left + 2.8 cm, Left + 3.5 cm, Left + Not at 14.72 cm

Formatted: Font: (Asian) MS Mincho

Comment [Z21]: Text moved from below (ref. #2, #3 and #4). Revision bars mark proposed changes to the moved text.

Formatted: Not Highlight

Comment [Z22]: Text moved from below (ref. #5). Revision bars mark proposed changes to the moved text.

Formatted: Not Highlight

Formatted: Not Highlight

Comment [Z23]: Text moved above (ref. #5)

Comment [Z24]: Text moved above (ref. #2)

The architecture of MPLS-TP forwarding, OAM and network survivability is modelled from a network-level viewpoint. The description of the control plane and management plane aspects of MPLS-TP is outside the scope of this Recommendation.

The functional components described in this Recommendation also support the architecture for p2mp MPLS-TP LSPs in compliance with [IETF RFC 5331] and [IETF RFC 5332].

As MPLS-TP is a profile of MPLS, this Recommendation uses the applicable functional components provided in the MPLS Layer Network Architecture of [ITU-T G.8110] and extends them with additional capabilities (e.g. OAM and protection) that are not modelled in [ITU-T G.8110].

~~MPLS-TP is a connection-oriented packet-switched transport layer network technology that uses MPLS-TP LSPs and PWs. MPLS-TP is a profile of MPLS that supports deployment in transport networks and allows consistent operations with other transport technologies. In the PTN application MPLS-TP is deployed and operated in a manner that is similar to the existing circuit-switched transport network and therefore must be compatible with the existing transport network operational processes. MPLS-TP operates independently of its client and server layer networks. Its operation is also independent of the mechanisms used for configuration and management. In the PTN application the data plane only supports forwarding based on the MPLS label, it does not support IP forwarding.~~

Comment [Z25]: Duplicated text

Comment [Z26]: Text moved above (ref. #3)

Comment [Z27]: Duplicated text

Comment [Z28]: Text moved above (ref. #4)

This version of this Recommendation only provides those functional components (based on G.805) and architectural models required to model an Ethernet service carried by a Single-Segment Pseudowire (PW) (SS-PW) over co-routed bi-directional LSPs, which may be hierarchical, and do not use Penultimate Hop Popping (PHP), which may be hierarchical.

Other clients for LSPs (e.g. Internet Protocol (IP)) and PWs and modes of operation (e.g. Multi-Segment Pseudowire (MS-PW), associated bi-directional LSPs) as described in [IETF RFC 5921] are supported as defined in [IETF RFC 5921] and [IETF ~~sp-ans-ann~~ RFC 6215] but are not modelled in this version of the Recommendation. They will be added in future versions of this Recommendation.

2 References

The following ITU-T Recommendations and other references contain provisions which, through reference in this text, constitute provisions of this Recommendation. At the time of publication, the editions indicated were valid. All Recommendations and other references are subject to revision; users of this Recommendation are therefore encouraged to investigate the possibility of applying the most recent edition of the Recommendations and other references listed below. A list of the currently valid ITU-T Recommendations is regularly published. The reference to a document within this Recommendation does not give it, as a stand-alone document, the status of a Recommendation.

- [ITU-T G.805] ITU-T Recommendation G.805 (2000), *Generic functional architecture of transport networks*.
- [ITU-T G.806] ITU-T Recommendation G.806 (2009), *Characteristics of transport equipment – Description methodology and generic functionality*.
- [ITU-T G.808.1] ITU-T Recommendation G.808.1 (~~2006~~2010), *Generic protection switching – Linear trail and subnetwork protection*.
- [ITU-T G.8010] ITU-T Recommendation G.8010/Y.1306 (2004), *Architecture of Ethernet layer networks*.

- [ITU-T G.8013] [ITU-T Recommendation G.8013/Y.1731 \(2011\), OAM functions and mechanisms for Ethernet based networks, plus Corrigendum 1 \(2011\).](#)
- [ITU-T G.8080] ITU-T Recommendation G.8080/Y.1304 (2006), *Architecture for the automatically switched optical network (ASON).*
- [ITU-T G.8101] [ITU-T Recommendation G.8101/Y.1355 \(2010\), Terms and definition for MPLS transport profile.](#)
- [ITU-T G.8110] ITU-T Recommendation G.8110/Y.1370 (2005), *MPLS layer network architecture.*
- ~~[ITU-T G.8113.1] ITU-T Recommendation G.8113.1 (2011), Operations, Administration and Maintenance mechanism based on Y.1731 for MPLS TP networks using the tools defined in G.8013/Y.1731.~~
- ~~[ITU-T G.8113.2] ITU-T Recommendation G.8113.2 (2011), Operations, Administration and Maintenance mechanism for MPLS-TP networks using the tools defined for MPLS.~~
- ~~<<NOTE TO TSB Update the reference to G.8113.1, and G.8113.2 and G.8013 Corrigendum 1 once it is they are approved >>~~
- ~~[ITU-T G.7710] ITU-T Recommendation G.7710/Y.1701 (2007), Common equipment management function requirements.~~
- [ITU-T G.7712] ITU-T Recommendation G.7712/Y.1703 (2010), *Architecture and specification of data communication network.*
- [ITU-T M.1400] [ITU-T Recommendation M.1400 \(2006\), Designations for interconnections among operators' networks.](#)
- ~~[ITU-T X.731] ITU-T Recommendation X.731 (1992), Information technology - Open Systems Interconnection - Systems Management: State management function.~~
- [ITU-T Y.1415] ITU-T Recommendation Y.1415 (2005), *Ethernet-MPLS network interworking – User plane interworking.*
- [IETF RFC 3031] IETF RFC 3031 (2001), *Multiprotocol label switching architecture.*
- [IETF RFC 3032] IETF RFC 3032 (2001), *MPLS label stack encoding.*
- [IETF RFC 3270] IETF RFC 3270 (2002), *Multi-Protocol Label Switching (MPLS) Support of Differentiated Services.*
- [IETF RFC 3443] IETF RFC 3443 (2003), *Time To Live (TTL) Processing in Multi-Protocol Label Switching (MPLS) Networks.*
- [IETF RFC 4385] IETF RFC 4385 (2006), *Pseudowire Emulation Edge-to-Edge (PWE3) Control Word for Use over an MPLS PSN.*
- [IETF RFC 4448] IETF RFC 4448 (2006), *Encapsulation Methods for Transport of Ethernet over MPLS Networks.*
- [IETF RFC 4720] IETF RFC 4720 (2006), *Pseudowire Emulation Edge-to-Edge (PWE3) – Frame Check Sequence Retention.*
- [IETF RFC 4875] IETF RFC 4875 (2007), *Extensions to Resource Reservation Protocol - Traffic Engineering (RSVP-TE) for Point-to-Multipoint TE Label Switched Paths (LSPs).*

Formatted: English (U.S.)

Formatted: English (U.S.)

Formatted: Not Highlight

Formatted: Not Highlight

Formatted: Not Highlight

Formatted: Not Highlight

- [IETF RFC 5331] IETF RFC 5331 (2008), *MPLS Upstream Label Assignment and Context-Specific Label Space*.
- [IETF RFC 5332] IETF RFC 5332 (2008), *MPLS Multicast Encapsulations*.
- [IETF RFC 5462] IETF RFC 5462 (2009), *Multiprotocol Label Switching (MPLS) Label Stack Entry: "EXP" Field Renamed to "Traffic Class" Field*.
- [IETF RFC 5586] IETF RFC 5586 (2009), *MPLS Generic Associated Channel*.
- [IETF RFC 5718] IETF RFC 5718 (2010), *An Inband Data Communication Network For the MPLS Transport Profile*.
- [IETF RFC 5654] IETF RFC 5654 (2009), *MPLS-TP Requirements*.
- [IETF RFC 5860] IETF RFC 5860 (2010), *Requirements for Operations, Administration, and Maintenance (OAM) in MPLS Transport Networks*.
- [IETF RFC 5921] IETF RFC 5921(2010), *A Framework for MPLS in Transport Networks*.
- [IETF ~~tp-uni-net~~RFC 6215] IETF ~~Internet-Draft-draft-ietf-mpls-tp-uni-net-02.txt~~RFC 6215 (2011), *MPLS Transport Profile User-to-Network and Network-to-Network Interfaces*.
- [IETF RFC 5960] IETF RFC 5960 (2010), *MPLS Transport Profile Data Plane Architecture*, plus Errata 2533 (2010) and Errata 2534 (2010).
- [IETF RFC 6370~~tp-ident~~] IETF ~~Internet-Draft-draft-ietf-mpls-tp-identifiers-04.txt~~RFC 6370 (2011), *MPLS Transport Profile (MPLS-TP) Identifiers*~~MPLS-TP Identifiers~~.
- [IETF RFC 6371~~tp-oam-fw~~] IETF ~~Internet-Draft-draft-ietf-mpls-tp-oam-framework-11.txt~~RFC 6371 (2011), *Operations, Administration, and Maintenance Framework for MPLS-Based Transport Networks*~~Operations, Administration and Maintenance Framework for MPLS-based Transport Networks~~.

Formatted: Not Highlight

Formatted: Not Highlight

Formatted: Not Highlight

~~<<NOTE TO TSB Update the references to the Internet Drafts above with the approved RFCs on MPLS-TP when available>>~~

3 Definitions

This Recommendation uses the following terms defined in [ITU-T ~~G.805~~G.8101]:

- 3.1 access point
- 3.2 adapted information
- 3.3 administrative domain
- 3.4 characteristic information
- 3.5 client/server relationship
- 3.6 connection
- 3.7 connection point
- 3.8 connection supervision
- 3.9 layer network
- 3.10 link
- 3.11 link connection

- 3.12 network
- 3.13 network connection
- 3.14 reference point
- 3.15 sublayer
- 3.16 subnetwork
- 3.17 subnetwork connection
- 3.18 tandem connection
- 3.19 termination connection point
- 3.20 trail
- 3.21 trail termination
- 3.22 transport
- 3.23 transport entity
- 3.24 transport processing function
- 3.25 unidirectional connection

~~This Recommendation uses the following terms defined in [IETF RFC 3031]:~~

- 3.26 label
- 3.27 label stack
- 3.28 label switched path
- 3.29 MPLS label stack

~~This Recommendation uses the following terms defined in [IETF RFC 3032]:~~

- 3.30 bottom of stack
- 3.31 label value
- 3.32 time to live

~~This Recommendation uses the following terms defined in [IETF RFC 3270]:~~

- 3.33 label inferred PHB scheduling class LSP
- 3.34 per hop behaviour

~~This Recommendation uses the following terms defined in [IETF RFC 5462]:~~

- 3.35 Explicitly TC-encoded-PSC LSP
- 3.36 traffic class

~~This Recommendation uses the following terms defined in [IETF RFC 5586]:~~

- 3.37 Associated Channel Header
- 3.38 Generic Associated Channel
- 3.39 G-ACh packet
- 3.40 G-ACh packet payload

~~This Recommendation uses the following terms defined in [ITU T G.808.1]:~~

3.41 network survivability

3.42 protection

3.43 restoration

This Recommendation uses the following terms defined in [ITU-T X.731]:

3.44 administrative state

This Recommendation uses the following terms defined in [ITU-T G.8010]:

3.45 maintenance entity group

3.46 maintenance entity

3.47 maintenance entity group intermediate point compound function

3.48 pro-active monitoring

3.49 on-demand monitoring

This Recommendation uses the following terms defined in [IETF RFC 5921]:

3.50 MPLS Transport Profile (MPLS-TP)

3.51 MPLS-TP LSP

3.51.3.52 Pseudowire

Formatted: French (Switzerland)

Formatted: Bullets and Numbering

Formatted: Bullets and Numbering

4 Abbreviations

This Recommendation uses the following abbreviations:

ACH Associated Channel Header

AI Adapted Information

AP Access Point

APS Automatic Protection Switching¹

CI Characteristic Information

CII Common Interworking Indicators

CW Control Word

CO-PS Connection-Oriented Packet Switched

CP Connection Point

D Data (i.e., traffic unit)

DE Drop Eligibility

ECC Embedded Communication Channels²

ECMP Equal Cost Multi-Path

E-LSP Explicitly TC-encoded-PSC LSP

ETH Ethernet MAC layer network

Formatted: English (U.K.)

¹ The IETF has not yet selected a term for this set of functions.

² The IETF uses the term CCh

FP	Flow Point
GAL	Generic Associated Channel (G-ACh) Label
G-ACh	Generic Associated Channel
<u>ICC</u>	<u>ITU Carrier Code</u>
IP	Internet Protocol
iPHB	Incoming Per Hop Behaviour
LC	Link Connection
L-LSP	Label-Only-Inferred PSC LSP
LSE	Label Stack Entry
LSP	Label Switched Path
<u>MCC</u>	<u>Management Communication Channel</u>
<u>MCN</u>	<u>Management Communication Network</u>
ME	Maintenance Entity
MEG	Maintenance Entity Group
MEP	Maintenance entity group End Point
MIP	Maintenance entity group Intermediate Point
MPLS	Multi-Protocol Label Switching
MPLS-TP	Multi-Protocol Label Switching – Transport Profile
MS-PW	Multi-Segment Pseudowire
MT	Multi-Protocol Label Switching – Transport Profile
MTD	MPLS-TP Diagnostic function
MTDi	MPLS-TP Diagnostic function within MT MIP
MTS	MPLS-TP Section
NC	Network Connection
NE	Network Element
NSP	Native Service Processing
NMS	Network Management System
OAM	Operation, Administration and Maintenance
ODU	Optical channel data unit
oPHB	Outgoing Per Hop Behaviour
OTH	Optical Transport Hierarchy
OTN	Optical Transport Network
p2mp	point-to-multipoint
p2p	point-to-point
P	Priority

Formatted: Don't keep with next

Formatted: French (France)

PHB	Per Hop Behaviour
PHP	Penultimate Hop Popping
PSC	PHB Scheduling Class
PW	Pseudowire
S-bit	Bottom of Stack Indicator
SCC	Signalling Communication Channel
SCN	Signalling Communication Network
SDH	Synchronous Digital Hierarchy
Sk	Sink
SN	Subnetwork
SNC	Subnetwork Connection
SNC/S	SNCP with Sublayer monitoring
SNCP	Subnetwork Connection Protection
So	Source
SPME	Sub-Path Maintenance Element
SSF	Server Signal Fail ³
SS-PW	Single-Segment Pseudowire
TC	Traffic Class
TCM	Tandem Connection Monitoring
TCP	Termination Connection Point
TSD	Trail Signal Degrade
TSF	Trail Signal Fail
TT	Trail Termination
TTL	Time-To-Live
VC	Virtual Container

5 Conventions

The diagrammatic convention for connection-oriented layer networks described in this Recommendation is that of [ITU-T G.805].

All transport entities within this Recommendation are unidirectional unless explicitly specified otherwise.

The diagrammatic conventions for Maintenance Entity (ME) Group (MEG) End Point (MEP) and MEG Intermediate Point (MIP) compound functions are those of [ITU-T G.8010].

³ The IETF has not yet selected a term for this abstract information element.

6 Functional architecture of MPLS Transport Profile (MPLS-TP) networks

The complete architecture of MPLS-TP is defined by the IETF in [IETF RFC 5921] and [IETF RFC 6215]. Further details of the MPLS-TP architecture are provided by other framework documents such as [IETF RFC 6371], [b-IETF RFC 6372], [b-IETF RFC 5950], and [b-IETF RFC 6373] and [b-IETF RFC 6373] and [b-IETF RFC 6373].

The requirements for MPLS-TP forwarding, OAM and network survivability are described in [IETF RFC 5654] and [IETF RFC 5860].

The MPLS-TP framework is described in [IETF RFC 5921] and [IETF RFC 6215]. The MPLS-TP OAM framework and architecture is defined in [IETF RFC 6371]. The MPLS-TP protection switching framework and architecture are based on [ITU-T G.808.1] and described in [b-IETF RFC 6372]. The structure of the identifiers for the transport entities are defined in [IETF RFC 6370] for further study.

NOTE – The information content of the identifiers for the transport entities is defined in [IETF RFC 6370] which specifies the use of the IP based Global ID to uniquely identify a network operator. An alternative way to uniquely identify a network operator using the combination of the Country Code (CC), as defined in [ITU-T G.8013] and the ITU carrier code (ICC), as defined in [ITU-T M.1400], will be defined in [b-IETF RFC 6370].

Formatted: Note

Formatted: Highlight

Formatted: Highlight

Control and management plane aspects are outside the scope of this Recommendation.

This Recommendation provides functional components (based on G.805) that allow MPLS-TP to be modelled in a way that is consistent with the description of other transport technologies defined by the ITU-T. The functional description provided in this Recommendation is generic and no particular physical partitioning of the functions is implied.

These functional components support the architecture for p2mp MPLS-TP LSPs in compliance with [IETF RFC 5331] and [IETF RFC 5332]. Further details on p2mp MPLS-TP LSPs and PWs are under definition in IETF and future versions of this Recommendation may be updated to include this new material.

The current version of this Recommendation only provides those functional components (based on G.805) and architectural models required to model Ethernet carried by a SS-PW over hierarchical co-routed bi-directional LSPs in the network scenario provided in annex A.

MPLS-TP supports other clients for LSPs (e.g. IP) and PWs, multi-segment PW (MS-PW) and non-DiffServ Traffic Engineered (TE) LSPs as described in [IETF RFC 5921] and [IETF RFC 6215]. Models for these clients and other modes of operations will be added to future versions of this Recommendation.

MPLS-TP conformant equipment may support additional MPLS features. These additional MPLS features are outside the scope of this Recommendation.

6.1 MPLS-TP Network layered structure

One layer network is defined to model the MPLS-TP network architecture, which is defined in [IETF RFC 5921]:

- MPLS-TP Layer Network.

The MPLS-TP layer network is a path layer network as defined in clause 6.2 of [ITU-T G.8110].

The MPLS-TP layer network may be deployed recursively to provide an MPLS-TP hierarchy implemented as a label stack as per [IETF RFC 5921]. In this Recommendation, this is described by the use of sub-layering as defined in clause 8.1 of [ITU-T G.8110].

PWs can only be carried over the server layer network as specified by IETF PWE3 WG. This Recommendation describes carrying PWs over MPLS-TP LSPs. PWs in MPLS-TP can only be carried over MPLS-TP LSPs.

The MPLS architecture does not have a minimum packet length. When MPLS packets are transmitted over a non-MPLS-TP server layer with a minimum frame size, the Server/MPLS-TP adaptation function will pad these packets to the minimum frame size of that non-MPLS-TP server layer. This padding is removed at the adaptation sink of the non-MPLS client. The mechanisms for mapping clients over MPLS-TP provide appropriate information (e.g. the length field in the Control Word) to remove the padding at that MPLS-TP/Client adaptation sink function.

In normal operations, all packets with the same class of service sent over an MPLS-TP connection are delivered in order; see [IETF RFC 5921]. This means that, under normal conditions, all the packets sent over a PW or Explicitly Traffic Class (TC)-encoded Per Hop Behaviour (PHB) Scheduling Class (PSC) LSP (E-LSP) within the same class of service are delivered in order and that all the packets sent over an Label-Only-Inferred PSC LSP (L-LSP) are delivered in order (because L-LSPs support only a single class of service).

NOTE – The mapping of a client over MPLS-TP must be handled to respect ordering requirement for the client. Mechanisms to achieve this are client layer specific and outside the scope of this Recommendation.

At domain boundaries, an instance of a layer or sub-layer playing a specific role in one domain may continue in the adjacent domain in another role. Roles describe particular client/server layer relationships. The Characteristic Information (CI) of the layer is the only necessary condition for how the layer continues between domains. In G.805 terms, the server of a client/server relationship in one domain might be a client in the adjacent domain.

As applied to MPLS-TP domains, the layer instances of a MPLS-TP hierarchy may be described in terms of their role in the hierarchy. These roles are channel, path, and section. At a boundary between two domains, an MPLS-TP Section in one domain could continue as an MPLS-TP Path in the adjacent domain. In MPLS-TP the instantiation of a Sub-Path Maintenance Element (SPME) for an LSP creates a new sub-layer but does not change the role of the LSP with respect to the MPLS-TP connection the SPME is associated with.

~~Figure 6-1~~ Figure 6-1 illustrates that LSP2 has a MPLS-TP Path role in Domain 2 and a MPLS-TP Section role in Domain 1.

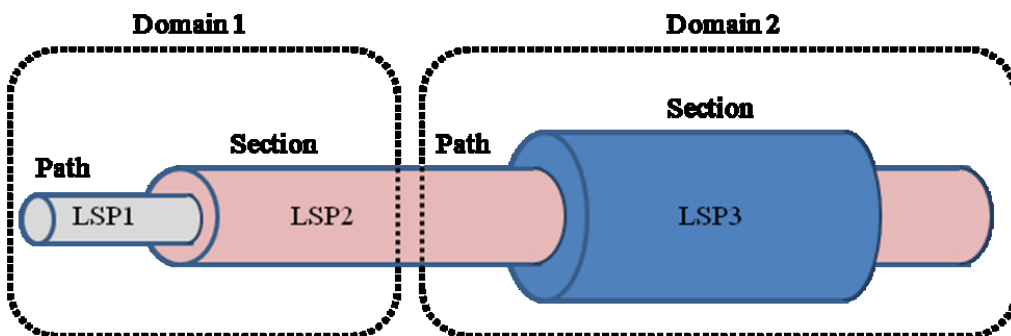

Figure 6-1 – MPLS-TP roles and layers

6.1.1 MPLS-TP Adapted Information (MT_AI)

The MPLS-TP layer network adapted information is a flow of MT_AI Data (MT_AI_D) traffic units accompanied by the MT_AI_PHB, MT_AI_TSD and MT_AI_TSF signals.

The MT_AI traffic unit consists of an MT_AI header containing the Bottom of Stack Indicator (S-bit) field of the MPLS shim header and an MPLS payload field. ~~Figure 6-2~~~~Figure 6-2~~~~Figure 6-2~~ below provides a graphical representation of the MT_AI traffic unit format.

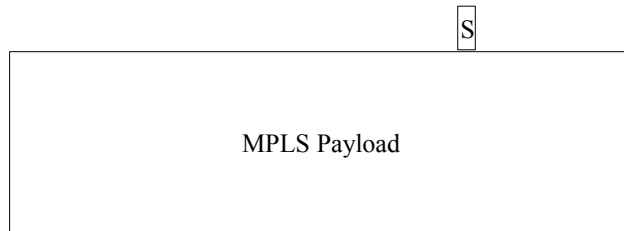

Figure 6-2 – MT_AI Traffic Unit

NOTE – The definition of the MT_AI traffic unit is based on the MPLS_AI traffic unit as defined in clause 6.2.1 of [ITU-T G.8110].

The MPLS payload field carries either the encapsulated client information or the encapsulated information from communication channels that are associated with the MPLS-TP trail (e.g. Signalling Communication Network (SCN)).

The encapsulated client information is either a PW encapsulated client information (e.g. the Ethernet Service Payload with the Control Word, in case of an Ethernet client utilizing the Generic Associated Channel (G-ACh)), when the client layer network is a PW client, or, in case of MPLS-TP sub-layering, a labelled packet as defined in [IETF RFC 3031].

NOTE – Other clients are not prohibited and are for further study.

The MT_AI_PHB signal supports the Diff-Serv Architecture as described in clause ~~1040~~.

The MT_AI_TSF and MT_AI_TSD signals are MPLS-TP signal fail and signal degrade indication outputs at the Access Point (AP) of an MPLS-TP termination function as defined in [ITU-T G.806].

6.1.2 MPLS-TP Characteristic Information

The MPLS-TP layer network characteristic information is a flow of MT_CI Data (MT_CI_D) traffic units.

The MT_CI traffic unit (MT_CI_D) consists either of a MT_AI traffic unit (MT_AI_D) or of a MPLS-TP OAM traffic unit, extended with an MT_CI header containing the Time-To-Live (TTL) field of the MPLS shim header. ~~Figure 6-3~~~~Figure 6-3~~~~Figure 6-3~~ below provides a graphical representation of the MT_CI traffic unit format.

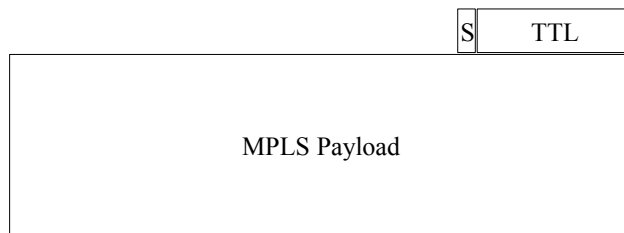

Figure 6-3 – MT_CI Traffic Unit

NOTE – The definition of the MT_CI traffic unit is based on the MPLS_CI traffic unit as defined in clause 6.2.2 of [ITU-T G.8110]. In line with [ITU-T G.8110] the MPLS label and TC fields are considered part of the MPLS header but associated with the MPLS-TP link and not with the MPLS_TP characteristic information.

The MPLS-TP OAM traffic unit contains the MPLS-TP OAM PDU (i.e. a G-ACh packet payload as defined in [IETF RFC 5586]).

~~In this Recommendation the assignment of the S and TTL fields in the LSP or PW Label Stack Entry (LSE) of a G-ACh packet is defined in the MPLS-TP Trail Termination (MT_TT) function; the assignment of the other fields is defined in the adaptation function.~~

Details for the insertion of G-ACh packets into MPLS-TP LSPs and PWs are defined in [IETF RFC 5586]. Note that for PWs, the PWE3 control word [IETF RFC 4385] is required in the encapsulation of user packets when the Associated Channel Header (ACH) is used to realize the associated control channel.

The MT_CI traffic units (MT_CI_D) are accompanied by the MT_CI_iPHB, MT_CI_oPHB, MT_CI_SSF and optional MT_CI_APS signals.

The MT_CI_iPHB and MT_CI_oPHB signals support the Diff-Serv Architecture as described in clause ~~1040~~.

The MT_CI_SSF signal is the MPLS-TP signal fail indication outputs at the Connection Point (CP) of a Server/MPLS-TP adaptation function as defined in [ITU-T G.806].

The MT_CI_APS is needed to support linear protection switching mechanisms as defined in [ITU-T G.808.1]. The MT_CI_APS will be defined in the in the Recommendations describing protection switching which are currently under development in ITU-T.

6.2 MPLS-TP Layer Network

The MPLS-TP layer network provides the transport of adapted information through a MPLS-TP trail between MPLS-TP access points. The logical association between these points is called a tunnel in the MPLS-TP RFCs. A tunnel is associated with one or more LSPs. The tunnel is one of the primary constructs that is identified and it is used to identify the LSPs that are associated with it, see [IETF [RFC 6370](#)~~rs-ident~~] for further details.

The MPLS-TP layer network characteristic information is transported over a MPLS-TP network connection. The MPLS-TP layer network contains the following transport processing functions, transport entities, topological components and reference points:

- MPLS-TP trail;
- MPLS-TP trail termination source (MT_TT_So);

- MPLS-TP trail termination sink (MT_TT_Sk);
- MPLS-TP network connection (MT_NC);
- MPLS-TP link connection (MT_LC);
- MPLS-TP subnetwork connection (MT_SNC);
- MPLS-TP subnetwork (MT_SN);
- MPLS-TP link;
- MPLS-TP access point (MT_AP);
- MPLS-TP connection point (MT_CP);
- MPLS-TP termination connection point (MT_TCP).

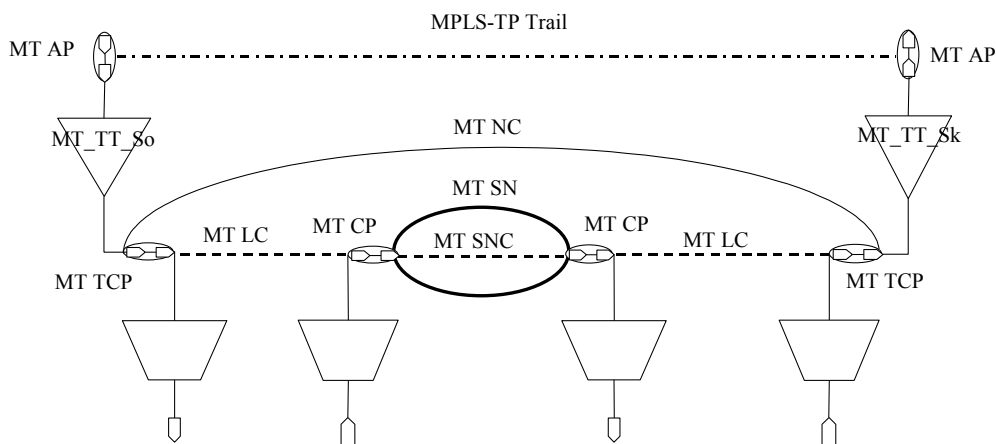

Figure 6-4 – MPLS-TP layer network example

Figure 6-5 depicts the MPLS-TP layer network structure when carrying an Ethernet client using a SS-PW over an LSP. When LSPs are nested the server trail in Figure 6-5 will be another MPLS-TP trail.

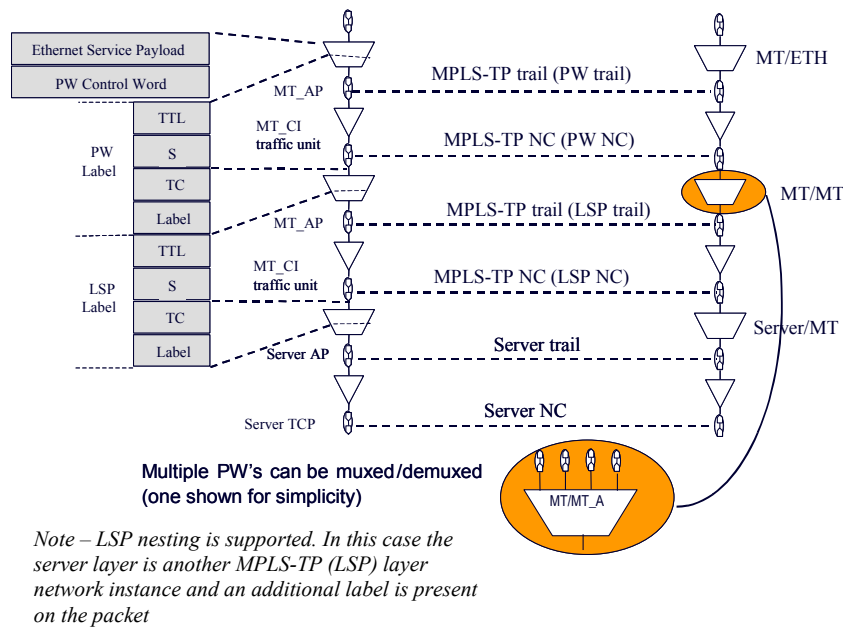

Figure 6-5 – MPLS-TP layer network structure example

6.2.1 MPLS-TP Topological Components

The MPLS-TP topological components are defined in clause 8.1.1 of [ITU-T G.8110]:

- MPLS-TP layer network;
- MPLS-TP subnetwork;
- MPLS-TP link;
- MPLS-TP access group.

6.2.1.1 MPLS-TP Layer Network

The MPLS-TP layer network is defined by the complete set of MPLS-TP access groups (see section [6.2.1.46-2-1.4](#)) that may be associated for the purpose of transferring information as defined in clause 8.1.1.1 of [ITU-T G.8110].

6.2.1.2 MPLS-TP Subnetwork

An MPLS-TP subnetwork is defined by the set of MPLS-TP connection points that are available for the purpose of transferring information as defined in clause 8.1.1.2 of [ITU-T G.8110].

6.2.1.3 MPLS-TP Link

A MPLS-TP link consists of a subset of the MPLS-TP connection points at the edge of one MPLS-TP subnetwork or MPLS-TP access groups (see section [6.2.1.46-2-1.4](#)) that are associated with a corresponding subset of MPLS-TP connection points at the edge of another MPLS-TP subnetwork or MPLS-TP access group for the purpose of transferring MPLS-TP characteristic information as defined in clause 8.1.1.3 of [ITU-T G.8110].

6.2.1.4 MPLS-TP Access Group

A MPLS-TP access group is a group of collocated MPLS-TP trail termination functions that are connected to the same MPLS-TP subnetwork or MPLS-TP link.

6.2.2 MPLS-TP Transport Entities

The MPLS-TP transport entities are:

- MPLS-TP link connection;
- MPLS-TP network connection;
- MPLS-TP subnetwork connection;
- MPLS-TP trail.

6.2.3 MPLS-TP Transport Processing Functions

The MPLS-TP transport processing functions are:

- MPLS-TP trail termination function;
- MPLS-TP/client layer network adaptation functions.

6.2.3.1 MPLS-TP Trail Termination

The bidirectional MPLS-TP trail termination (MT_TT) function is performed by a collocated pair of associated unidirectional MPLS-TP trail termination source (MT_TT_So) and sink (MT_TT_Sk) functions.

The MPLS-TP trail termination source (MT_TT_So) performs the following processes between its input and output:

- inserts the 8-bit TTL field;
- inserts MPLS-TP OAM traffic units extended with an MT_CI header (as defined in clause [6.1.26.1.2](#));
- outputs the resulting MT_CI.

The MPLS-TP trail termination sink (MT_TT_Sk) performs the following functions between its input and output:

- extracts and processes MPLS-TP OAM traffic units;
- extracts the 8-bit TTL field;
- outputs the resulting MT_AI.

6.2.3.2 MPLS-TP to client layer network adaptation functions

For the case when the client packets need to be forwarded to different destinations (based for example on configuration or on destination information in the client layer packets), the client traffic unit is delivered to different Connection Point/Flow Point (CP/FP) in the client layer network. The selection of the client layer CP/FP is in the scope of the client layer network and outside the scope of this Recommendation.

For the case of packet clients that include QoS information in each frame the MT/client adaptation function may support more than one access point. The access point is selected per frame based on the QoS information contained in the client layer. The QoS information is passed across the access point as AI_PHB parameter. The description of Diff-Serv support in MPLS-TP is provided in section [10.4](#).

For example, as defined in [IETF RFC 4448], it is possible that the traffic sent on a single client CP/FP is delivered to:

- 1) different PWs (one per each class of service of the client layer transport entity) where each of them is carried by different L-LSPs supporting the same CoS as the carried PW: in this case the MT/Client_A function has different APs (one per CoS) and the MT/MT_A function has one AP;
- 2) one PW, supporting all the classes of service of the client layer transport entity, that is then carried over an E-LSP supporting at least all the classes of service of the carried PW: in this case both the MT/Client_A and the MT/MT_A functions have a single AP;
- 3) one PW, supporting all the classes of service of the client layer transport entity, that is then carried over different L-LSPs (one for each class of service of the carried PW): in this case the MT/Client_A function as a single AP while the MT/MT_A function has different APs (one per CoS).

These examples are described in [Figure 6-6](#).

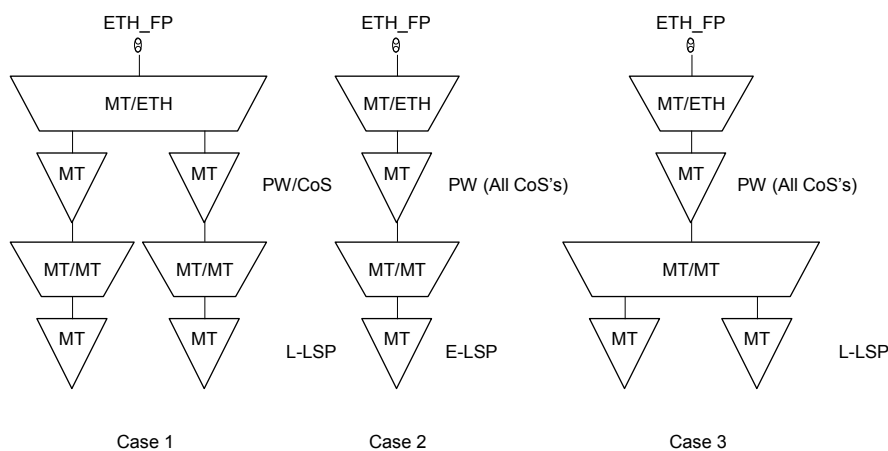

Figure 6-6 – Examples of QoS processing in MT/Client_A function

The MPLS-TP/client adaptation functions are described in clause [7.7](#).

6.2.4 MPLS-TP Reference Points

The MPLS-TP reference points are defined in clause 8.1.4 of [ITU-T G.8110]:

- MPLS-TP access point (MT AP);
- MPLS-TP connection point (MT CP);
- MPLS-TP termination connection point (MT TCP).

6.2.4.1 MPLS-TP Access Point

A MPLS-TP access point (MT AP) represents the binding between a MPLS-TP trail termination function and one or more MT/client, or MT/MT, adaptation functions as defined in clause 8.1.4.1 of [ITU-T G.8110].

6.2.4.2 MPLS-TP Connection Point

A MPLS-TP link connects to a MPLS-TP subnetwork or another MPLS-TP link via a MPLS-TP connection point (MT CP) as defined in clause 8.1.4.2 of [ITU-T G.8110].

6.2.4.3 MPLS-TP Termination Connection Point

A MPLS-TP termination connection point (MT TCP) connects a MPLS-TP trail termination (MT_TT) function with a MPLS-TP link as defined in clause 8.1.4.3 of [ITU-T G.8110].

6.3 MPLS-TP Layer Network Partitioning

The description of MPLS-TP layer network partitioning is the same as clause 8.2 of [ITU-T G.8110].

6.4 MPLS-TP network topology

An MPLS-TP layer network contains zero or more MT links and zero or more MT subnetworks.

MPLS-TP layers can support unidirectional and bidirectional point-to-point connections, and unidirectional point-to-multipoint connections between two or more connection points and/or termination connection points at the edges of the MPLS-TP layer network administrative domain.

This version of the Recommendation supports the following MPLS-TP connections, as defined in [IETF RFC 5921] and [IETF RFC 4875]:

- point-to-point single-segment PW (SS-PW)
- point-to-point unidirectional and co-routed bi-directional LSPs
- point-to-multipoint unidirectional LSPs

NOTE – [IETF RFC 4875] defines the p2mp LSPs as well as control plane aspects for setting up p2mp LSPs using RSVP-TE signalling. Additional description of p2mp LSPs is provided in [b-IETF RFC 4461].

Point-to-multipoint PWs are outside the scope of this version of the Recommendation.

The control plane aspects are out of the scope of this Recommendation.

6.4.1 Unidirectional and bidirectional connections and trails

A bidirectional connection in a server layer network may support either bidirectional or unidirectional MPLS-TP connections, but a unidirectional connection in the server layer network may only support unidirectional MPLS-TP connections.

6.4.2 Point-to-multipoint connections and trails

A unidirectional point-to-multipoint network connection broadcasts the traffic from the root MPLS-TP TCP to the leaf MPLS-TP TCPs as illustrated in [Figure 6-7](#)~~Figure 6-7~~.

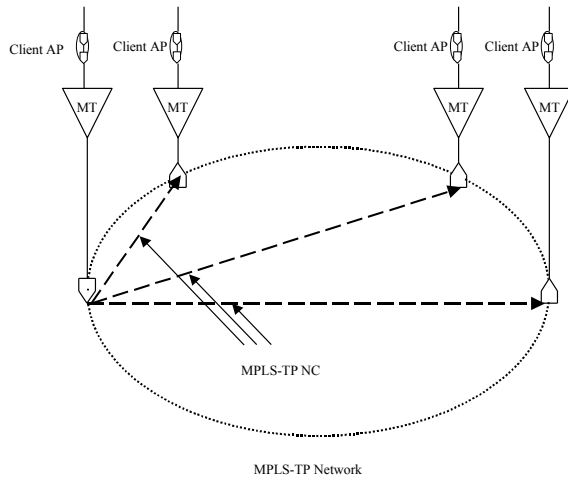

Figure 6-7 – Point-to-multipoint MPLS-TP connection

A point-to-multipoint MPLS-TP network connection can be decomposed into point-to-multipoint MPLS-TP subnetwork connections and point-to-point (p2p) MPLS-TP link connections as shown in [Figure 6-8](#)~~Figure 6-8~~~~Figure 6-8~~.

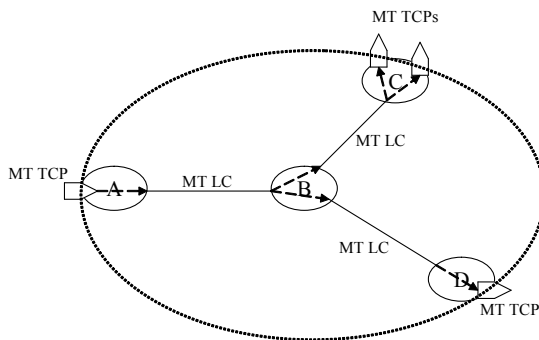

Figure 6-8 – MPLS-TP p2mp network connection using MPLS-TP p2p link connections

Subnetwork A will send a single copy of the traffic units from the MT TCP to the downstream subnetwork B via a point-to-point MPLS-TP LC. Subnetwork B performs traffic unit replication sending one copy of the traffic unit to the downstream subnetwork C and another copy to the downstream subnetwork D via two different point-to-point MPLS-TP link connections. Subnetwork D will send the received traffic unit to its MPLS-TP TCP while subnetwork C performs traffic unit replication toward two MPLS-TP TCPs.

A unidirectional point-to-multipoint subnetwork connection broadcasts the traffic from the root MPLS-TP CP to the leaf MPLS-TP CPs as illustrated in [Figure 6-9](#)~~Figure 6-9~~. The broadcast function provided by the point-to-multipoint subnetwork connection is limited to the subnetwork in

which it exists. It may form part of a broadcast function within a larger (containing) subnetwork or network connection.

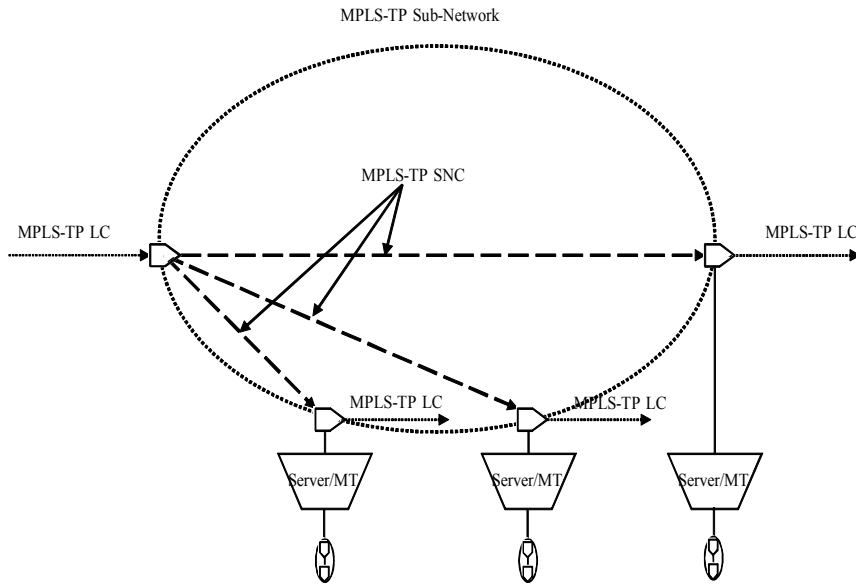

Figure 6-9 – Point-to-multipoint MPLS-TP subnetwork connection

Comment [IB9]: Figure updated per comment E12

A point-to-multipoint MPLS-TP network connection can be decomposed into point-to-multipoint MPLS-TP subnetworks connections and point-to-multipoint MPLS-TP link connections as shown in [Figure 6-10](#).

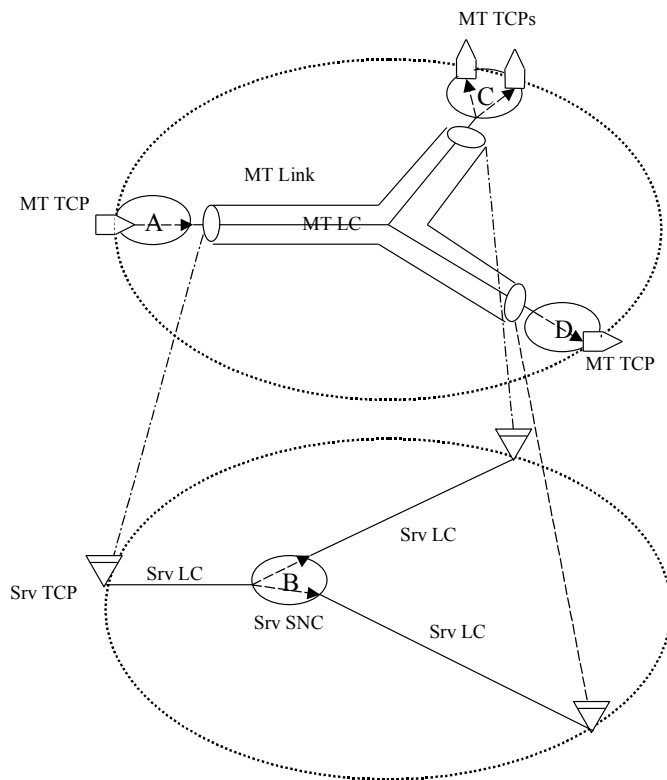

Figure 6-10 – MPLS-TP p2mp network connection using MPLS-TP p2mp link connection

Subnetwork A will send a single copy of the traffic units from the MT TCP to the downstream subnetworks C and D via a point-to-multipoint MPLS-TP LC.

The server layer supporting the point-to-multipoint MPLS-TP link can be any MPLS-TP server layer (as defined in clause [7.37.3](#) or another MPLS-TP server layer network instance). Server layer subnetwork B performs traffic unit replication in the server layer delivering one copy of the traffic unit to the downstream MPLS-TP subnetwork C and another copy to the downstream MPLS-TP subnetwork D.

Subnetwork D will send the received traffic unit to its MPLS-TP TCP while subnetwork C performs traffic unit replication toward two MPLS-TP TCPs.

When a point-to-multipoint Link is used, the link connection always matches the topology of the link. If the required connectivity is less than the one provided by the point-to-multipoint link, traffic units delivered at some of the link ends will be discarded by the Server/MT_A_Sk function. This could result in wasting of bandwidth resources on some links.

6.5 MPLS-TP Label Behaviour

The allocation of the label space is described in [IETF RFC 3031], [IETF RFC 3032], [IETF RFC 5331] and [IETF RFC 5332]. Per-platform, per-interface and context-specific label spaces are

supported by MPLS-TP as specified in [IETF RFC 5921] and [IETF RFC 5331]. The mechanisms for label allocation are outside the scope of this Recommendation.

6.5.1 MPLS Label values

[IETF RFC 3032] reserves the use of label values 0-15 for specific purposes. The reserved MPLS label values are managed by the Internet Assigned Numbers Authority (IANA) that will allocate MPLS Labels from the set of reserved Label values through the IETF consensus process.

Further information on the current registered MPLS Label values will be found in the IANA registries at [b-IANA Reg].

6.5.2 Label Manager

Each label space within an MPLS-TP Network Element (NE) is controlled by a single entity. This abstract entity is referred to as the label manager. The label manager is a location independent ~~logical~~abstract function component that is used to aid the description of the label allocation behaviour.

When an MPLS packet is received, its label is looked up in one particular label space as defined in clause 3.14 of [IETF RFC 3031].

The label manager is responsible for the allocation and reclamation of the labels that are used within MPLS. All MPLS applications (such as MPLS-TP) interface to this manager to obtain labels. The label manager coordinates the assignment of labels requested by the control plane and the management plane.

When a request is made to a label manager, a particular label value can be suggested. However there is no guarantee that the suggested label value would be allocated.

6.5.3 Labels for p2mp LSPs

[IETF RFC 5332] defines the meaning of a "multicast label" and the semantics to be associated to a set of "next hop label forwarding entry" (NHLFE) to which that multicast label is mapped. The architecture defined in this Recommendation is aligned with [IETF RFC 5332].

7 Server/client associations

Three forms of adaptation function are considered in this Recommendation:

- MT/client adaptation, where the client is not MPLS-TP.
- MT/MT adaptation, for supporting the mapping of PW over MPLS-TP LSPs as well as hierarchical MPLS-TP LSPs.
- Server/MT adaptation, where the server is not MPLS-TP.

Adaptation functions supporting hierarchical combinations of MPLS and MPLS-TP LSPs are for further study.

Formatted: Normal, Keep with next, Keep li together

7.1 MT/client adaptation

The MT/client adaptation (MT/Client_A) is considered to consist of two types of processes: client-specific processes and server-specific processes. The description of client-specific processes is outside the scope of this Recommendation.

7.1.1 MT/ETH adaptation

The encapsulation of Ethernet within MPLS-TP is defined in [IETF RFC 4448] and [IETF RFC 4720] and it is modelled in this clause. The raw mode is the default mode of encapsulation. The use

of the Control Word (CW) is as defined [IETF RFC 5586]. The use of the FCS retention is optional as defined in [IETF RFC 4720]. The model for the Native Service Processing (NSP) and the forwarder described in [b-IETF RFC 3985] is outside the scope of this Recommendation.

The bidirectional MT/ETH adaptation (MT/ETH_A) function is performed by a collocated pair of associated unidirectional MT/ETH adaptation source (MT/ETH_A_So) and sink (MT/ETH_A_Sk) functions. The description of the client-specific processes is outside the scope of this Recommendation.

The MT/ETH adaptation source (MT/ETH_A_So) performs the following server-specific processes between its input and output:

- Insert the Control Word (CW) as defined in [IETF RFC 4448]. The CW is also known as the common interworking indicators (CII) in [ITU-T Y.1415].
- Map the ETH_CI_P and ETH_CI_DE signals (as defined in [ITU-T G.8110]) into the MT_AI_PHB signal.
- Insert a one-bit S field (of the PW LSE) set to "1".
- Select the output MT_AP.
- Output the resulting MT_AI.

The MT/ETH adaptation sink (MT/ETH_A_Sk) performs the following server-specific processes between its input and output:

- Multiplex the MT_AI traffic units coming from all the MT_AP.
- Extract and process the one-bit S field.
- Map the MT_AI_PHB signal into the ETH_CI_P and ETH_CI_DE signals.
- Extract the Control Word (CW), and optionally process the sequence number field as defined in [IETF RFC 4448] and [ITU-T Y.1415].

Further definition of the MT/ETH function is outside the scope of this Recommendation and is described in [b-ITU-T G.8121].

<<NOTE TO TSB – If revised G.8121 (aligned with MPLS-TP) is not approved before the publication of this Recommendation, replace the text “and is described in [b-ITU-T G.8121]” with “and will be described in the MPLS-TP equipment Recommendations which are currently under development in ITU-T”>>

Formatted: Normal

Formatted: Highlight

Formatted: Highlight

Formatted: Highlight

Formatted: Highlight

Formatted: Highlight

Formatted: Highlight

7.2 MT/MT adaptation

The bidirectional MT/MT adaptation (MT/MT_A) function is performed by a collocated pair of associated unidirectional MT/MT adaptation source (MT/MT_A_So) and sink (MT/MT_A_Sk) functions.

Two associated unidirectional MPLS-TP (T)CPs that belongs to the same bidirectional LSP can have different labels associated with them.

The MT/MT adaptation source (MT/MT_A_So) performs the following processes between its input and its output.

- Forwarding or blocking client signal depending on the administrative state;
- Generation of OAM maintenance signals for Lock indication;

- Generate OAM signal to indicate the CI_APS information (for the case when the MT/MT is used within an Subnetwork Connection Protection (SNCP) with Sublayer monitoring (SNC/S) protection switching scheme);
- ~~Insert MCC and SCC packets from the MCN and SCN;~~
- Insert the same value 20-bit MPLS Label into each MT_CI traffic unit associated with a particular connection point;
- Insert TC field according to processes described in clause 1040;
- Multiplex the MPLS-TP Labelled frames;
- Insert a 1-bit S field set to 0.
- Select the output MT_AP.

The MT/MT adaptation sink (MT/MT_A_Sk) performs the following processes between its input and output.

- Multiplex the MT_AI traffic units coming from all the MT_APs.
- Extract and process the 1-bit S field;
- Demultiplex the MPLS labelled Packets using the 20-bit label value;
- Remove the 20-bit Label;
- Derives the CI_APS information from the OAM packets carrying it (for the case when the MT/MT is used within an SNC/S protection switching scheme);
- ~~Extract MCC and SCC packets and deliver them to the MCN and SCN;~~
- Process TC field according to clause 1040;
- Process TTL according to clause 1144. When the TTL is decremented and has expired, the traffic unit is processed locally and may be discarded;
- generation of OAM maintenance signals for alarm suppression;
- forwarding or blocking client signal depending on the administrative state;
- generation of OAM maintenance signals for Lock indication.

Further definition of the MT/MT function is outside the scope of this Recommendation and is described in [b-ITU-T G.8121]. Further details of the CI_APS will be provided in the Recommendations describing protection switching which are currently under development in ITU-T.

<<NOTE TO TSB – If revised G.8121 (aligned with MPLS-TP) is not approved before the publication of this Recommendation, replace the text “and is described in [b-ITU-T G.8121]” with “and will be described in the MPLS-TP equipment Recommendations which are currently under development in ITU-T”>>

Formatted: Font: 12 pt, (Asian) Japanese, (Other) English (U.K.)

Formatted: Normal

Formatted: Font: 12 pt, (Asian) Japanese, (Other) English (U.K.)

Formatted: Font: 12 pt, (Asian) Japanese, (Other) English (U.K.)

Formatted: Font: 12 pt, (Asian) Japanese, (Other) English (U.K.)

Formatted: English (U.K.)

7.3 Server/MT adaptation

MPLS-TP can be carried over different server layers as described in section 5 of [IETF RFC 5960].

The server/MT adaptation function described in this clause excludes the case where the server is MPLS.

This function is considered to consist of two types of processes: client-specific processes and server-specific processes. The client-specific processes are associated with the MT_CI traffic units, which ingress/egress via the MPLS-TP (T)CP. Server-specific processes are outside the scope of this Recommendation.

The bidirectional SrvServer/MT adaptation function is performed by a collocated pair of source and sink SrvServer/MT adaptation functions.

The Server/MT adaptation functions can work in two modes:

- mode 1: one or more MT connection points are allowed,
- mode 2 only a single MT connection point is allowed.

NOTE – The support of mode 1 is mandatory. Mode 2 supports MPLS-TP section monitoring and therefore it is optional.

Two associated unidirectional MPLS-TP (T)CPs that belongs to the same bidirectional LSP can have different labels associated with them.

For the case of mode 1, the SrvServer/MT adaptation source (SrvServer/MT_A_So) performs the following processes between its input and output.

- Forwarding or blocking client signal depending on the administrative state;
- Generation of OAM maintenance signals for Lock indication;
- Insert the same value 20-bit MPLS Label into each MT_CI traffic unit associated with a particular connection point;
- Insert TC field according to processes described in clause [1040](#);
- Multiplex the MPLS-TP Labelled frames.
- Server layer related specific processes

For the case of mode 1, the SrvServer/MT adaptation sink (SrvServer/MT_A_Sk) performs the following processes between its input and output:

- Server layer related specific processes
- Demultiplex the MPLS labelled Packets using the 20-bit label value;
- Remove the 20-bit Label;
- Process TC field according to clause [1040](#);
- Process TTL according to clause [1144](#). When the TTL is decremented and has expired, the traffic unit is processed locally and may be discarded.
- generation of OAM maintenance signals for alarm suppression
- forwarding or blocking client signal depending on the administrative state;
- generation of OAM maintenance signals for Lock indication.

For the case of mode 2, the SrvServer/MT adaptation source (SrvServer/MT_A_So) performs the following processes between its input and output.

- Forwarding or blocking client signal depending on the administrative state;
- Generation of OAM maintenance signals for Lock indication;
- Remove the TTL and S fields.⁴
- Server layer related specific processes

⁴ Note that the description for the mode 2 includes the removal and replacement of the TTL and S fields. This is an artifact of the model and has no implication from an implementation point of view.

For the case of mode 2, the ~~Server~~Server/MT adaptation sink (~~Server~~Server/MT_A_Sk) performs the following processes between its input and output:

- Server layer related specific processes
- Insert a TTL field equal to 254 and the S bit equal to 0. ⁵
- generation of OAM maintenance signals for alarm suppression
- forwarding or blocking client signal depending on the administrative state;
- generation of OAM maintenance signals for Lock indication.

Further definition of the ~~processes to adapt MPLS-TP to server layers~~Server/MT functions is outside the scope of this Recommendation and ~~will be is~~ described in [b-ITU-T G.8121].

~~<<NOTE TO TSB – If revised G.8121 (aligned with MPLS-TP) is not approved before the publication of this Recommendation, replace the text “and is described in [b-ITU-T G.8121]” with “and will be described in the MPLS-TP equipment Recommendations which are currently under development in ITU-T”>>~~

Formatted: Normal, Tab stops: Not at 9.98

Formatted: Font: Not Italic, Complex Script
Font: Not Italic, English (U.K.)

If the server layer is Ethernet, a mechanism should be provided to enable the correct setting of the MAC destination address.

8 MPLS-TP OAM Architecture

This clause describes the OAM functionality needed for MPLS-TP network architecture in single or multi-domain scenarios.

The MPLS-TP OAM Requirements are defined in [IETF RFC 5860].

The MPLS-TP OAM Architecture and Framework are defined in [IETF RFC 6371 ~~tp-oam-fw~~].

~~NOTE – The definition of MPLS-TP OAM mechanisms is outside the scope of this Recommendation and is defined in [ITU-T G.8113.1] and [ITU-T G.8113.2]; the MPLS-TP OAM implementations are described in [b-ITU-T G.8121], [b-ITU-T G.8121.1] and [b-ITU-T G.8121.1].~~

Formatted: Note

~~<<NOTE TO TSB – If revised G.8121 (aligned with MPLS-TP) is not approved before the publication of this Recommendation, replace the text “are described in [b-ITU-T G.8121], [b-ITU-T G.8121.1] and [b-ITU-T G.8121.1]” with “and will be described in the MPLS-TP equipment Recommendations which are currently under development in ITU-T”>>~~

Formatted: Highlight

The MPLS-TP OAM mechanisms and implementation are outside the scope of this Recommendation.

8.1 General

8.1.1 Management and Control communications

The MPLS-TP layer network supports Embedded Communication Channels (ECCs) between NEs to support management and control communications (MCC and SCC) as described in [ITU-T G.7712] and [IETF RFC 5718].

These forms of communication may also be supported externally to the MPLS-TP layer network.

⁵ Note that the description for the mode 2 includes the removal and replacement of the TTL and S fields. This is an artifact of the model and has no implication from an implementation point of view.

Within the MPLS-TP layer network the Embedded Communication Channels (ECC) is provided using the Generic Associated Channel defined in [IETF RFC 5586], as described in [IETF RFC 5718].

8.1.2 Server/client interaction

To avoid unnecessary, inefficient or conflicting survivability actions, escalation strategies are required as described in Requirement 61 of [IETF RFC 5654].

To avoid alarm storms in case of server layer failures, alarm suppression capabilities are required as described in section 2.2.8 of [IETF RFC 5860].

8.1.3 MPLS-TP maintenance entity groups

MPLS-TP OAM operates in the context of Maintenance Entity Groups (MEGs) that are defined in [IETF RFC 6371~~tp-oam-fw~~]. The ~~structure information content~~structure of the identifiers for the MEG, MEP and MIP ~~using the IP based global ID is are~~ defined in [IETF RFC 6370~~tp-ident~~]; the ~~structure of the identifiers using the ICC is defined in [ITU-T G.8113.1] for further study.~~

Formatted: Not Highlight

Formatted: Not Highlight

NOTE – The information content of the identifiers for the MEG, MEP and MIP is defined in [IETF RFC 6370] which specifies the use of the IP based Global ID to uniquely identify a network operator. An alternative way to uniquely identify a network operator using a combination of the Country Code (CC), as defined in [ITU-T G.8013] and the ITU carrier code (ICC), as defined in [ITU-T M.1400], will be defined in [b-IETF tp-itu-id].

MPLS-TP OAM supports a single maintenance entity group (MEG) for network connection monitoring, an arbitrary number of maintenance entity groups (MEGs) for tandem connection monitoring and one maintenance entity group (MEG) for link connection monitoring.

NOTE – This Recommendation models SPME with 1:1 association (in order to implement tandem connection monitoring). SPMEs with 1:n association are not precluded but their model is for further study.

The maintenance entity for network connection monitoring monitors the MPLS-TP network connection between a pair of termination connection points at the boundary of the MPLS-TP layer network (see ~~Figure 6-4~~Figure 6-4).

The maintenance entity for tandem connection monitoring monitors the MPLS-TP tandem connection between any arbitrary pair of MPLS-TP connection points.

Multiple MEG levels are provided by means of label stacking as defined in [IETF RFC 6371~~tp-oam-fw~~].

MEGs can be used when the MPLS-TP layer network contains multiple administrative domains: e.g., service provider and one or more network operator domains. In this case, the interconnection between two administrative domains is always done via an MPLS-TP link connection.

Each of these administrative domains has an associated maintenance entity group located between a pair of MPLS-TP connection points at the boundaries of that MPLS-TP layer network administrative domain. Maintenance entity groups also exist between a pair of MPLS-TP connection points at the boundary of two adjacent MPLS-TP layer network administrative domains.

~~Figure 8-1~~Figure 8-1 and ~~Figure 8-2~~Figure 8-2 illustrate such MPLS-TP layer network administrative domain maintenance entity groups for the point-to-point and point-to-multipoint connection cases.

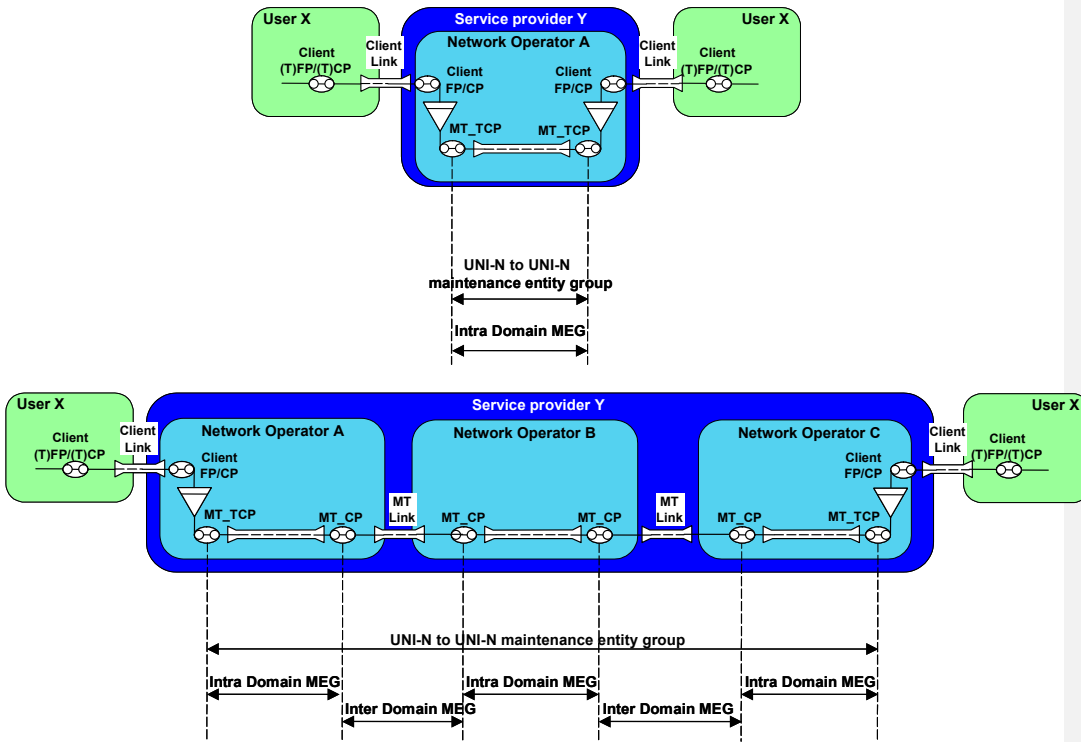

Figure 8-1 – Point-to-point MPLS-TP connection administrative domain associated maintenance entity groups

Comment [F810]: Figure updated

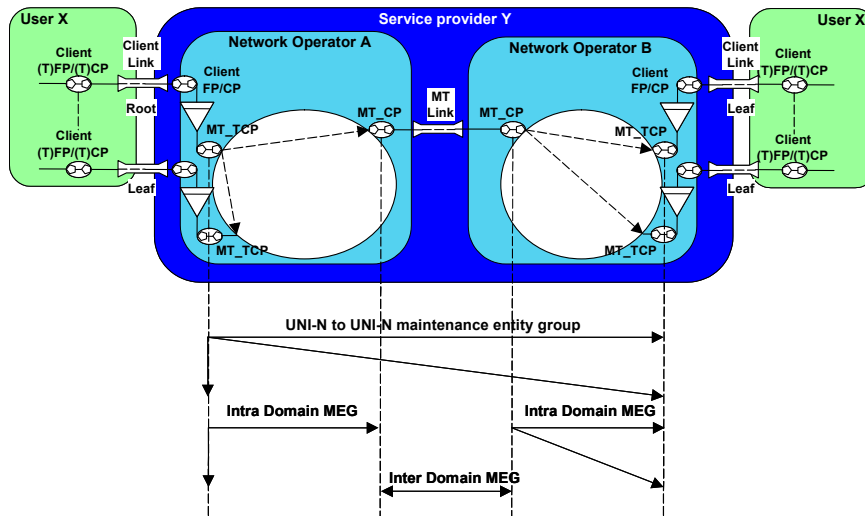

Figure 8-2 – Point-to-multipoint MPLS-TP connection administrative domain associated maintenance entity groups

Comment [F811]: Figure updated

MEGs can be used for operating protection switching or restoration applications as well as testing applications. Such maintenance entity groups can be between any two MPLS-TP connection points in the MPLS-TP layer network.

8.2 MPLS-TP connection and trail supervision

Connection supervision is the process of monitoring the integrity of a given maintenance entity group in the MPLS-TP layer network. The integrity may be verified by means of detecting and reporting continuity, connectivity and transmission performance defects for a given maintenance entity group. [ITU-T G.805] defines trail monitoring and four types of connection monitoring techniques for maintenance entity groups.

The maintenance entity group supervision process can be applied to network connections or tandem connections (an arbitrary series of subnetwork connections and link connections).

8.2.1 Inherent monitoring

MPLS-TP maintenance entity groups may be indirectly monitored by using the inherently available data from the server layers and computing the approximate state of the client connection from the available data.

MPLS-TP layer network maintenance entity groups may be indirectly monitored by using the inherently available data from the MPLS-TP server layers (e.g., SDH Virtual Container (VC), Optical Transport Hierarchy (OTH) Optical channel data unit (ODU), MPLS-TP server trail) and computing the approximate state of the MPLS-TP maintenance entity group from the available data.

8.2.2 Non-intrusive monitoring

This section is for further study.

8.2.3 Intrusive monitoring

For the diagnostic tests of certain parameters (e.g., throughput), an intrusive measurement has to be performed that interrupts the user data traffic in the diagnosed entity. The diagnostic tests can be performed as uni- or bidirectional diagnostic tests. In case of unidirectional tests, the user data

traffic in one direction is interrupted. In case of bidirectional tests, the user data traffic in both directions is interrupted. An OAM signal that carries the Lock indication is inserted for the immediate client ME at the egress of the interrupted entity.

This technique is restricted to the set-up, or intermittent testing.

8.2.4 Trail monitoring

The MT_TT adds OAM to the adapted information such that the network connection's maintenance entity group can be directly monitored by the MPLS-TP trail created in the MPLS-TP layer network. With this technique, all parameters can be tested directly.

MPLS-TP layer network maintenance entity groups may be directly monitored by means of insertion of connection monitoring OAM at the ingress of the MPLS-TP trail and extraction and processing of this OAM at the egress of the MPLS-TP trail.

MPLS-TP LSP network connections are monitored by inserting OAM packets using the Generic Associated Channel (G-ACh) Label (GAL) and the ACH as defined in [IETF RFC 5586].

MPLS-TP PW network connections are monitored by inserting OAM packets using the ACH as defined in [IETF RFC 5586] and [IETF RFC 4385].

Insertion, extraction and processing of this connection monitoring OAM is functionally performed in MPLS-TP trail termination functions MT_TT, which establish MPLS-TP connection-oriented trails.

NOTE – MPLS-TP OAM requirements are defined in [IETF RFC 5860]. MPLS-TP OAM mechanisms are outside the scope of this Recommendation.

8.2.4.1 MPLS Interoperability considerations

Within an MPLS-TP network, the PWE3 control word [IETF RFC 4385] is used to realize the associated control channel to carry PW OAM. This mechanism can be also used in existing MPLS deployments.

However, existing deployments may not support the CW or the ACH. Therefore other methods of PW OAM (e.g., VCCV types 2 and 3) that do not use the control word are used.

A detailed description of the interoperability is for further study.

8.2.5 Sublayer monitoring

Additional OAM and trail overhead is added to the original characteristic information such that the maintenance entity group of interest can be directly monitored by a trail created in a sub-layer. With this technique, all parameters can be tested directly. This scheme can provide for nested sub-layer trail monitored maintenance entity groups.

Tandem connection monitoring (TCM) for a segment of a given LSP is implemented by creating an SPME which spans the corresponding segment of the network and supports only the original LSP over this network segment as a client. This new SPME thus exists at the server sub-layer with respect to the original LSP

As described in [IETF RFC 6371 [ip-opts-14](#)], the DiffServ uniform model for TC processing (see section [10.2.4.2](#)) is used to preserve the QoS information of the end-to-end MPLS-TP connection. Note that the short-pipe model for TTL handling is used to support the delivery of OAM packets to MIPs, based on TTL expiration, as defined in [IETF RFC 6371 [ip-opts-14](#)].

NOTE – Using different models for DiffServ and TTL processing on an SPME, for other than TCM purposes, as defined in [IETF RFC 6371 [ip-opts-14](#)] is not precluded.

The server sub-layer LSP is monitoring using normal LSP monitoring as defined above in clause 8.2.48-2.4. The server sub-layer LSP is viewed as a single hop by the client LSP.

Figure 8-3 below describes an example of TCM setup between nodes B and D to monitor a segment of an end-to-end LSP from node A to node D.

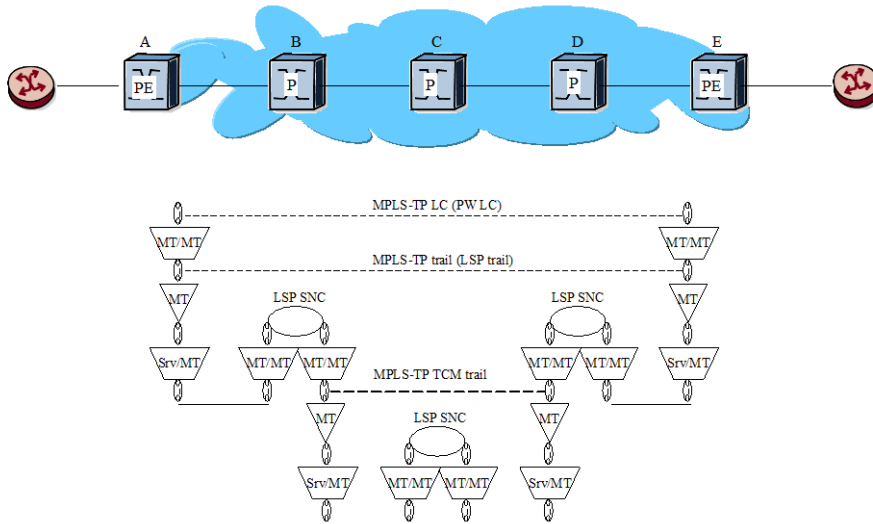

Figure 8-3 – MPLS-TP TCM Example

MPLS-TP LSP tandem connections are monitored by inserting G-ACh packets using the GAL and the ACh as defined in [IETF RFC 5586] within the sub-layer.

MPLS-TP PW tandem connection monitoring is outside the scope of this version of the Recommendation.

8.3 MPLS-TP Maintenance Entity Group monitoring

8.3.1 Pro-active monitoring

MPLS-TP maintenance entity groups may be pro-actively monitored by means of continuous insertion of MPLS-TP OAM at the ingress of the MPLS-TP maintenance entity group and extraction and processing of this MPLS-TP OAM at the egress of the MPLS-TP maintenance entity group.

Insertion and extraction of pro-active OAM is performed by the MT_TT atomic function (see section 6.2.3.16-2.3-1).

8.3.2 On-demand monitoring

On-demand MPLS-TP MEG monitoring application complements the pro-active MPLS-TP monitoring application. On-demand MPLS-TP MEG monitoring application provides performance characterization and fault localization capabilities. The latter allow for discovering the node in which a MPLS-TP continuity or connectivity fault is located.

On-demand MPLS-TP OAM can be inserted at the ingress of the MPLS-TP maintenance entity, which is then replied to from intermediate and/or egress points of the MPLS-TP maintenance entity

group.

Insertion of on-demand OAM is done by the MT_TT atomic function. Extraction and reply to on-demand OAM is done by:

- the MT_TT atomic function (see section [6.2.3.16.2.3.4](#)) in egress points of the MPLS-TP maintenance entity
- the MIP functional component (see section [8.48.4](#)) in the intermediate points of the MPLS-TP maintenance entity

8.4 MPLS-TP MIP

In order to model a per-interface MIP, as defined in [IETF [RFC 6371](#) [ip-sam-34](#)], the MPLS-TP MIP functional component is defined to be able to respond to on-demand MPLS-TP OAM signals received from both directions ([Figure 8-4](#)[Figure 8-4](#)).

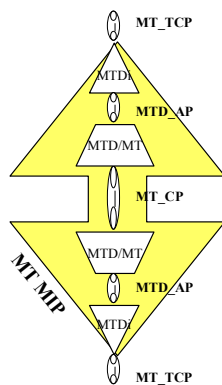

Figure 8-4 – MPLS-TP MIP compound function

In order to model a per-node MIP, as defined in [IETF [RFC 6371](#) [ip-sam-34](#)], a variant of the MPLS-TP MIP functional component is the half MIP (MTDi) that is able to respond to on-demand MPLS-TP OAM signals received only from one direction ([Figure 8-5](#)[Figure 8-5](#)).

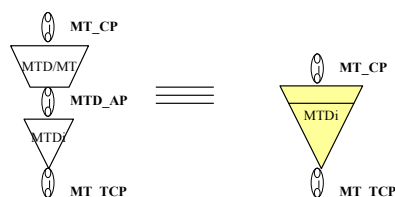

Figure 8-5 – MPLS-TP half MIP compound function

8.5 Bandwidth considerations with MPLS-TP OAM

The following considerations must be taken into account when planning the server layer capacity in networks where MPLS-TP OAM is activated:

- The GAL and ACH allow additional traffic, such as OAM or MCC/SCC, to be added to the existing client traffic. Bandwidth allocation must consider both on-demand and pro-active OAM traffic.

NOTE – When MCC/SCC is used; the required additional bandwidth is higher than the OAM.

- In setup of MPLS-TP LSP tandem connection (see [8.2.58-2.5](#)), the label identifying tandem connection is attached for the all the MPLS-TP packets transiting the TCM, i.e. between B and D in [Figure 8-3](#), this increases the bandwidth consumed by the traffic.

9 MPLS-TP survivability techniques

Requirements for MPLS-TP Survivability are defined in section 2.5 of [IETF RFC 5654].

MPLS-TP Survivability Architecture and Framework are described in [b-IETF [RFC 6372](#)]].

Restoration can be performed by a Network Management System (NMS) system or by a control plane as defined in [ITU-T G.8080] and described in [b-IETF [RFC 6372](#)]].

10 MPLS-TP Diff-Serv Architecture

Both E-LSP and L-LSP, as defined in [IETF RFC 3270] and [IETF RFC 5462], are supported by MPLS-TP.

NOTE - The MPLS-TP architecture also supports the data plane for DiffServ-TE, as defined in [b-IETF RFC 4124]. The TC processing for Diff-Serv and DiffServ-TE is the same. The data planes of Diff-Serv and of the variants of DiffServ-TE differ in the implementation of the queuing process within the Server/MT_A functions. These details are outside the scope of this Recommendation.

The setting of the traffic class (TC) field is as defined in [IETF RFC 3270] and [IETF RFC 5462] for the short-pipe and uniform models with no Penultimate Hop Popping (PHP).

~~The TC behaviour of these tunnelling models for the short-pipe and uniform models with no Penultimate Hop Popping (PHP) is provided in this clause by means of diagrams that describe the TC processing that occurs in each of the transport processing functions in the appropriate reference diagram. The TC behaviour description for other modes of operation is not described in this version of the Recommendation.~~

~~The MT/Client A So, for non MPLS-TP client layers as defined in clause 7.17.4, selects the AI_PHB to be applied by the MPLS-TP layer network using the QoS information in the client CI. The selection is client-specific and outside the scope of this Recommendation. The MT/Client A Sk, for non MPLS-TP client layers as defined in clause 7.17.4, would generate the proper QoS information in the client CI based on the AI_PHB. The generation of QoS information in the client layer network is client-specific and outside the scope of this Recommendation.~~

In order to support short-pipe and uniform tunnelling modes, as defined in [IETF RFC 3270], the ~~tunnelling mode is configured for each MT_CP of the Server/MT/MT_A So function is configured, on individual MT_CP basis, to encode the TC field based on one of the following QoS Encoding Modes:~~

- ~~QoS Encoding Mode A where the TC field is encoded according to the outgoing PHB information. When the short-pipe tunnelling mode is configured, the AI_PHB to be applied by the server MPLS-TP sub-layer network is selected using the CI_oPHB;~~

- ~~QoS Encoding Mode B where the TC field is encoded with any value. When the uniform tunnelling mode is configured, the AI_PHB is generated to be identical to the CI_oPHB (representing non-meaningful Diff-Serv information).~~

~~Section 2.6.3 of [IETF RFC 3270] states that when the uniform model is used the TC field in the encapsulated label stack entry is "of no importance". [IETF RFC 5462] specifies that the TC field must not be used for other purposes than QoS encoding.~~

~~Regardless of the configured tunnelling mode, the MT/MT_A_So function encodes the TC field according to the CI_oPHB information.~~

~~The tunnelling mode is also configured for each MT_CP of the Server/MT/MT_A_Sk function is also configured, on individual MT_CP basis, to decode the TC field based on one of the following QoS-Decoding Modes:~~

- ~~QoS-Decoding Mode A where the outgoing PHB. When the short-pipe tunnelling mode is configured, the CI_iPHB is determined by looking at the TC field;~~
- ~~QoS-Decoding Mode B where. When the uniform tunnelling model is configured, the TC field is ignored and the outgoing PHB. CI_iPHB is received from the MT_AP generated to be identical to the AI_PHB (because it is determined by looking at the TC field of a server level MPLS label stack entry).~~

~~Details on how the QoS-Encoding Mode and QoS-Decoding Mode are used to supported short-pipe and uniform MPLS-TP tunnelling modes are described modelled are provided in the following clauses 10.1+0.1 and 10.2+0.2.~~

~~The Server/MT_A_So, for non MPLS-TP server layers as defined in clause 7.37.3, always encodes the TC field according to the CI_oPHB information. The Server/MT_A_Sk, for non MPLS-TP server layers as defined in clause 7.37.3, always determines the CI_iPHB by looking at the TC field.~~

~~The MT/Client_A_So function in Figure 10-1 selects the AI_PHB in the MPLS-TP layer network using the Diff-Serv information in the client_CI. The selection is client-specific.~~

10.1 Short-Pipe Model

The transport processing functions and processes for the short-pipe model (without penultimate hop popping) are described in ~~Figure 10-1~~ ~~Figure 10-1~~.

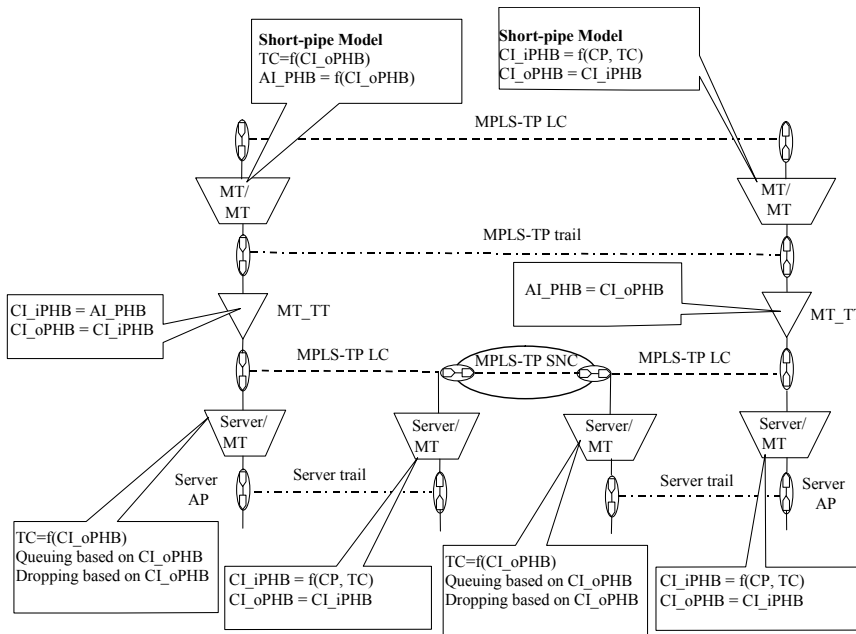

Figure 10-1 – Reference diagram for the short-pipe model

NOTE – The ~~Server and Client~~ layers in ~~Figure 10-1~~ ~~Figure 10-1~~ are assumed to be ~~can be~~ ~~MPLS-TP~~ or non-MPLS-TP layers. ~~The non-MPLS-TP client layers are defined in clause 7.1; the non-MPLS-TP server layers are~~, as defined in clause 7.37.3. When the server layer is an MPLS-TP LSP, the behaviour depends on the tunnel mode.

10.2 Uniform Model

The transport processing functions and processes for the uniform model (without penultimate hop popping) are described in ~~Figure 10-2~~ ~~Figure 10-2~~.

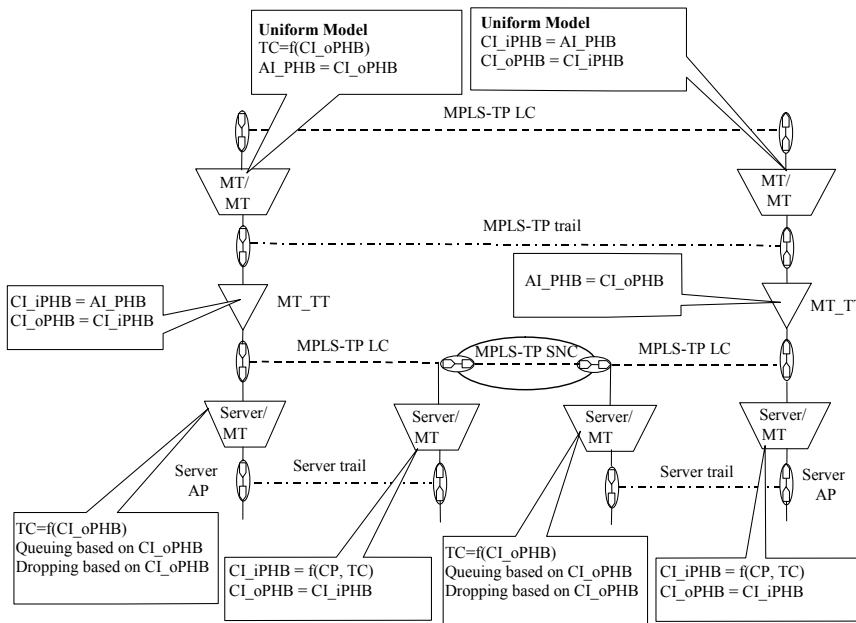

Figure 10-2 – Reference diagram for the uniform model

NOTE – The Server layers in ~~Figure 10-2~~ ~~Figure 10-2~~ can be MPLS-TP or are assumed to be non MPLS-TP layers. ~~The non MPLS-TP server layers are, as~~ defined in clause 7.37.3. When the server layer is an MPLS-TP LSP, the behaviour depends on the tunnel mode.

11 MPLS-TP TTL Behaviour

The setting of the time-to-live (TTL) field for data traffic is as defined in [IETF RFC 3443] ~~for the short-pipe models with no PHP.~~ This Recommendation describes the TTL field setting for the short-pipe models with no PHP. The setting of the TTL field for other modes of operation is not described in this version of the Recommendation.

The setting of the time-to-live (TTL) field for the OAM traffic is as defined in [IETF RFC 5586] and [IETF RFC 6371].

Intermediate nodes decrement the TTL field as defined in [IETF RFC 3031] and [IETF RFC 3443].

If the TTL has expired, the packet is checked to see if it is an OAM packet. OAM packets are processed locally. All other packets with TTL expired are processed as defined in section 2.4 of [IETF RFC 3032].

12 Security aspects

The security considerations applicable to both MPLS and PWE3 apply to MPLS-TP as described in [IETF RFC 5921] and [IETF RFC 6371].

Further security considerations are under development in IETF.

Annex A

Default configuration options for MPLS-TP in Packet a Transport Network (PTN) Applications

(This annex forms an integral part of this Recommendation)

This annex provides options and configurations of MPLS-TP ~~in a PTN application.~~

- 1) ~~This application is intended to include the deployment of multi technology transport nodes that may include MPLS-TP, Ethernet, OTN and SDH transport technologies.~~
- 2) ~~Multiple transport layers may be supported by a common node.~~
- 3) ~~In a network where the primary requirements are driven by a desire for consistency from the perspective of Transport Network (SDH/OTN) operational behaviour, operational functionality and operational process.
 - a. ~~In particular compatibility with the existing OAM and protection switching paradigm for SDH, OTN, Ethernet. i.e. provide the same controls and indications.~~
 - b. ~~Compatibility (consistency) means that the same management information model is used. This enables upgrades of the OSS infra-structure in which it is only necessary to recognize the new type of layer network technology.~~
 - c. ~~Minimize the impact on the workforce that operates the existing transport network. e.g. retraining about the same as for SDH to OTN.~~~~
- 4) ~~[ITU-T G.7710], [ITU-T G.806], [ITU-T G.808.1] and [b ITU-T G.808.2] describe the common behaviour (also see [b IETF RFC 5951] for [ITU-T G.7710])~~
- 5) ~~Transport Network: A connection oriented network who's connections provides connectivity between service switches.~~
- 6) ~~Currently connections are limited to point to point co-routed bidirectional transport path.
 - a. ~~Future requirement to support uni-directional point to multipoint.~~~~
- 7) ~~Independence between services and transport i.e. the transport network is service agnostic
 - a. ~~Provides a transport path for a PW or a LSP~~~~

~~Interconnection scenarios are defined in Annex BB.~~

~~Deployment of MPLS-TP in PTN applications allow consistent operations that result in operational behaviour that is consistent with other transport technologies defined by the ITU-T. MPLS-TP is a Connection-Oriented Packet Switched (CO-PS) technology and therefore can be modelled by using [ITU-T G.805].~~

Equal Cost Multi-Path (ECMP) is not used with point-to-point and point-to-multipoint LSPs as described in [IETF RFC 5960].

A summary of the key default modes of operations described by this ITU-T Recommendation is:

- MPLS-TP connections are supported by traffic-engineered connections in the server layer to guarantee that the traffic loading imposed by other clients does not cause the transport service provided to the MPLS-TP layer to fall bellow-below the agreed level (see Requirement 32A [IETF RFC 5654]).

Formatted: Bullets and Numbering

- Multi-link considerations described in [IETF RFC 6371 ~~ip-nam-fw~~] are not applicable.
- For MPLS-TP LSPs, PHP is disabled by default and this is the preferred mode of operation.
- Unidirectional or co-routed bidirectional point-to-point LSPs, as defined in [IETF RFC 5654] are supported. Co-routed bidirectional LSPs are defined by pairing the forward and backward directions to follow the same path (i.e., the same nodes and links). The pairing relationship between the forward and the backward directions is known in each node traversed by the bidirectional LSP.
- Unidirectional point-to-multipoint LSPs are supported, as defined in [IETF RFC 5654].
- The ITU-T format option for transport entities and OAM entities identifiers, ~~as defined in [IETF ip-identITU-T-G.8113.1]~~, is selected.
- Transport LSPs, as defined in [IETF RFC 5921], use the short-pipe model without PHP for TC processing, according to [IETF RFC 3270] and [IETF RFC 5462].
- In order to support tandem connection monitoring (as per section ~~8.2.58.2.5~~), SPMEs, as defined in in [IETF RFC 5921], use the uniform model without PHP for TC processing, according to [IETF RFC 3270] and [IETF RFC 5462].
- TC processing according to the short-pipe model without PHP according to [IETF RFC 3443].
- Both E-LSP and L-LSP are supported as defined in [IETF RFC 3270] and [IETF RFC 5462].
- In applications where the LSP has adequate bandwidth to carry its clients without dropping packets, only a single drop precedence is needed. In applications that use statistical multiplexing gain, more than one drop precedence may be used.
- Per-platform, per-interface and context-specific label spaces are supported as specified in [IETF RFC 5921] and [IETF RFC 5332].
- Multipoint-to-point and multipoint-to-multipoint LSPs are not supported.
- Non MPLS-TP Server layer networks are configured not to cause reordering of packets sent over an MPLS-TP connection (PW or LSP) in normal operations.
- The data plane (forwarding plane, OAM and resiliency) is operated and configured without any IP forwarding capability in the data plane as per requirement 36 of [IETF RFC 5654].
- The data plane (forwarding plane, OAM and resiliency) is logically and/or physically separated from the control and management plane as per requirements 15 and 16 of [IETF RFC 5654].

Formatted: Not Highlight

Annex B

- ~~Interconnection of PTN and PSN networks a domain using the OAM tools defined in G.8113.1 and a domain using the OAM tools defined in G.8113.2~~
- ~~(This annex forms an integral part of this Recommendation)~~
- ~~[Editor's note - The text changes in this Annex are pending agreement on C1821 and C1822]~~
- ~~[Editor's note - Take a final look at Annex B to check that there are no inconsistencies]~~
- ~~To simplify the figures describing the scenarios the following abbreviations are used in this annex:~~
- ~~O2D: A domain in which the default OAM tools defined in [ITU T G.8113.2] are used~~
- ~~O1D: A domain in which the optional OAM tools defined in [ITU T G.8113.1] are used.~~
- ~~O2T: Default OAM tools defined in [ITU T G.8113.2]~~
- ~~O1T: Optional OAM tools defined in [ITU T G.8113.1]~~
- ~~Three scenarios for interconnection are described below:~~

Formatted: Bullets and Numbering

Formatted: Font: Italic, Highlight

Formatted: enumlev1

Formatted: Font: Italic, Highlight

Formatted: Font: Italic

Formatted: Font: Italic, Highlight

Formatted: Font: Italic

Formatted: Highlight

Formatted: Highlight

Formatted: Highlight

Formatted: Highlight

B.1 PTN client over a PSN server Client that uses the G.8113.1 OAM tools over a server that uses the G.8113.2 OAM tools

In this case a LSP originates and terminates in a domain using the optional OAM tools defined in [ITU-T G.8113.1] (O1D) PTN network and crosses a domain using the default OAM tools defined in [ITU-T G.8113.2] (O2D) PSN network. The end to end PTN LSP uses the optional OAM tools (O1T) and runs as a client over the domain using the default OAM tools defined in [ITU-T G.8113.2] (O2D) PSN network. This is illustrated in figure B.1 below.

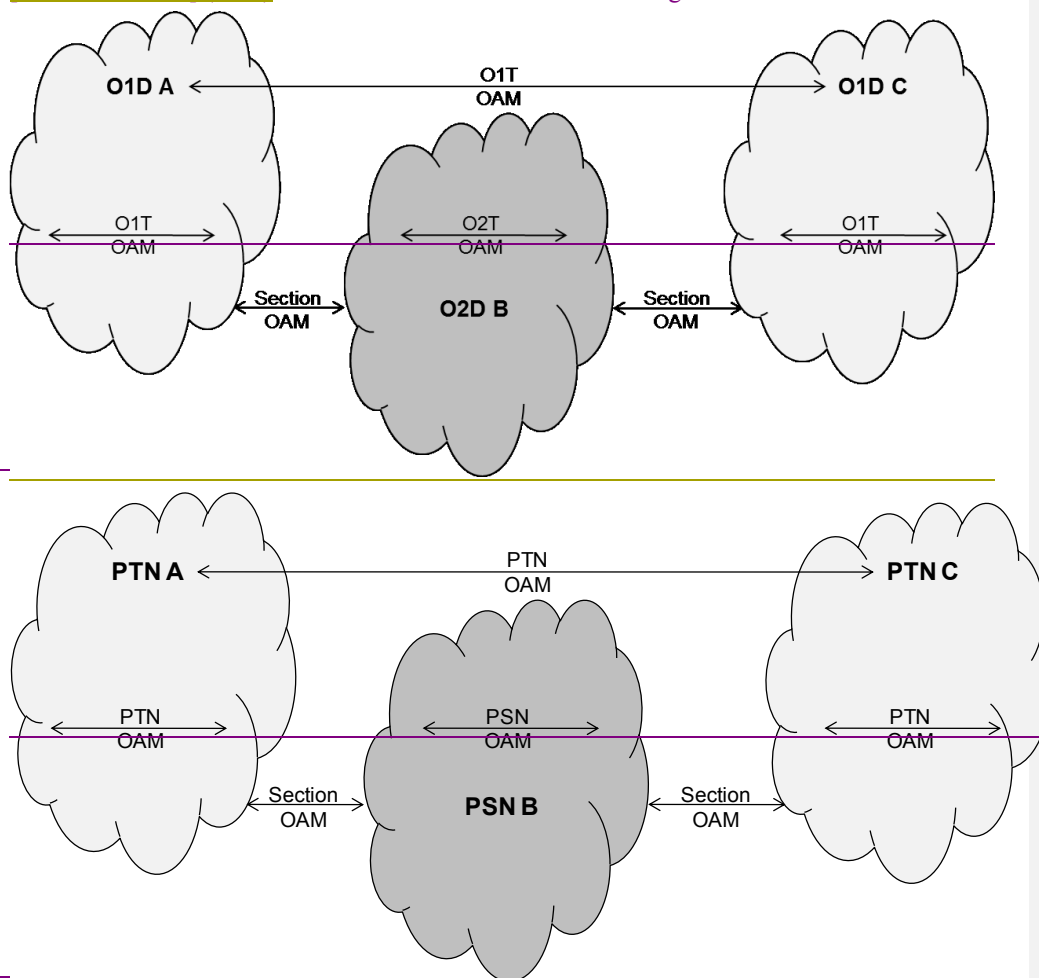

Figure B.1 Interconnection case 1) PTN O1T client over a PSN O2T server

Further details of this are provide in figure B.2 below:

Formatted: Highlight

Formatted: Highlight

Formatted: Highlight

Formatted: Highlight

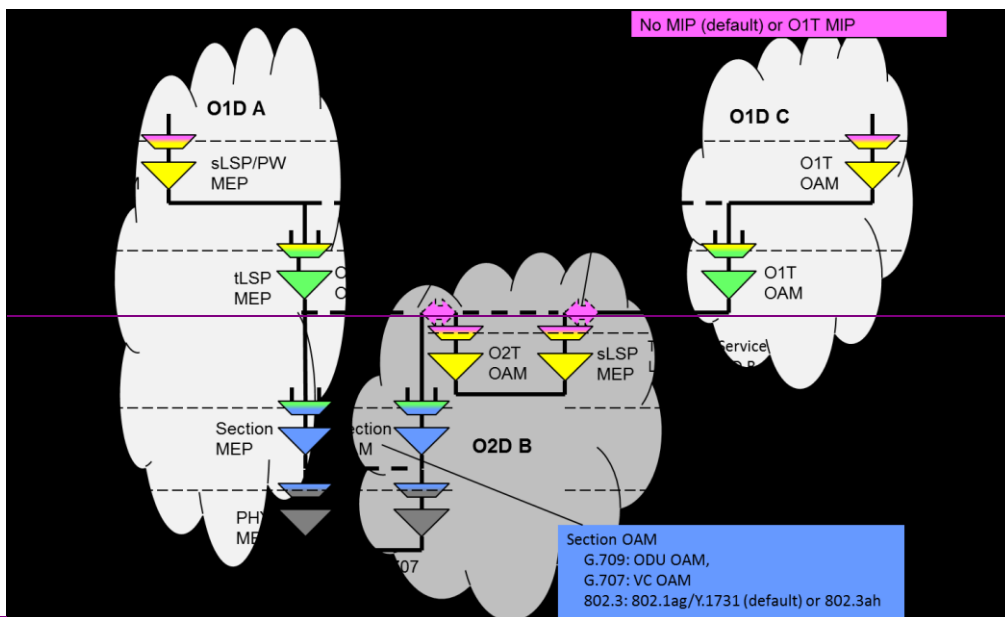

Formatted: enumlev1

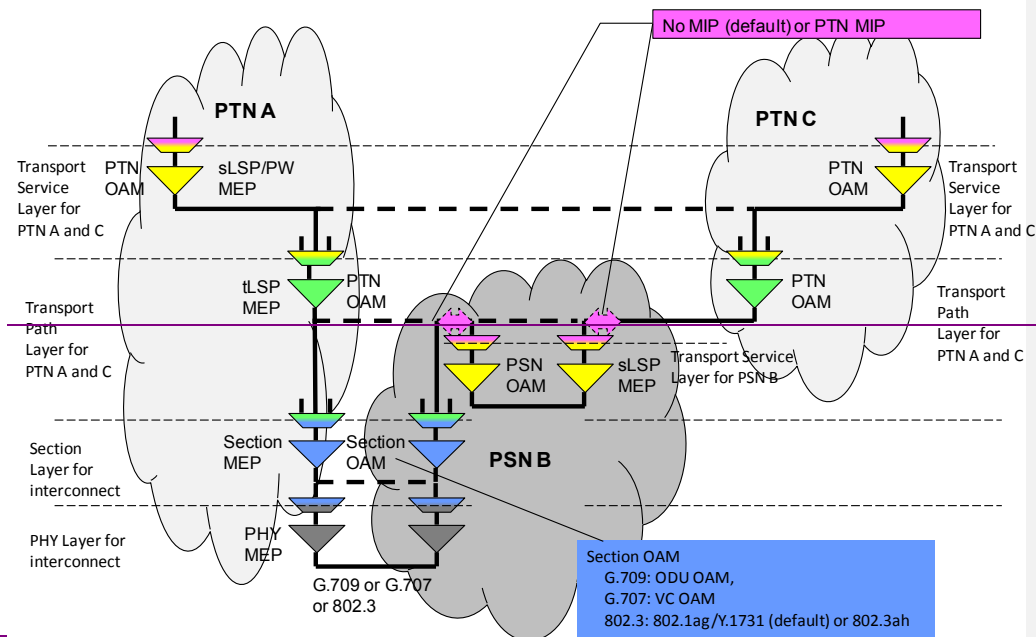

Formatted: Highlight

Formatted: Highlight

Formatted: Highlight

- **Figure B.2 Interconnection case 1) PTN O1T client over a PSN O2T server**
- Support of a PTNan O1T MIP within the PSN network O2D is optional.
- **B.2 PSN client over a PTN server** Client that uses the default G.8113.2 OAM tools over a server that uses the G.8113.1 OAM tools
- In this case a LSP originates and terminates in a domain using the default tool set (O2D) PSN network and crosses a domain using the optional tool set (O1D) PTN network. The end to end

PSN LSP uses the default OAM tools (O2T) and runs as a client over the domain using the optional tool set (O1D)PTN network. This is illustrated in figure B.3 below.

Formatted: Highlight

Formatted: Highlight

Formatted: enumlev1

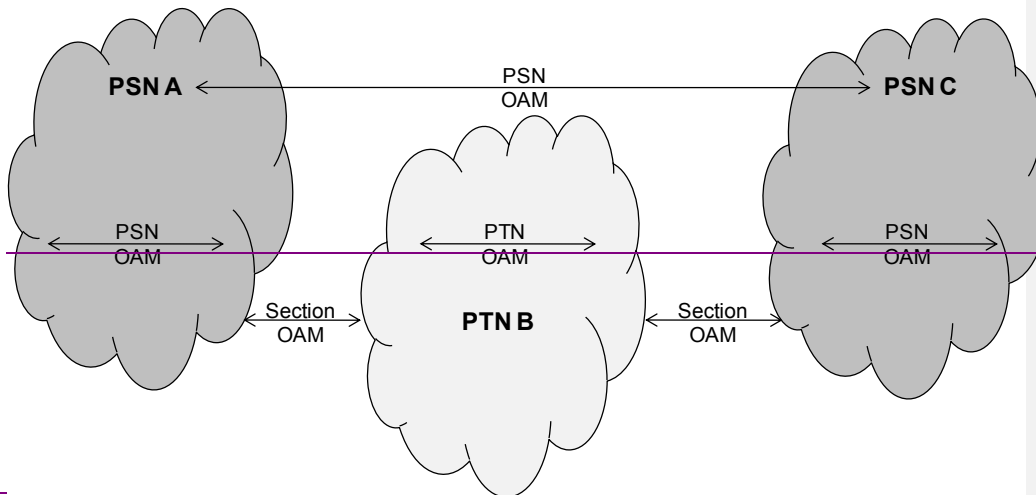
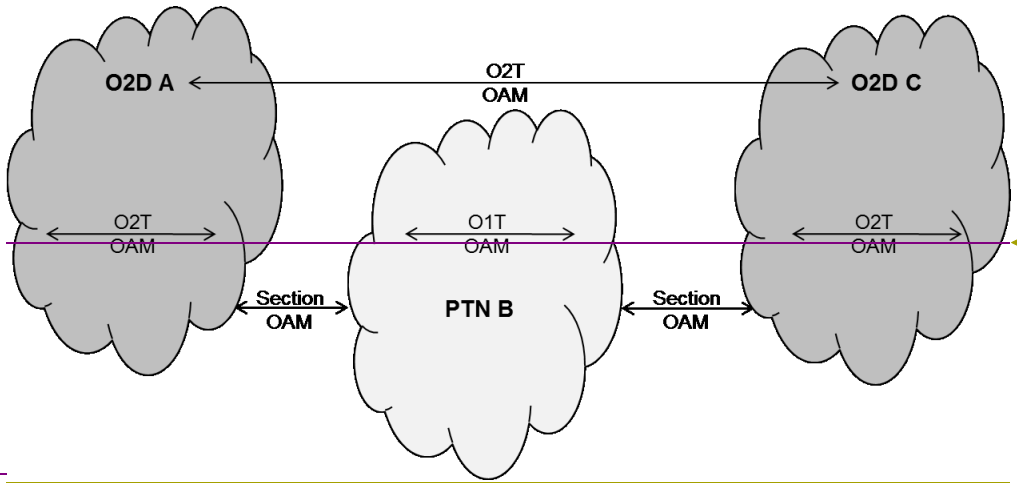
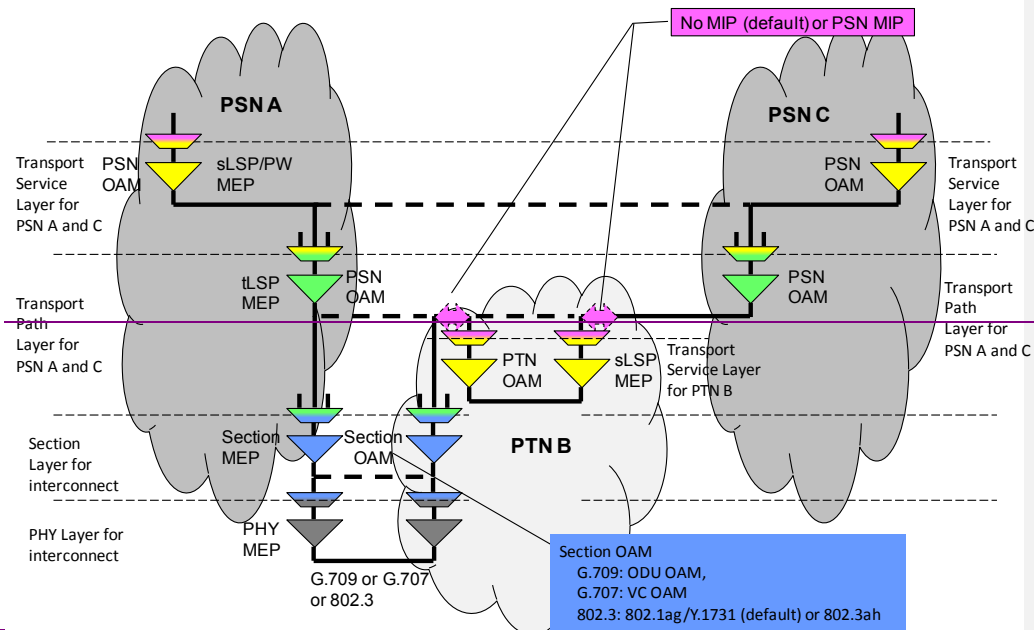
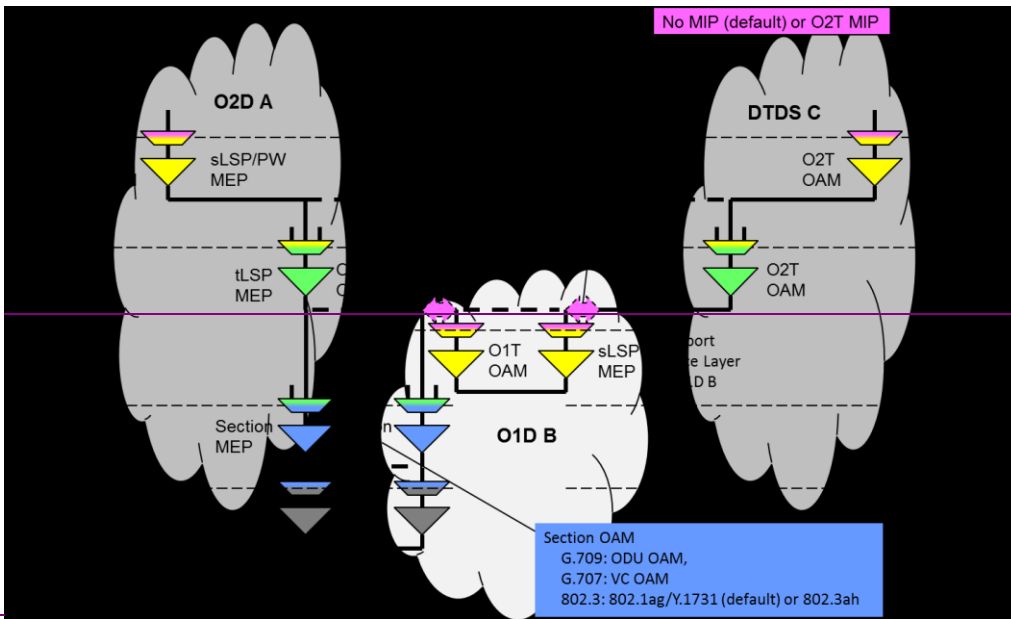

Figure B.3 Interconnection case 2) PSN O2T client over an PTN O1T server

Further details of this are provide in figure B.4 below:



- **Figure B.4 Interconnection case 2) PSN O2T client over an PTN O1T server**
- Support of an PSN O2T MIP within the PTN O1D network is optional.
- B.3 LSP or PW originating in a domain using the default G.8113.2 OAM tool set and terminating in a domain using the G.8113.1 OAM tool set originating in a PTN network and terminating in a PSN network
- In this case where the PW (or LSP) originates (or terminates) in a originating in a domain using the default G.8113.2 OAM tool set and terminating in a domain using the G.8113.1 OAM tool set

Formatted: Highlight

Formatted: Highlight

PTN and terminates (or originates) in a domain using the G.8113.1 OAM optional tool set (O1D)PSN. The default OAM used for the end-to-end LSP or PW is default tool set (O2T) as defined in [ITU-T G.8113.2]PSN. The G.8113.1 PTN OAM tool set may be used if the both network operators mutually agree to select this option. The default option is illustrated in Figure B.5 below.

Formatted: Highlight

Formatted: Highlight

Formatted: enumlev1

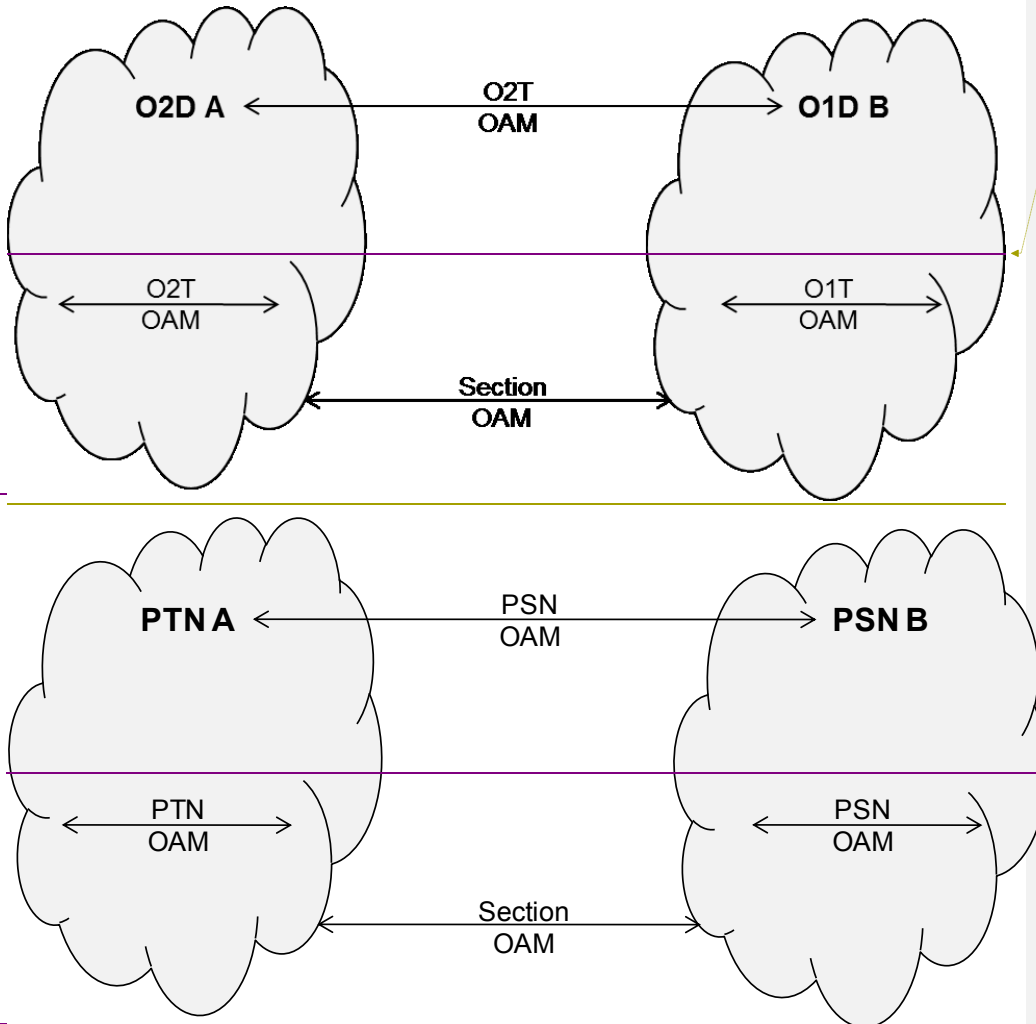

Figure B.5 Interconnection case 3) PTN O2D to PSN O1D

Further details of the default option are provided in figure B.6 below.

Formatted: enumlev1

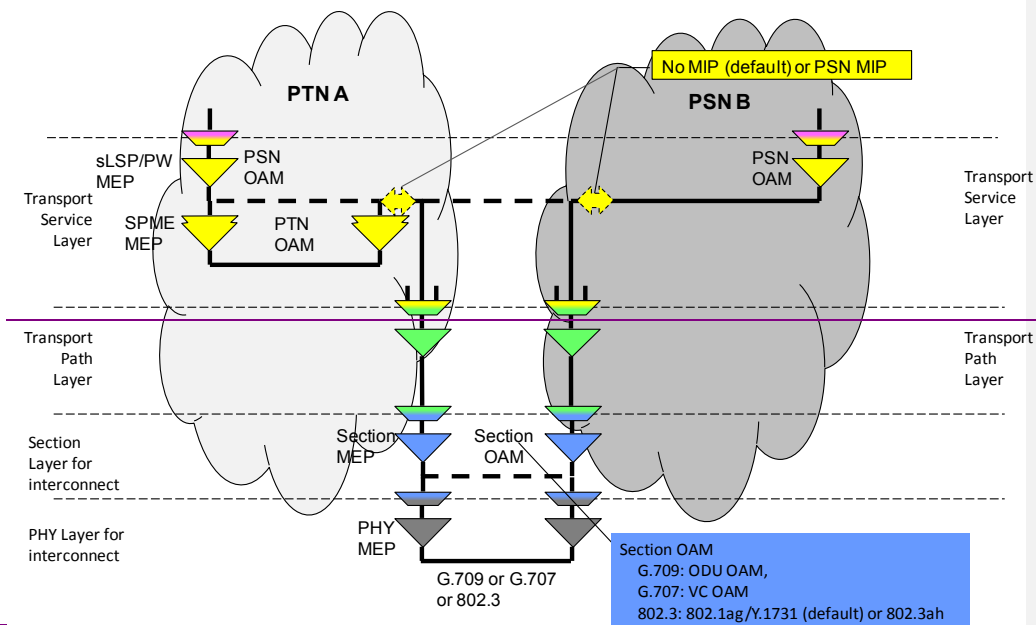
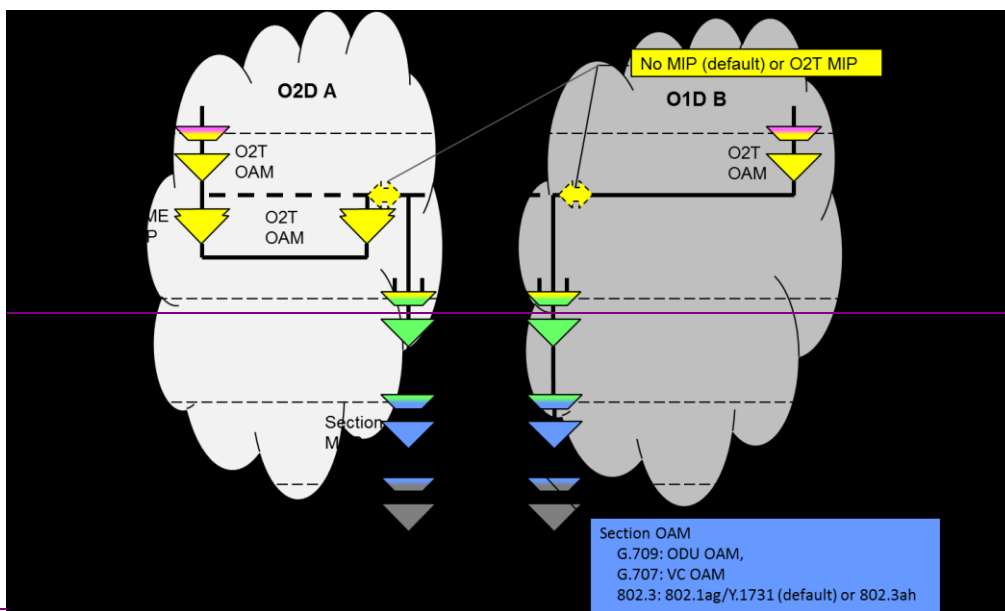

Figure B.6 Interconnection case 3) PTN O2D to PSN O1D

In this case the PTN network elements in O1D that originate or terminate the LSP or PW are required to support PSN O2T OAM for the termination or origination of an end-to-end LSP or PW OAM. Support of the PSN O2T MIP function in the PTN network O1D is optional.

Appendix I

An example of MPLS-TP layer structure

(This appendix does not form an integral part of this Recommendation)

Unlike SDH and ATM technologies, which have a fixed number of layer network instances, MPLS-TP supports an arbitrary number of layer network instances. The number of layer network instances is in practice limited by physical limits (e.g. the MTU of the underlying physical links).

MPLS-TP technology can be used in a number of ways to implement packet transport networks.

This appendix provides an example of a layer structure in a MPLS-TP network that could be implemented using the MPLS-TP technology. Alternative layer structures are not precluded.

This MPLS-TP network example contains three MPLS-TP layer network instances. These MPLS-TP layer network instances are PW, LSP and Section.

The PW layer network instance provides the transport service layer as defined in [IETF RFC 5654]. The PW layer network instance provides OAM for inherent monitoring of the network connection that supports the client service. The structure of the client service is outside the scope of this Recommendation and it may comprise a single client signal or a bundle of such client signal.

The LSP layer network instance provides the transport path layer as defined in [IETF RFC 5654]; a LSP connection carries one or more PW signals between the edges of LSP domains.

An optional MPLS-TP Section (MTS) layer network instance provides the section layer as defined in [IETF RFC 5654]; a MTS connection carries one or more LSP signals between MPLS-TP network nodes. The MTS layer network instance provides OAM for connection monitoring of the point-to-point transmission media layer signal that interconnects MPLS-TP network nodes. This optional MTS layer network instance would typically be used in cases where the physical media layer does not support the required OAM functionality adequately, the MTS connection spans more than one physical link or the MTS connection is protected.

Note that because there is a one-to-one relationship between the MTS layer network instance and the server layer trail, no MTS label stack entry is added to the frames sent over the PHY media (reference point 9 in ~~Figure I-1~~ ~~Figure I-4~~ below). This requires operating the Server/MT_A function according to mode 2 (as described in section ~~7.37.3~~).

Note that in order to be able to apply the MTS layer network instance in practical networks, the server layer connection must have a point-to-point topology.

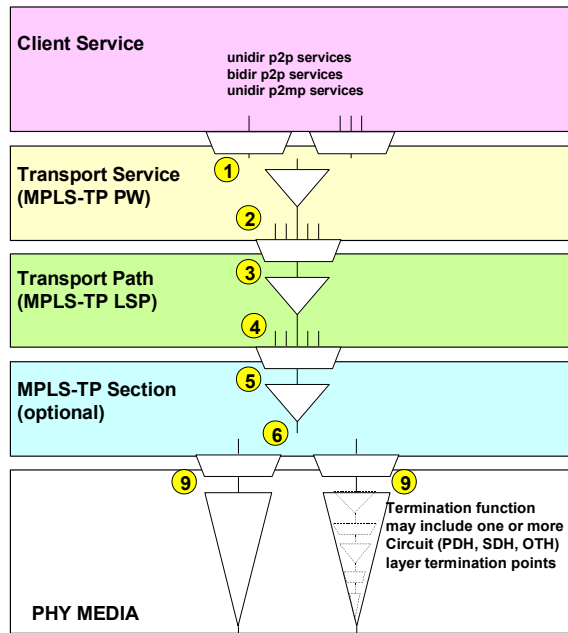

Figure I-1 – MPLS-TP network architecture (layer view) example

~~The MPLS-TP network supports MPLS-TP OAM in the MPLS-TP layer network instances. MPLS-TP OAM protocols are under definition by a set of IETF Internet Drafts. [ITU-T G.8113.1] provides, via referencing these Internet Drafts, an overview of the complete MPLS-TP OAM toolset.~~

It is possible to support carrier's applications at any of the MPLS-TP layer network instances. The MPLS-TP network of one operator (B) may carry any one of the MPLS-TP layer network instances of another operator (A) as a client layer service. Alternatively the MPLS-TP network of one operator (B) may emulate a physical interconnection between the MPLS-TP devices of another operator (A) and carry the full stack, including the PHY information as a client layer service.

NOTE – The emulation of a physical interconnection between MPLS-TP devices, via another operator's MPLS-TP network, cannot support all the properties of a real physical interconnection (e.g. synchronization).

MPLS-TP networks of two operators (C, D) may also peer at the PW layer network instance. This mode of operation (peering) would typically be preferred to a client-server relationship between the networks when the client layer service has endpoints on both MPLS-TP operator networks C and D.

MPLS-TP OAM mechanisms support MPLS-TP tandem connection monitoring (TCM). TCM will allow each owner (service provider, network operators C and D) to monitor its tandem connection.

MPLS-TP networks provide both unidirectional and bidirectional point-to-point and unidirectional point-to-multipoint MPLS-TP connections. Within the PW layer network instance, those connections support bidirectional point-to-point and unidirectional point-to-multipoint services.

The adapted information (AI), characteristic information (CI) and OAM information (OI) traffic unit formats in the different layer networks are illustrated in ~~Figure I-2~~ [Figure I-2](#) to

Figure I-7. The information is numbered between 1 and 9, whose numbers relate to the location of this information in Figure I-1.

Note that the MTS_AI in Figure I-5 contains the S bit for a MTS label stack entry and the MTS_CI in Figure I-6 contains both the S bit and the TTL field for a MTS label stack entry. From a functional point of view, the Server/MT_A_So function, operating according to mode 2 as described in clause 7.37.3, removes the S bit and the TTL field from the MTS label stack entry before sending the frame to the PHY media. In the sink direction, the Server/MT_A_Sk function, operating according to mode 2 as described in clause 7.37.3, inserts, from a functional point of view, an S bit equal to 0 and a TTL field equal to 254.

Therefore no MTS label stack entry is present on the frames sent over the PHY media (Figure I-7).

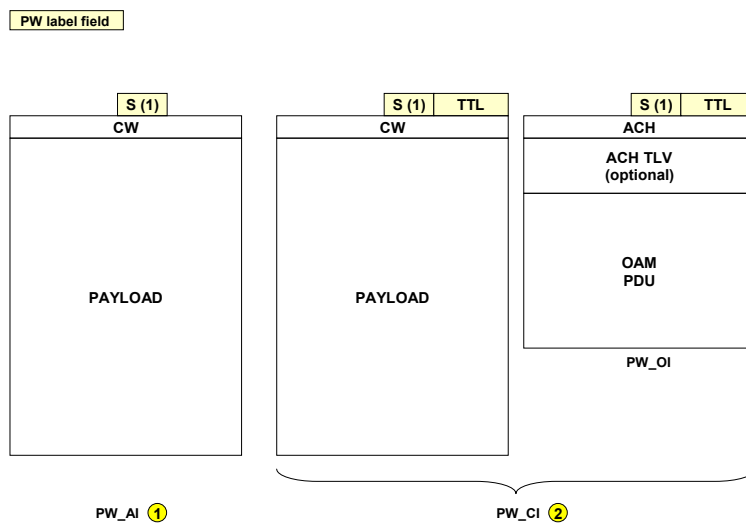

Figure I-2 – MPLS-TP network adapted and characteristic information traffic units (Reference points 1 and 2)

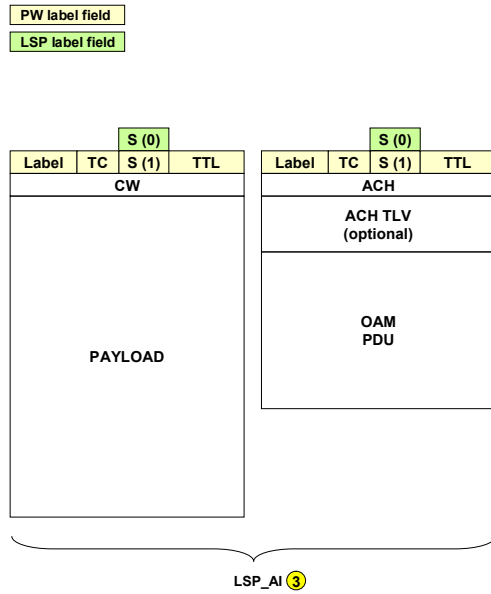

Figure I-3 – MPLS-TP network adapted and characteristic information traffic units (Reference point 3)

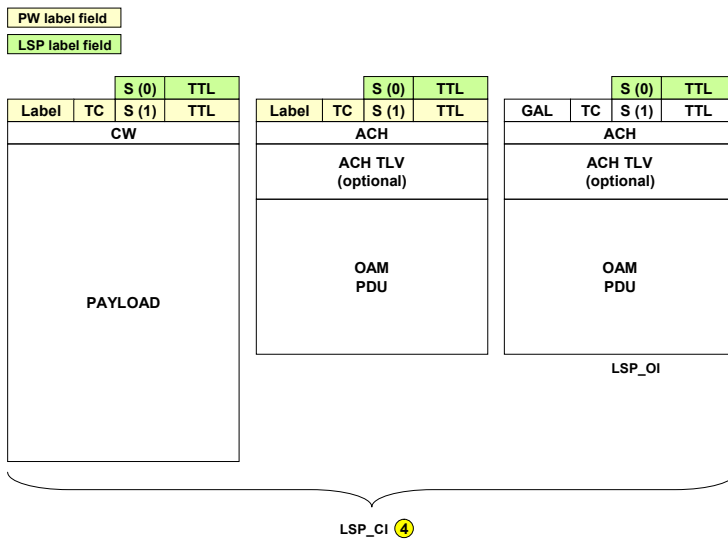
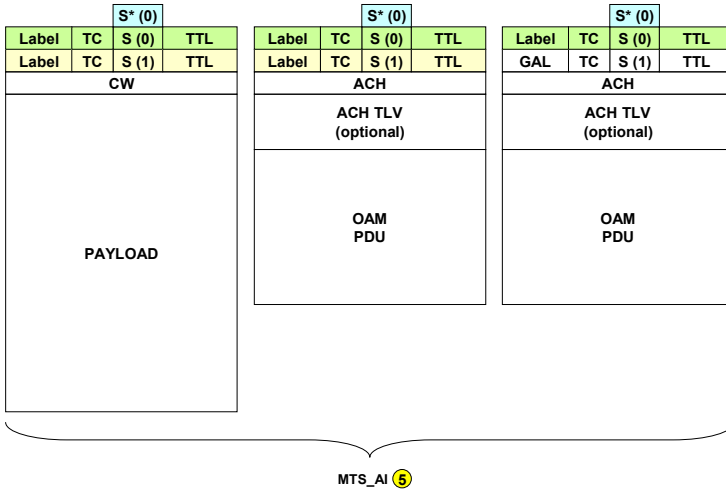

Figure I-4 – MPLS-TP network adapted and characteristic information traffic units (Reference point 4)

PW label field
 LSP label field
 MTS label field*



*) The MTS label stack entry fields are removed by the physical media adaptation source function

Figure I-5 – MPLS-TP network adapted and characteristic information traffic units (Reference point 5)

- PW label field
- LSP label field
- MTS label field*

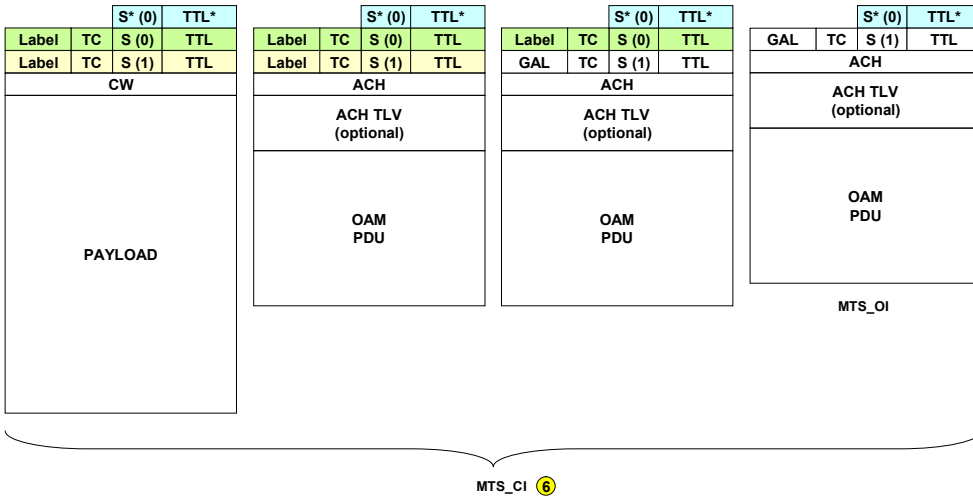

*) The MTS label stack entry fields are removed by the physical media adaptation source function

Figure I-6 – MPLS-TP network adapted and characteristic information traffic units (Reference point 6)

PW label field
 LSP label field

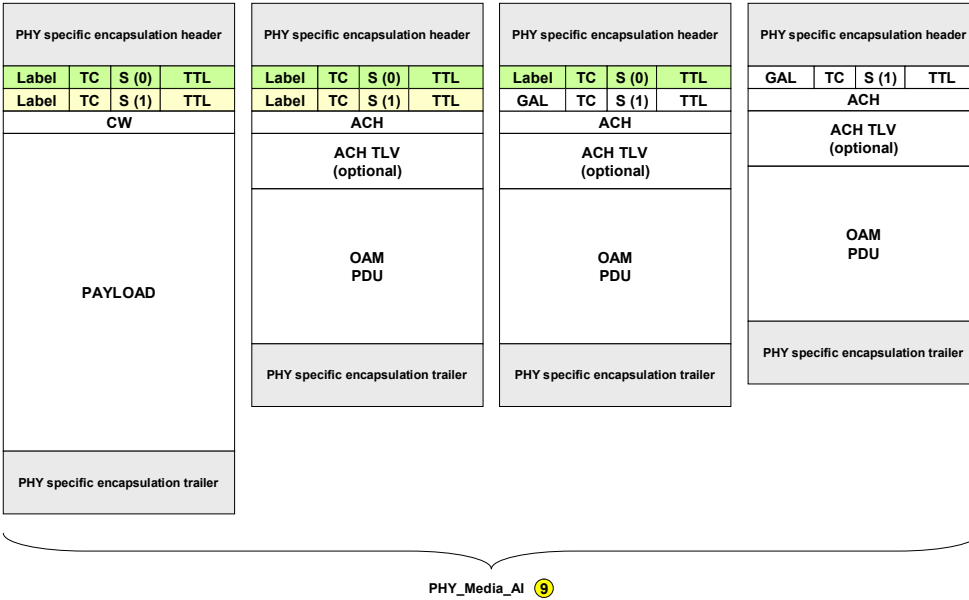

Figure I-7 – MPLS-TP network adapted and characteristic information traffic units (Reference point 9)

Bibliography

- [~~b~~-ITU-T G.808.2] ITU-T ~~Draft~~ Recommendation G.808.2 (~~2009~~), *Generic protection switching – Ring protection.*
- [b-ITU-T G.8121] ITU-T **Draft Revised** Recommendation G.8121/Y.1381 (**2011**), *Characteristics of MPLS-TP equipment functional blocks.*
- [b-IANA Reg] IANA, Registered Label Values for Multiprotocol Label Switching Architecture (MPLS).
<<http://www.iana.org/assignments/mpls-label-values/mpls-label-values.xhtml>>
- [b-IETF RFC 3985] IETF RFC 3985 (2005), *Pseudo Wire Emulation Edge-to-Edge (PWE3) Architecture.*
- [b-IETF RFC 4124] IETF RFC 4124 (2005), *Protocol Extensions for Support of Diffserv-aware MPLS Traffic Engineering.*
- [b-IETF RFC 4461] IETF RFC 4461 (2006), *Signaling Requirements for Point-to-Multipoint Traffic-Engineered MPLS Label Switched Paths (LSPs).*
- [b-IETF RFC 5950] IETF RFC 5950 (2010), *Network Management Framework for MPLS-based Transport Networks.*
- [b-IETF RFC 5951] IETF RFC 5951 (2010), *Network Management Requirements for MPLS-based Transport Networks.*
- [b-IETF ~~RFC 6373~~ ~~ts-tp-06~~] IETF ~~Internet-Draft-draft-ietf-ccamp-mpls-tp-cp-framework-06.txt~~ RFC 6373 (2011), MPLS Transport Profile (MPLS-TP) Control Plane Framework~~MPLS TP Control Plane Framework.~~
- [b-IETF RFC 6372 ~~ts-surv-06~~] IETF ~~Internet-Draft-draft-ietf-mpls-tp-survival-fwk-06.txt~~ RFC 6372 (2011), MPLS Transport Profile (MPLS-TP) Survivability Framework~~Multiprotocol Label Switching Transport Profile Survivability Framework.~~
- [b-IETF ~~ts-itu-06~~] IETF ~~Internet-Draft-draft-ietf-mpls-tp-itu-t-identifiers-01.txt~~ (~~2011~~), MPLS-TP Identifiers Following ITU-T Conventions.

Formatted: Not Highlight

Formatted: Highlight