

Practical PoE Tutorial

Chris DiMinico, MC Communications/Panduit

Chad Jones, Cisco Systems

Ron Nordin, Panduit

Lennart Yseboodt, Philips Lighting

Berlin, Germany

July 10, 2017

Agenda

- **Background/Scope**
 - **Chris DiMinico**
- **Intro to PoE and related industry testing**
 - **Chad Jones**
- **Test set up**
 - **Ron Nordin**
- **Test results and impact**
 - **Lennart Yseboodt**
- **Wrap-Up**
 - **Chris DiMinico**
- **Q&A**

Background/Scope

- **Power delivery over BASE-T PHYS (4-pair,2-pair,1-pair)**
 - **IEEE Std 802.3af-2003 DTE Power via media dependent interface (MDI)**
 - **IEEE Std 802.3at-2009 DTE Power Enhancements**
 - **IEEE P802.3bt DTE Power via MDI over 4-Pair Task Force**
 - **10M/100M/1G/2.5G/5G/10G (4-pair,2-pair)**
 - **IEEE Std 802.3bu-2016 1-Pair Power over Data Lines (PoDL)**
 - **10M/100M/1G/10G (2.5G/5G) (1-pair)**
 - **An objective of Power over Ethernet: A PSE designed to the standard does not introduce non-SELV (Safety Extra Low Voltage*) power into the wiring plant.**
- **Non-automotive BASE-T PHYs have specified operation over TIA/ISO cabling; with functional use over a temperature range from -10 °C to 60 °C.**
IEEE Link Segments transmission performance consistent with TIA/ISO temperature range.

*SELV power as defined in IEC 60950-1.

Background/Scope

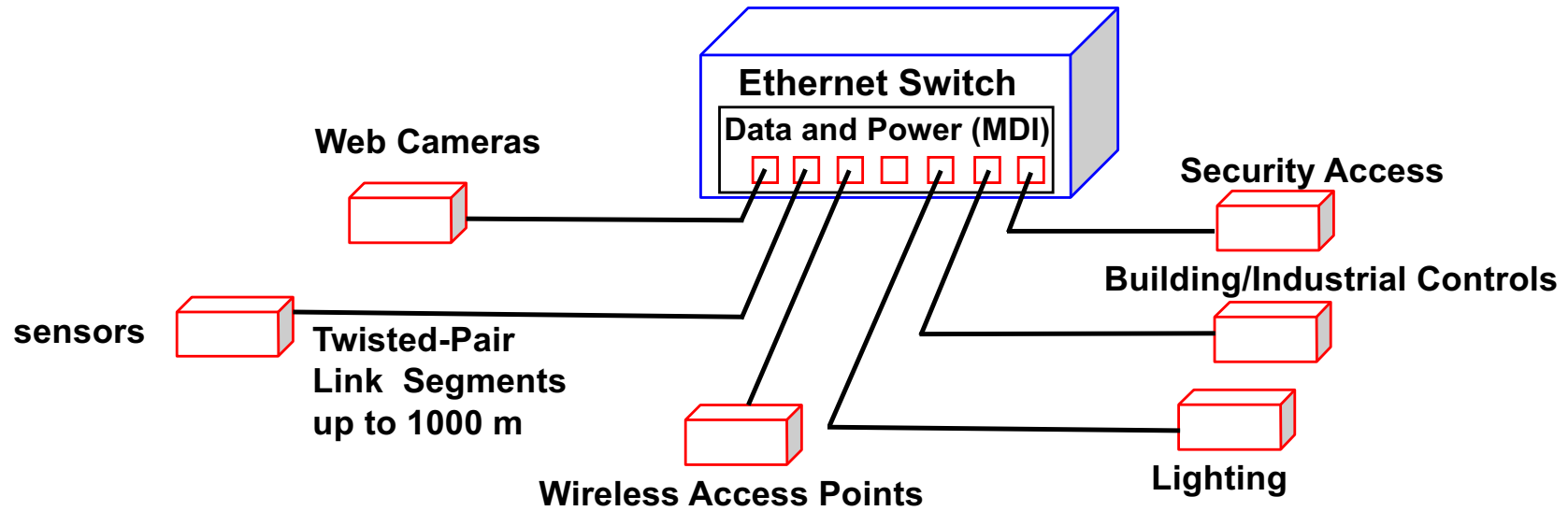

ISO/IEC/ANSI/TIA: Remote Powering Support; Telecommunications Cabling, Pathways and Spaces



Automotive Operating Environment: Temperature and EMC – Link Segments up to 40 m

Background/Scope

- **ISO/IEC/TIA guidelines to support (SELV) limited power source (LPS) applications. Referenced in PoE; guidelines include considerations for temperature rise and current capacity of bundled cabling.**
- **Developed to support Power over Ethernet; cooperative effort through liaison process.**
 - **ISO/IEC TR29125 and TIA TSB-184 (2009)**
 - **ISO/IEC TS29125 and TIA TSB-184-A (2017)**
- **Under Development**
 - **Addendum to ANSI/TIA 569-D - Additional pathway and space considerations for supporting remote powering over balanced twisted pair cabling**
 - **ISO/IEC EN 50174-1: Installation specification - Technical specification to detail remote powering objectives using equipment in accordance with EN 62368-3.**

Background/Scope

- **2017 revisions to the National Electric Code include a table of ampacities (Table 725.144) for 4-Pair Class 2 or Class 3 data cables with temperature rating of 60° C, 75° C, and 90° C for up to 192 4-pair cables in a bundle.**

TABLE 725.144, Ampacities of Each Conductor (in Amperes) in a 4-Pair Class 2 or Class 3 Data Cable, Based on Copper Conductors at Ambient Temperature of 30°C (86°F) with All Conductors in All Cables Carrying Current, 60°C (140°F), 75°C (167°F) and 90°C (194°F) Rated Cables

AWG	Number of 4-Pair Cables in a Bundle																				
	1			2-7			8-19			20-37			38-61			62-91			92-192		
	Temp Rating			Temp Rating			Temp Rating			Temp Rating			Temp Rating			Temp Rating					
	60°C	75°C	90°C	60°C	75°C	90°C	60°C	75°C	90°C	60°C	75°C	90°C	60°C	75°C	90°C	60°C	75°C	90°C	60°C	75°C	90°C
26	1.0	1.0	1.0	1.0	1.0	1.0	0.7	0.8	1.0	0.5	0.6	0.7	0.4	0.5	0.6	0.4	0.5	0.6	NA	NA	NA
24	2.0	2.0	2.0	1.0	1.4	1.6	0.8	1.0	1.1	0.6	0.7	0.9	0.5	0.6	0.7	0.4	0.5	0.6	0.3	0.4	0.5
23	2.5	2.5	2.5	1.2	1.5	1.7	0.8	1.1	1.2	0.6	0.8	0.9	0.5	0.7	0.8	0.5	0.7	0.8	0.4	0.5	0.6
22	3.0	3.0	3.0	1.4	1.8	2.1	1.0	1.2	1.4	0.7	0.9	1.1	0.6	0.8	0.9	0.6	0.7	0.8	0.5	0.6	0.7

Note 1: For bundle sizes over 192 cables, or for conductor sizes smaller than 26 AWG, ampacities shall be permitted to be determined by qualified personnel under engineering supervision. Note 2: Where only half of the conductors in each cable are carrying current, the values in the table shall be permitted to be increased by a factor of 1.4. Informational Note: The conductor size in data cables in widespread use are typically 22-26 AWG.

Background/Scope

- Table 725.144: Note 2: **Where only half of the conductors in each cable are carrying current, the values in the table shall be permitted to be increased by a factor of 1.4.**
- Ampacities of each conductor (Amperes)

AWG	Number of 4-Pair Cables in a Bundle						
	1	2 to 7	8 to 19	20 to 37	38 to 61	62 to 91	92 to 192
	60 ° C	60 ° C	60 ° C	60 ° C	60 ° C	60 ° C	60 ° C
26	1.40	1.40	0.98	0.70	0.56	0.56	NA
24	2.80	1.40	1.12	0.84	0.70	0.56	0.42
23	3.50	1.68	1.12	0.84	0.70	0.70	0.56
22	4.20	1.96	1.40	0.98	0.84	0.84	0.70

Background/Scope

- TSB-184 and addendum and the NEC bundled cabling considerations (Table 725.144) assumes every cable carries the worst case current I_{Cable}

Examples of Bundled Cables



Background/Scope

- **The tutorial will provide an application based analysis of the temperature rise over the ambient temperature for a distribution of cable bundle lengths representative of the installed cabling using a constant power load.**
 - **Compare results to constant current source.**
 - **Enable broader understanding of real PoE powering and contribute to efforts in TIA and NEC addressing powering over communications cables.**
 - **Ethernet (1000BASE-T) operation was considered during the testing.**

Intro to 802.3bt and Related Industry Testing

New Types, Classes

IEEE P802.3bt introduces two new Types and four new Classes

Type 3

Covers Classes 1-6

Classes 1-4 as before (i.e. IEEE 802.3-2015)

Class 5: 45W PSE, 40W PD

Class 6: 60W PSE, 51W PD

Minimum port voltage = 50V

Type 4

Covers Classes 7 and 8

Class 7: 75W PSE, 62W PD

Class 8: 90W PSE, 71.3W PD

Minimum port voltage = 52V

The PSE power is the worst case to guarantee interoperability.

Current Required for Interoperability

- **The standard must assume worst case operating parameters to maximize interoperability. This results in the following maximum port current per Class:**

Class	Vpse (V)	Ppse (W)	Iport (A)	Pair (A)	Conductor(A)
5	50	45	0.900	0.450	0.23
6	50	60	1.200	0.600	0.30
7	52	75	1.442	0.721	0.36
8	52	90	1.731	0.866	0.43

- **ALL cable plant testing to this point focused on these worst case numbers (Constant Current)**

PoE: a Voltage Source with Constant Power PDs

- A typical system rarely supplies worst case current.

Cable current (I_{cable}) is determined by:

PSE Port Voltage (V_{pse})

Cable resistance (R_{cable})

PD power (P_{pd})

- For a system to supply maximum I_{Cable} , each of these 3 parameters needs to be precisely at worst-case.
- The equation for PoE power delivery:

$$I_{cable} = \frac{V_{pse} - \sqrt{V_{pse}^2 - 4(R_{cable})(P_{pd})}}{2(R_{cable})}$$

802.3bt Worst Case

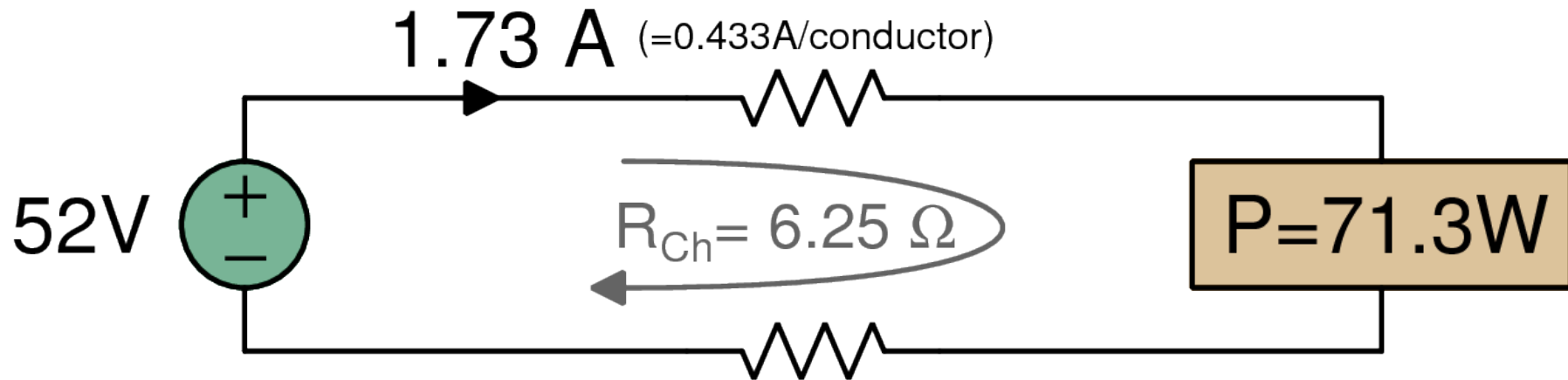

Worst case channel of 6.25 Ω

Load: constant power of 71.3 W (Class 8)

Type 4, Class 8 PDs may take a maximum of 71.3W.

With the lowest allowed PSE voltage of 52V, and the worst supported channel resistance of 6.25 Ohm, a current of 1.73A flows through the cable.

1.73A, or 0.433A per conductor, is the highest nominal current that can flow in a compliant system.

Constant Current, 2.0 A

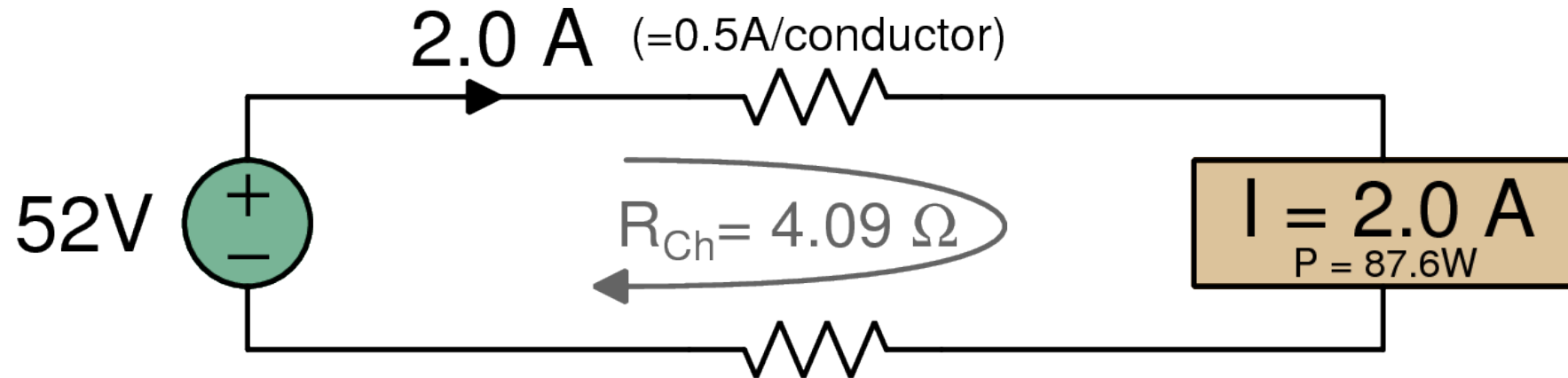

Channel: 24 AWG UTP

Load: constant current of 2.0 A

Some cable heating studies test cable bundles at 2.0A.

If 24AWG cable is used, that leads to a power density in the cable of **164 mW/m**.

Power Density is power dissipated in the cable per unit length.

$$164\text{mW/m} = ((2.0\text{A})^2 * 4.09\text{Ohm}) / 100\text{m}$$

R_{ch} based on resistivity of 24 AWG solid copper at 20° C

Constant Current, 1.73 A

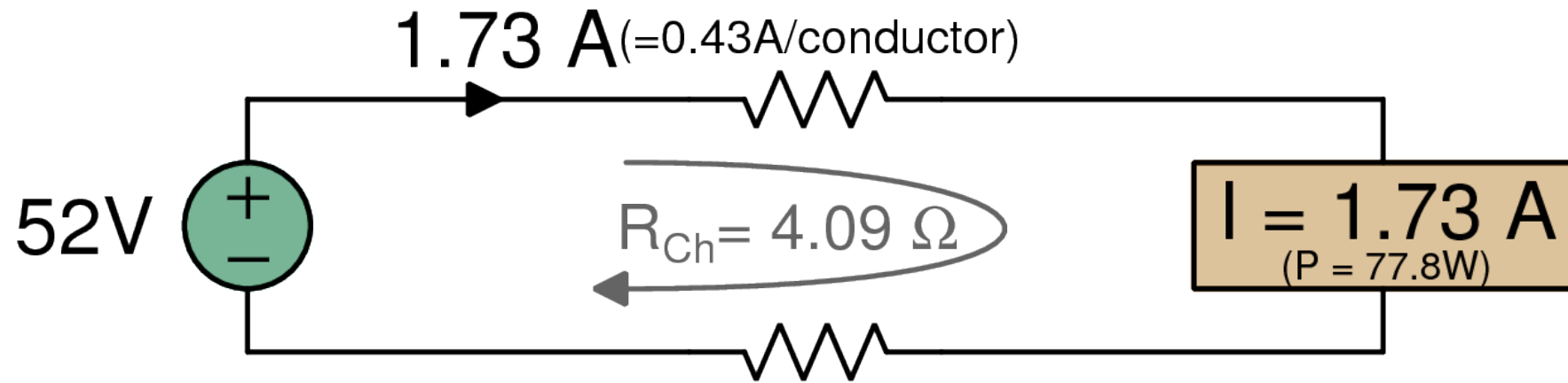

Channel: 24 AWG UTP

Load: constant current of 1.73 A

Using a current of 1.73 A results in a power density of **123 mW/m** with a power delivered of 77.8W ($>71.3\text{W}$).

Constant Power, Class 8

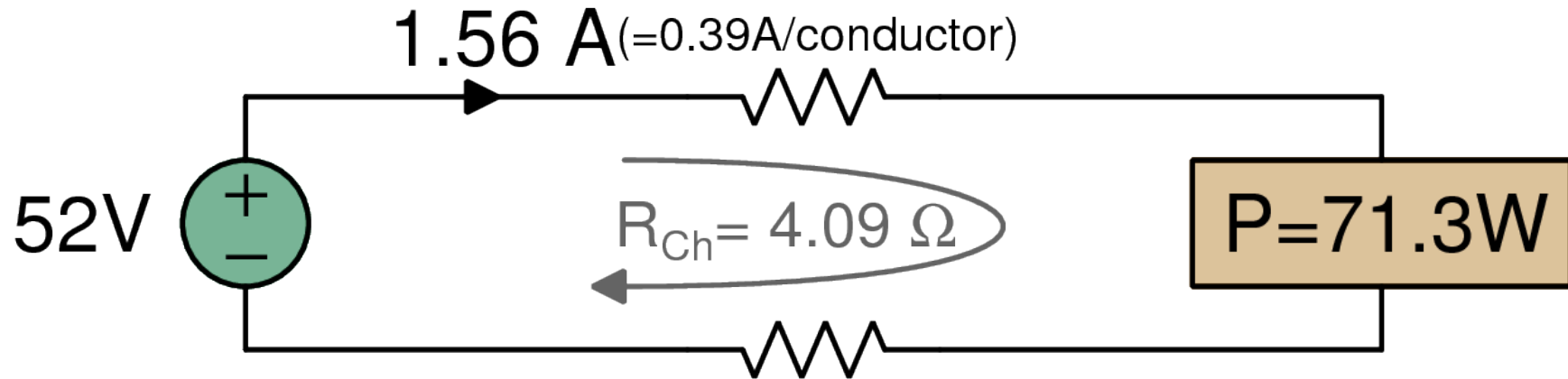

Channel: 24 AWG UTP

Load: constant power of 71.3 W (Class 8)

The correct way to determine power dissipation / heating for any given cable is to use a constant-power sink as the load, and a voltage source as the supply.

For 24AWG cable (100m), 1.56A will flow, with a power density of 100mW/m.

If the cable were 50m, 1.46A will flow, with power density of 87mW/m.

If the cable were 20m, 1.4A will flow, with power density of 80mW/m.

Comparisons Overview

Conditions	Channel	Power density
2.0A fixed current	100m AWG 24	164 mW/m
1.73A fixed current	100m AWG 24	123 mW/m
71.3W load	100m AWG 24	100 mW/m
71.3W load	50m AWG 24	87 mW/m
71.3W load	20m AWG 24	80 mW/m

- Cable bundles consist of cables of varying lengths. The IEEE 802.3 10GBASE-T Tutorial presentation (November 2003) illustrates that 70% < 55 meters.
- Compared to fixed-current measurements taken at 2.0A, the power density in a real system can be off by about a factor 2.
- The resulting temperature increase will be more than a factor of 2.

Constant Power Methodology Versus Constant Current

Constant Current

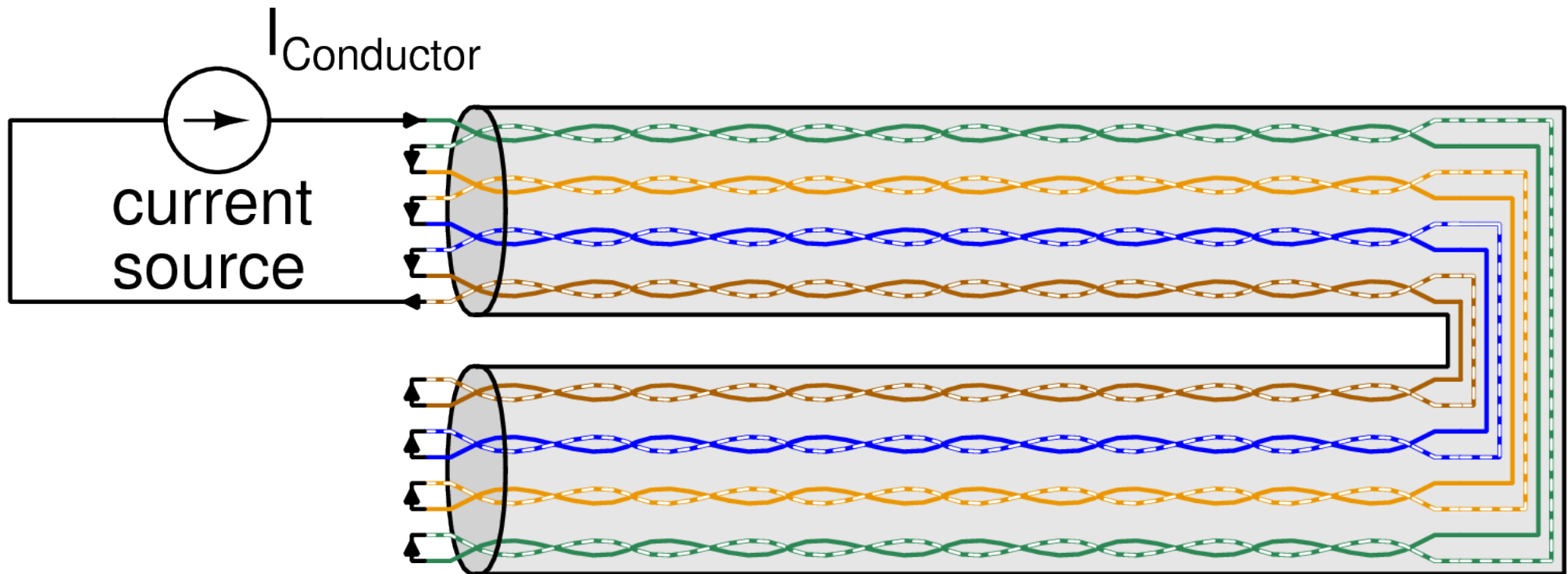

- The bundle is constructed of a single cable looped back on itself to get the desired bundle size.
- The 8 individual conductors are connected to form a long series connection. A current source generates the desired current.

Constant Power

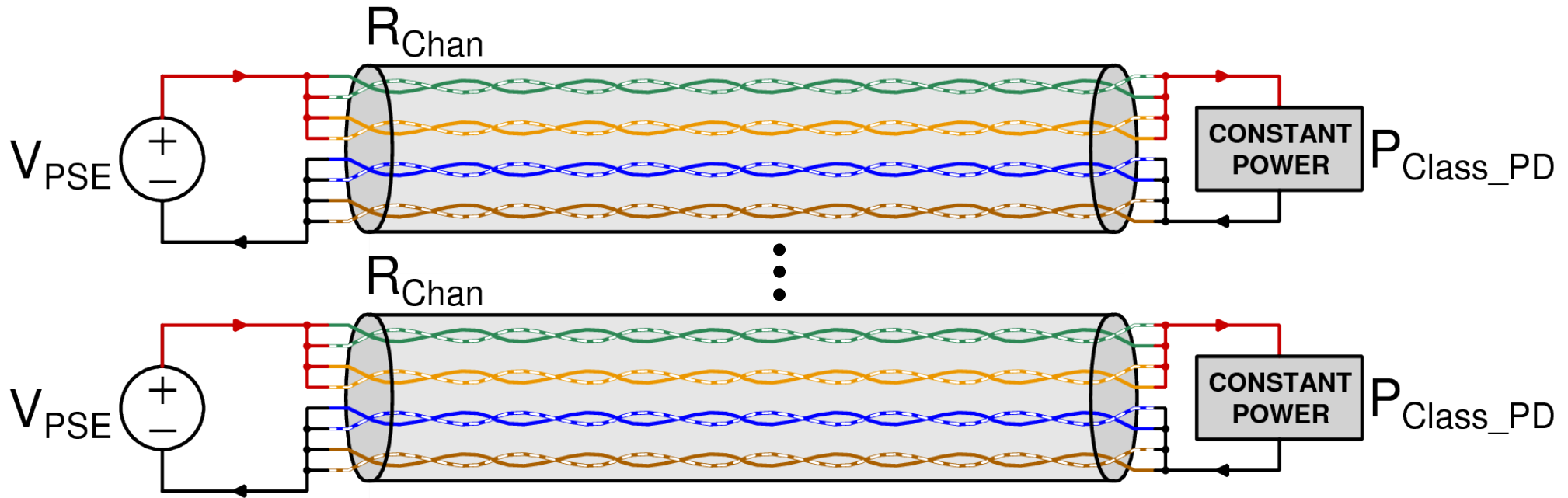

- The bundle is constructed out of separate cables. Each cable is supplied by a voltage source, at the other end of the cable a constant power sink draws the desired amount of power.
- The current drawn is determined by the source voltage, cable resistance and the amount of power sunk.

Current and Temperature Rise

(small current changes leads to large temperature changes)

The importance of the actual current value in the temperature rise above ambient

- The power dissipation within the cable is equal to the current squared times the wire resistance
 $\text{Power} = I^2R$

- The temperature rise above ambient is proportional to the power dissipation squared times the thermal resistance
 $\text{Temperature} = P^2R$

Hence for a reduced value of current within the cabling has a double square law effect on the temperature

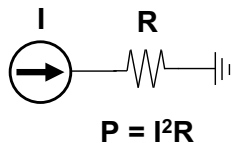

Current (A) Reduction I	Power (W) Reduction P	Temperature (°C) Reduction T
2%	4.0%	7.8%
5%	9.8%	18.5%
10%	19.0%	34.4%
15%	27.8%	47.8%
20%	36.0%	59.0%
25%	43.8%	68.4%

Test Setup

Temperature Test Setup

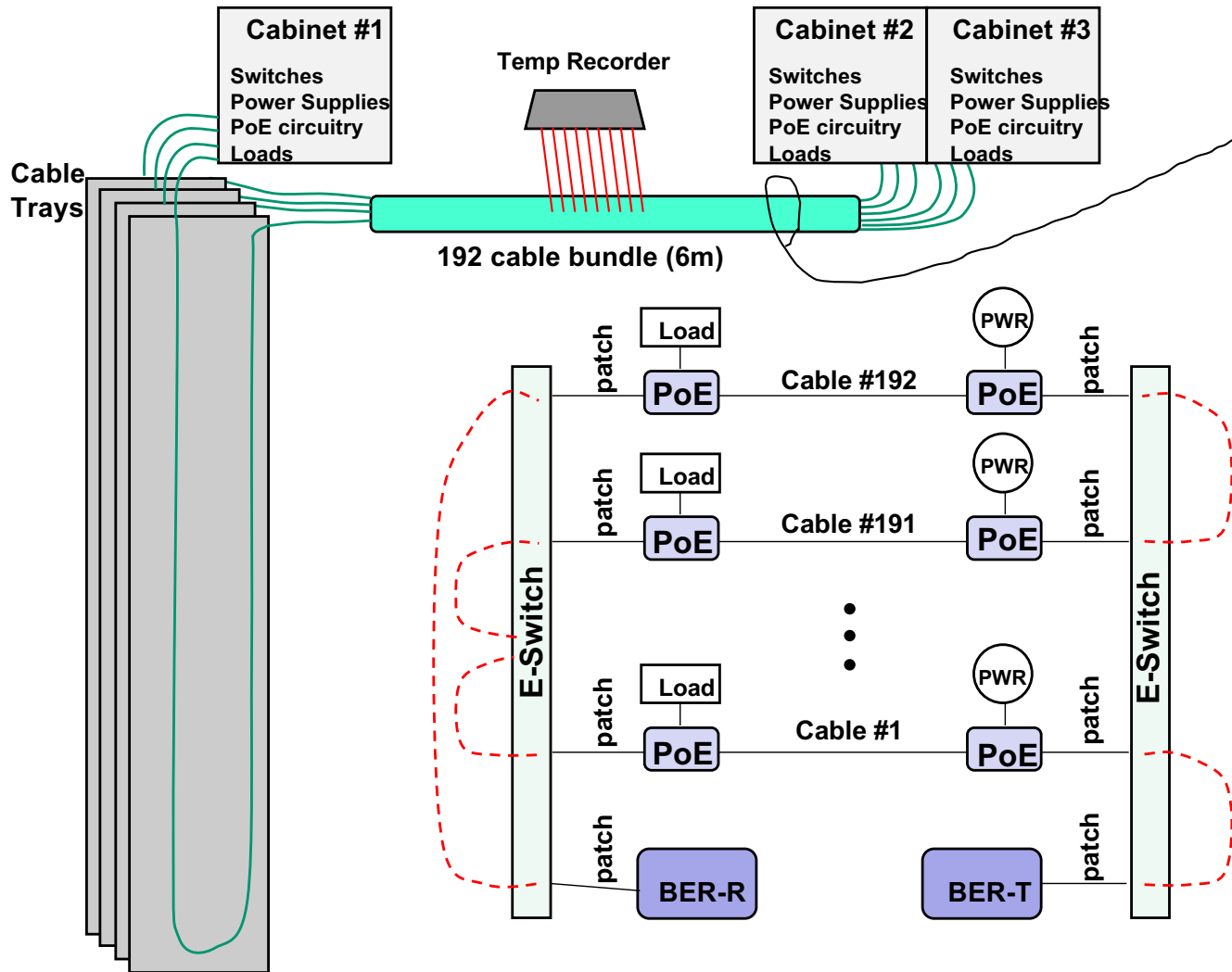

192 Cable Bundle Cross Section

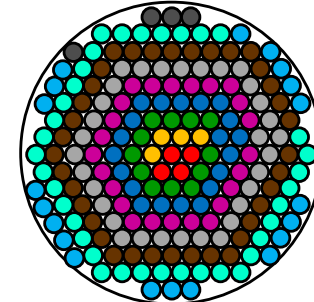

(long cables in the middle – shortest towards the outer)

Consortium Cable Length Distribution		
Length (m)	# cables	
10	4	■
20	20	■
30	36	■
40	36	■
50	32	■
60	24	■
70	20	■
80	12	■
90	4	■
100	4	■
Total#	192	

Power Injection

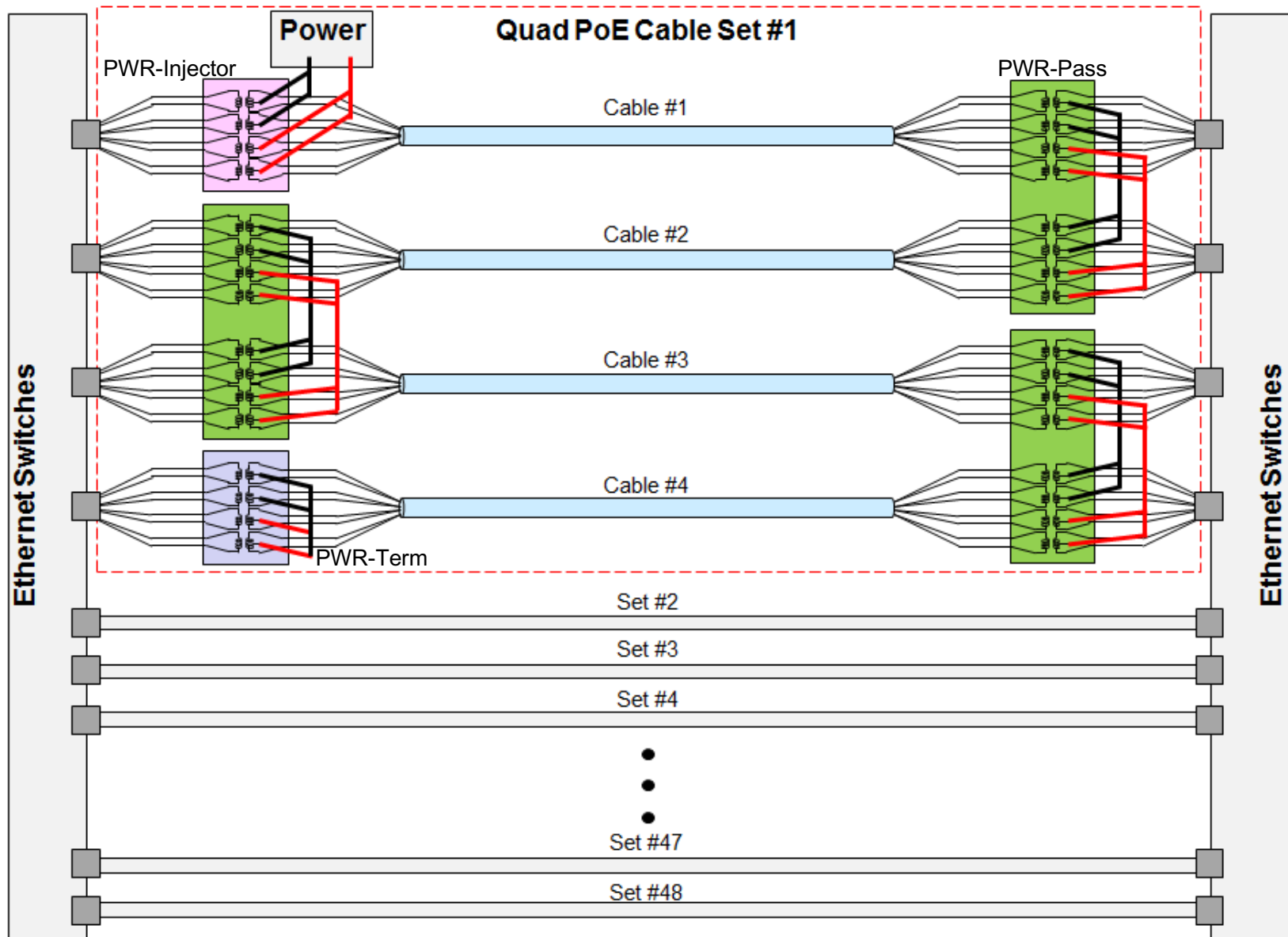

Temperature Test Setup



**9,120m of cable
768 patch cords
384 jacks**

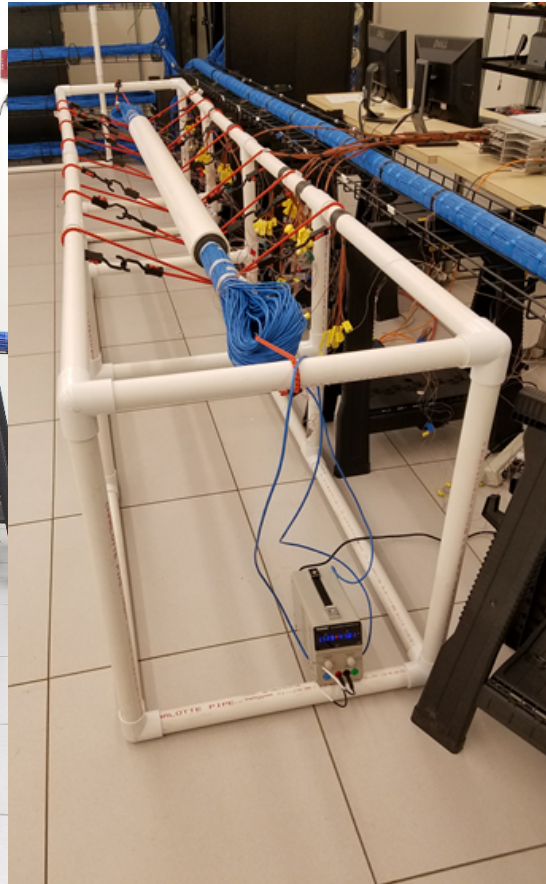

**69 Thermocouples
Scanned every 30s
(5 hr. stability time)**

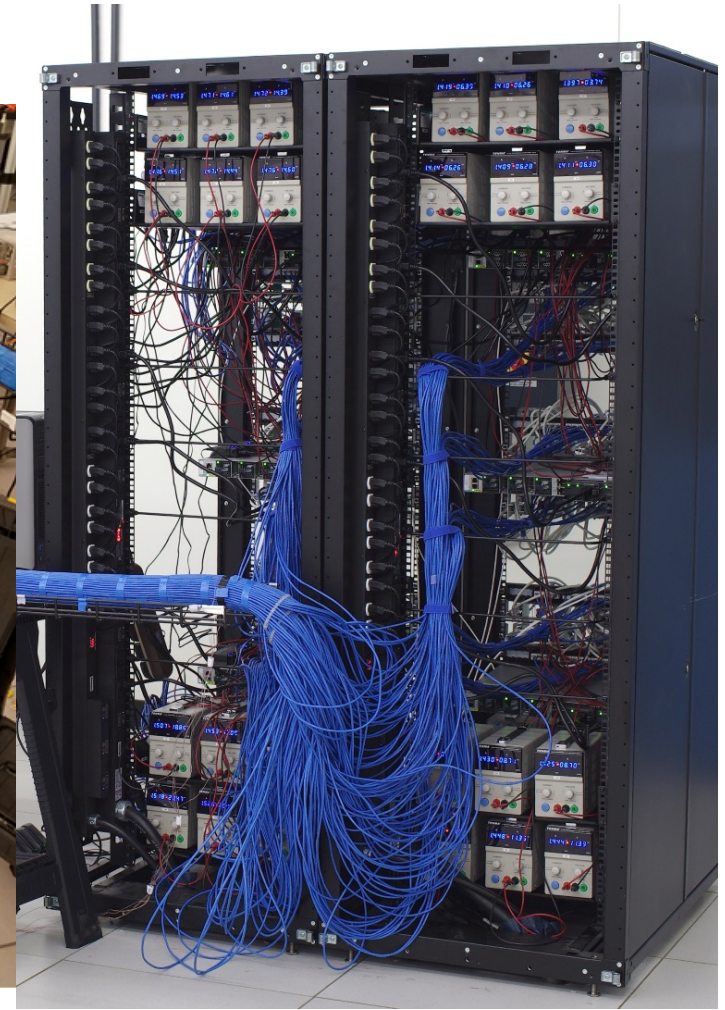

**10 Cisco 48-port switches (3850)
48 Tenma Power Supplies
1 Ixia BER (1 Gbps data rate)
240 Power inject/pass=thru/term Units**

Cable Length Distributions

The total cable lengths of are typically less than 55 meters. Figure below shows the percentages of installed cabling channels versus channel length contributed to IEEE802.3 during the development of 10GBASE-T by several cabling manufacturers illustrating that for the lengths investigated 70% were less than 55 meters.

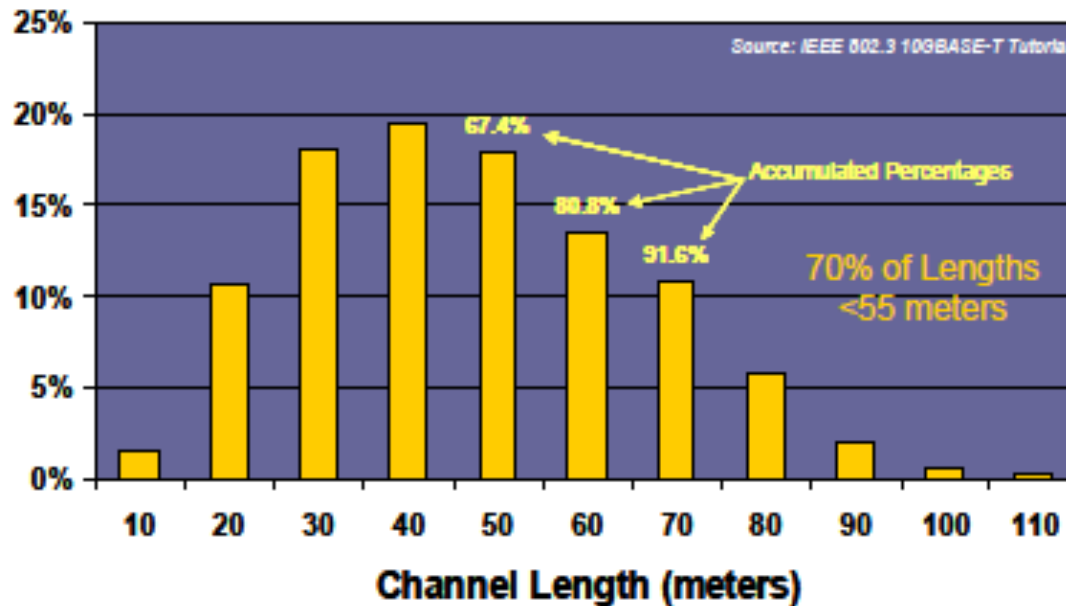

# of Cables	4	20	36	36	32	24	20	12	4	4
percentage	2%	11%	18%	19%	17%	13%	11%	6%	2%	1%
Length (m)	10	20	30	40	50	60	70	80	90	100

Selected Distribution*

References:

1.) IEEE 802.3 10GBASE-T Tutorial (November 2003)

2.) Installed Horizontal Cabling Length Distribution, IEEE 10gBase-T Study Group, July 2003, Alan Flatman

*See appendix for other distribution types

Test Conditions

All conditions run in open air and in conduit in a constant temperature/humidity environment.

For each Class 4 through 8:

- Constant Current at maximum current
- Constant Current at average current
- Constant Power at V_{PSE} minimum
- Constant Power at V_{PSE} nominal
- Constant Power Tracked

(Constant power on 100 m cables. Current on all other cables matched to current in 100 m cables)

Constant Current = 2,000 mA

52 total test conditions

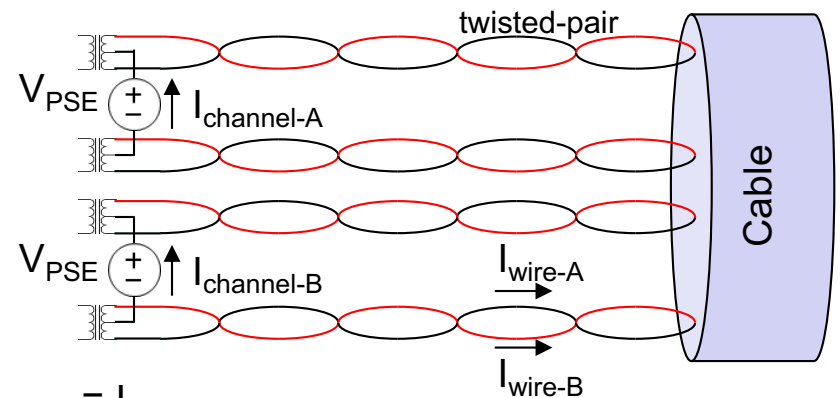

$$I_{wire-A} + I_{wire-B} = I_{channel}$$

$$I_{channel-A} + I_{channel-B} = I_{cable}$$

Test Conditions

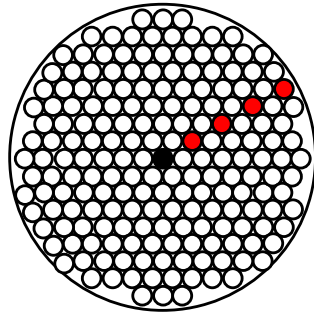

- Thermocouple on cable jacket
- Thermocouple on cable jacket and inside cable

Thermocouple placement within Bundle cross section

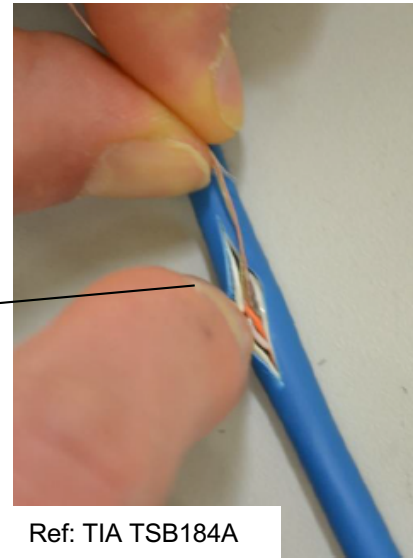

Ref: TIA TSB184A

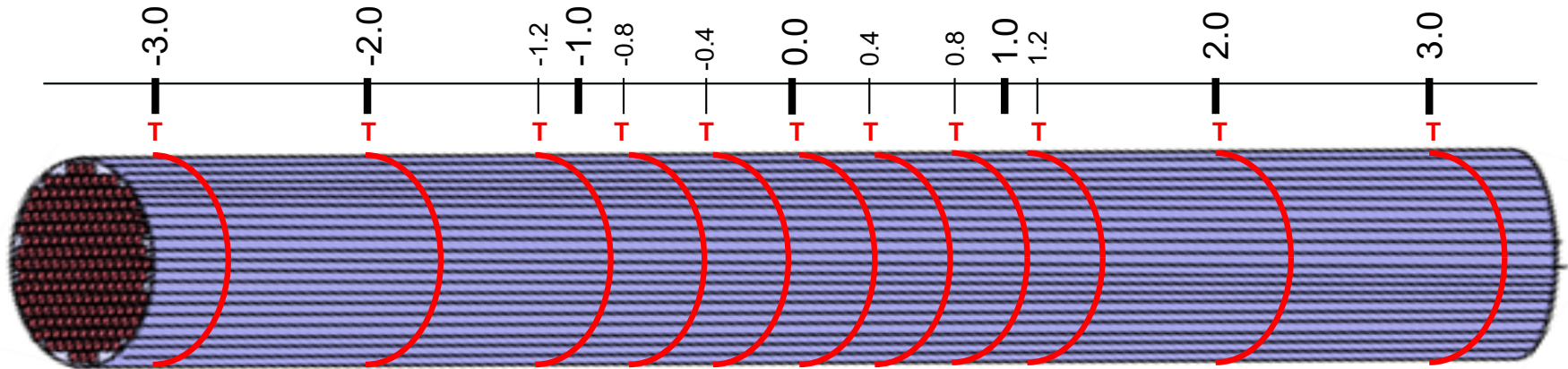

Thermocouple Placement in Cable Bundle (Lengths in m)

Test Results

Powering methods

CL4:CP:54V = Class 4 : Constant Power : PSE voltage 54V

This should be considered a typical PoE case (with Class 4 loads), with constant power PDs using a distribution of cable lengths as described earlier.

CL4:CP:50V = Class 4 : Constant Power : PSE voltage 50V

The same as above, but with the lowest allowed PSE voltage. For Class 7 and 8, the lowest voltage allowed is 52V

CL4:CC:600mA = <Class 4 equivalent> : Constant Current : Current in mA

A fixed current was sourced through the cable. This current denotes the total 4-pair current. For each Class, two CC tests are performed: the lower current represents the calculated average current corresponding with the lowest PSE voltage. The higher current is the theoretical maximum current at the lowest PSE voltage and highest channel resistance.

CL4:CP:Tracked = Class 4 : Constant Power : Tracked current

The sources “track” the current level of the source that powers the longest cable in the bundle (which itself is in Constant Power mode). This emulates as if every cable in the bundle is 100m long.

Type 3 power levels overview (192 x 24AWG)

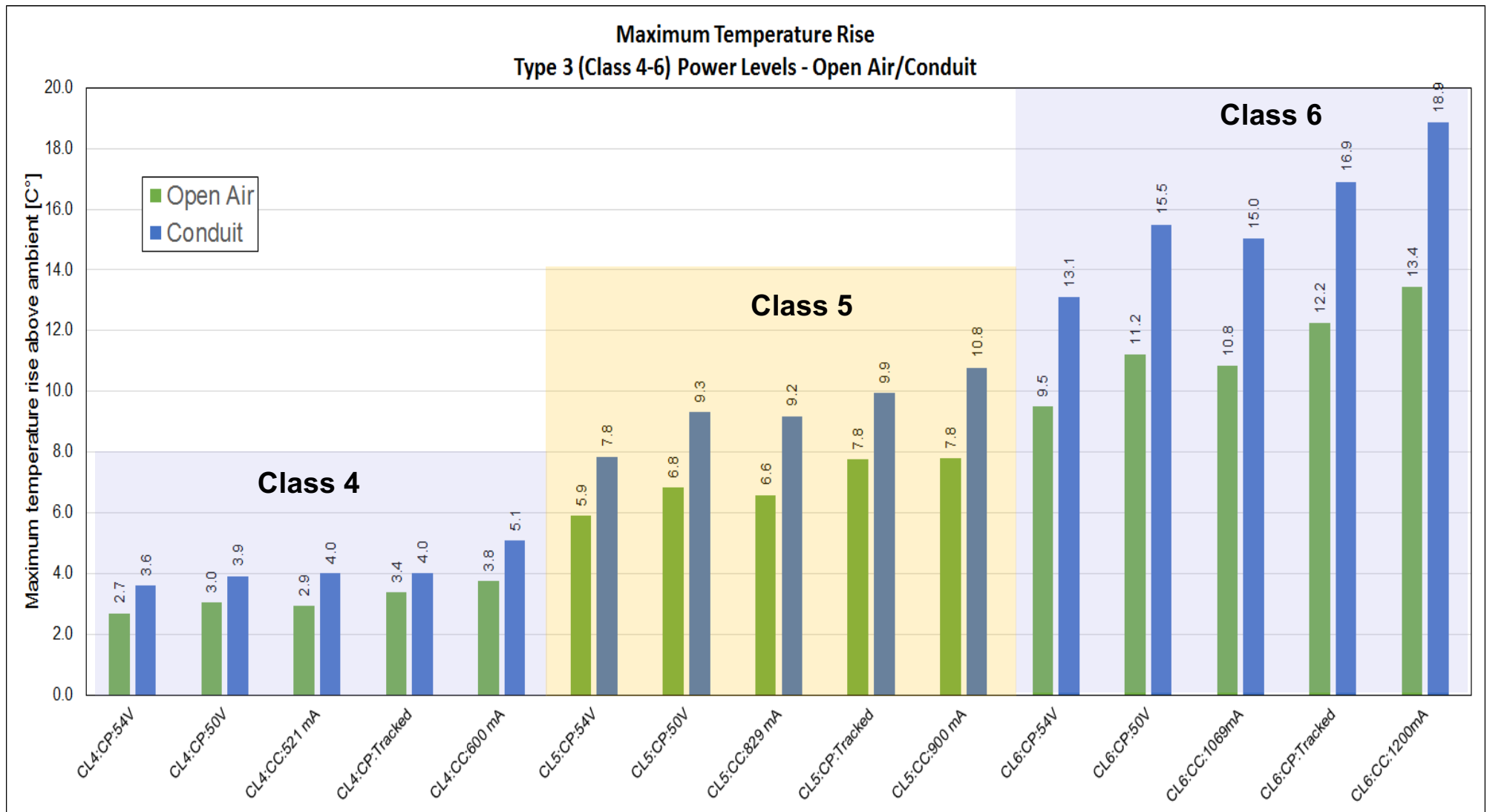

Type 4 power levels overview (192 x 24AWG)

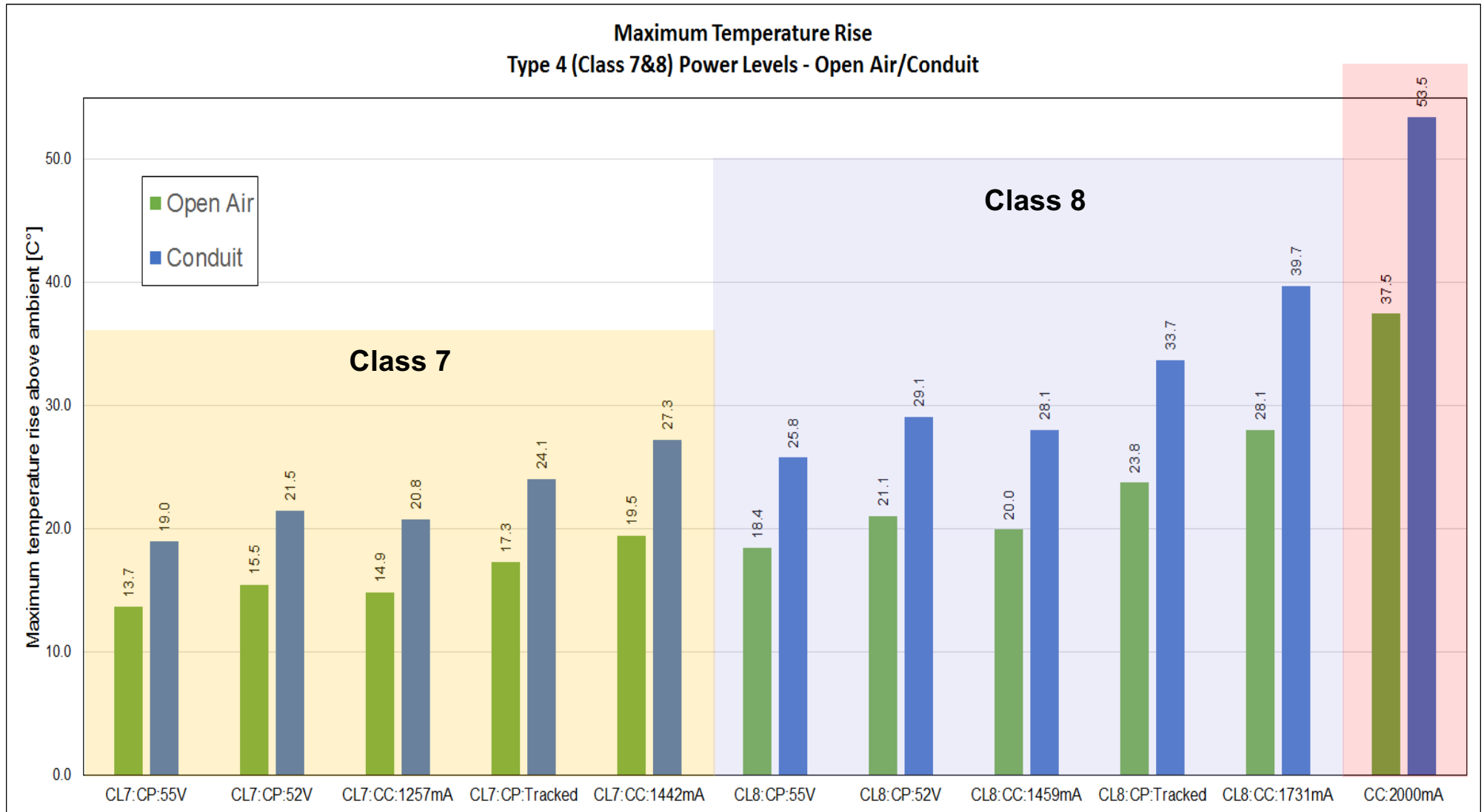

Summary 192 bundle tests

- **Type 3 power levels (9.7 KW of delivered power) are generally below a 15C rise (with the exception of the tracked method at 17C)**
- **Type 4 power levels (13.7 KW of delivered power) are all well above 15C rise**
- **The extreme corner case (Class 8 PD, conduit, 192 powered cables, lowest PSE voltage, all 100 m long) leads to a 34C rise.**
- **Type 4 temperature rise is between ~20 deg C and ~35 deg C with 192 powered cables in the bundle**
- **With Type 4 power levels, small changes in conditions lead to large differences in temperature.**
- **Ethernet (1000BASE-T) operation was not impacted during any test**

Temperature Rise above Ambient For 192 cable bundles in different length conduit sections

“investigating the worse case temperature rise above ambient for a shorter conduit sections”

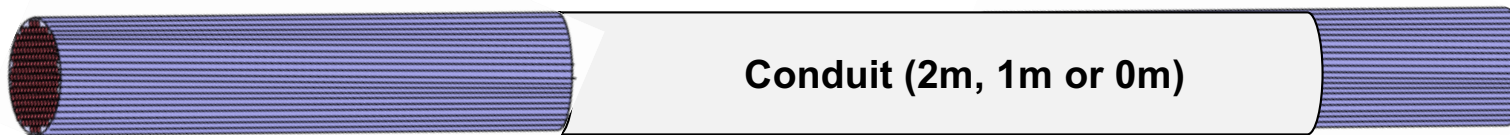

Test Results

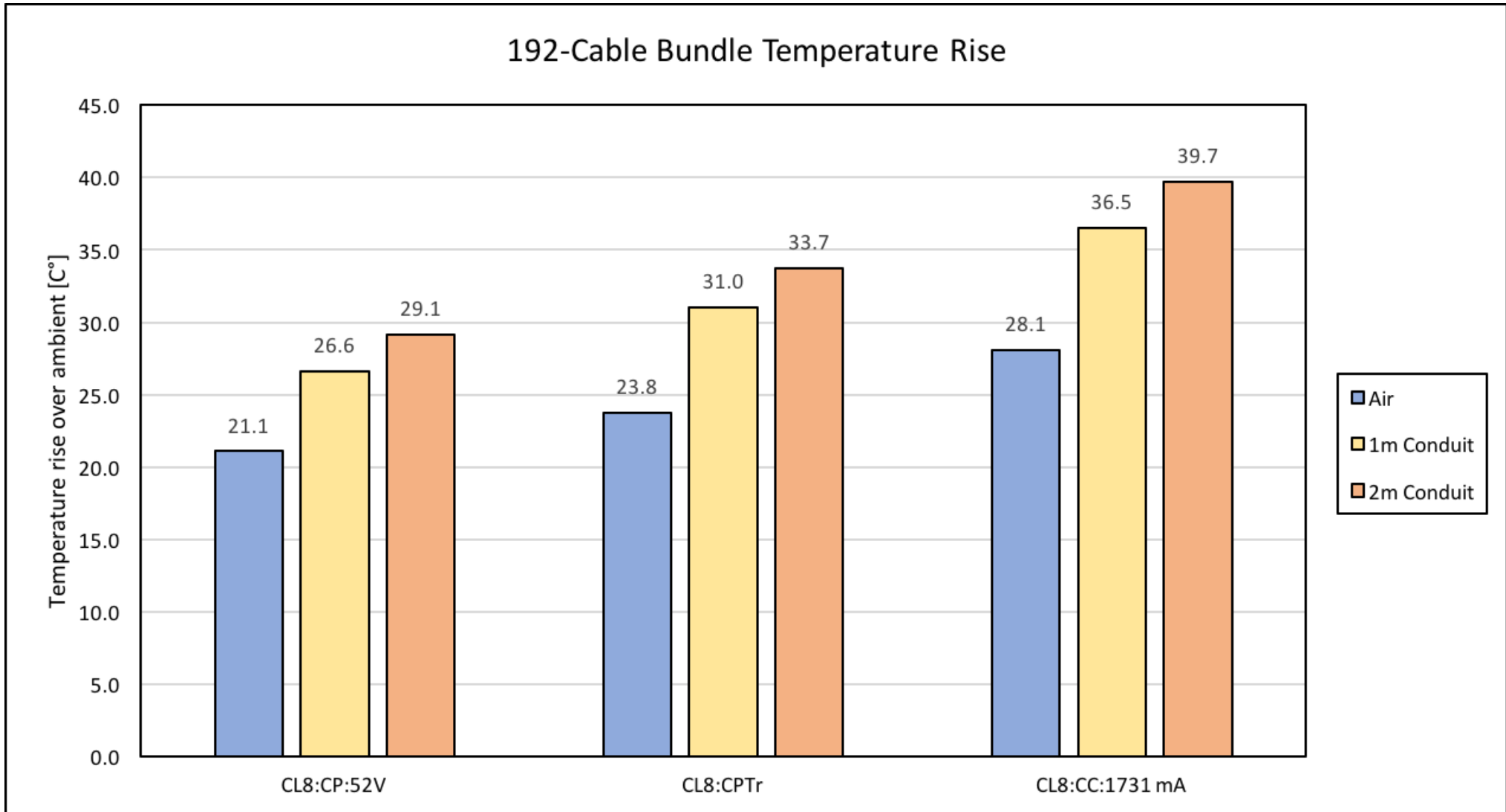

Temperature Rise above Ambient For partially powered cables in a 192 cable bundle

“investigating the worse case temperature rise above ambient for a partially powered bundle and investigating the importance of the positions of these powered cables”

Partially powered bundles (Class 8)

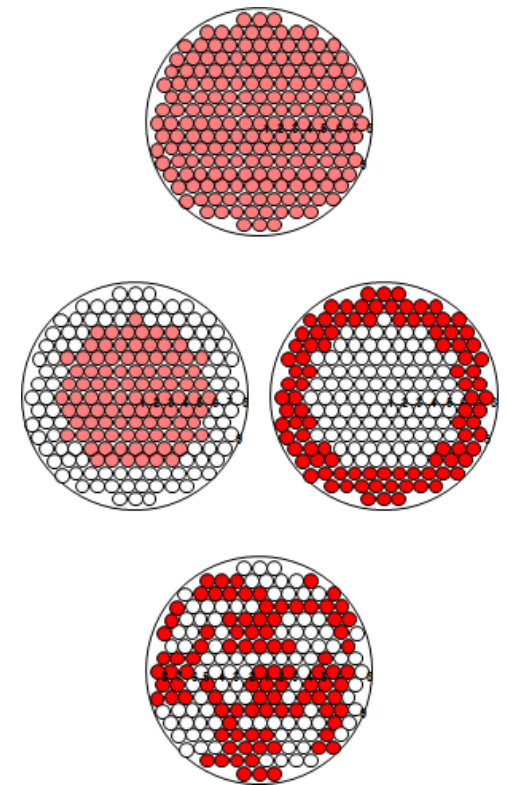
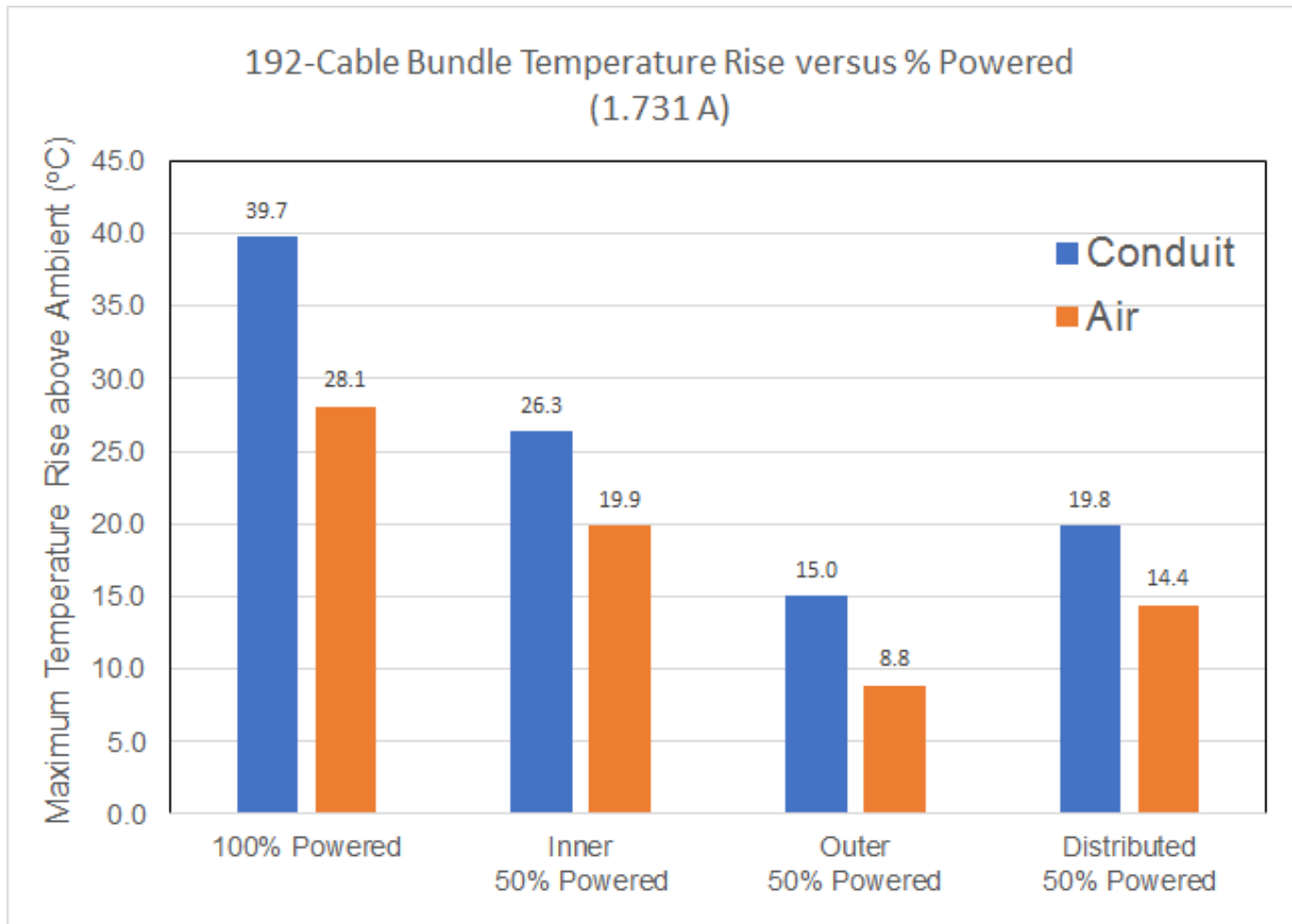

Partially powered bundles (Class 6)

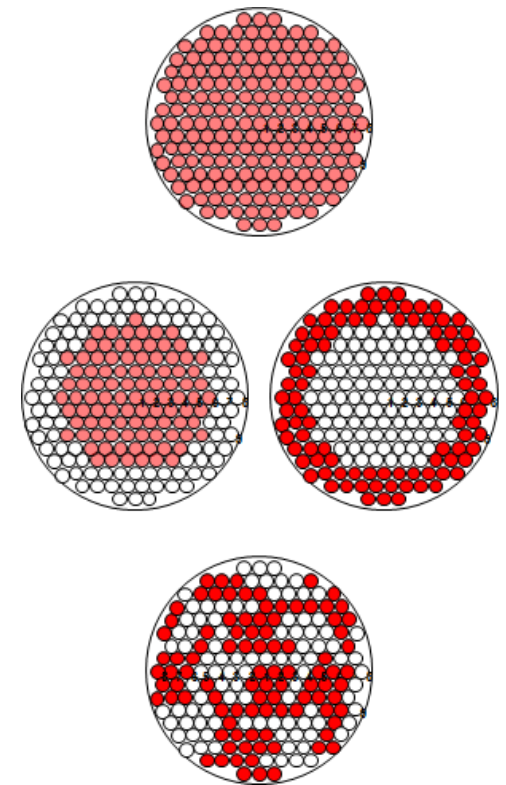
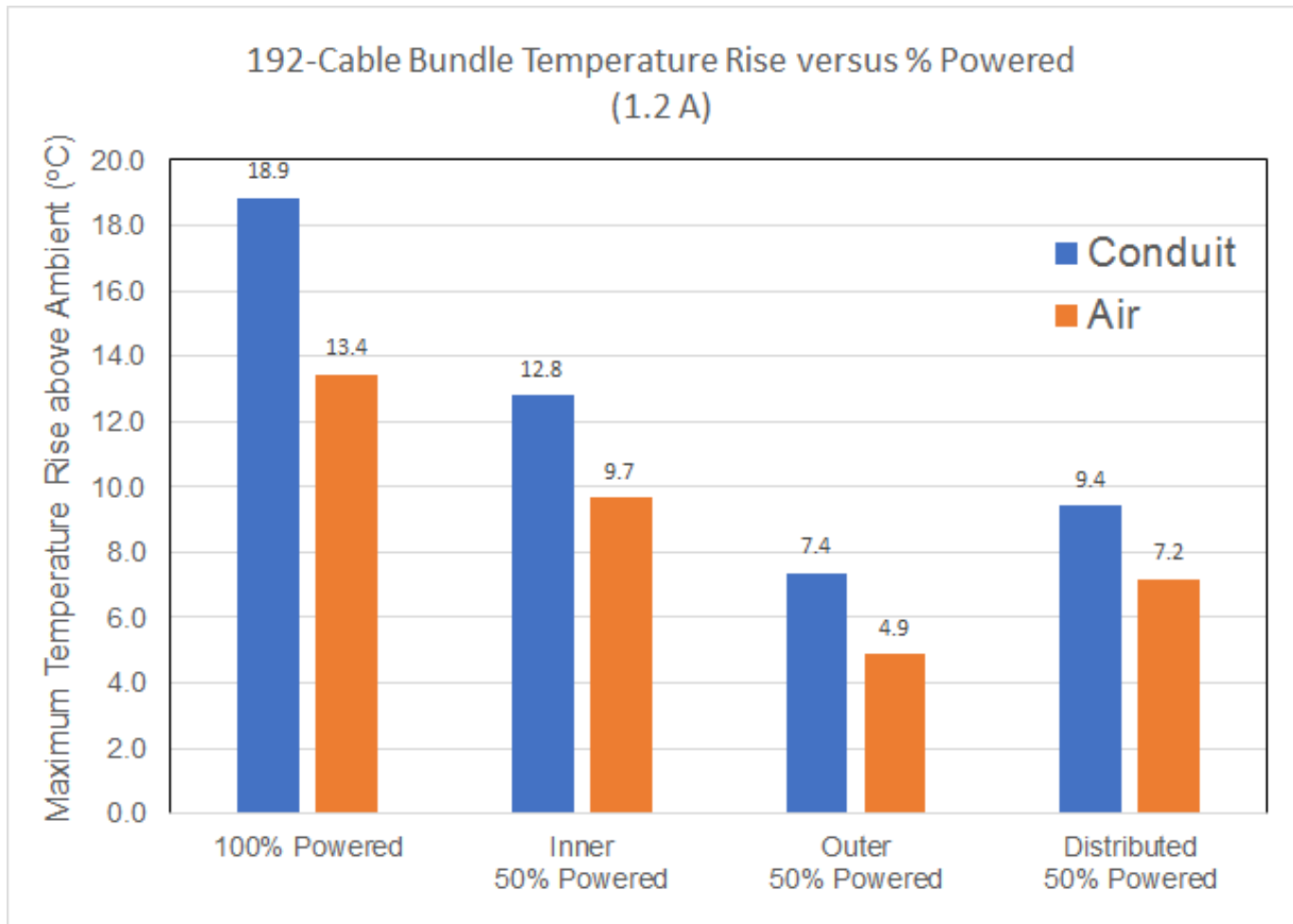

Results

1. **Partial PoE powering within a cable bundle lowers the worst case temperature rise above ambient significantly.**

The magnitude of the reduction in temperature arises from the reduced number of powered cables as well as the position of these powered cables

2. **Corollary: The thermal conductivity of the cable as well how tightly packed the cable bundle is, are important parameters in determining the temperature rise above ambient (because heat flows mostly radially outwards towards the ambient) and hence a close packed cable bundle will have a higher thermal conductivity than a loose packed cable bundle due in part by the amount of air within the cable and between the cables which both form a thermal barrier.**

Temperature Rise above Ambient For smaller Bundle sizes (192, 169, 61, & 37)

“validating the TIA TSB184 Table A.2”

Smaller bundle sizes

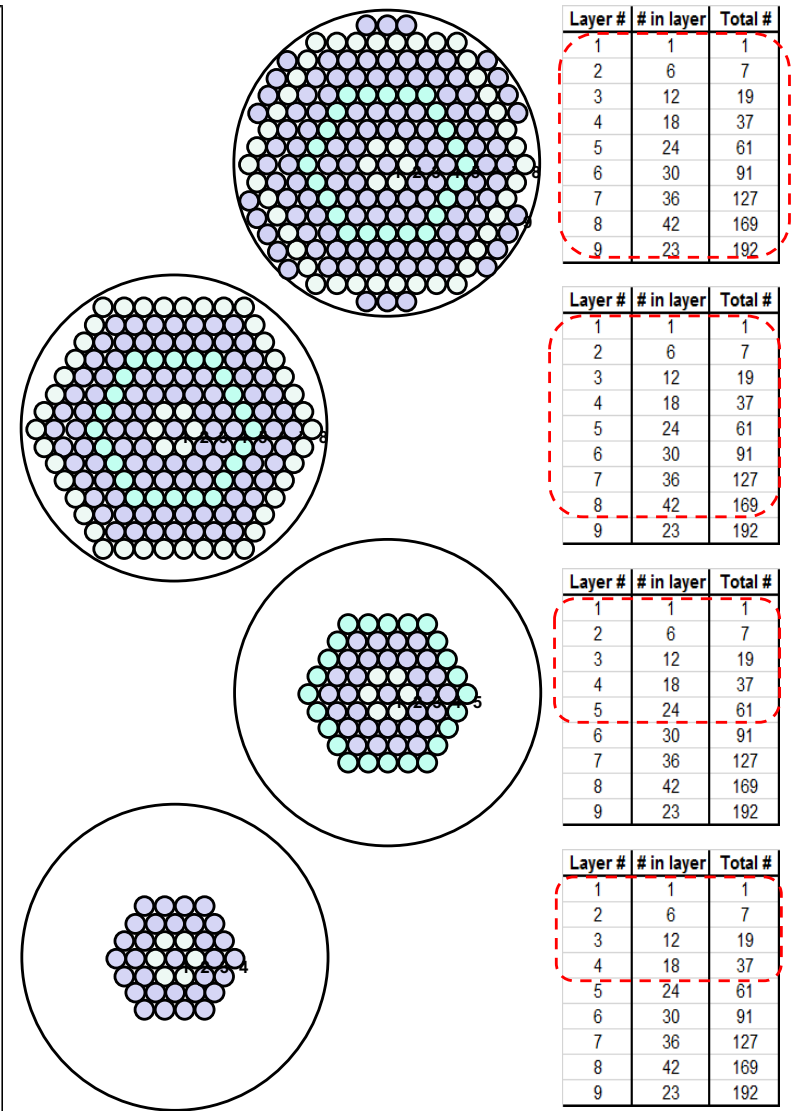
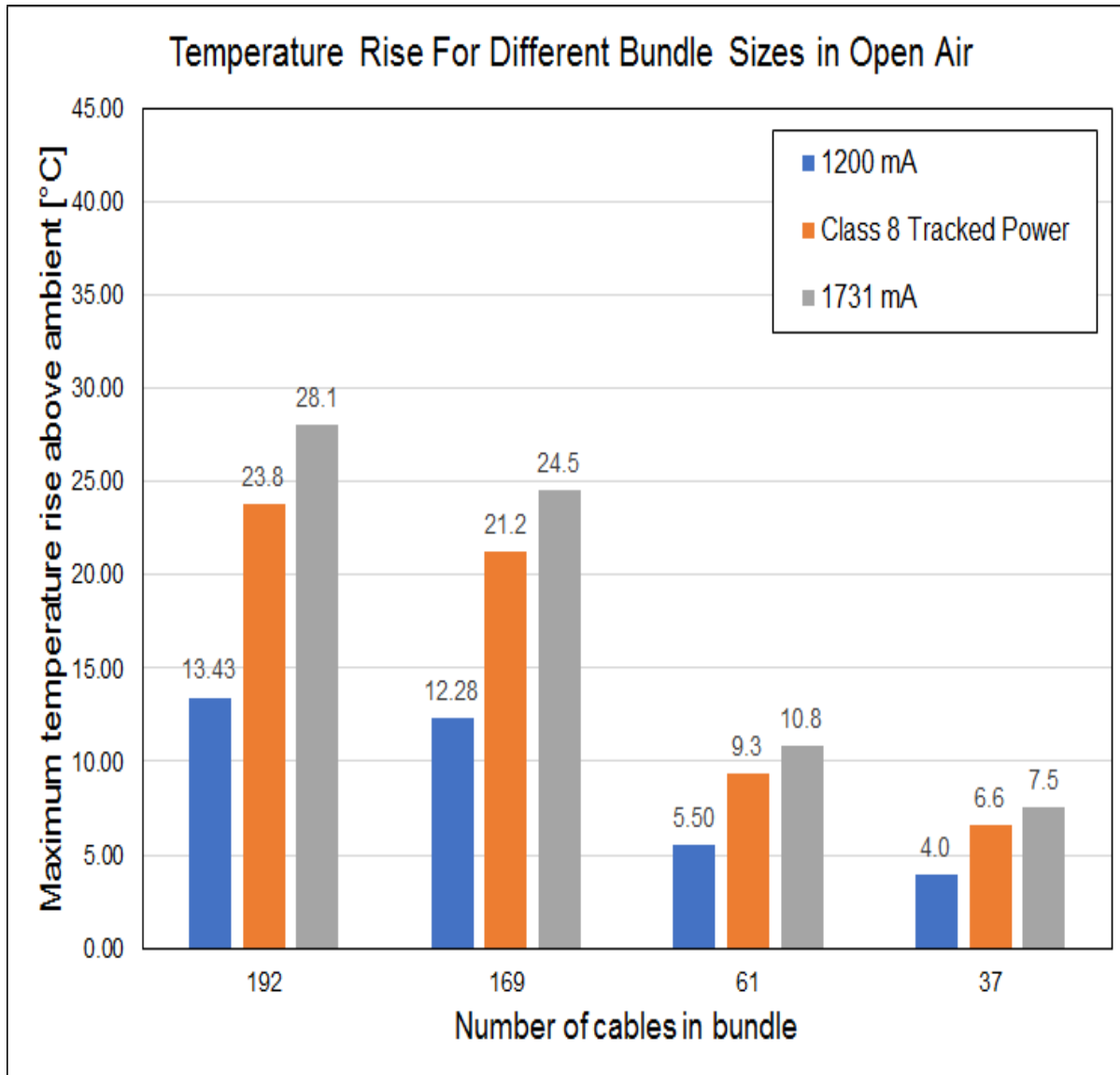

Comparison to TSB-184

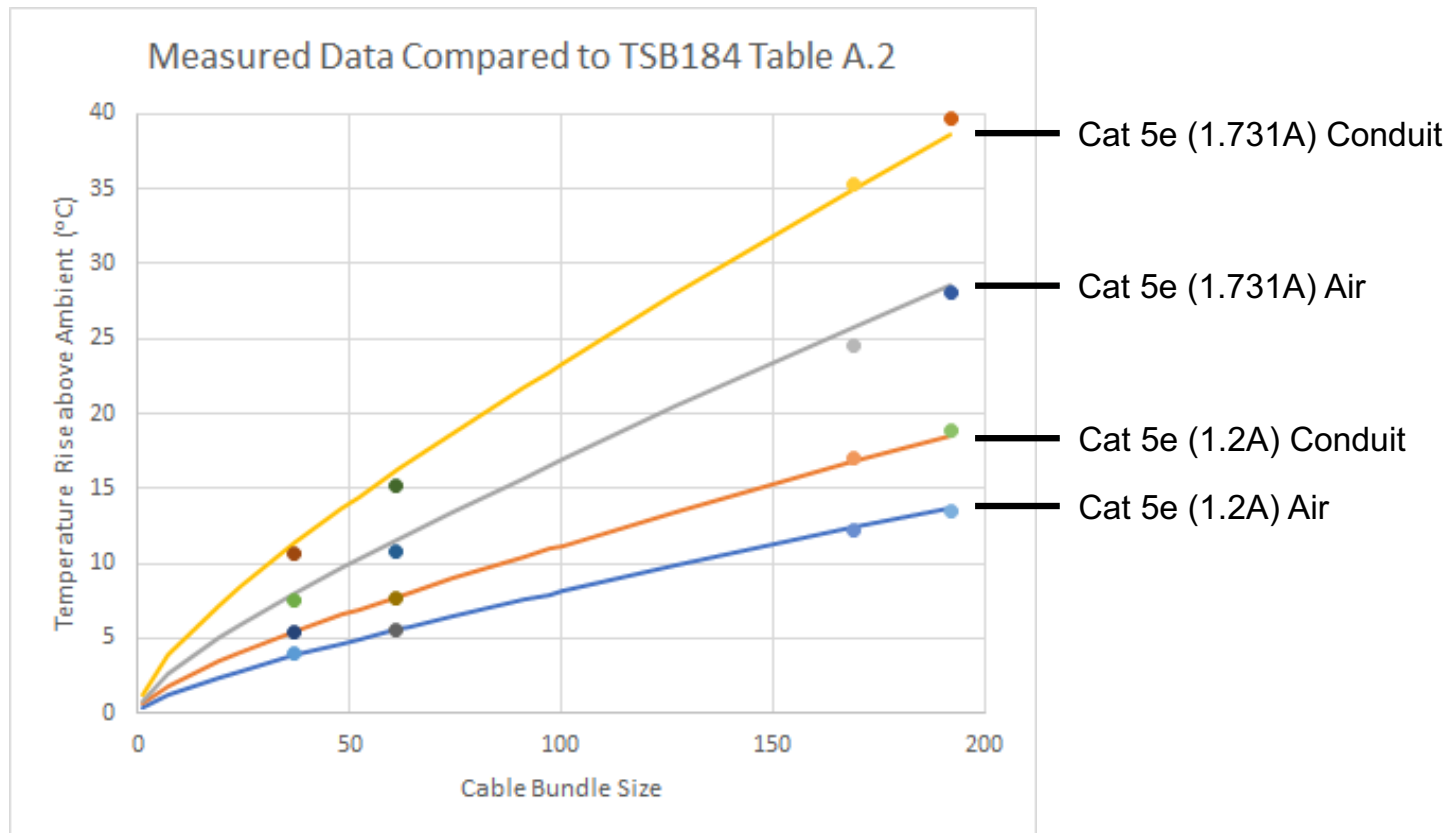

Conclusion

- **The constant power method yields results of real power delivery systems compared with a constant current testing method in assessing the temperature increase in cable bundles.**
- **For high power Type 4 systems, the CC method over-estimated temperature rise by as much as 10 degrees C.**
- **Type 3 power levels (51W PD) has a 17 degree C rise in the extreme corner case. A typical system (192 x CP:54V, 50% powered, conduit), sees a 6.5 degree C rise.**
- **Type 4 power levels (71W PD) has a 33 degree C rise in the extreme corner case. A typical system (192 x CP:55V, 50% powered, conduit), sees a 13 degree C rise.**
- **While Type 3 systems are fine with 192 cable bundles, Type 4 powering requires considerations for usage in 192 cable bundles. Testing shows bundles of 61 lead to 10 deg C rise with all cables full power.**
- **Based on these results we hope to formulate easy to implement and easy to verify recommendations for power delivery and installation practices.**
- **Possibly implemented in an IEEE Annex on “engineered” power delivery.**

Appendix

Test Results

Constant Power Methodology dependence of cable length Distribution

Cable Distribution Type	worse case average current (A)
equal	1.5395
parabolic	1.5493
inv parabolic	1.5308
linear up	1.59
linear dwn	1.4755
square up	1.6075
square down	1.4623
Chi square distr	1.4993
inv Chi square distr	1.462
Consortium Distrib	1.5058
Constant Current	1.731

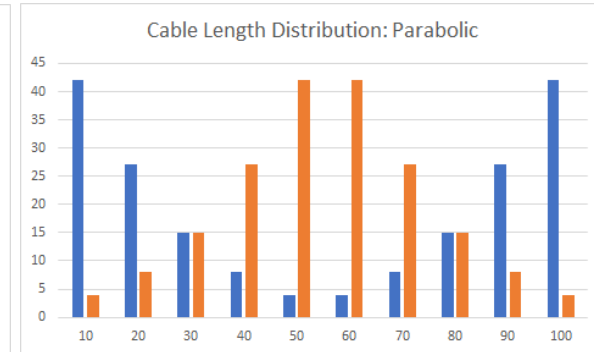
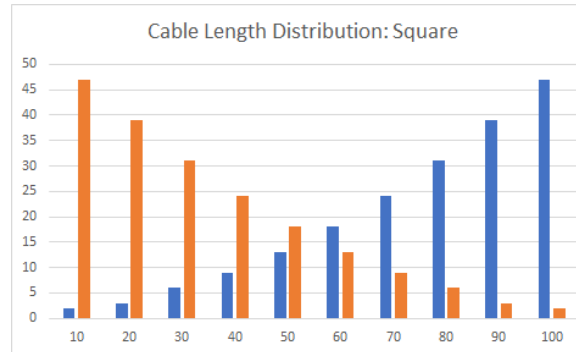
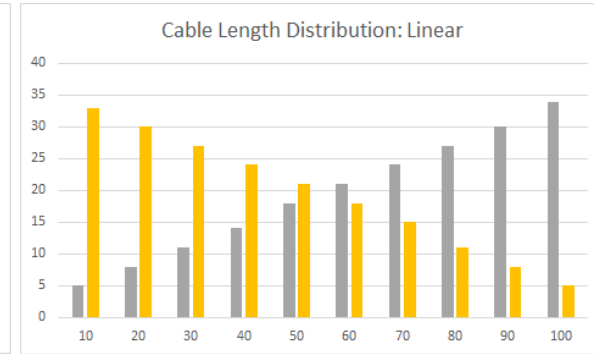
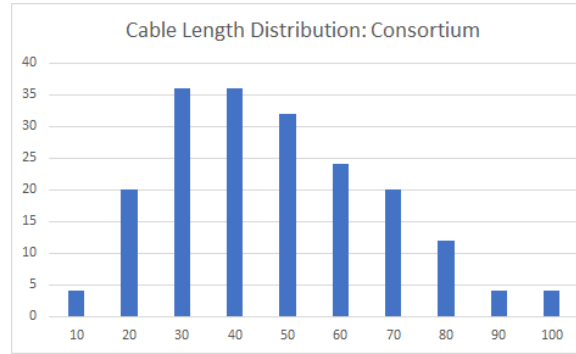

Summary:

The consortium cable length distribution is very similar to a Chi Square distribution (a widely used distribution) and best represents a practical cable installation. Note that the average current calculated from these various distributions are all very close to the consortium distribution used in this presentation (mean = 1.524 A with standard deviation = 0.0534 A). Hence not very sensitive to the distribution type used.

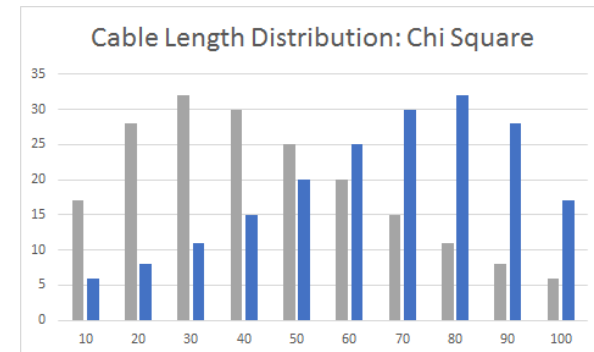

Test Results

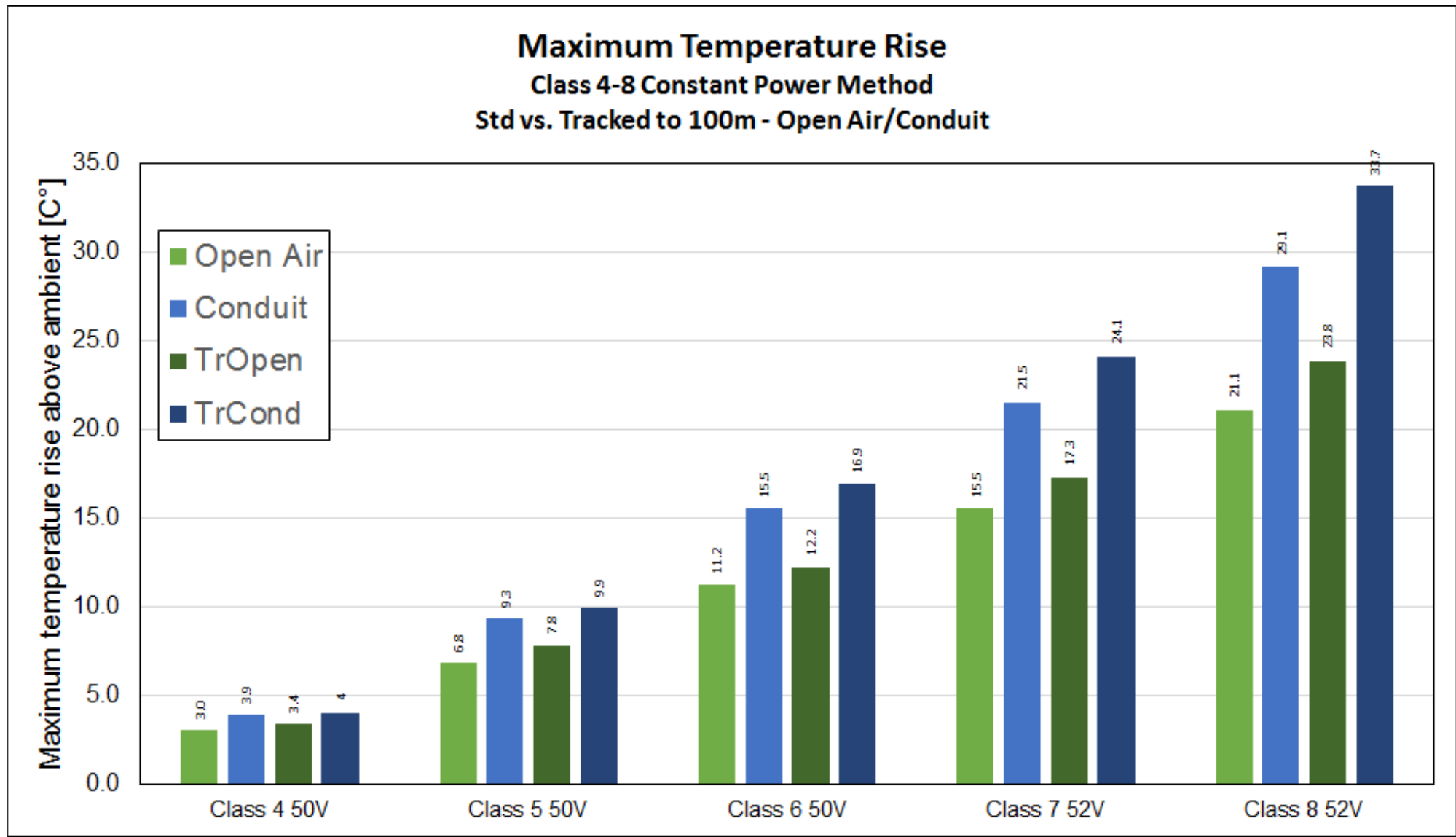

Temperature rise vs cable length (ambient)

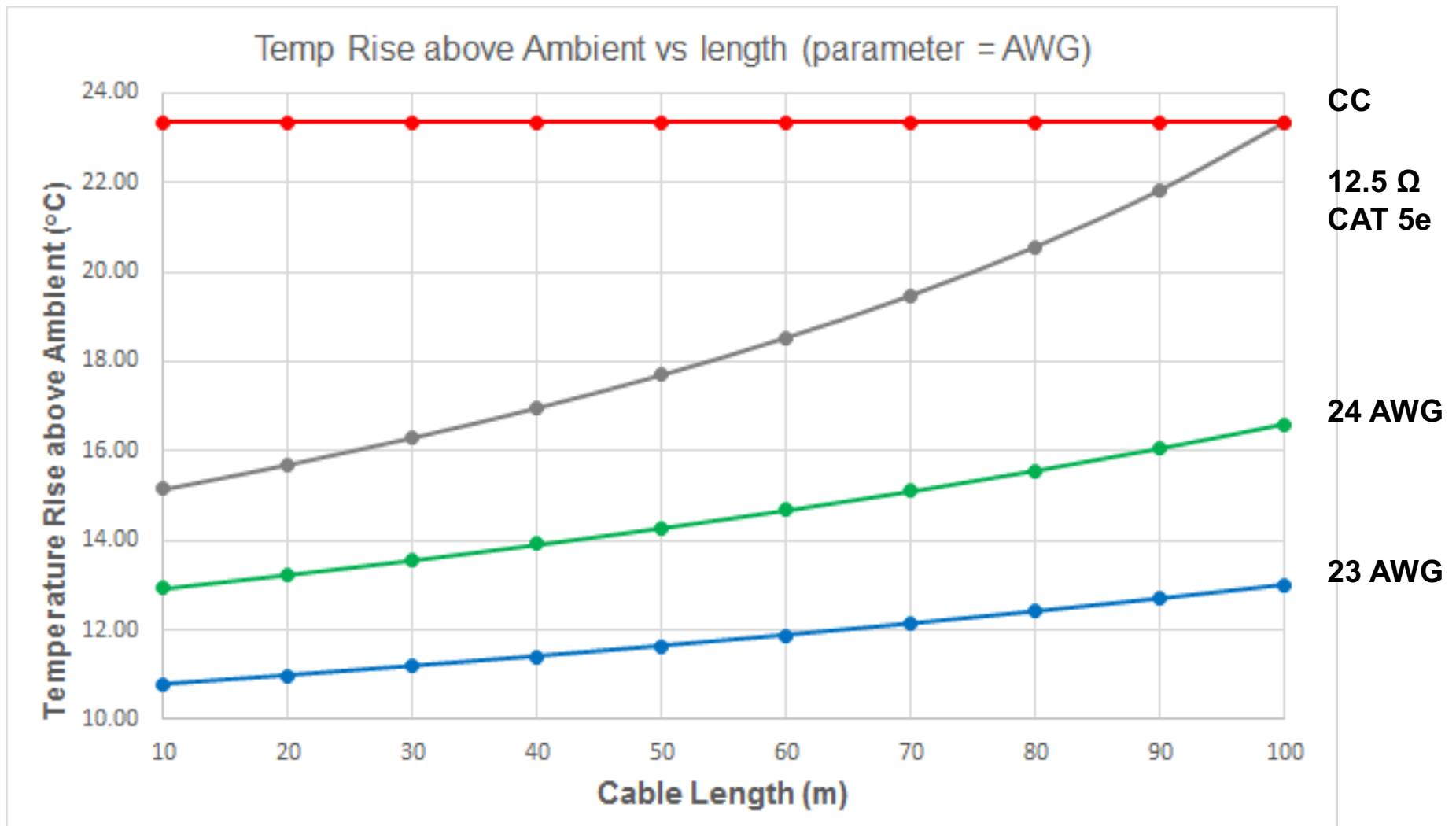

Temperature rise vs cable length (conduit)

