

Project	<b>IEEE 802 Executive Committee Study Group on TV White Spaces</b>
Title	<b>TV Whitespace Tutorial Intro</b>
Date Submitted	<b>March 10, 2009</b>
Source(s)	Contributor: Matthew Sherman, Affiliation – BAE Systems Voice: +1 973 633 6344, e-mail: <a href="mailto:matthew.sherman@baesystems.com">matthew.sherman@baesystems.com</a>
Abstract	TV White Space Tutorial Intro
Purpose	To help the 802 Community understand the opportunity and organize to capture its full potential
Release	The contributor grants a free, irrevocable license to the IEEE to incorporate material contained in this contribution, and any modifications thereof, in the creation of an IEEE Standards publication; to copyright in the IEEE's name any IEEE Standards publication even though it may include portions of this contribution; and at the IEEE's sole discretion to permit others to reproduce in whole or in part the resulting IEEE Standards publication. The contributor also acknowledges and accepts that this contribution may be made public by IEEE 802.
Patent Policy and Procedures	The contributor is familiar with the IEEE-SA Patent Policy and Procedures: < <a href="http://standards.ieee.org/guides/bylaws/sect6-7.html#6">http://standards.ieee.org/guides/bylaws/sect6-7.html#6</a> > and < <a href="http://standards.ieee.org/guides/opman/sect6.html#6.3">http://standards.ieee.org/guides/opman/sect6.html#6.3</a> >. Further information is located at < <a href="http://standards.ieee.org/board/pat/pat-material.html">http://standards.ieee.org/board/pat/pat-material.html</a> > and < <a href="http://standards.ieee.org/board/pat">http://standards.ieee.org/board/pat</a> >.

# AGENDA

1.00	WELCOME / INTRODUCTIONS / RECOMMENDATIONS	Sherman	5	06:30 PM
2.00	US AND NON-US REGULATORY ENVIRONMENT	Rayment	30	06:35 PM
3.00	USE CASES FOR TV WHITESPACE	Cummings	10	07:05 PM
4.00	COEXISTANCE BETWEEN 802 STANDARDS IN TV WHITESPACE	Shellhammer	15	07:15 PM
5.00	COMMON FUNCTIONS ACROSS 802 FOR TV WHITESPACE	-	0	07:30 PM
5.01	COMMON FUNCTIONS ACROSS 802 FOR TV WHITESPACE	Paine	5	07:30 PM
5.02	COMMON FUNCTIONS ACROSS 802 FOR TV WHITESPACE	Goldhamer	10	07:35 PM
6.00	QUESTIONS AND ANSWERS	Sherman	15	07:45 PM
7.00	SECURITY FOR TV WHITESPACE	Reznik	10	08:00 PM
8.00	STANDARDS ACTIVITIES RELATING TO TV WHITESPACE	-	0	08:10 PM
9.00	IEEE 802.22 (Pending)	Chouinard	10	08:10 PM
10.00	IEEE SCC 41 (Pending)	Harada	10	08:20 PM
11.00	ITU / ETSI (09/47)	Sherman	10	08:30 PM
12.00	SDR FORUM (09/50)	Pucker	10	08:40 PM
13.00	QUESTIONS AND ANSWERS	Sherman	10	08:50 PM
14	Recess Meeting	Sherman		09:00 PM

# The TV Whitespace ECSG

- Recent FCC R&O on Unlicensed use of 'TV Whitespace' has created extensive interest across IEEE 802
- IEEE 802 charted the TV Whitespace ECSG to study key issues for operating in this band
  - Different from other Unlicensed Bands!
- Primary response to EC is via the TV Whitespace Tutorial

# What is TV Whitespace?

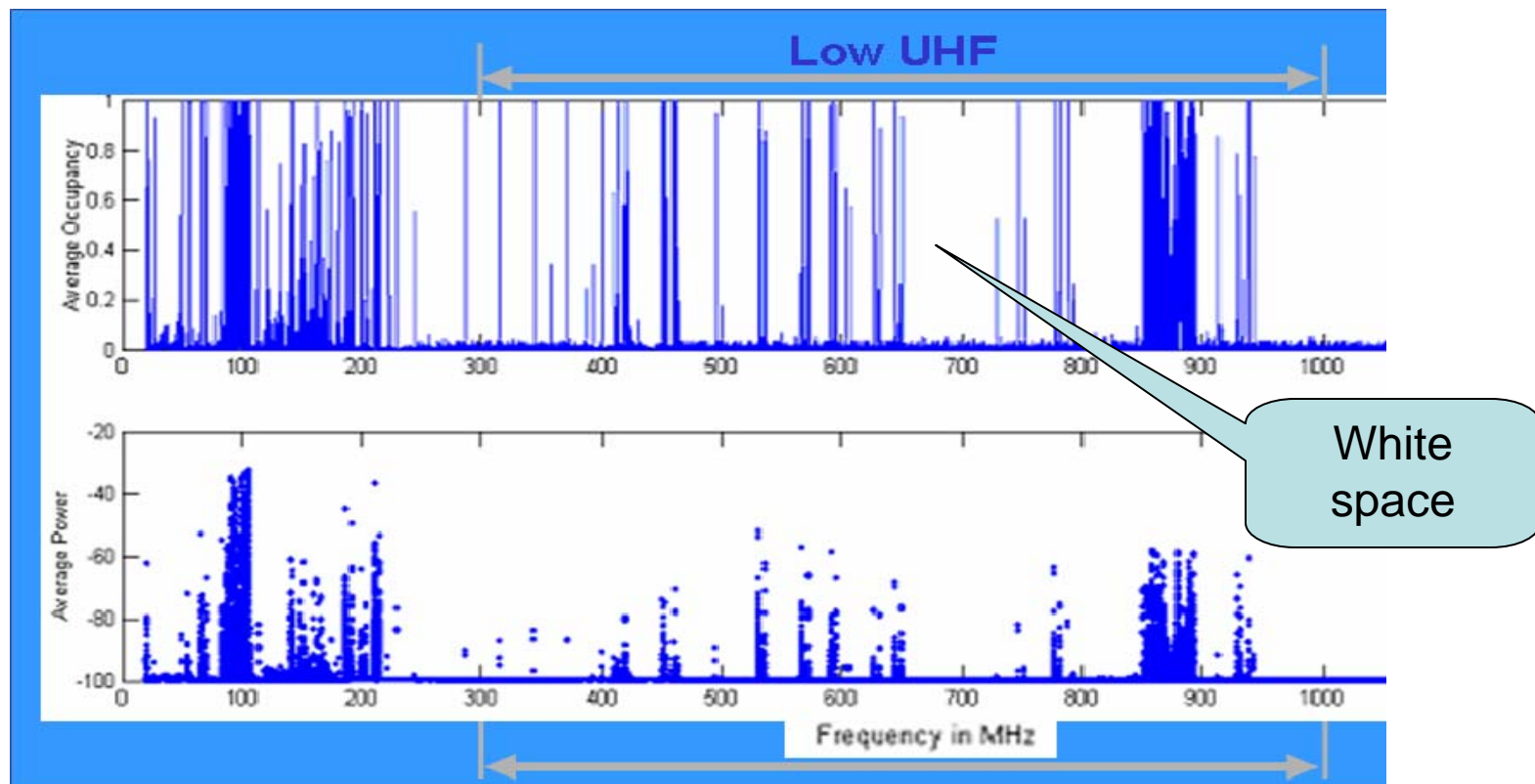

***(Test conducted in the rural sector west of Ottawa, Canada)\****

\*- C. R. Stevenson, G. Chouinard, W. Caldwell, Tutorial on the P802.22.2 PAR for :“Recommended Practice for the Installation and Deployment of IEEE 802.22 Systems,” IEEE802, San Diego, CA, 7/17/06  
[http://grouper.ieee.org/groups/802/802\\_tutorials/july06/Rec-Practice\\_802.22\\_Tutorial.ppt](http://grouper.ieee.org/groups/802/802_tutorials/july06/Rec-Practice_802.22_Tutorial.ppt)

## Current Recommendations to 802 for next steps

- Currently approved recommendations include
  - The ECSG recommends that IEEE 802 standards operating in the TV Whitespace seeks to support techniques that protect information from the database.
  - The ECSG recommends that IEEE 802 have a coordinated approach (across all WG) to standards in TV Whitespace.
  - The ECSG recommends that IEEE 802 foster cooperation between species of 802 devices in TV Whitespace spectrum.
  - The ECSG recommends that IEEE 802 establish White Space liaisons as necessary with other SDOs.
  - The ECSG recommends that the EC consider the content of document 09/51r2 in response to its questions on Use Cases for TV Whitespace spectrum. (Paraphrased)

# Regulatory Tutorial Material

Date: 2009-03-10

Authors:

Name	Company	Address	Phone	E-mail
Stephen G. Rayment	BelAir Networks	603 March Road Kanata, ON, Canada K2K 2M5	+1 613 254 7070	<a href="mailto:srayment@belairnetworks.com">srayment@belairnetworks.com</a>
Peter Eccelsine	Cisco Systems	170 W. Tasman Drive San Jose, CA, USA 95134-1706	+1 408 527 0815	<a href="mailto:petere@cisco.com">petere@cisco.com</a>
Gerald Chouinard	Communication Research Centre Canada	3701 Carling Avenue Ottawa, ON, Canada K2H 8S2	+1 613 998 2500	<a href="mailto:gerald.chouinard@crc.ca">gerald.chouinard@crc.ca</a>
Dan Lubar	RelayServices	4450 Arapahoe Ave, Suite 100 Boulder, CO, USA 80303	+1 877 569 5069	<a href="mailto:dlubar@relayservices.com">dlubar@relayservices.com</a>
Michael Christensen	Industry Canada	Ottawa, ON, Canada K1A 0C8	+1-613-990-4792	<a href="mailto:michael.christensen@ic.gc.ca">michael.christensen@ic.gc.ca</a>
Mark Austin	Ofcom	Riverside House 2a Southwark Bridge Road London, UK SE1 9HA	+44 (0)20 7783 4364	<a href="mailto:mark.austin@ofcom.org.uk">mark.austin@ofcom.org.uk</a>
Maximilian Sandmann	Vondel O.G.	Overtoom 241 1054HV Amsterdam, the Netherlands	+31 6 41 1000 40	<a href="mailto:maximilian@vondelog.com">maximilian@vondelog.com</a>

**Notice:** This document has been prepared to assist IEEE ECSG on TV White Space. It is offered as a basis for discussion and is not binding on the contributing individual(s) or organization(s). The material in this document is subject to change in form and content after further study. The contributor(s) reserve(s) the right to add, amend or withdraw material contained herein.

**Release:** The contributor grants a free, irrevocable license to the IEEE to incorporate material contained in this contribution, and any modifications thereof, in the creation of an IEEE Standards publication; to copyright in the IEEE's name any IEEE Standards publication even though it may include portions of this contribution; and at the IEEE's sole discretion to permit others to reproduce in whole or in part the resulting IEEE Standards publication. The contributor also acknowledges and accepts that this contribution may be made public by IEEE 802.

**Patent Policy and Procedures:** The contributor is familiar with the IEEE 802 Patent Policy and Procedures <<http://iee802.org/guides/bylaws/sb-bylaws.pdf>>, including the statement "IEEE standards may include the known use of patent(s), including patent applications, provided the IEEE receives assurance from the patent holder or applicant with respect to patents essential for compliance with both mandatory and optional portions of the standard." Early disclosure to the TAG of patent information that might be relevant to the standard is essential to reduce the possibility for delays in the development process and increase the likelihood that the draft publication will be approved for publication. Please notify the Chair <[matthew.sherman@baesystems.com](mailto:matthew.sherman@baesystems.com)> as early as possible, in written or electronic form, if patented technology (or technology under patent application) might be incorporated into a draft standard being developed within the IEEE. If you have questions, contact the IEEE Patent Committee Administrator at <[patcom@ieee.org](mailto:patcom@ieee.org)>.

# Summary

- **Introduction**
- **FCC Report & Order**
- **Industry Canada**
- **Ofcom**
- **Netherlands Antilles**

## TV White Space (TVWS) - What is it?

- **Unused television channels caused by analog TV non-use or separation distances**
  - 4 contiguous blocks – total 418MHz
    - 2-6: 54-72MHz, 76-88MHz ( $\lambda$  about 6 meters)
    - 7-13: 174-216MHz
    - 14-20: 470-512MHz
    - 21-36: 512-608MHz
    - 37-51: 608-698MHz ( $\lambda$  about 60 cm)
    - 52-69: 698-806MHz (re-allocated in the “700MHz” auctions)
  - 6MHz channels
  - Channel 37 is reserved for radio astronomy and medical telemetry
  - Some of channels 14-20 are shared with Land Mobile Systems in 13 urban markets
- **Amount available will increase with DTV Transition on ~~February 17~~ June 12 2009 to DTV (August 2011 in Canada)**
  - No more “double” analog / digital broadcasts
  - Relaxed separation distance requirements for DTV
  - Possible compression
  - Note: only full power stations will transition (~1800 vs 7100 others)



## US Broadband Infrastructure Situation

- **American Recovery & Reinvestment Act (ARRA) stimulus funding is now law**
- **A total of US\$7.2 billion of ARRA Stimulus funds have been allocated to Broadband Infrastructure (in the form of direct grants, loans, or loan guarantees)**
  - Focus on rural and/or “un-served” & “under served” areas
- **US\$4.7 billion managed by NTIA BTOP (Broadband Technology Opportunity Program)**
  - NTIA/BTOP funds must be disbursed by Sept 30<sup>th</sup> 2010
- **US\$2.5 billion added to Dept of Agriculture’s existing RUS (Rural Utilities Service) program**
  - RUS funds must be disbursed by Sept 30<sup>th</sup> 2009
- **“Call to Action” by US Broadband Coalition**
  - Wide support for a call for comprehensive US “National Broadband Strategy” - see <http://bb4us.net/>
  - Concerns over international competitiveness and broadband uptake linkage (OECD studies)
  - Targeting specific policy recommendations Spring 2009

## Who was involved with FCC so far?

- **Google, Dell, Motorola, Intel and Philips – over past ~ 4 years**
- **Huge lobbying effort created real challenge for regulators!**
  - Incumbent TV broadcast and wireless microphones: Dolly Parton, Neil Diamond, the Dixie Chicks, Clay Aiken, Guns N' Roses, pastor Joel Osteen
  - vs
  - New “innovative use” Internet applications: Larry Page, Bill Gates, Michael Dell
- **18 months of FCC OET testing**
  - Shure (microphones)
  - vs
  - Motorola, Philips, Microsoft, Adaptrum, Infocomm prototypes
  - Concluded geo-location is required as well as sensing
- **White Space Coalition**
  - FCC advocacy group
- **Wireless Innovation Alliance**
  - Market facing group

## White Spaces Database Group

- **Formed February 2008 to facilitate the timely creation and operation of a white spaces database**
- **Founding members of the White Spaces Database Group include Comsearch, Dell, Google Inc., HP, Microsoft Corporation, Motorola Inc., and NeuStar**
- **Establish data formats and protocols that are open and non-proprietary**
- **Advocate that database administration be open and non-exclusive**

<http://finance.yahoo.com/news/Tech-Industry-Leaders-Join-to-bw-14249612.html>

# Summary

- Introduction
- **FCC Report & Order**
- Industry Canada
- Ofcom
- Netherlands Antilles

# FCC Report and Order 08-260

Adopted: Tuesday November 4, 2008 (familiar date?!)

Federal Register: February 18, 2009 Reconsideration Period ends: March 19, 2009

- **Unlicensed “Part 15” operation! (15.700)**
- **Allows fixed and personal / portable broadband devices – TV Band Devices “TVBD’s”**
- **Fixed devices must include geo-location and query a database to determine allowed channels**
- **Two classes of (Wi-Fi-like) portable devices:**
  - Mode I – under control of a device that employs geo-location / database access
  - Mode II – employ geo-location / database access itself
- **Database operated by a third party**
- **All devices must also include spectrum sensing capability to identify TV and wireless microphone signals**
- **Devices will be type approved, initially certified by FCC Laboratory**
- **FCC reserves right to approve devices without geo-location /database to “much more rigorous” test open to the public**
- **Effective after DTV Transition – June 12, 2009**

Initial NOI December 2002

NPRM 2004

# Database

- **Geo-location & database access**
  - Must be supported in both Fixed and Portable Mode II devices
  - Accuracy of  $\pm 50$  meters
  - Could be GPS or “Professional Installation”
- **National databases of TV bands**
  - Identify available TV channels at the TVBD’s location
  - Register ID and location of fixed TVBDs
  - Identify other protected locations and channels
- **Fixed device’s ID information includes:**
  - FCC ID, serial number, location, contacts, etc.
- **FCC will certify the official databases and designate one or more administrators**
  - Administrators may charge a fee
- **Fixed devices must consult database on initialization and daily**
  - Operation must cease immediately if channel no longer available
  - Fixed devices without a direct Internet connection may communicate with another connected fixed device on a channel it has OK’d
- **Mode II devices must additionally consult after being re-located and daily**

## Key RF Parameters

- **Fixed Devices**
  - 1W Tx power / 4W EIRP (max)
  - VHF + UHF TV channels 2, 5-36, 38-51 nationwide (282 MHz)
  - If on adjacent channel - power limit is 40mW
  - Must sense signals to -114 dBm
- **Personal / Portable Devices**
  - 100mW EIRP
  - UHF TV channels 21-36, 38-51 nationwide (180 MHz)
  - Must sense signals to -114 dBm
  - 50mW EIRP if device uses spectrum sensing only
- **Strict Out-of-Band Emissions**
  - In the adjacent channel must be 55dB below the “highest average power” in the channel in which the device is operating
  - More stringent at edges of channels 36 and 38
- **Devices must include adaptive power control**
- **Fixed devices shall transmit identifying information**
  - Device ID and co-ordinates

# Contours, Separation and Antennas

Type of station	Protected contour		
	Channel	Contour (dBuV)	Propagation curve
Analog: Class A TV, LPTV, translator and booster	Low VHF (2-6)	47	F(50,50)
	High VHF (7-13)	56	F(50,50)
	UHF (14-69)	64	F(50,50)
Digital: Full service TV, Class A TV, LPTV, translator and booster	Low VHF (2-6)	28	F(50,90)
	High VHF (7-13)	36	F(50,90)
	UHF (14-51)	41	F(50,90)

Antenna Height of Unlicensed Device	Required Separation (km) From Digital or Analog TV (Full Service or Low Power) Protected Contour	
	Co-channel	Adjacent Channel
Less than 3 meters	6.0 km	0.1 km
3 – Less than 10 meters	8.0 km	0.1 km
10 – 30 meters	14.4 km	0.74 km

- Receive antennas used with fixed devices shall be located outdoors at least 10m above the ground
- Transmit antennas used with fixed devices may not be more than 30m above the ground
- Personal / portable device antennas shall be permanently attached and comply at height less than 3m



## Spectrum Sensing

- **Must be supported in all devices**
- **ATSC and NTSC TV signals**
- **Wireless microphones**
  - ENG (Electronic News Gathering) – Part 74
  - Other adjacent bands (eg. churches!) – Part 90.267
- **Sensing down to -114 dBm**
  - ATSC signals: -114 dBm, averaged over a 6 MHz bandwidth
  - NTSC signals: -114 dBm, averaged over a 100 kHz bandwidth
  - Wireless microphone signals: -114 dBm, averaged over a 200 kHz bandwidth
- **FCC will consider (50mW) “sensing-only” devices but with much more stringent testing required**

# Analog TV (NTSC) Spectrum

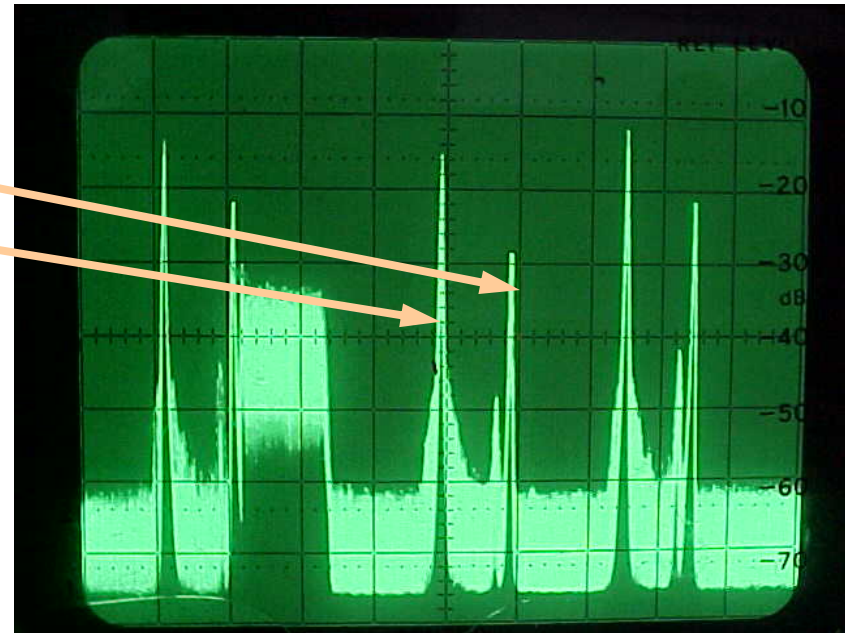
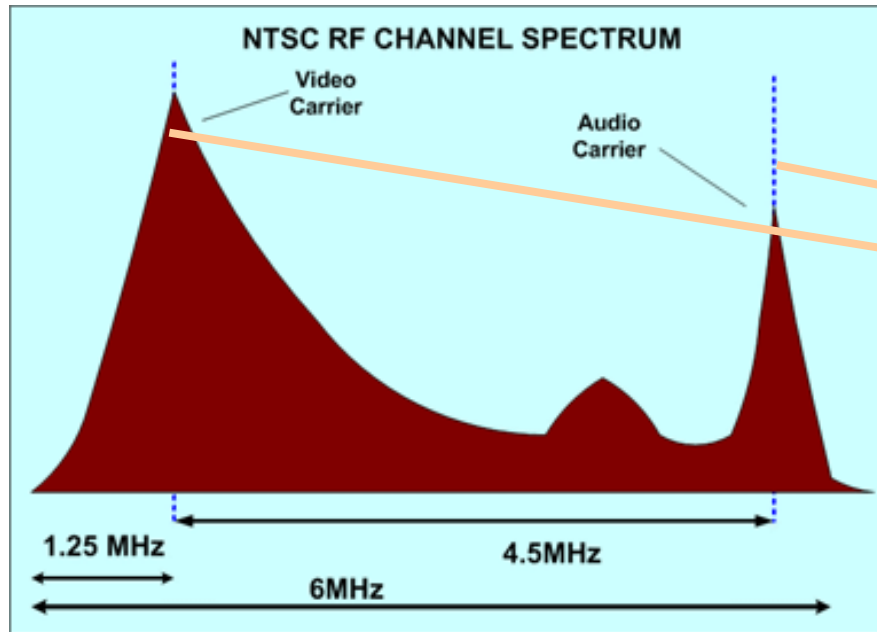

- Power primarily confined to Video and Audio carriers
- Distinctive double peaked spectrum makes identification by spectrum profiling relatively easy
- Relatively high narrowband power levels compared to DTV

# Digital TV (ATSC) Spectrum

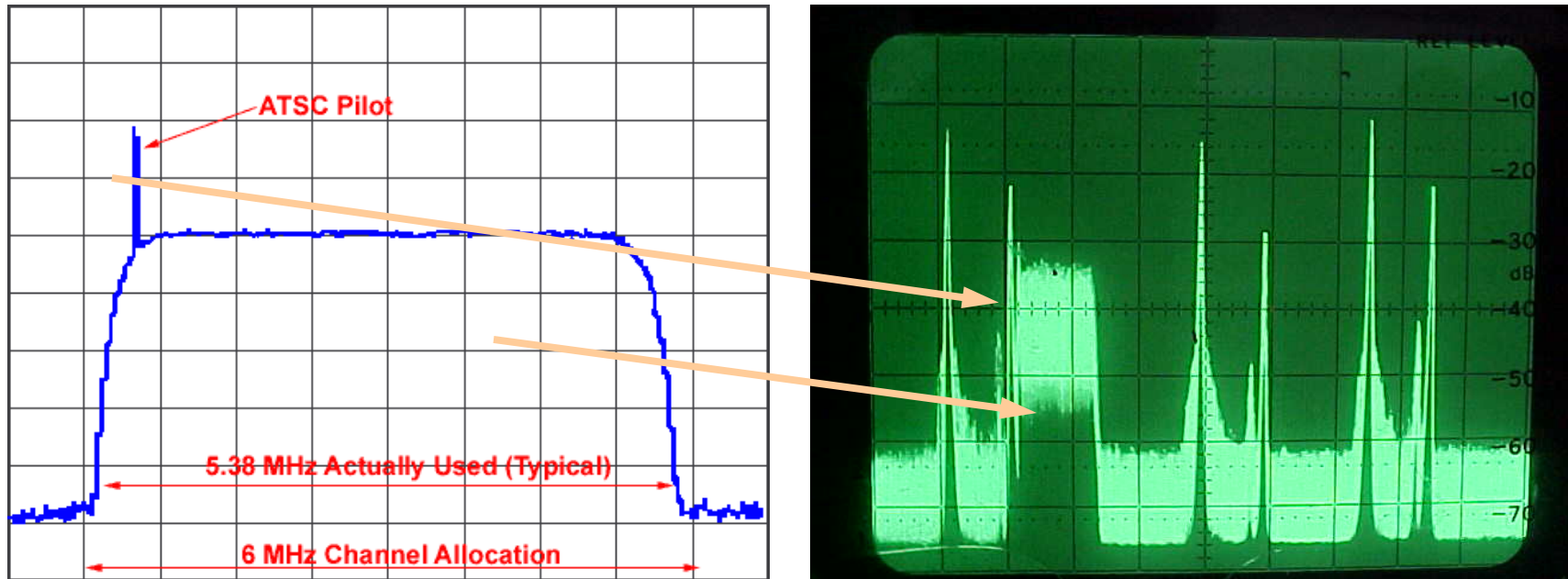

- Power spread over centre 5.38 MHz within a TV channel
- Pilot tone is a distinctive feature when observed in a narrowband receiver
- Pilot tone power is 11.3 dB below average power measured in a 6 MHz bandwidth

## Wireless Microphones

**Must be protected through:**

- **Database entry**
- **Sensing at -114dBm**
- **2 channels between 21 and 51 will be reserved**

## IEEE 802.11 input to 802.18

1. Allow a Mode II master device to sense for Mode I client devices, when it can receive messaging from the TV bands database for itself and client devices operating under its control
  - DFS rules for the 5GHz band allow for one or a few sensing devices that communicate with all RLANs in the building
2. The rules for personal/portable Mode I client devices should be changed to remove sensing requirements when operating under control of a master device
3. Wireless microphone licensees must enter geo-location information in the database and require that TVBDs receive relevant database updates from the Internet
  - impossible to sense if a wireless microphone is Part 74 licensed or unlicensed !
  - most microphones today do not enjoy protection
4. RF Emissions Masks in paragraph 15.709(c)(1) should be clarified to indicate that the 55dBr in channels adjacent to the operating channel refers to the average total power over the operating channel:
  - (1) On adjacent channels to the TVBD, its emissions in a 100 kHz measurement shall be at least 39 dB below the average total power over the operating channel

## IEEE 802.22 input to 802.18

1. Fixed devices (base stations) should be allowed to have multiple fixed client /slave devices rather than:
  - "A fixed device may not operate as a client to another fixed device."
2. Sensing for television signals should not be mandated by the Commission
3. Fixed Base Station height should be based on HAAT (Height Above Average Terrain) rather than AGL (Above Ground Level) and not be limited to 30m AGL
4. PSD limits and minimum occupied bandwidth should be specified
  - Maximum EIRP: 4 Watt in 6 MHz, 100 mW in 100 kHz
  - Minimum bandwidth: 500 kHz to differentiate TVBD transmissions from wireless microphones
5. RF mask should be defined relative to the total power in 6 MHz rather than to the in-channel PSD in the reference 100 kHz measurement bandwidth
  - To avoid increase of PSD level in adjacent channels when transmission power is concentrated in a narrower bandwidth  
eg. 72.8 dBc adjacent channel rejection in 100 kHz rather than 55 dB as found in the R&O
6. The sensing threshold for wireless microphones should be -107 dBm rather than -114 dBm
7. Part 74 devices need to be sensed within 2 seconds, not 60 seconds
8. Synchronized quiet periods are necessary for incumbent sensing
  - All TVBDs in an area must observe synchronous quiet periods to allow sensing of Part 74 devices that otherwise would be masked by other nearby TVBDs' operation.

# Summary

- Introduction
- FCC Report & Order
- **Industry Canada**
- Ofcom
- Netherlands Antilles

# Canada's Approach

## The Remote Rural Broadband Service (RRBS)

- Canada has made available a licensed based approach to deliver Remote Rural Broadband Services
  - Interim guidelines: <http://www.ic.gc.ca/epic/site/smt-gst.nsf/en/sf08739e.html>
- Policy released in June 2006 for the use of Television Channels 21 to 51

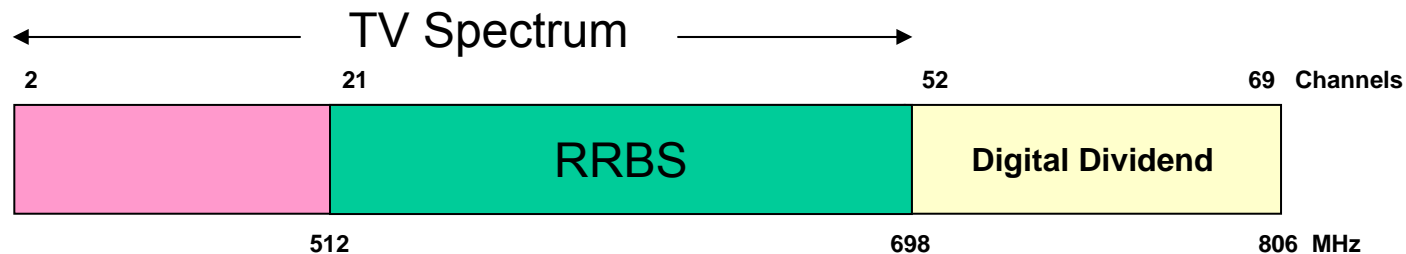

- **KEY FINDING:** There can be a number of vacant (*unassigned and non-allotted*) TV channels, **especially** in rural areas



## Key Elements of Service

- **Operation of new wireless services in TV bands is on a secondary basis with respect to TV**
- **Applications are for fixed (point to multipoint) systems only typically for areas lacking existing broadband (e.g. DSL & Cable) & for TDD and FDD operations**
- **Authorized at sufficient distance from major population centres on the condition that they do not constrain the provision of existing and new broadcasting services**
- **Higher Power Base Stations (up to 500W EIRP) - capable of nLOS delivery up to few 10's of km's**
- **TV services are horizontally polarised, RRBS is vertical – some protection is derived here**

*This is not cognitive radio white space use like FCC un-licensed device use  
Sites and services including spectrum are individually planned and coordinated  
around TV services*

## US & Canada...Key differences

- **U.S has proposed relatively **low-power license-exempt** operations**
  - Rely on dynamic interference avoidance
  - Fixed devices capable of rural and urban broadband wireless services.
  - Portable/Personal devices capable of providing in-home wireless networking similar to Wi-Fi
- **Canada has adopted a **high-power licensed** approach to service larger areas**
  - Frequencies are assigned by Industry Canada on a case-by-case basis
  - Fixed devices may provide broadband services in Rural areas. Potential range up to 30 km
  - The licensed approach has an advantage of receiving less opposition from incumbent broadcasters

The 2 models are not mutually exclusive and could co-exist, but there are currently no proposals to allow low-power licence-exempt whitespace devices in Canada

## Canada RRBS Status

- **Significant interest from Industry in obtaining licensed spectrum**
- **Received large number of applications from several WISPs**
  - (applications in the 100s)
  - Some looking to compliment their existing services in limited poorer performing licence-exempt bands (e.g. 900 MHz)
- **Many licenses issued already in parts of Canada**
- **A small number of developmental / experimental deployments**
  - Prototype equipment
  - Positive results
- **No commercial services deployed and operating as yet**

## Industry Challenges

- **Business challenges in delivering rural broadband service**
  - Customer base in low subscriber density areas
  - Sustainability of services offered over time
  - Equipment cost (scalability) for small deployment numbers
  
- **Technical Challenges**
  - Deployment in areas that lack existing infrastructure (eg. microwave or fibre backhaul)
  - No *off-the-shelf* equipment available
    - Industry looking to build front-end solutions to available (e.g. WiMAX & wireless DOCSIS) equipment
  - Challenges in finding/developing cost effective equipment to meet strict regulatory specifications required to protect television receivers operated by neighbours

# Regulator Challenges

- **Difficult sharing environment**
  - RRBS receives no interference protection from Broadcasting Services
    - Well devised planning & frequency selection is paramount to ensure sufficient QoS
    - Few commonly accepted planning parameters for this type of service in this band
  - Often limited available channels once broadcast allocations are considered
  - Challenges with sharing between FDD and TDD and unsynchronised TDD systems without a formal band plan
  
- **Protection of planned and future DTV Services**
  - There is historically no protection afforded to DTV receivers from alternate adjacent channel interference ( $N\pm 2$ ,  $N\pm 3$ , etc.)
    - Uncertainty about DTV receiver robustness against interference on alternate adjacent channels
      - What is the typical equipment performance?
    - What are the industry trends in DTV receiver design?
      - (Canada is not mandating receiver performance standards)
  
- **Regulator is working with industry to finalise equipment specifications**

# Summary

- Introduction
- FCC Report & Order
- Industry Canada
- **Ofcom**
- Netherlands Antilles

# Ofcom

## Overview of Available Spectrum

- **Analogue used 368MHz in UHF band (470-862MHz) – just under half of the best spectrum**
- **256MHz reserved for Digital Terrestrial TV (DTT)**
- **112MHz freed up by Digital Switch Over (DSO)**
  - plus 2 x 8MHz freed from aeronautical radar and radio astronomy
  - in total 128MHz of cleared spectrum
- **DSO occurring between 2007 and 2012 – region by region**
- **Also opportunities for white space in DTT network - “interleaved spectrum” (e.g. Local TV, PMSE, Cognitive)**

“PMSE” Programme Making and Special Events  
includes radio microphones

# A Brave New World

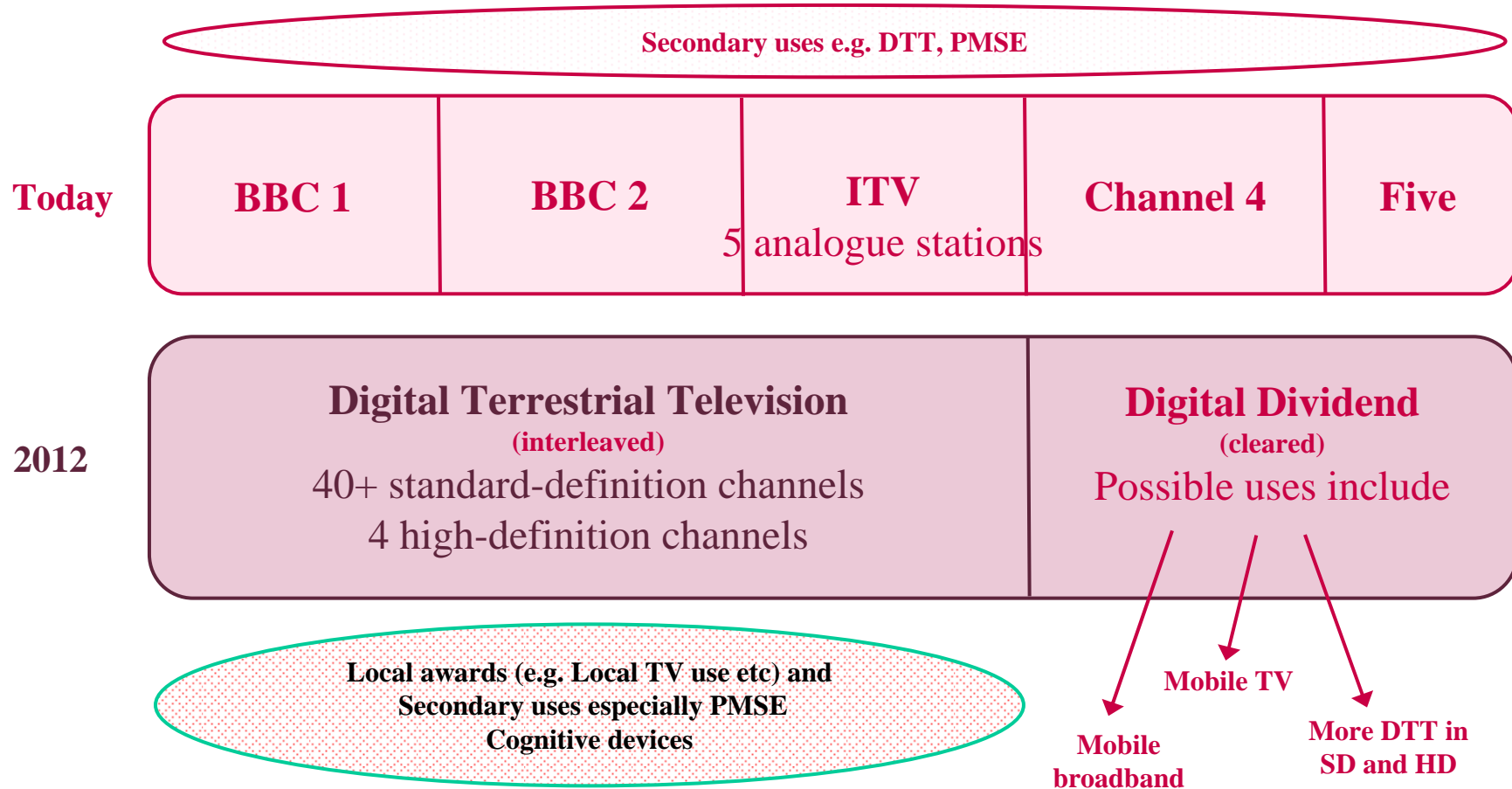



# Ofcom's February 2009 Proposals

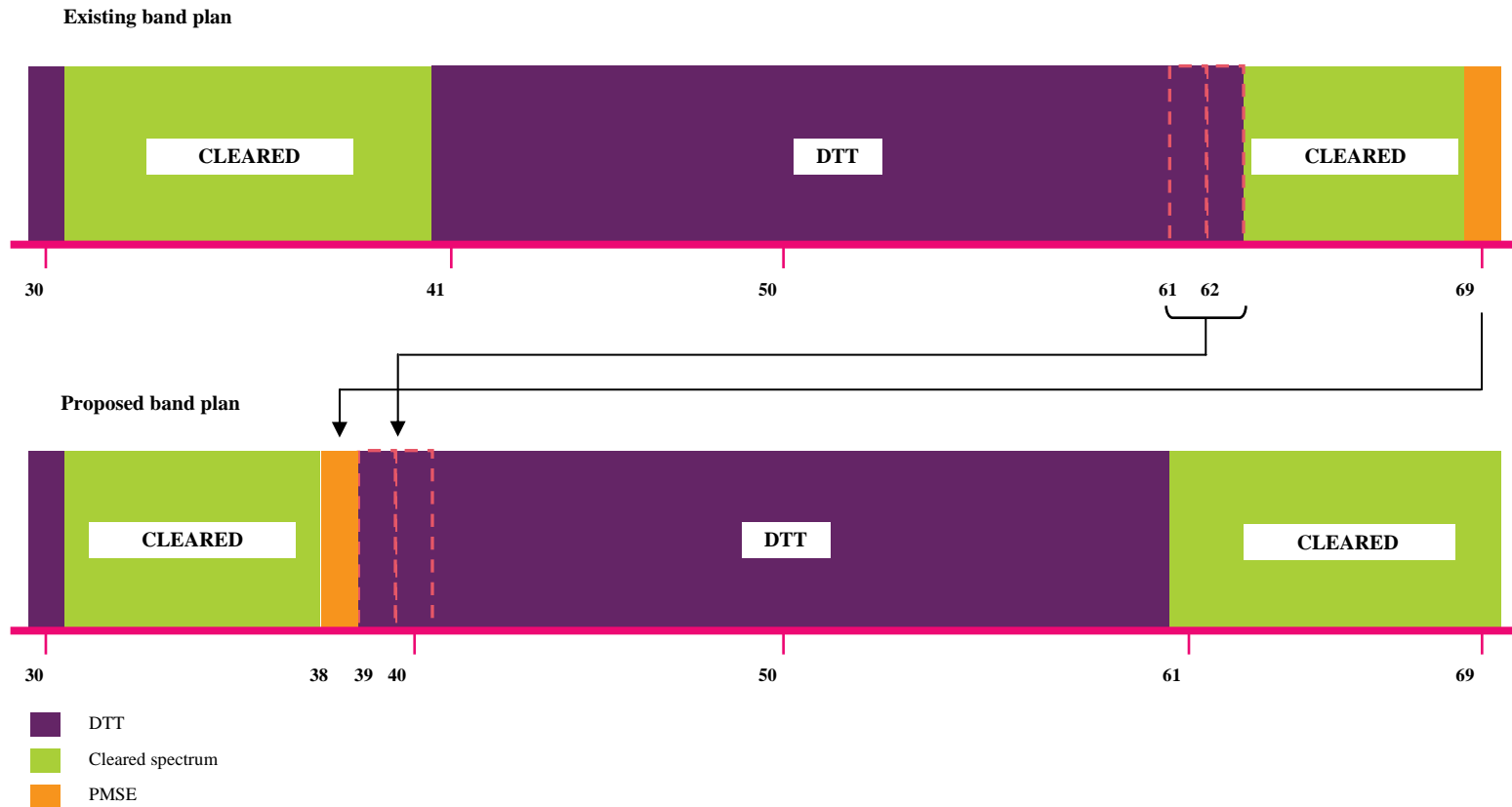

Due to European harmonisation proposals Ofcom had to re-evaluate plans (See Feb 09 consultation)

# Interleaved DTT spectrum after DSO

## 3 parallel approaches

### 1. Auctioning geographic packages suitable for local television

- One or two 8 MHz packages in 25+ locations
- Each package able to support a DTT multiplex carrying two to 10 video streams
- Combined award of packages with large coverage most suitable for aggregation
- Award by auction

### 2. Packaging the remaining interleaved spectrum with other spectrum allocated to PMSE

- Award via beauty contest to a band manager
- Required to meet reasonable PMSE demand on fair, reasonable and non-discriminatory terms until 2018, facilitating the transition to market-based access
- Can allow other users to access spectrum so long as PMSE obligations met
- Annual licence fee based on opportunity cost, recouped from customer charges

### 3. We have also proposed unlicensed cognitive access to interleaved spectrum

- Potential to support a wide range of uses, including high-speed always-on broadband
- Particularly suited to operating in interleaved spectrum
- Significant scope to benefit from international economies of scale
- Needs to protect licensed users (including DTT and PMSE) from harmful interference

# Interleaved spectrum available across the UK

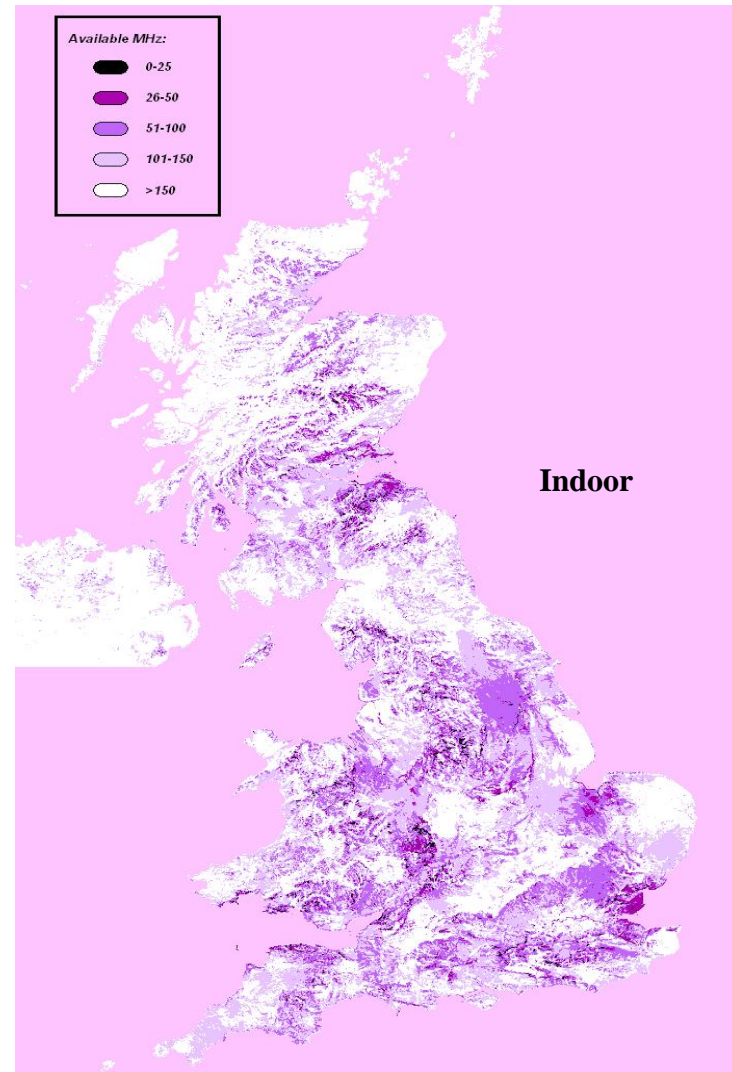
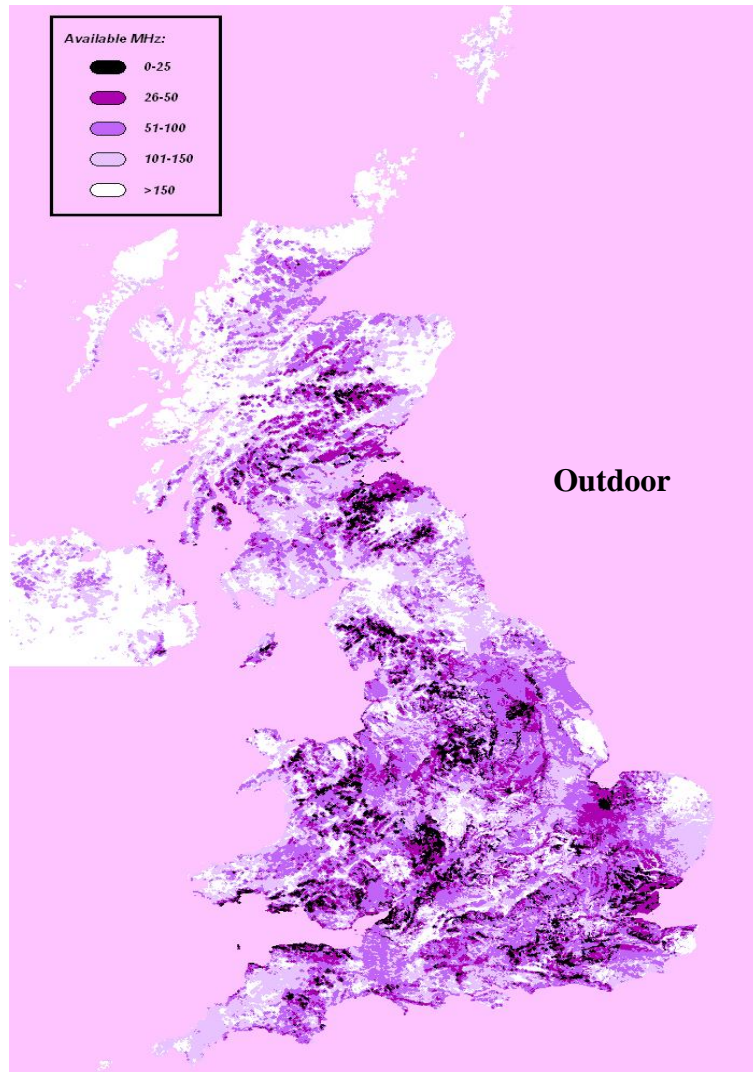

# Potentially over 100MHz available in the interleaved spectrum

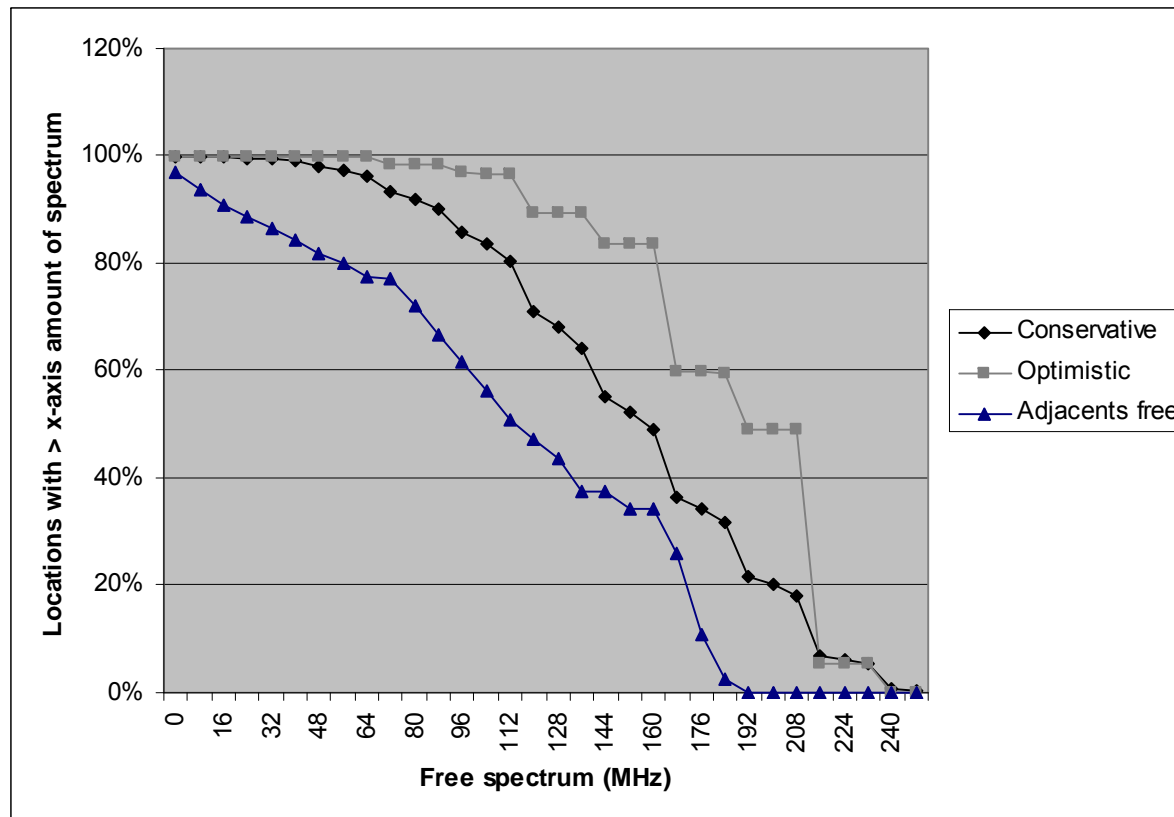

## Three approaches to cognitive access have been suggested

- **Sensing**
  - Can be introduced without additional infrastructure or standardisation
  - Can make effective use of the white space as long as false positives are avoided
  - But the hidden terminal problem results in some residual probability of interference
- **Geolocation**
  - Requires a database, devices to self-locate and licence holders to update database
  - Makes effective use of the white space
  - If correctly set up there will be no interference
- **Beacons**
  - Requires an infrastructure to transmit as well as a database to store the information to be transmitted
  - Makes less effective use of the white space because the beacon has to be restricted to less than the white space area to avoid “spill-over”
  - Interference might still occur
  - Not the preferred option and so not considered further
- **Consultation closes May 1<sup>st</sup>** <http://www.ofcom.org.uk/consult/condocs/cognitive/>

## Key parameters proposed for sensing

Cognitive Parameter	Value
Sensitivity assuming a 0 dBi antenna	-114 dBm in 8 MHz channel (DTT) <b>-126 dBm<sup>1</sup></b> in 200 kHz channel (wireless microphones)
Transmit power	<b>13 dBm<sup>2</sup></b> (adjacent channels) to 20 dBm
Transmit-power control	Required
Bandwidth	Unlimited
Out-of-band performance	<b>&lt; -44 dBm<sup>3</sup></b>
Time between sensing	<b>&lt; 1 second<sup>4</sup></b>
Maximum continuous transmission	400 milliseconds
Minimum pause after transmission	100 milliseconds

We have derived these parameters from a mix of theory and measurement. Where a range of acceptable parameters includes those adopted elsewhere in the world, we have proposed the values from the latter in the interest of promoting international economies of scale.

**Note: The above parameters are for SENSING ONLY systems**

- FCC R&O:
- <sup>1</sup> -114dBm
  - <sup>2</sup> 16dBm (40mW)
  - <sup>3</sup> 55dBc
  - <sup>4</sup> 1 minute

## Key parameters proposed for geolocation

Cognitive Parameter	Value
Locational accuracy	100 <sup>1</sup> metres
Frequency of database access	(to be determined)
Transmit power	As specified by the database
Transmit-power control	Required
Bandwidth	Unlimited
Out-of-band performance	< -44 dBm
Maximum continuous transmission	400 milliseconds
Minimum pause after transmission	100 milliseconds

We have derived these parameters from a mix of theory and measurement. Where a range of acceptable parameters includes those adopted elsewhere in the world, we have proposed the values from the latter in the interest of promoting international economies of scale.

FCC R&O: <sup>1</sup> 50 meters

## Summary

- Introduction
- FCC Report & Order
- Industry Canada
- Ofcom
- **Netherlands Antilles**



# Background of the Netherlands Antilles



- The Netherlands Antilles is member of the Kingdom of the Netherlands and is administered by a democratically elected local government
- Dutch Antilles consist of 2 leeward islands:
  - Curacao: the capital and the main seat of government
  - Bonaire
 and 3 windward islands:
  - Saba
  - St. Eustatius
  - St. Martin: the northern part falls under the administration of France and therefore Operators consult in general with the French Spectrum Management Authority as well
- UHF TV channels are based on European standards (ETSI) - 8MHz wide

- TV Band spectrum:
  - VHF Band I (channel 1-4 / 41-68 MHz)
  - VHF Band III (channel 5-12 / 174-230 MHz)
  - UHF Band IV/V (channel 21-69 / 470-862MHz)
- There are currently 3 ATV channels broadcasting inside the Netherlands Antilles. Since there haven't been any DTV channels allocated (although requests were made) the TVWS DTV database would currently be “full of nothing” !
- As in other parts of the Caribbean there is a huge digital divide. Only a tiny fraction (less than 5%) of households have broadband access

## Background of the DoI

- **Potential for:**
  - More efficient usage of the country's spectrum
  - Decrease prices of broadband by levelling the playing field
- **With introduction of flexible regulations the Netherlands Antilles has the potential to become a frontrunner in the area of TVWS**
- **Create an attractive environment for global technology companies to roll out and and test their latest specifications in the Netherlands Antilles**
- **Fulfil the targets set in the “Connect the Caribbean” initiative, setting a benchmark for the region**
- **On the request of the Minister of Transport, Minister Adriaens, the Spectrum Management Authority of the Netherlands Antilles passed a Declaration of Intention on Tuesday January 20<sup>th</sup> 2008**
- **The “Declaration of Intention” (DoI) is almost on the level of a Notice of the proposed rulemaking (NPRM) format being used in the US and is intended for review by the wireless industry. The document can be further adapted to the wishes of industry before issuance of the NPRM**
- **The Declaration of Intention is published on the website of the Spectrum Management Authority ([www.btnp.org](http://www.btnp.org)) under “news”**

# Spectrum Allocation

## Initial License:

- License acquisition requires island-wide network roll-out by operator
- A number of RF channels will be allocated to the operator based on their demands. These channels will be used for exclusive access (i.e. “clean spectrum”) to the operator for a limited time.
- This allows to start as a non-coexistent network. To maintain the license an operator will have to meet certain targets of coexistence with other TVWS networks over time. The targets will be set in consultation with the Spectrum Management Authority of the Netherlands Antilles

## After the expiration of the Initial License:

- Spectrum will allocated by a regionally, temporary and consumer driven real-time “auctioning system” operated by the Spectrum Management Authority of the Netherlands Antilles.
- Again an operator will only be able to participate in this system if he is able to coexist with other TVWS networks within the same channel.

## Unlicensed networks:

- In this scenario all unlicensed devices (including microphones) have a lower priority than licensed devices. This shouldn't be too much of a problem at the moment with the vast amount of spectrum available (approx. 368MHz). In case unlicensed TVWS devices becomes problematic over time, the Spectrum Management Authority will allocate a limited number of UHF TV channels for the exclusive use of unlicensed devices.

## **In accordance with the FCC R&O**

- **Allowance of unlicensed devices under the same conditions (eg. transmit power) as approved in the FCC Report & Order 08-260**

## **Differences with the FCC R&O**

### **Initial phase:**

- **Transmit power EIRP for portable and fixed licensed devices must remain within established radio frequency safety limits**

### **Auctioning phase:**

- **Allocate spectrum to operators on a geographical basis. Transmit power has to stay within RF safety limits**
- **Give every operator participating an equal amount of first priority spectrum, which gives the first right of usage**
- **Give every operator a secondary priority right to use other operators empty/unused spectrum, without causing interference to those operations**
- **Spectrum rights can be divided in time slots (minutes, hours, days, weeks, months), and a certain amount of bandwidth to its users**
- **Users are also able to switch between the networks of operators**
- **Applying a percentage taxation on every transaction done, which gives room for incentives**

## **EC SG Recommendation**

- **The ECSG will not provide input to 802.18 for the Petition of Reconsideration of the FCC R&O, understanding that the normal mechanisms in place are already addressing feedback required on this topic via 802.18 and the WGs**

**Other Recommendations to be developed through the week**

## References

- FCC Proceeding 04-186 [http://fjallfoss.fcc.gov//prod/ecfs/comsrch\\_v2.cgi](http://fjallfoss.fcc.gov//prod/ecfs/comsrch_v2.cgi)
- FCC Report & Order 08-260 [http://hraunfoss.fcc.gov/edocs\\_public/attachmatch/FCC-08-260A1.pdf](http://hraunfoss.fcc.gov/edocs_public/attachmatch/FCC-08-260A1.pdf)  
FCC Erratum January 9, 2009 DA 09-20  
[http://www.fcc.gov/Daily\\_Releases/Daily\\_Business/2009/db0109/DOC-287799A1.pdf](http://www.fcc.gov/Daily_Releases/Daily_Business/2009/db0109/DOC-287799A1.pdf)
- IEEE Std 802.11-2007 and amendments 1, 2 and 3 <http://standards.ieee.org/getieee802/802.11.html>  
IEEE 802.11 TV white space documents  
<https://mentor.ieee.org/802.11/file/08/11-08-1254-03-0wng-tv-white-space-fcc-action.ppt>  
<https://mentor.ieee.org/802.11/file/08/11-08-1439-01-0wng-fcc-08-260-clauses-devices-and-pops.xls>
- IEEE 802.22 documents <https://mentor.ieee.org/802.22/documents>
- Wireless Innovation Alliance <http://www.wirelessinnovationalliance.org>
- New America Foundation <http://www.newamerica.net/>
- TV signal locators  
[http://www.tvfool.com/index.php?option=com\\_wrapper&Itemid=29](http://www.tvfool.com/index.php?option=com_wrapper&Itemid=29)  
<http://www.showmywhitespace.com/>  
<http://www.fcc.gov/mb/engineering/maps>
- FCC's Stimulus Funding page <http://www.fcc.gov/recovery/>
- USDA/RUS program <http://www.usda.com/rurdev>
- NTIA Grant program <http://www.ntia.doc.gov/broadbandgrants>
- US OMB Guidance for US Government Agencies  
<http://www.internet2.edu/government/docs/InitialRecoveryActImplementingGuidance.pdf/>
- Ofcom consultations  
<http://www.ofcom.org.uk/consult/condocs/cognitive/>  
<http://www.ofcom.org.uk/consult/condocs/800mhz/>

# EXTRAS

## **Applications Envisaged**

- **Rural Broadband Deployment**
- **Auxiliary Public Safety Communications**
- **Educational and Enterprise Video Conferencing**
- **Personal Consumer Applications**
- **Mesh Networks**
- **Security Applications**
- **Municipal Broadband Access (Muni 2.0)**
- **Enhanced Local Coverage and Communications**
- **Fixed backhaul**
- **Sensor aggregation / backhaul - eg. for smart grid meter reading**

**Very wide range!**  
**Refer to Use Case section**



## **TVWS - What's the Attraction?**

- **75% vacant in some parts of the country (according to WIA)**
- **“Beachfront” spectrum – much better propagation than 2.4 or 5GHz**
- **Estimated value if licensed \$8-24B**
- **But . . .**
- **Amount free is different in every location and can change daily!**
- **According to FCC . . .**
  - new and innovative products and services including broadband data and other services for business and consumers
  - expect to benefit WISPs by extending service reach to new customers and improve service in rural areas

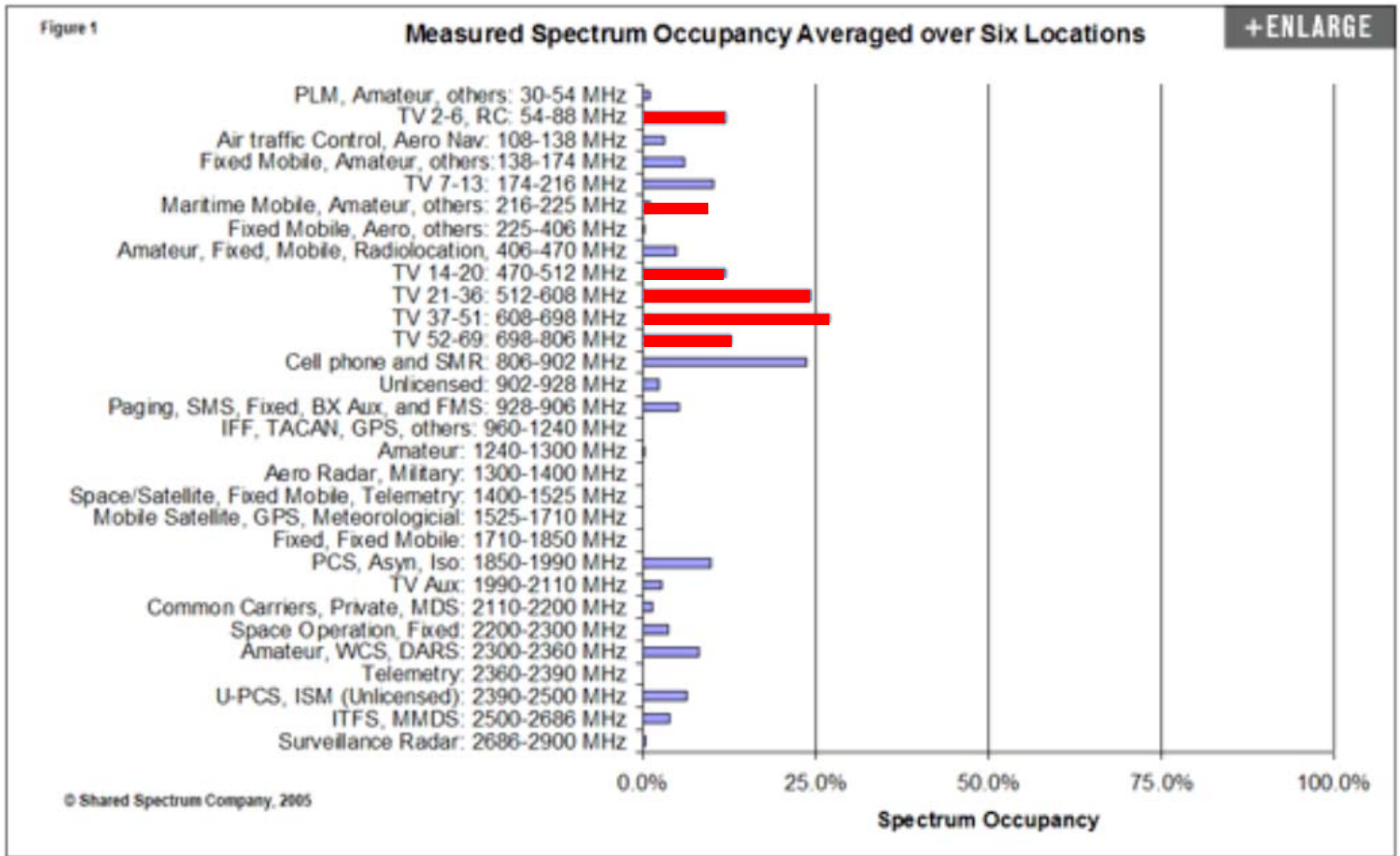

# Spectrum Usage

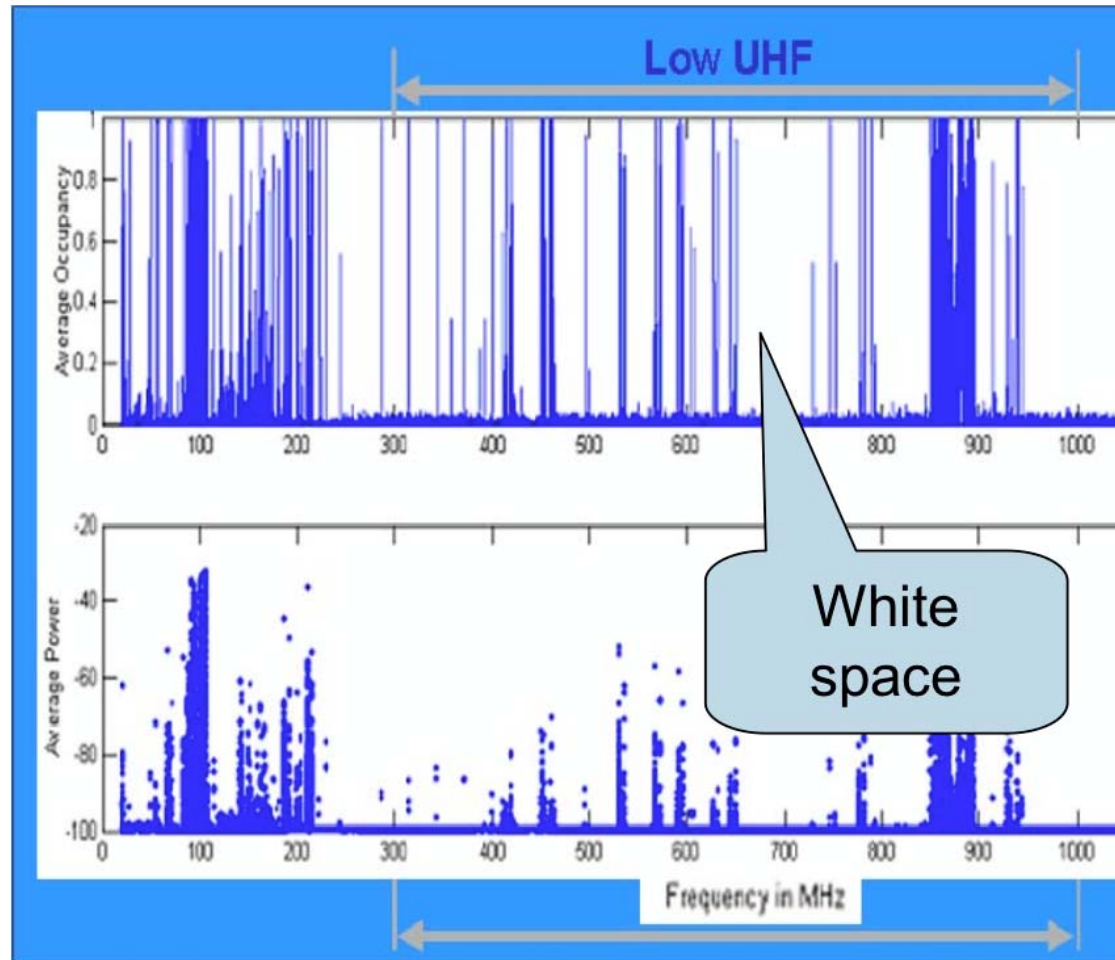

Rural location west of Ottawa Canada

# Channel 5 in the Eastern US

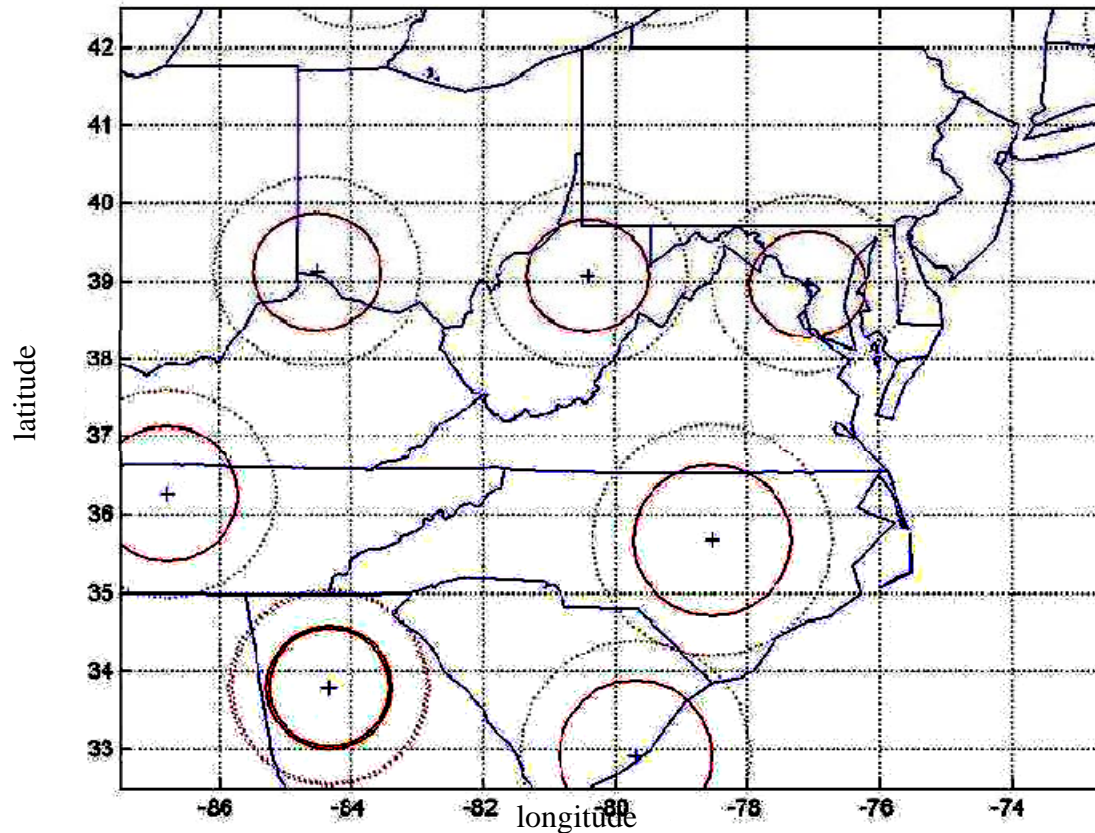

A Grade B contour is the geographic area in which it is predicted that a consumer with an outdoor rooftop receiving antenna can pick up a signal of Grade B intensity from the local network broadcast station

$F(90,50) =$   
90% of time, 50% of locations

41db $\mu$ V/m for ATSC UHF  
64db $\mu$ V/m for NTSC UHF

Grade B 50% and 90% contours

# Channel 54 in the Eastern US

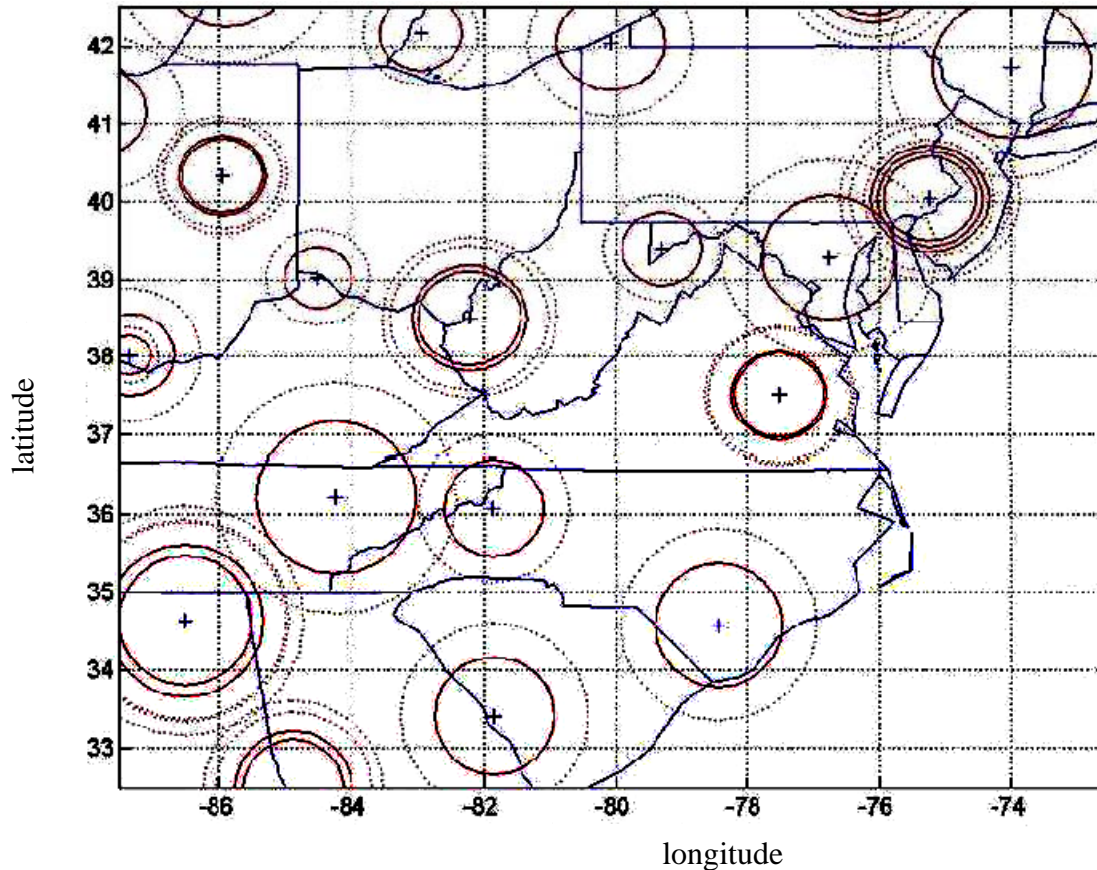

Grade B 50% and 90% contours

A Grade B contour is the geographic area in which it is predicted that a consumer with an outdoor rooftop receiving antenna can pick up a signal of Grade B intensity from the local network broadcast station

$F(90,50) =$   
90% of time  
50% of locations  
41db $\mu$ V/m for ATSC UHF  
64db $\mu$ V/m for NTSC UHF



Transition Channels 14 – 59

 All Blocked

 10+ Free

March 2009

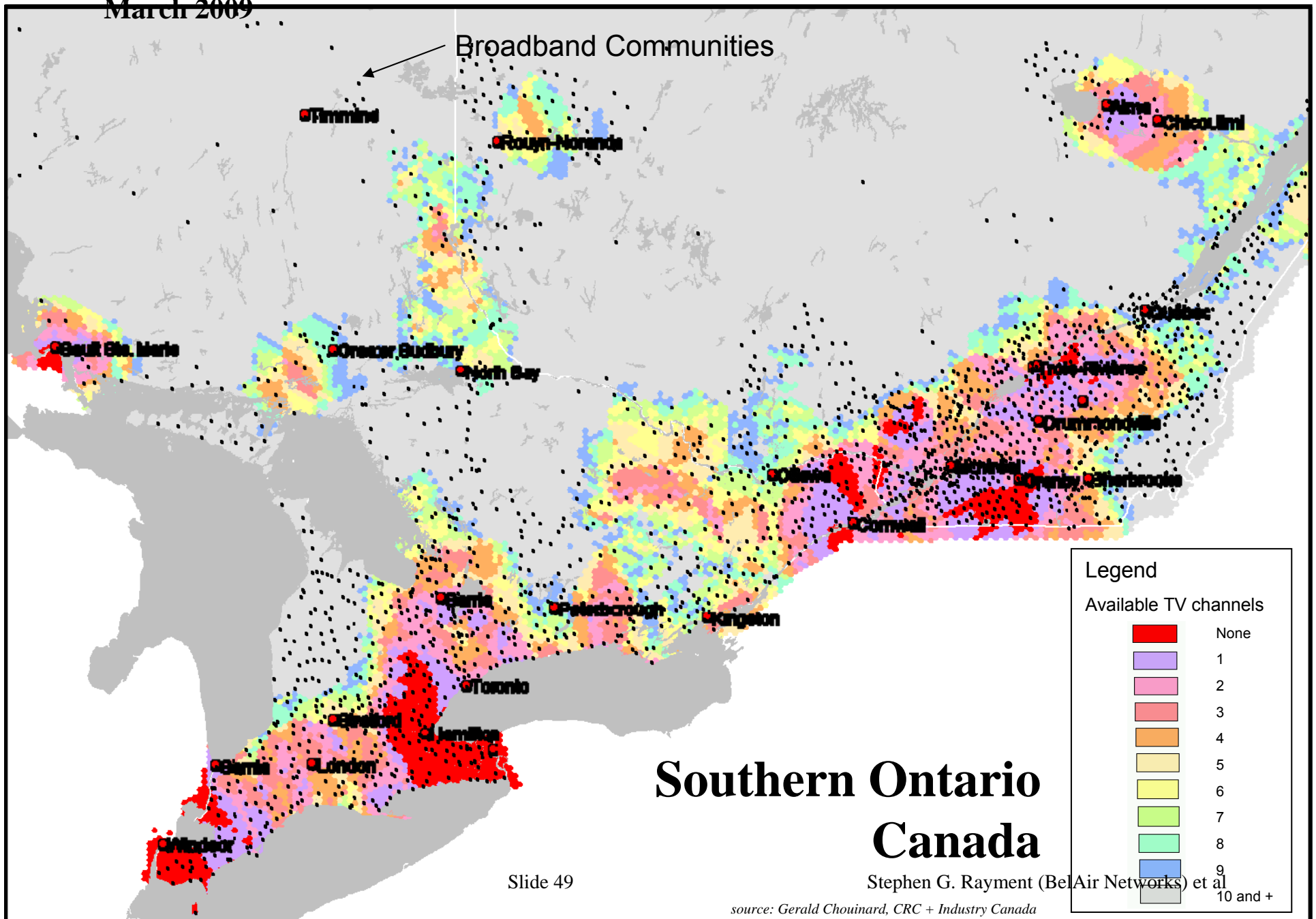

# Southern Ontario Canada

Slide 49

Stephen G. Rayment (Bell Air Networks) et al

source: Gerald Chouinard, CRC + Industry Canada

# Cognitive Radio

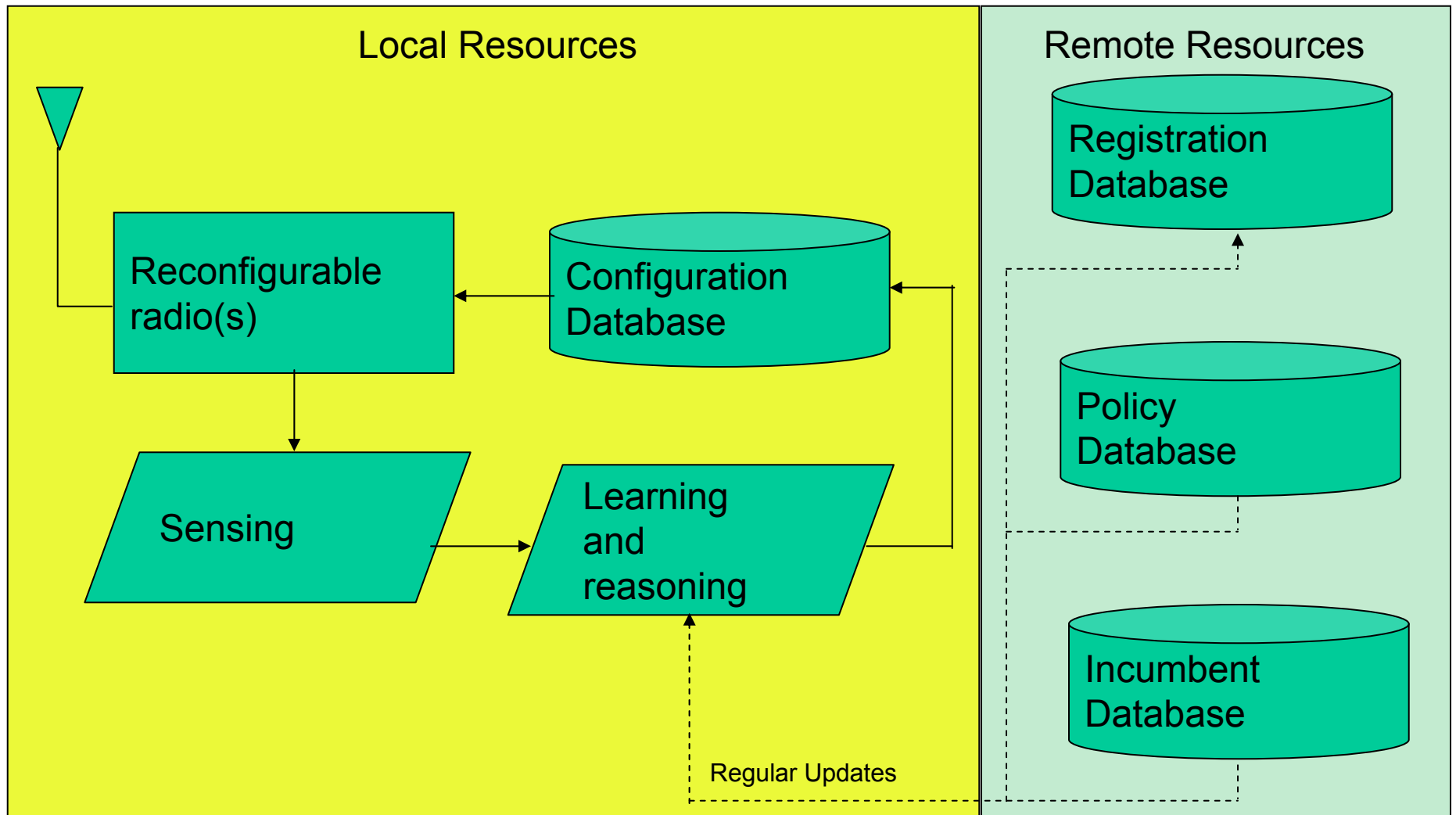

# Remember . . .

## Part 15 Rules Provide Few Rights

- **15.5(a) Persons operating radiators have no right to continued use of any frequency by virtue of prior registration or certification of equipment**
- **15.5(b) No harmful interference is caused, and interference must be accepted that may be caused by the operation of an authorized radio station**
- **15.5(c) The operator of a radio frequency device shall be required to cease operating the device upon notification by a Commission representative that the device is causing harmful interference**

*----> just like Wi-Fi!!*

### And TV gets priority . . .

- **The FCC has protected all existing licensed uses:**
  - (A) Digital TV stations,
  - (B) Digital and analog Class A TV stations,
  - (C) Low power TV stations,
  - (D) TV translator and booster stations,
  - (E) Broadcast Auxiliary Service stations,
  - (F) Cable TV headends,
  - (G) TV translator station receive sites,
  - (H) Sites where low power auxiliary, including wireless microphones and wireless assist video devices are used, and their schedules for operation
- **The FCC has protected some TV band Private Land Mobile Radio Services/Commercial Mobile Radio Services in 13 metro areas**
- **TV white space at a location is the unused TV channels at that location at that time (wireless microphones come and go)**
- **Licensed uses continue to be protected to their full extent of operation**



## Current Digital Dividend Consultations

**There are two relevant Digital Dividend consultations out at the moment:**

**Digital Dividend : Clearing the 800 MHz Band      closing date 20/04/09**

<http://www.ofcom.org.uk/consult/condocs/800mhz/>

**Digital Dividend : Cognitive Access      closing date 01/05/09**

<http://www.ofcom.org.uk/consult/condocs/cognitive/>

**Ofcom would welcome input either as individual companies or as IEEE 802 or both!**

## **It may take years to fully complete the process**

- **This consultation closes at the end of April**
- **Depending on the responses, further consultation may be needed, particularly on geolocation**
- **In parallel work at a European level to develop a harmonised approach – timescales unclear**
- **In due course issue a Statement and Statutory Instrument (exempting cognitive devices from licensing) as appropriate**
- **This timing is appropriate because**
  - Caution is needed before allowing devices that might interfere
  - The industry is still some way from producing consumer devices

Project	<b>IEEE 802 Executive Committee Study Group on TV White Spaces – ADHOC USE CASE SUB-GROUP</b>
Title	<b>ECSG ADHOC USE CASE Tutorial</b>
Date Submitted	
Source(s)	Contributor: Mark Cummings, Affiliation enVia Voice: +1 650 854 4406, e-mail: <a href="mailto:markcummings@envia.com">markcummings@envia.com</a> Contributor: Nanci Vogtli, Affiliation Concrete Logic Voice: (408) 354-8070, e-mail: <a href="mailto:nancivogtli@concrete-logic.com">nancivogtli@concrete-logic.com</a> Contributor: Richard Paine, Affiliation Self Voice: 206-854-8199, e-mail: <a href="mailto:richard.h.paine@gmail.com">richard.h.paine@gmail.com</a> Contributor: Dan Lubar, Affiliation RelayServices Voice: (877) 569-5069, e-mail: <a href="mailto:dlubar@relayservices.com">dlubar@relayservices.com</a> Contributor: Scott Blue, Affiliation: Sensable Radio, email: <a href="mailto:blue@sensableradio.com">blue@sensableradio.com</a> Contributor: Gerald Chouinard, Affiliation CRC, email: <a href="mailto:gerald.chouinard@crc.ca">gerald.chouinard@crc.ca</a> Contributor: Jack Unger, Affiliation WISPA, email: <a href="mailto:junger@ask-wi.com">junger@ask-wi.com</a>
Abstract	TV White Space USE CASE Overview for the White Space Tutorial
Purpose	To help the 802 Community understand the opportunity and organize to capture its full potential
Release	The contributor grants a free, irrevocable license to the IEEE to incorporate material contained in this contribution, and any modifications thereof, in the creation of an IEEE Standards publication; to copyright in the IEEE's name any IEEE Standards publication even though it may include portions of this contribution; and at the IEEE's sole discretion to permit others to reproduce in whole or in part the resulting IEEE Standards publication. The contributor also acknowledges and accepts that this contribution may be made public by IEEE 802.
Patent Policy and Procedures	The contributor is familiar with the IEEE-SA Patent Policy and Procedures: <a href="http://standards.ieee.org/guides/bylaws/sect6-7.html#6">http://standards.ieee.org/guides/bylaws/sect6-7.html#6</a> and <a href="http://standards.ieee.org/guides/opman/sect6.html#6.3">http://standards.ieee.org/guides/opman/sect6.html#6.3</a> . Further information is located at <a href="http://standards.ieee.org/board/pat/pat-material.html">http://standards.ieee.org/board/pat/pat-material.html</a> and <a href="http://standards.ieee.org/board/pat">http://standards.ieee.org/board/pat</a> .

# Opportunity

- Every person and device on the planet to communicate using 802 standards
- Insufficient spectrum exists to accommodate all possible use cases
  - Creative refarming of spectrum allocated for other purposes
  - exploit "unused" spectrum, ie White Space and the 3650-3700MHz band
- Regulators are offering a trade off;
  - More Spectrum
  - More Complex Management
- TV White Space and 3650 are likely just the beginning
- General approach to the extended MAC
  - Radios have to identify "available" spectrum"
  - Availability is a function of both primary use and other potential White Space users
  - The specific species of 802 devices must coordinate between themselves to interoperate in accordance with regulatory policies and avoid interference with the Primary Users
  - Radios may want to coordinate between themselves in response to environmental (in the largest sense) changes.
    - **Beyond control (sun spots, multipathing, etc.)**
    - **Potentially controllable (other 802 species & non 802 radios)**

# Generalized Whitespace Use Cases

- Generalized Use Cases
  - 4W generally for rural/suburban
    - 4W to 100mW for Long Range Rural/Suburban With Extension
    - Asymmetric (4W Downlink & 100mW Uplink)
  - Congested Suburban / Urban (100mW)
  - Congested Urban (Sensing Only)
  - Short Range
- Use Case group used FCC power levels for use case descriptions

# 4W Fixed

- Outdoor use outside the TV protected contour (41dB $\mu$ V/m) and beyond the keep-out distance of all TV channels used in the area and their adjacent channels

star/tree/mesh

Geo-location  
Database of  
Incumbent Stations

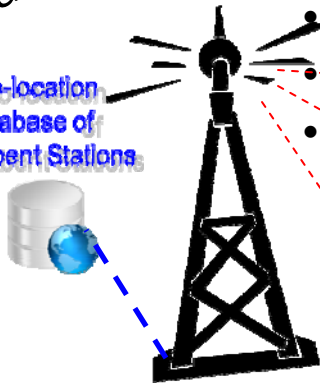

- Towns, villages
- Rural areas, Farms
- Suburbs



## Fixed Devices

- Grain Elevator Enterprise
- Slaughterhouse Enterprise
- Waterpark Enterprise
- Hunting Lodge
- Fishing Lodge
- Agriculture Enterprise
- Military Equipment
- Public Safety Equipment
- All Business Enterprises

## Fixed Registered Master

- Database Access
- Cell Towers Installable
- Private Comm. Systems
- Emergency Services
- Water Towers
- 20-30km Coverage
- Suburban
- Consolidated Access (MDU/MTU)
- Military Operations
- Public Safety



## Fixed Devices

- Light Residential/Suburban
- Farming & Agricultural

## Fixed Devices

- Ranching
- Mountainous

1/20/2009  
4

# 4W to 4W fed by 100mW

- Indoor or outdoor use outside of both the protected contour (41dB $\mu$ V/m) and also the keep-out distance of all channels or adjacent channels in use in the area of operation

- Towns, villages
- Rural areas, Farms
- Suburbs

star/tree/mesh

Geo-location Database of Incumbent Stations

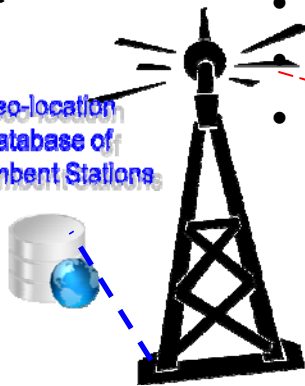

4W Fixed Master

- Database Access
- Cell Towers Installable
- Private Comm. Systems
- Emergency Services
- Water Towers
- 20-30km Coverage
- Suburban
- Consolidated Access (MDU/MTU)
- Military Operations
- Public Safety
- Private Radio Station

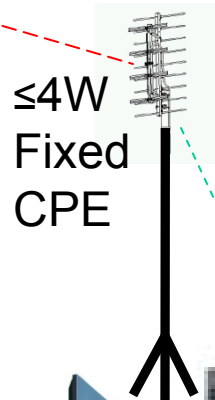

$\leq 4W$   
Fixed  
CPE

Access point  
(Portable TVBD or  
Wi-Fi)



100mW Personal/  
Portable Devices

- Movable Systems
- Internet Access
- Onboard Tractors
- VOIP
- Broadcast Radio

100mW Personal/Portable  
Devices

- Onboard
- Roaming computing devices
- Internet Access
- VOIP



100mW Personal/Portable  
Devices

- Mobile
- Push to Talk
- Internet Access
- VOIP

# 4W to portable 100mW

- Indoor or outdoor use outside of both the protected contour (41dBµV/m) and also the keep-out distance of all channels or adjacent channels in use in the area of operation

star/tree/mesh

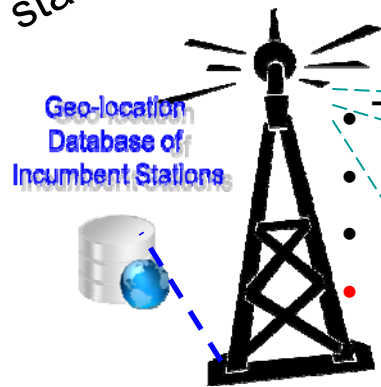

- Towns, villages
- Rural areas, Farms
- Suburbs
- **Urban/Metropolitan – only where spectrum is available**

Download bandwidth > Upload bandwidth

## 4W Fixed Master

- Database Access
- Cell Towers Installable
- Private Comm. Systems
- Emergency Services
- Water Towers
- 20-30km Coverage
- Suburban
- Consolidated Access (MDU/MTU)
- Military Operations
- Public Safety
- Private Radio Station



## 100mW Personal/Portable Devices

- Movable Systems
- Internet Access
- Onboard Tractors
- VOIP
- Broadcast Radio

## 100mW Personal/Portable Devices



- Onboard
- Roaming computing devices
- Internet Access
- VOIP



## 100mW Personal/Portable Devices

- Mobile
- Push to Talk
- Internet Access
- VOIP

-----  
Personal/Portable Devices are directly connected at 100mW near the Fixed Master



# 100mW

- Indoor or outdoor use outside of both the protected contour (41dB $\mu$ V/m) and also the keep-out distance of all channels or adjacent channels in use in the area of operation

## Suburban Neighborhoods

- Farm
- Wireless device access in a residence or farm or neighborhood
- Areas of weak TV broadcast signals
- Access Points – may or may not be for broadband Internet access
- Unlicensed Voice Applications – ex: Femtocell-like
- Point-to-Point Wireless
- Physical Area
- LAN 100m
- Residential
- Neighborhood or farm

star/tree/mesh

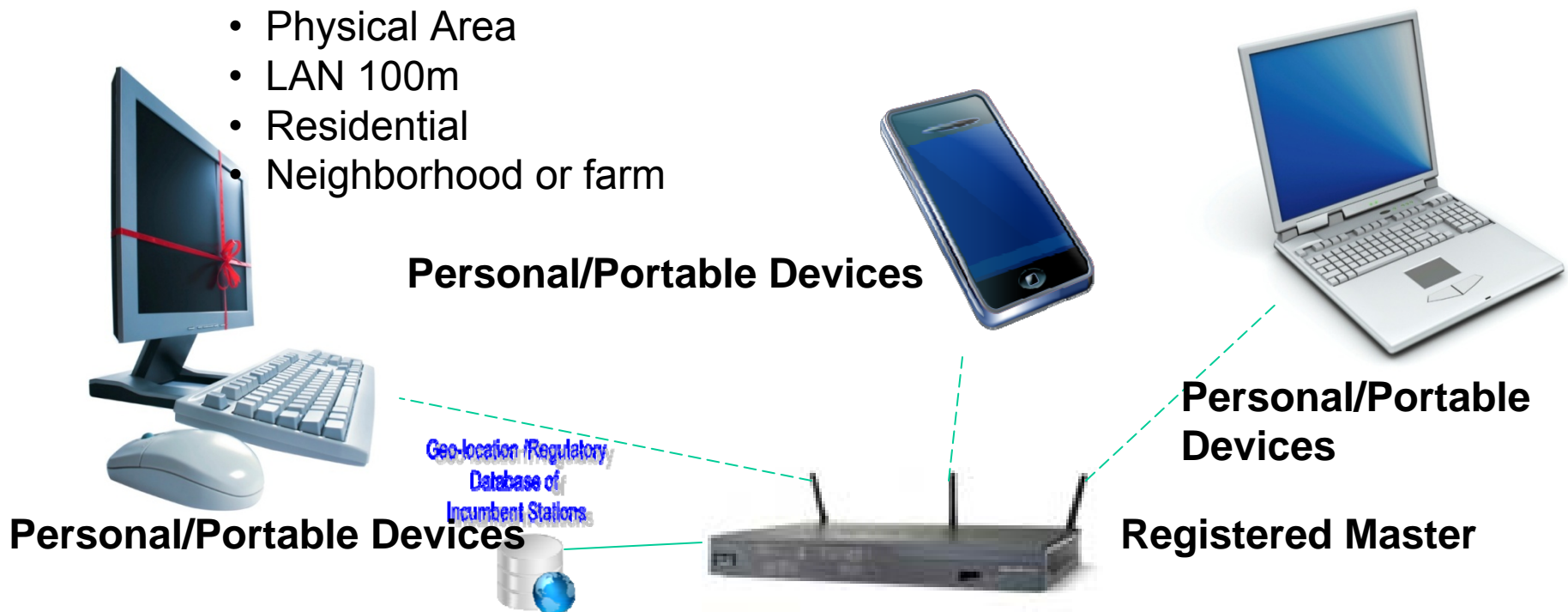

# 50mW (Sensing Only)

- Indoor or outdoor use outside of both the protected contour (41dB $\mu$ V/m) and also the keep-out distance of all channels or adjacent channels in use in the area of operation
- Access Points
- Unlicensed Voice Applications – ex: Femtocell-like
- Point-to-Point Wireless (ie Peer to peer/DLS)
- Portability
- Body Area Networks (BAN) – may not be broadband Internet access
- Area
- Indoor Networks
- PAN
- 10m

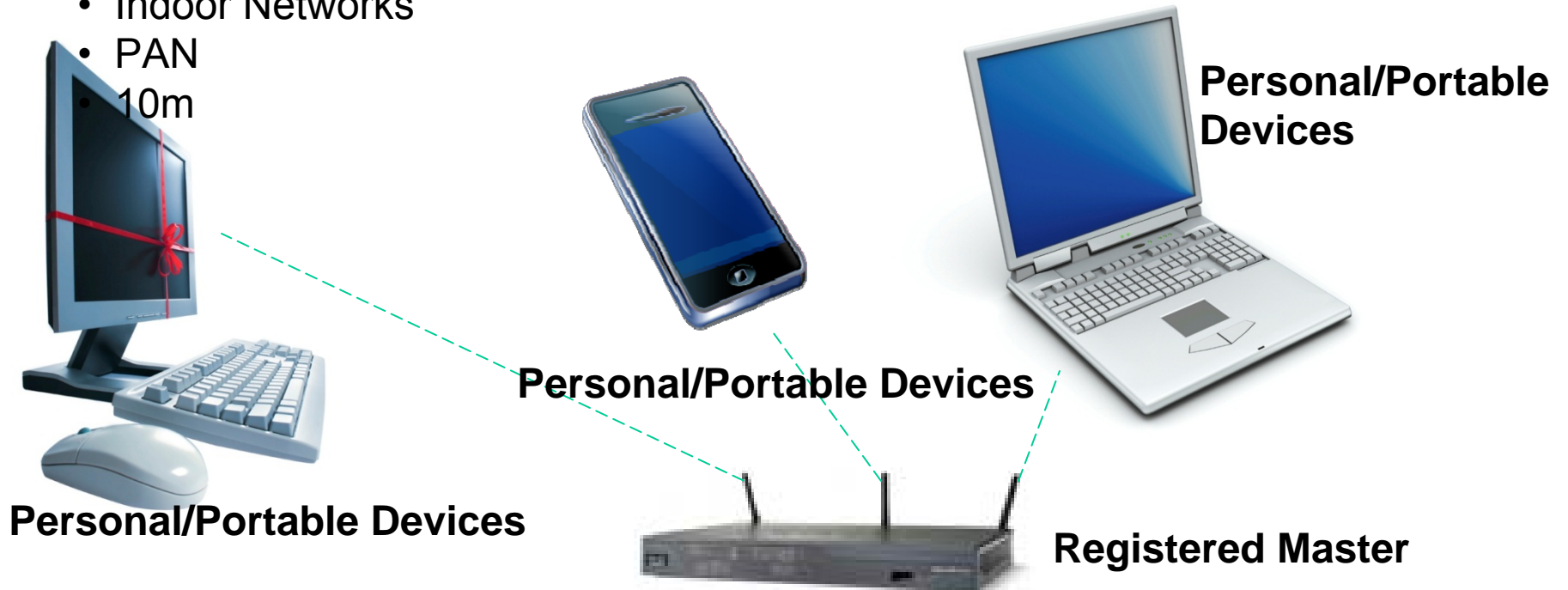

# $\leq 40\text{mW}$

- In-building outside the protected contour (41dB $\mu$ V/m) and beyond the keep-out distance of all channels being used in the area
- Body Area Networks (BAN) – may not be broadband Internet access
- Protection Beacons and Microphones
- In-home backhaul
- Network Sensors/Control Devices
- Smart Utility Networks
- PANs

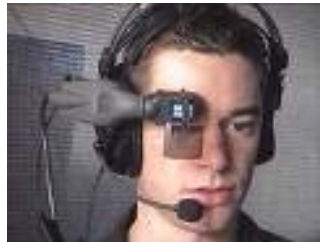

**Personal/Portable Devices Personal/Portable Devices Personal/Portable Devices**

# Use Case ADHOC Conclusions..

- FCC's TVWS Rules will see "fixes"..
  - Current rules do not completely address all potential problems..
  - TVWS proceeding is on going thanks to a number reconsideration filings..
  - Many Non-US Regulatory bodies watching US TVWS proceeding intently
- Use of any White Space spectrum will be part of a larger Wireless ecosystem
  - And will be driven by Market demands, Policy requirements, & Service Rules
- The most common "use cases scenarios" will likely be hard to predict..
  - Initial "uses cases" will be driven by existing market forces
  - US "legacy regulatory environment" means "innovative uses" may lag
- TVWS & 3650 are just the beginning of opportunistic spectrum use
  - Other approaches being considered in other bands, both here & abroad
- Other non-802 SDO's are likely to define Standards to use White Space
- For white space use, 802 might consider..
  - Fostering cooperation/liaison's between 802 Standards & Non-802 Standards
  - A "more direct, formal, & timely" liaison process with other SDO's

# Coexistence Tutorial Material

Date: 2009-03-10

**Authors:**

Name	Company	Address	Phone	E-mail
Steve Shellhammer	Qualcomm	5775 Morehouse Dr San Diego, CA 92121	(858) 658-1874	Shellhammer@ieee.org
Juan Carlos Zúñiga	InterDigital	1000 Sherbrooke W 10 <sup>th</sup> Floor Montreal, QC, Canada	+15149046251	j.c.zuniga@ieee.org
Mariana Goldhamer	Alvarion	Tel Aviv, HaBarzel St., 21A, Israel	+97236456241	mariana.goldhamer@alvarion.com
Wendong Hu	STMicroelectronics	1060 East Brokaw Road, San Jose, CA 95131, USA	(408) 467-8410	wendong.hu@st.com

**Notice:** This document has been prepared to assist IEEE ECSG on TV White Space. It is offered as a basis for discussion and is not binding on the contributing individual(s) or organization(s). The material in this document is subject to change in form and content after further study. The contributor(s) reserve(s) the right to add, amend or withdraw material contained herein.

**Release:** The contributor grants a free, irrevocable license to the IEEE to incorporate material contained in this contribution, and any modifications thereof, in the creation of an IEEE Standards publication; to copyright in the IEEE's name any IEEE Standards publication even though it may include portions of this contribution; and at the IEEE's sole discretion to permit others to reproduce in whole or in part the resulting IEEE Standards publication. The contributor also acknowledges and accepts that this contribution may be made public by IEEE 802.

**Patent Policy and Procedures:** The contributor is familiar with the IEEE 802 Patent Policy and Procedures <[http:// ieee802.org/guides/bylaws/sb-bylaws.pdf](http://ieee802.org/guides/bylaws/sb-bylaws.pdf)>, including the statement "IEEE standards may include the known use of patent(s), including patent applications, provided the IEEE receives assurance from the patent holder or applicant with respect to patents essential for compliance with both mandatory and optional portions of the standard." Early disclosure to the TAG of patent information that might be relevant to the standard is essential to reduce the possibility for delays in the development process and increase the likelihood that the draft publication will be approved for publication. Please notify the Chair <matthew.sherman@baesystems.com> as early as possible, in written or electronic form, if patented technology (or technology under patent application) might be incorporated into a draft standard being developed within the IEEE. **If you have questions, contact the IEEE Patent Committee Administrator at <[patcom@ieee.org](mailto:patcom@ieee.org)>.**

## Abstract

- **This presentation contains the Coexistence material for the TV white space Tutorial to be given at the March 2009 Plenary Session**

# Coexistence Tutorial Outline

- **Terminology**
- **Coexistence Scenarios**
- **Coexistence Metrics**
- **Possible Coexistence Mechanisms**

# Coexistence Terminology

- **TV Band Device** – An unlicensed wireless device operating in the TV white space, according to the FCC R&O
- **Coexistence** – Effective common use of the spectrum among networks of TV band devices
- **Primary User Protection** – Methods of ensuring that the TV band devices do not cause harmful interference to licensed services
  - An important topic but distinct from coexistence between TV band devices
- **Coexistence Scenario** – A description of the two (or more) networks of TV band devices including location, power, MAC/PHY layer, and other information to describe the “problem”
- **Coexistence Metric** – A measure of how well two (or more) networks coexist. Examples include changes in throughput and latency
- **Coexistence Mechanism** – A technique to provide effective sharing of the spectrum between networks of TV band devices. Examples include DFS, TPC, listen before talk, TDMA, Message-based Spectrum Contention, etc.



## Network Class Definitions in this Document

- **WRAN**
  - Fixed outdoor base station serving fixed clients (e.g. 802.16, 802.22)
- **WMAN**
  - Fixed outdoor base station serving indoor and outdoor portable clients
    - Could include 802.11 and 802.16 type networks
- **WLAN**
  - Mode II portable Access Point (AP) serving Mode I portable clients
  - AP must have Internet access and geo-location
    - Could include either an 802.11 and an 802.15 type network
- **WAHN (Wireless Ad-Hoc Network)**
  - Portable Mode I devices
    - No Internet Access
  - Sensing Only operation
    - Could include either an 802.11 or an 802.15 type network

# Interference mitigation and related parameters

- **Wall isolation**
  - Between 10-30 dB depending upon wall structure
- **Adjacent channel rejection**
  - Depends of masks and receive filters; 20...55dB
- **Receiver blocking**
  - Beyond the first adjacent channel; degradation of sensitivity levels
    - Cause: transmissions of other devices:
      - Are not attenuated sufficiently by the receiver filter (receive filter selectivity problem)
      - Effects of the out-of-band emissions at relatively low distances (transmitter mask problem)
    - 6dB degradation in sensitivity starting at relatively low interference levels: -60dbm
- **Receiver saturation**
  - Nonlinear effect of saturating the RF front-end
  - WLAN/WAHN devices are designed for better resistance to saturation, but higher sensitivity levels
  - WRAN/WMAN devices have lower resistance to saturation
    - Due to better sensitivities intended for large area deployments; 802.16: -30 dBm; 802.22: -8dBm

## A Few Coexistence Scenarios

- Scenario Limited to Geometry and Class of Networks

<b>Coexistence Scenario</b>	<b>Network A</b>	<b>Network B</b>
<b>1</b>	<b>WRAN</b>	<b>WMAN</b>
<b>2</b>	<b>WRAN or WMAN</b>	<b>WLAN or WAHN</b>
<b>3</b>	<b>WLAN</b>	<b>WAHN</b>

# Coexistence Scenario 1

- **WRAN and WMAN base stations similar TX power and antenna gain**

	<b>WRAN Client (Fixed)</b>	<b>WMAN Client (Portable)</b>
<b>TX Power</b>	<b>26 dBm</b>	<b>20 dBm</b>
<b>Antenna Gain</b>	<b>10 dB</b>	<b>0 dB</b>
<b>Building Penetration</b>	<b>0 dB</b>	<b>15 dB</b>

- **WRAN has approximately 30 dB better uplink**
- **WRAN has a much larger cell size**
- **Coexistence problems:**
  - Un-synchronized down-link and up-link operation

# Coexistence Scenario 1

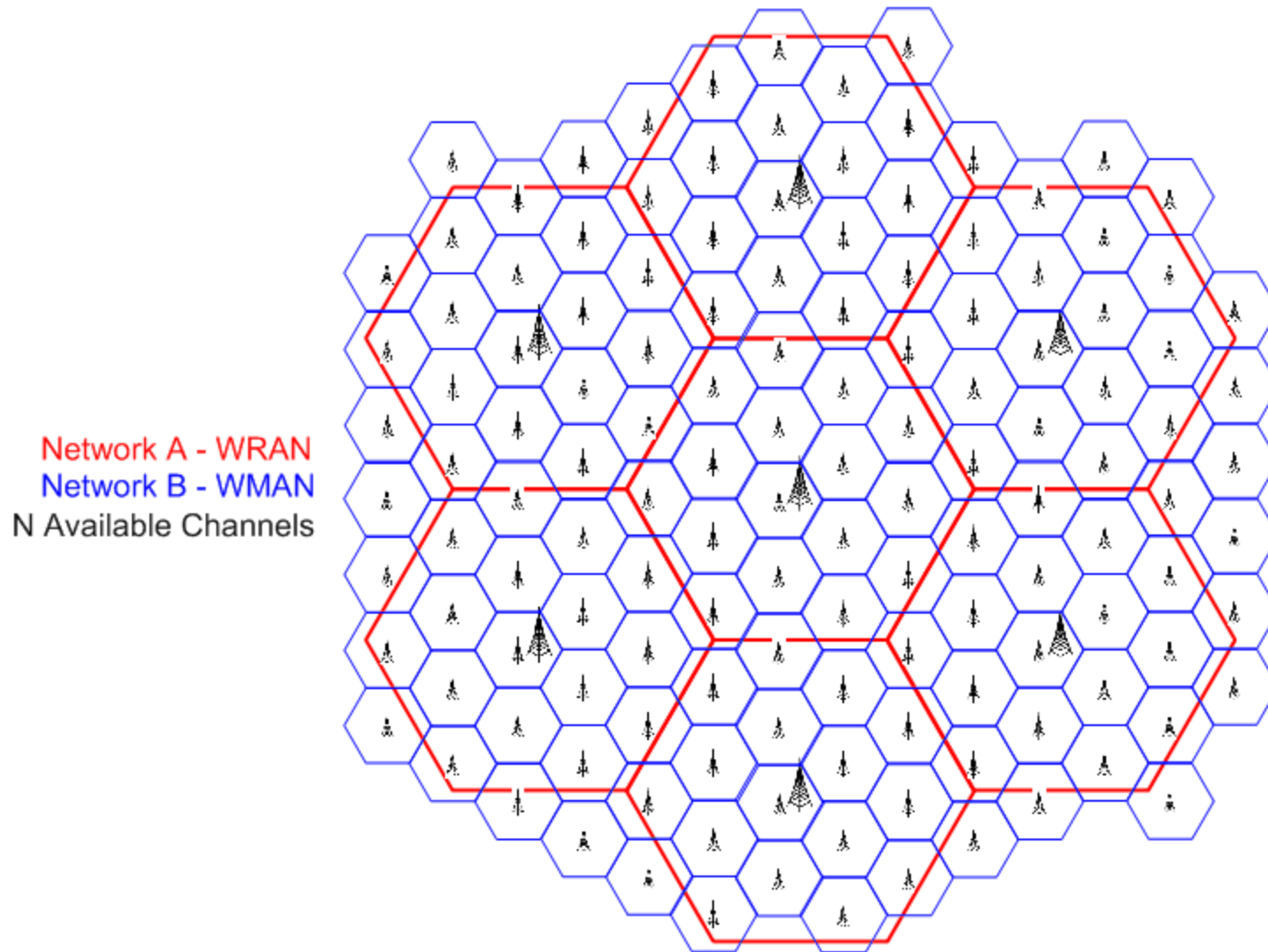

Network A - WRAN  
Network B - WMAN  
N Available Channels

## Coexistence Scenario 2

- **WRAN or WMAN outdoor base stations**
- **Either**
  - WRAN outdoor client
  - WMAN indoor client
  - WMAN outdoor client
- **WLAN or WAHN**
  - Indoor clients
  - Indoor Access Points

## Coexistence Scenario 2

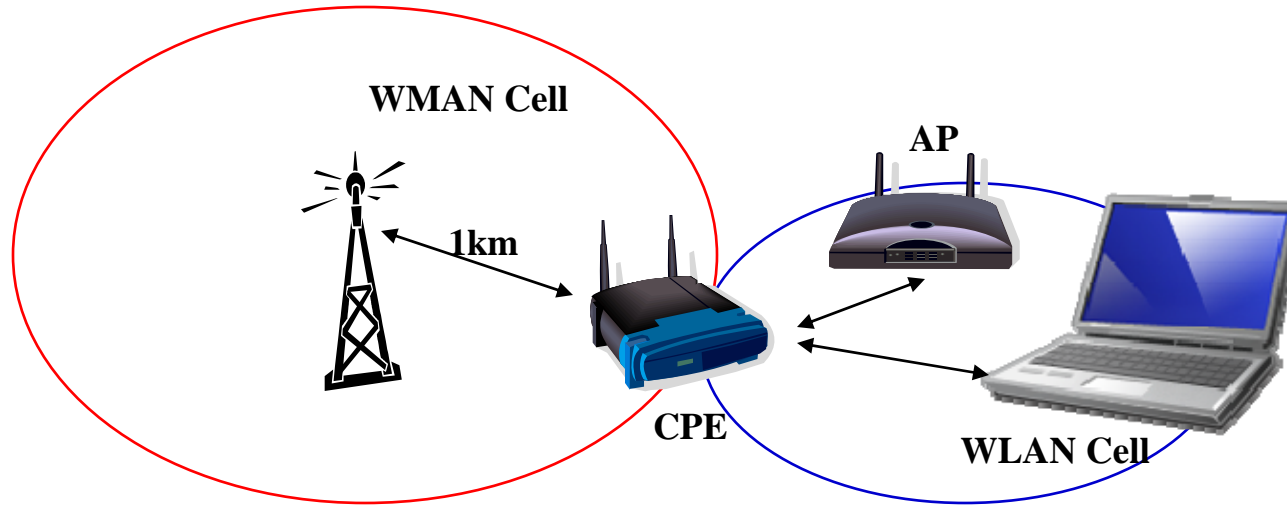

- **The CPE is a terminal in the WMAN cell**
- **In its vicinity operates a WLAN cell**
  - Both AP and STA interfere with the receiver of the WMAN/WRAN cell
  - Interference problems: on the same channel, from adjacent channels, from blocking in other channels, from saturation in the entire band

## Coexistence Scenario 3

- **WLAN indoors**
- **WAHN indoors**
- **Possible wall penetration between networks**
  - Adjacent apartments
  - Another room in the home

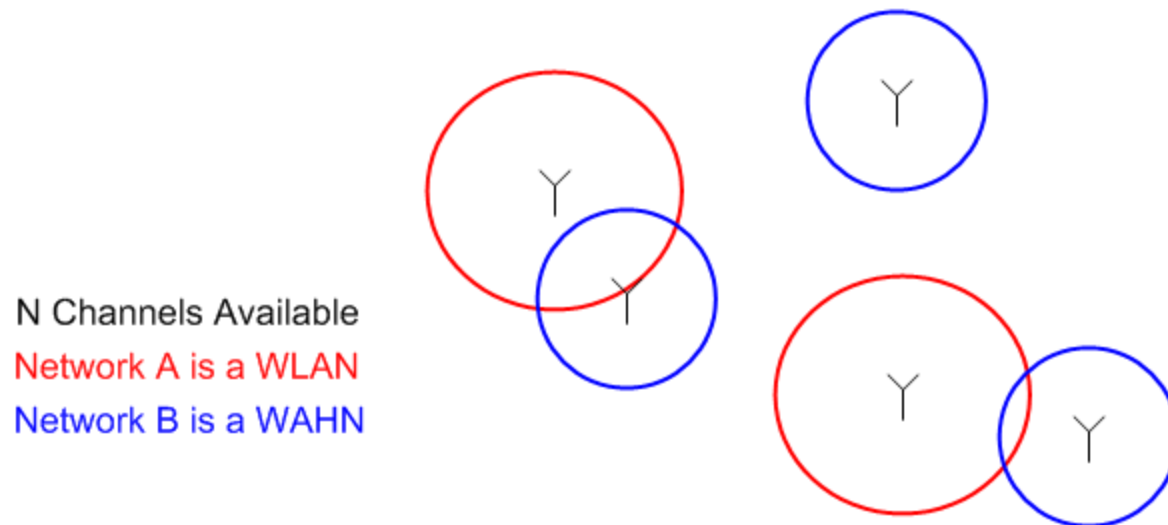



## Coexistence Metrics

- **Hidden node probability**
  - Clear channel assessment may not detect all nodes
- **Change in mean throughput**
  - Throughput with no interference from other network minus throughput with interference from other network normalized by throughput without interference from other network
- **Change in mean latency**
  - Latency with interference from other network minus latency without interference from other network normalized by latency without interference from other network

## Possible Coexistence Mechanisms

- **DFS (Dynamic Frequency Selection)**
  - Limited by number of available channels and inter-channel interference
- **Transmit power control**
- **Listen-before-talk behavior**
- **Time division multiplex different 802 technologies**
  - Based on 802.16h
  - Synchronization with the GPS clock entity or IEEE 1588 or IETF network time protocol entity
  - Long enough to let every technology work
  - Variants may be designed for specific pairs of interfering technologies
- **Message-based on-demand Spectrum Contention**
  - Adopted in IEEE 802.22 draft standard.
  - Based on coexistence beaconing that carries coexistence messages.
  - Designed for fair, low-overhead, QoS-aware spectrum sharing.
- **Control through a centralized coexistence manager using either 802.21-like concepts or 1900.4 concepts**

# Time Division Multiplex Mechanism



- **A specific technology will not be interfered by other technology during its Master slot**
- **During the Common operation only the technology not suffering from interference will be active**
- **During the Master time slot the coexistence mechanisms are according to the MAC approach of each technology**
  - 802.11 – Contention based
  - 802.16, 802.22 – Scheduled

# Interference Control using Messaging

- **Inter-system communication based on messages**
  - Higher layers messaging
  - Common PHY/MAC may be costly
  - Media specific messaging to a common network server
- **Transmitter identification**
  - MAC and/or Network address
- **Interferer identification**
- **Power reduction request**
- **Channel change request**
- **Coexistence data-base**
  - In relation to the FCC-defined data-base
  - To be added: MAC / Network address of each fixed transmitter

# Message-based Spectrum Contention

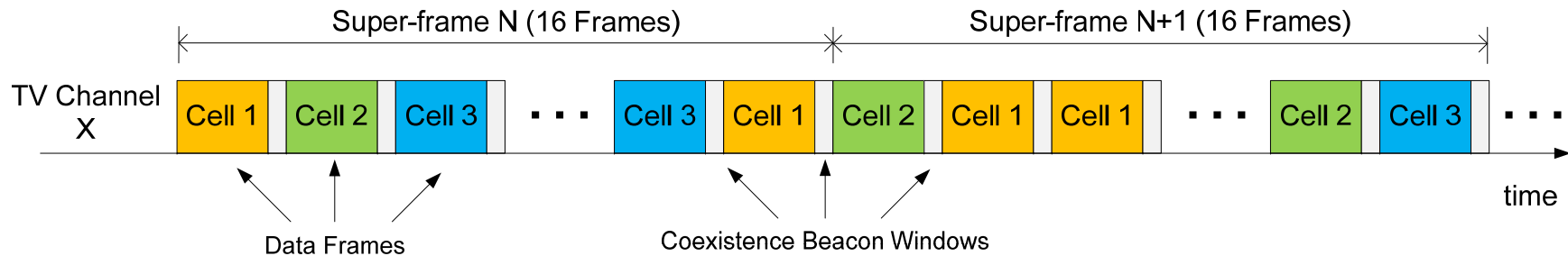

- **Multiple TVBD cells share a TV channel on a dynamic (on-demand) basis.**
- **Each TVBD cell has an exclusive access to a set of data frames within a super-frame.**
- **TVBD cells exchange contention messages, containing random contention numbers, to determine their rights of data frame access.**
  - The winner of a contention (i.e. comparison of contention numbers) will occupy a target data frame.
- **Spectrum contention messages are exchanged in the synchronized coexistence beaconing windows or through the backhaul.**

## Conclusions

- **Support for coexistence mechanisms so that multiple technologies can effectively utilize the spectrum is important**
- **Recommendation**
  - Assign to the 802.19 TAG the task of studying possible coexistence mechanisms in the TV white space, and that any person attending the TAG meeting be allowed to vote on motions relating to this matter

## References

- Steve Shellhammer, *Coexistence in TV White Space*, SG-08/06r0
- Steve Shellhammer, *Possible TV White Space Coexistence Tasks*, SG-09/02r3
- Ivan Reede, *Interoperability versus Coexistence*, SG-09/20r1
- Paul Houze, *IEEE 1900.4 Standard for heterogeneous Networks in Dynamic Spectrum context*, SG-09/22r0
- Gerald Chouinard, *Coexistence Matrix among potential TV White Space systems*, SG-09/25r0
- Steve Shellhammer, *Coexistence Scenarios*, SG-09/29r2
- Hiroshi Harada and Stanislav Filin , *White Space Communication Enabled by IEEE Standard 1900.4*, SG-09/31r0
- Juan Carlos Zuniga and Joseph Kwak, *802.21 Media Independent Coexistence*, SG-09/32r2
- Mariana Goldhamer, *Mixed cell coexistence scenario*, SG-09/33r0
- Gerald Chouinard, *Mutual interference between 802.22 CPE and Portable*, SG-09/43r0

# TV Whitespace Common Functions across IEEE 802 - Tutorial

Date: 2009-02-27

**Authors:**

<b>Name</b>	<b>Company</b>	<b>Address</b>	<b>Phone</b>	<b>E-mail</b>
Richard Paine	Self		+12068548199	<a href="mailto:richard.h.paine@gmail.com">richard.h.paine@gmail.com</a>
Mark Cummings	enVia	348 Camino al Lago Atherton, Ca 94027	+16508544406	<a href="mailto:markcummings@envia.com">markcummings@envia.com</a>



# Challenges

- **FCC/OFCOM/EC allocation of TV Whitespace**
- **New form of license exempt spectrum management (Master Data Base+Sensing)**
- **Growing Requirements**
  - Increasing wireless traffic requirements
  - Multiple services using multiple 802 standards inside 802 community
  - High variety of services inside 802 community
  - High variety of use and business cases
- **Cross 802 Technical Challenges**
  - Fundamental differences between 802 technologies
    - 802.16, 802.20, 802.22 are time based and need synchronization
    - 802.11 and 802.15 are power and frequency based and are Listen Before Talk (LBT)
  - Database Approach
  - End-to-End Security

## Cross 802 and WhiteSpace (WS)

- **ALL 802 groups affected by cross 802 approaches**
- **Groups affected by wireless 802 Whitespace:**
  - .1 (common MAC functionality across 802)
  - .11 (license exempt use of WS frequencies for WLANs)
  - .15 (license exempt use of WS frequencies for WPANs)
  - .16 (license exempt use of WS frequencies for WMANs)
  - .20 (license exempt use of WS frequencies for cellular WMANs)
  - .21 (Mechanism for WS Media Independent Handover)
  - .22 (licensed or license exempt use of WS frequencies for WRANs)
- **Cross 802 Sphere of Influence**

# Cross 802 Functionality Not Addressed Yet

- WS DB Information Requirements
  - Location information (802.11 has location in 11k, 11y, and 11n)
  - Technology used
  - Linkage between MAC and Network address
  - RF parameters
  - Channel center and width
- End-to-End Security (802.21 working on layer 2 security presently, not addressing PHY security)
- Secure Database Access
- Database Privacy Protection
- Radio PHY - Time vs Frequency/Power

# E2E for Interface to Higher Layers

- **Problem**

- 802 has limited itself to lower levels (PHY and MAC) in past
- Interface between the MAC to Data Link and Network layer not defined
- Cooperation with IETF, SCC41 is possible but:
  - Long time scales
  - Eventually will happen after ending the specific 802 project
    - **Broken link**

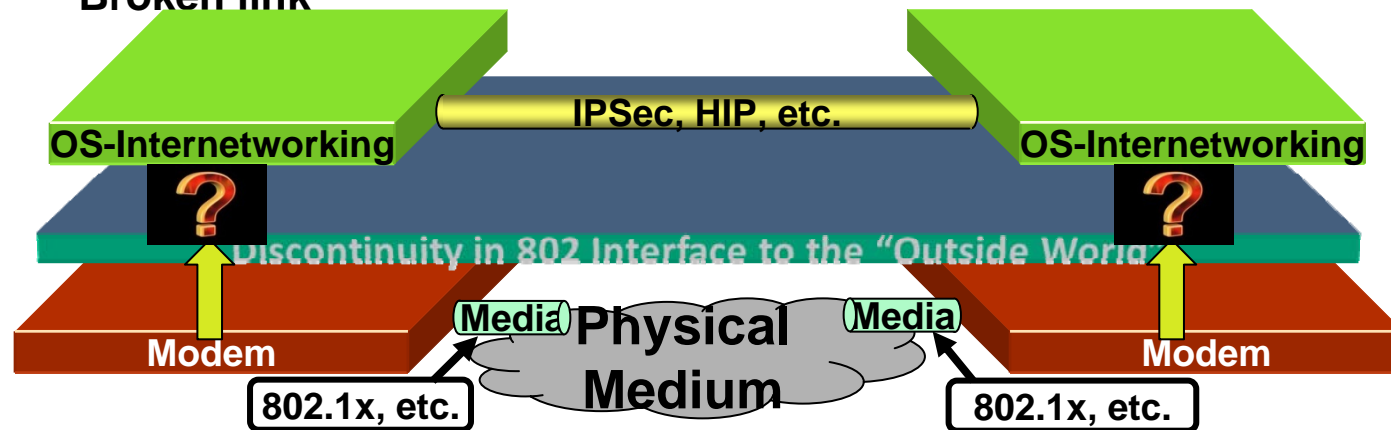

Discontinuities including both Wireless media (802.11/802.15/802.16/802.22) and Wired media (802.3/802.5

## Conclusions

- **Cross 802 Technical Aspects**
  - Examine WS cooperation between 802 devices
  - Examine 802 End-to-End security responsibilities (PHY and MAC)
  - Cross 802 FCC WS approach for 802 technologies
    - Secure Datastore
    - Media Independence
- **Common Organizational Aspects – two recommendations**
  - Create 802 Next Generation TAG for defining cross 802 cognitive detection, low level radio coexistence, and End-to-End security
    - *Liaison with non-802 standards organizations for PHY and MAC*
  - 802 IEEE/IETF Task Force for higher layer protocols
    - *Interface to higher layers with IETF*
    - *DB Access Design*

# TVBD common functions across IEEE 802

Date: 2009-03-01

## Authors:

Name	Company	Address	Phone	E-mail
Mariana Goldhamer	Alvarion	Tel Aviv, HaBarzel St., 21A, Israel	+97236456241	mariana.goldhamer@alvariaron.com

**Notice:** This document has been prepared to assist IEEE 802.19. It is offered as a basis for discussion and is not binding on the contributing individual(s) or organization(s). The material in this document is subject to change in form and content after further study. The contributor(s) reserve(s) the right to add, amend or withdraw material contained herein.

**Release:** The contributor grants a free, irrevocable license to the IEEE to incorporate material contained in this contribution, and any modifications thereof, in the creation of an IEEE Standards publication; to copyright in the IEEE's name any IEEE Standards publication even though it may include portions of this contribution; and at the IEEE's sole discretion to permit others to reproduce in whole or in part the resulting IEEE Standards publication. The contributor also acknowledges and accepts that this contribution may be made public by IEEE 802.19.

**Patent Policy and Procedures:** The contributor is familiar with the IEEE 802 Patent Policy and Procedures <<http://iee802.org/guides/bylaws/sb-bylaws.pdf>>, including the statement "IEEE standards may include the known use of patent(s), including patent applications, provided the IEEE receives assurance from the patent holder or applicant with respect to patents essential for compliance with both mandatory and optional portions of the standard." Early disclosure to the TAG of patent information that might be relevant to the standard is essential to reduce the possibility for delays in the development process and increase the likelihood that the draft publication will be approved for publication. Please notify the Chair <[shellhammer@ieee.org](mailto:shellhammer@ieee.org)> as early as possible, in written or electronic form, if patented technology (or technology under patent application) might be incorporated into a draft standard being developed within the IEEE 802.19 TAG. **If you have questions, contact the IEEE Patent Committee Administrator at <[patcom@ieee.org](mailto:patcom@ieee.org)>.**

# Challenges

- **New form of LE spectrum management (FCC Master Data Base)**
- **No more free spectrum**
  - Therefore, we need to use “available” spectrum allocated for COMMON usage
- **FCC rules mix the data-base approach with spectrum sensing**
  - Data-base approach – **industry and FCC clearly prefers this approach**
  - Sensing is still required in 15.711 (a)(2) “and shall rely on spectrum sensing to identify available television channels to provide interference protection to all other operations”
- **Multiple services using multiple 802 standards inside 802 community**
- **High variety of use and business cases**
- **To solve:**
  - Use the TVWS new spectrum efficiently
  - Optimally accommodate all the provided services and business cases

## Desired E2E common functionality for future standardization

- **Support for the FCC required spectrum sensing and future cognitive devices**
  - Synchronized silence intervals
  - Cognitive beacon design
- **Inter-system coexistence**
  - Media access procedures for interference separation
  - Technology-independent information and protocols
    - Inter-system Coexistence Protocol, assuming distributed communication
    - Centralized information source including radio parameters
    - Support for centralized TVBD manager
- **Access to the FCC-defined data-base**
  - Protocol and security



# Enablers for spectrum sensing – Silence and Beacons



- **Synchronized silence**
  - GPS or Network-based synchronization: IEEE 1588, Network Time Protocol (NTP)
- **Cognitive beacons**
  - 802.22 is the natural focal point for this activity
- **There is an interaction between the Silent Slots design and Beacon design**
  - Synchronization
  - Duration
  - Repetition interval
- **Process and objectives**
  - Define cross—802 silence and beacons
  - Higher interaction in 802 for accommodating all the intended services by all the interested groups
  - Common meetings
  - Shared file access

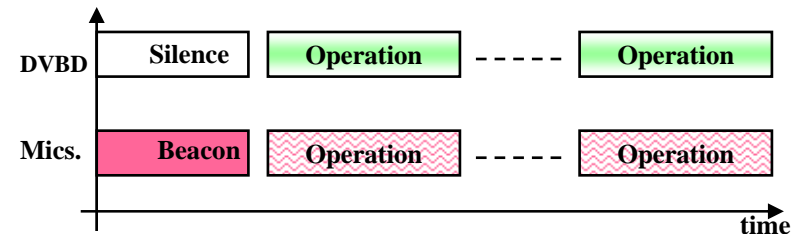

# Coexistence between TVBDs

- **Scope**
  - Allow ALL the 802 technologies to optimally serve their markets
  - Optimally use of the spectrum
- **High interference environment**
  - Relatively lower path loss and building penetration
  - Reduced number of free channels in dense geographies
- **Approach**
  - Cooperation and coordination
    - Coordinated MAC approach for interference avoidance
    - Technology-independent Coexistence Protocols
    - Centralized Server for distribution of TVDB deployment information
    - Centralized TVBD Manager



# Interference avoidance – Medium Access

- **Dynamic Channel Selection (DCS/DFS) first**
  - May not resolve the problem in dense area
  - Does not resolve the harmful interference to WMAN+WRAN created by WLANs
- **Enhanced Protocols for Medium Access**
  - LBT not good enough
    - Energy detection levels are at least 10dB higher than sensitivity levels
  - Synchronized time-frequency slots with reduced interference to protect WRAN/WMAN applications
    - Similar time-division approach in 802.16h and 802.22
- **Process for a common standardization of the TVBD Medium Access protocol**
  - Requires a new frame-work in 802



# Technology-independent Coexistence Protocol based on distributed inter-BS/AP communication

- **Coexistence Protocol**
  - Experience in 802.16h, 802.22
    - 802.16 has defined the M-SAP, C-SAP and PRIMITIVES for the higher layer Coex. Protocol
  - Information distribution
    - Occupied channels and location
    - RF and deployment parameters
    - Active coexistence information
  - Control messages
    - Channel resource negotiation
    - Interferer identification and power control
    - Coexistence Frame related
    - Pro-active coexistence scheduling
  - Access to a common data-base
  - TVBD Manager support
- **Process for standardization**
  - Required a new frame work in 802 for defining higher-layer coexistence protocols



# FCC data-base, Shared Server, TVBD Manager

- **Protocol at Network layers**
  - Real-time access to FCC data-base
  - Shared Server to enforce cognition related to 802 TVBDs
  - TVBD Manager may assign channels, time-slots, etc.
- **Security problems**
  - Denial of service - attacks
  - False data-base entries which can block an operational channel, etc.
- **802 End-to-End Considerations**
  - Coordinating cross 802 for management and control procedures and SAPs, MIBs, etc.
  - Developing End-to-End interfaces to eventual external standards organizations (IETF, etc.) or an 802-designated WG
- **Process for standardization**
  - Requires a new frame-work in 802 for coordinating cross-802
    - Designate an 802 Group (802.1 or 802.21 ?)
  - Focal point for cooperation with external standard organizations



# E2E solution for cross-802 Coexistence support

- **Problem**

- 802 limits itself to lower levels
- Cooperation with IETF is possible but:
  - Very long time scales, starting AFTER 802 approval
  - **Broken link**
    - **Has IETF expertise in coexistence protocols ?**
    - **Does IETF want to deal with Coexistence ?**



- **Process**

- Assign a WG for dealing with these issues
  - Primitives to be provided by the interested WGs
    - 802.16h has already defined an extensive set
  - Add headers for IP encapsulation
    - **802 should not broke an E2E solution for a trivial technical issue**

## Conclusions – technical aspects

- **There is a clear requirement for examining cooperation between 802 devices**
- **Synchronized operation is suitable for supporting sensing, WMAN/WRAN applications and beacon detection**
  - This approach is in conflict with the existing 802.11 operation in which the Beacons from different APs are not synchronized
- **Coexistence at low layers should use an 802 coordinated approach**
  - For some protection of WRAN and WMAN applications
- **New EC Study Groups may be needed**
  - Cross 802 Coexistence
  - Higher layer protocols, including security aspects

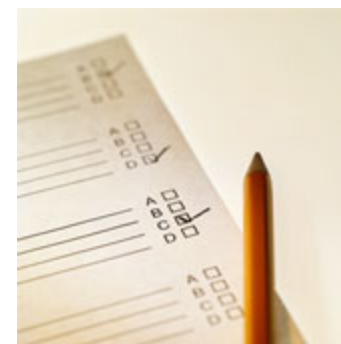

## Conclusions – organizational aspects

- **New EC Study Group should be created**
  - The EC should create a Study Group specifically to indentify possible protocol solutions for TVBD coexistence protocols at low and higher levels. Solutions sets would be identified in adequate detail to allow the EC to evaluate creation of subsequent specification activity (PAR and Criteria).
- **EC should give guidance**
  - Cross-802 framework for defining the higher level protocols
    - Coexistence protocols
      - May include access to specific Data-bases and TVBD Control Servers
    - FCC Server access, TVBD Data-base access, TVBD Control Server





# Security Tutorial Material

Date: 2009-03-10

Authors:

Name	Affiliations	Address	Phone	email
Alex Reznik	InterDigital	781, 3 <sup>rd</sup> Ave. King of Prussia, PA 19406, USA	610-878-5784	Alex.Reznik@interdigital.com
Ranga Reddy	US Army			Ranga.Reddy@us.army.mil
Michael Williams	Nokia		650-823-0165	Michael.G.Williams@nokia.com
Richard Paine	Self	6115 72 <sup>nd</sup> Dr NE Marysville, Wa 98270	206-854-8199	richard.h.paine@gmail.com

**Notice:** This document has been prepared to assist IEEE ECSG on TV White Space. It is offered as a basis for discussion and is not binding on the contributing individual(s) or organization(s). The material in this document is subject to change in form and content after further study. The contributor(s) reserve(s) the right to add, amend or withdraw material contained herein.

**Release:** The contributor grants a free, irrevocable license to the IEEE to incorporate material contained in this contribution, and any modifications thereof, in the creation of an IEEE Standards publication; to copyright in the IEEE's name any IEEE Standards publication even though it may include portions of this contribution; and at the IEEE's sole discretion to permit others to reproduce in whole or in part the resulting IEEE Standards publication. The contributor also acknowledges and accepts that this contribution may be made public by IEEE 802.

**Patent Policy and Procedures:** The contributor is familiar with the IEEE 802 Patent Policy and Procedures <<http://iee802.org/guides/bylaws/sb-bylaws.pdf>>, including the statement "IEEE standards may include the known use of patent(s), including patent applications, provided the IEEE receives assurance from the patent holder or applicant with respect to patents essential for compliance with both mandatory and optional portions of the standard." Early disclosure to the TAG of patent information that might be relevant to the standard is essential to reduce the possibility for delays in the development process and increase the likelihood that the draft publication will be approved for publication. Please notify the Chair <[matthew.sherman@baesystems.com](mailto:matthew.sherman@baesystems.com)> as early as possible, in written or electronic form, if patented technology (or technology under patent application) might be incorporated into a draft standard being developed within the IEEE. **If you have questions, contact the IEEE Patent Committee Administrator at <[patcom@ieee.org](mailto:patcom@ieee.org)>.**

## Abstract

- **This presentation contains the Security material for the TV white space Tutorial to be given at the March 2009 Plenary Session**

# Outline

- **Top-level security goals in whitespaces and a general approach**
- **High-level threat analysis**
- **Ad-hoc recommendations**

# Security Goals and General Approach

- **Within the context of white spaces, security design needs to focus on two goals:**
  - Primary goal: Protection of incumbents
  - Secondary goal: Protection of unlicensed users
    - The number of issues and technologies is larger than with protection of incumbents
    - Requires a comprehensive approach
  
- **Approach to Security**
  - The ad-hoc recommends that an end-to-end security analysis be used in developing security aspects of white space technologies
  - Within 802 this means a focus on the following
    - The interfaces required for support of higher-level security technologies, such as data/application security, secure identity protocols, device security, etc.
    - Support of security technologies as discussed below

# Threat Analysis: High Level Threats

- **Illegal Use of Spectrum**
  - Causing harmful interference to incumbents
- **Denial of Service between Secondary Users**
  - Threats to coexistence protocols between secondary devices
    - e.g. Stealing/hogging spectrum
- **Unauthorized disclosure or modification of “sensitive user/location” information**
  - Disclosure of user location
  - Modification of database info
- **“Sensitive user/location” information is not correct**
  - Registered incumbent or secondary user location
  - Database info poisoning
  
- **Sensitive user/location information may include**
  - User location information
  - User identity
  - Database registration/authentication parameters
  - Sensor measurements reported to the database by user
  - Interference report from the database
  - Etc.

# Threat Analysis

## Mapping Use Cases to Threats – Master Devices

Use Cases/Threats	4W Fixed	4W-4W fed by 100mW	4W-100 mW	100 mW (Registered Master)	100 mW (Un - registered Master)	50 mW (Sensing Only)	≤ 40 mW
Illegal Use of Spectrum	<b>X</b>	<b>X</b>	<b>X</b>	<b>X</b>	<b>X</b>	<b>X</b>	
DoS between Secondary Users	<b>X</b>	<b>X</b>	<b>X</b>	<b>X</b>	<b>X</b>	<b>X</b>	<b>X</b>
Disclosure/ Modification of “Relevant” Info	<b>X</b>	<b>X</b>	<b>X</b>	<b>X</b>	<b>X</b>		
“Relevant” Info Not correct	<b>X</b>	<b>X</b>	<b>X</b>				

# Threat Analysis

## Mapping Use Cases to Threats – Client Devices

Use Cases/Threats	4W Fixed	4W-4W fed by 100mW	4W-100 mW	100 mW (Registered Master)	100 mW (Un - registered Master)	50 mW (Sensing Only)	≤ 40 mW
Illegal Use of Spectrum		X			X	X	
DoS between Secondary Users	X	X	X	X	X	X	X
Disclosure/ Modification of “Relevant” Info	X	X	X	X	X		
“Relevant” Info Not correct	X	X	X				

## Threat Analysis: Caveats

- For the “50mW (Sensing Only)” and “ $\leq 40\text{mW}$ ” the *Disclosure/Modification of Relevant Info & Relevant Info Not Correct* threats, are not applicable as those devices will not make use of the database.
- The “ $\leq 40\text{mW}$ ” use case is not affected by the *Illegal Use of Spectrum* threat due to low power. Devices can operate in adjacent channels.
- Client devices cannot pose the *Illegal Use of Spectrum* threat in some use cases because the master chooses the spectrum, polls the database, and bears the responsibility for violation. The exception is when the master device is unregistered.
  - Given that registration for the lower power devices is not required. This also may be applicable for lower power networks operating in a mesh or peer to peer topology, where every device would be considered a master.



# Ad-Hoc Recommendations

- **Further Work**
  - Present recommendation represents the best that could be accomplished with a limited time-span of this SG
  - The contributors and other security ad-hoc participant recognize the need for a much more detailed analysis resulting in
    - A detailed use-case based threat analysis
    - Detailed recommendation for addressing identified threats
  - 802 should plan to further pursue this topic either in a separate SG or as part of other whitespace activities
  - Device security is an important requirement for protection of incumbents. Further study is needed to determine whether device security has an impact on 802.
  - Support for low-layer security should be investigated further
  - Support for sensor and location measurement security should be investigated further.
  
- **Protection of database information**
  - Protection of database information on the device and its transmission over the air interface links is recommended and appropriate techniques should be supported by 802
  
- **Privacy of Location and Identity**
  - Standards developed within IEEE 802 should support mechanisms and policies to ensure the privacy of a user/device location and identity

# 802.22 Presentation to the ECSG on White Space

**Author:**

Name	Company	Address	Phone	email
Gerald Chouinard	Communications Research Centre, Canada	3701 Carling Ave. Ottawa, Ontario Canada K2H 8S2	(613) 998-2500	gerald.chouinard@crc.ca

**Abstract**  
This contribution illustrates the work carried out by the 802.22 WG over the last 5 years in developing the Wireless Regional Area Network standard to be used in TV White Space.

**Notice:** This document has been prepared to assist IEEE 802.22. It is offered as a basis for discussion and is not binding on the contributing individual(s) or organization(s). The material in this document is subject to change in form and content after further study. The contributor(s) reserve(s) the right to add, amend or withdraw material contained herein.

**Release:** The contributor grants a free, irrevocable license to the IEEE to incorporate material contained in this contribution, and any modifications thereof, in the creation of an IEEE Standards publication; to copyright in the IEEE's name any IEEE Standards publication even though it may include portions of this contribution; and at the IEEE's sole discretion to permit others to reproduce in whole or in part the resulting IEEE Standards publication. The contributor also acknowledges and accepts that this contribution may be made public by IEEE 802.11.

**Patent Policy and Procedures:** The contributor is familiar with the IEEE 802 Patent Policy and Procedures <<http://standards.ieee.org/guides/bylaws/sb-bylaws.pdf>>, including the statement "IEEE standards may include the known use of patent(s), including patent applications, provided the IEEE receives assurance from the patent holder or applicant with respect to patents essential for compliance with both mandatory and optional portions of the standard." Early disclosure to the Working Group of patent information that might be relevant to the standard is essential to reduce the possibility for delays in the development process and increase the likelihood that the draft publication will be approved for publication. Please notify the Chair [Carl R. Stevenson](mailto:Carl.R.Stevenson@wk3c.com) <wk3c@wk3c.com> as early as possible, in written or electronic form, if patented technology (or technology under patent application) might be incorporated into a draft standard being developed within the IEEE 802.11 Working Group. **If you have questions, contact the IEEE Patent Committee Administrator at <[patcom@ieee.org](mailto:patcom@ieee.org)>.**

# Outline

- 1. The IEEE 802.22 WRAN Standard**
- 2. Coexistence among communication systems in TV White Space**
  - a) Protection of TV broadcasting
  - b) Protection of Part 74 wireless microphones
  - c) 802.22.1 wireless microphone beacon
  - d) Quiet periods for sensing
  - e) Self-coexistence among WRAN systems
- 3. Further observations**
  - a) DTV coverage protection
  - b) RF mask

# IEEE Standards Network Type

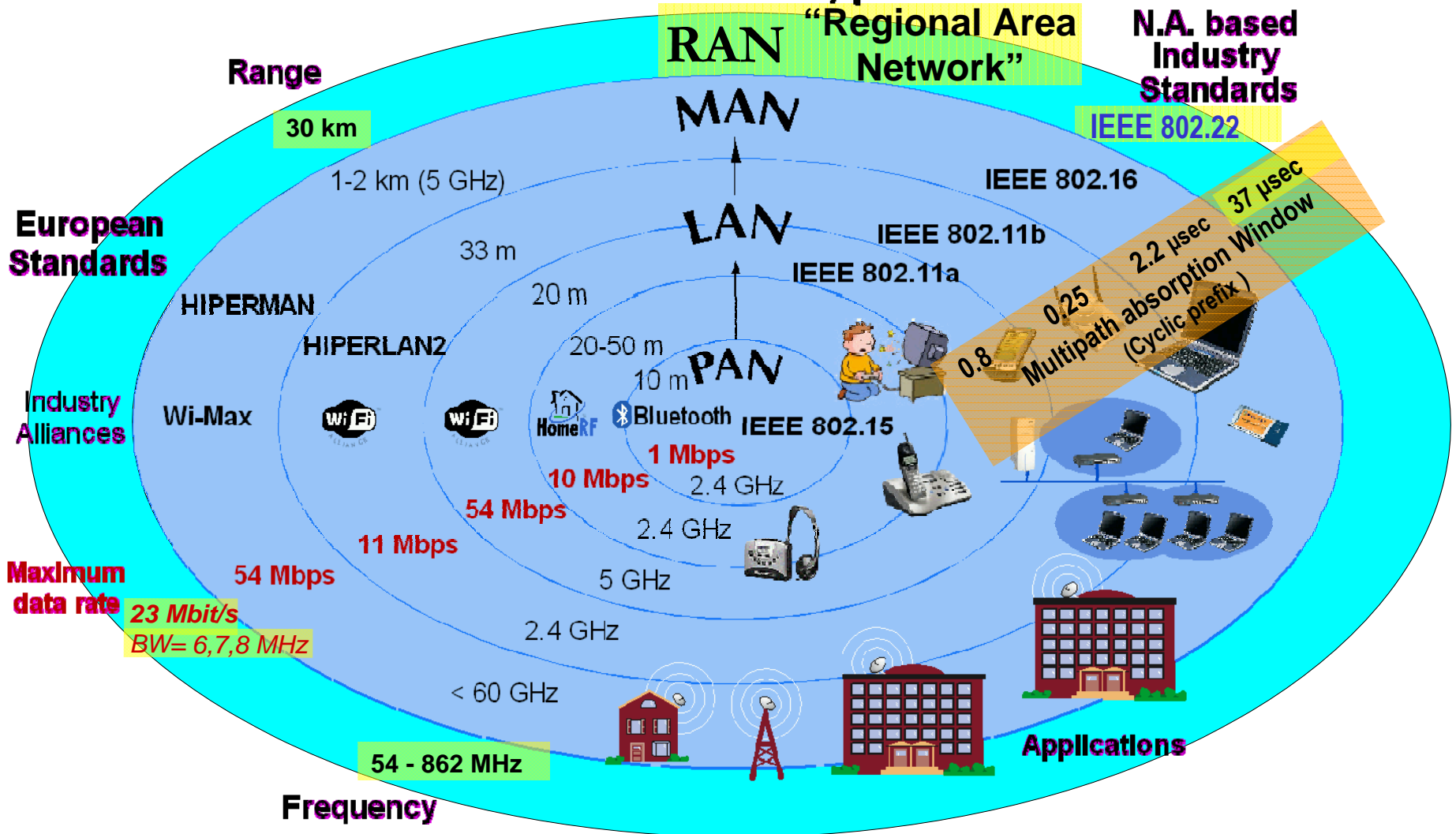

# Rural Broadband:

- Cable-modem / ADSL
- WiFi hot-spots in ISM bands
- Medium power wireless systems
- Higher power, lower frequency broadband access system

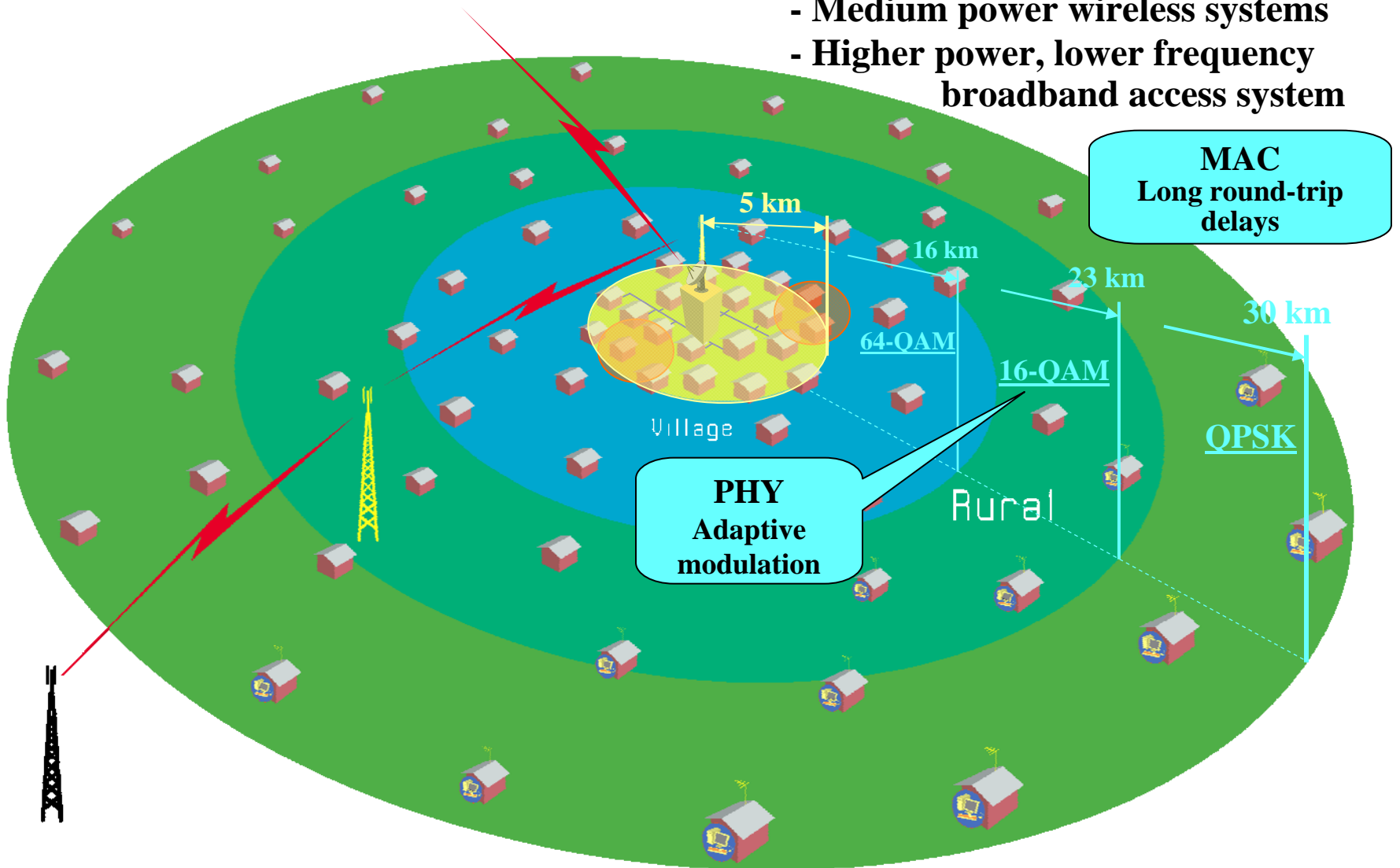

# Typical CPE installation (Fixed)

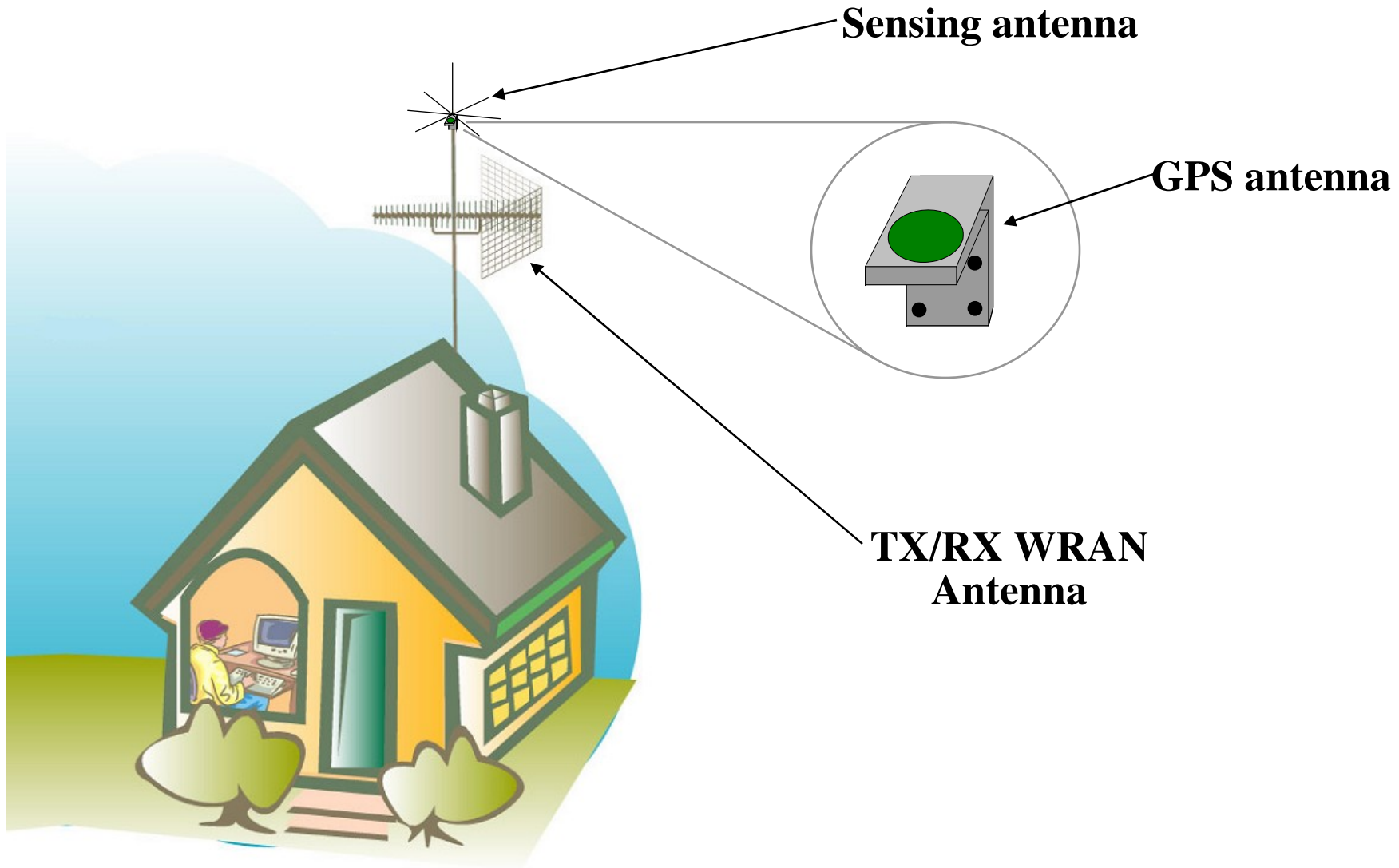

# 802.22 Frame Structure

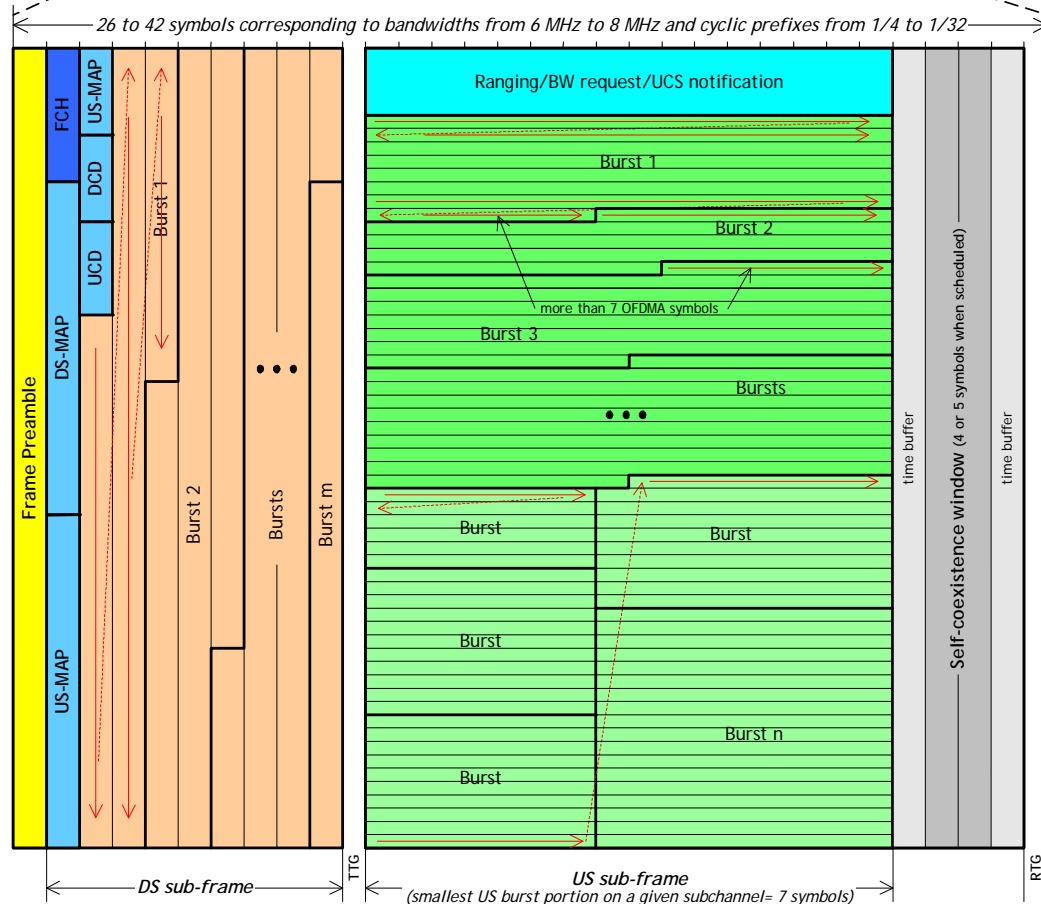
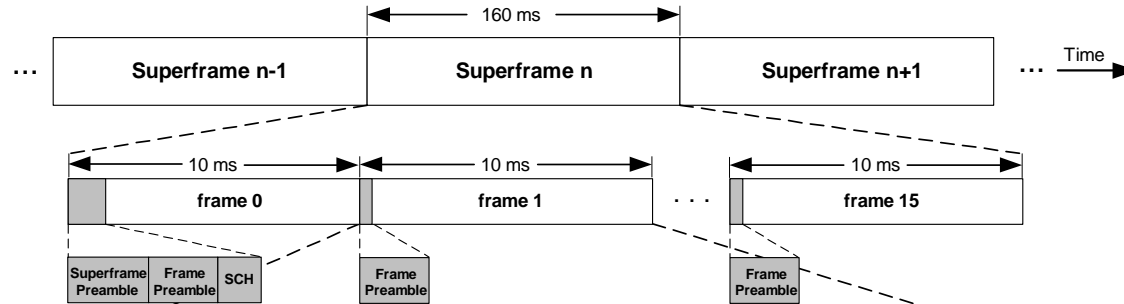

**Superframe  
= 160 ms**

**Frame  
= 10 ms**

**Superframe  
= 16 frames**

# 802.22 Reference Architecture

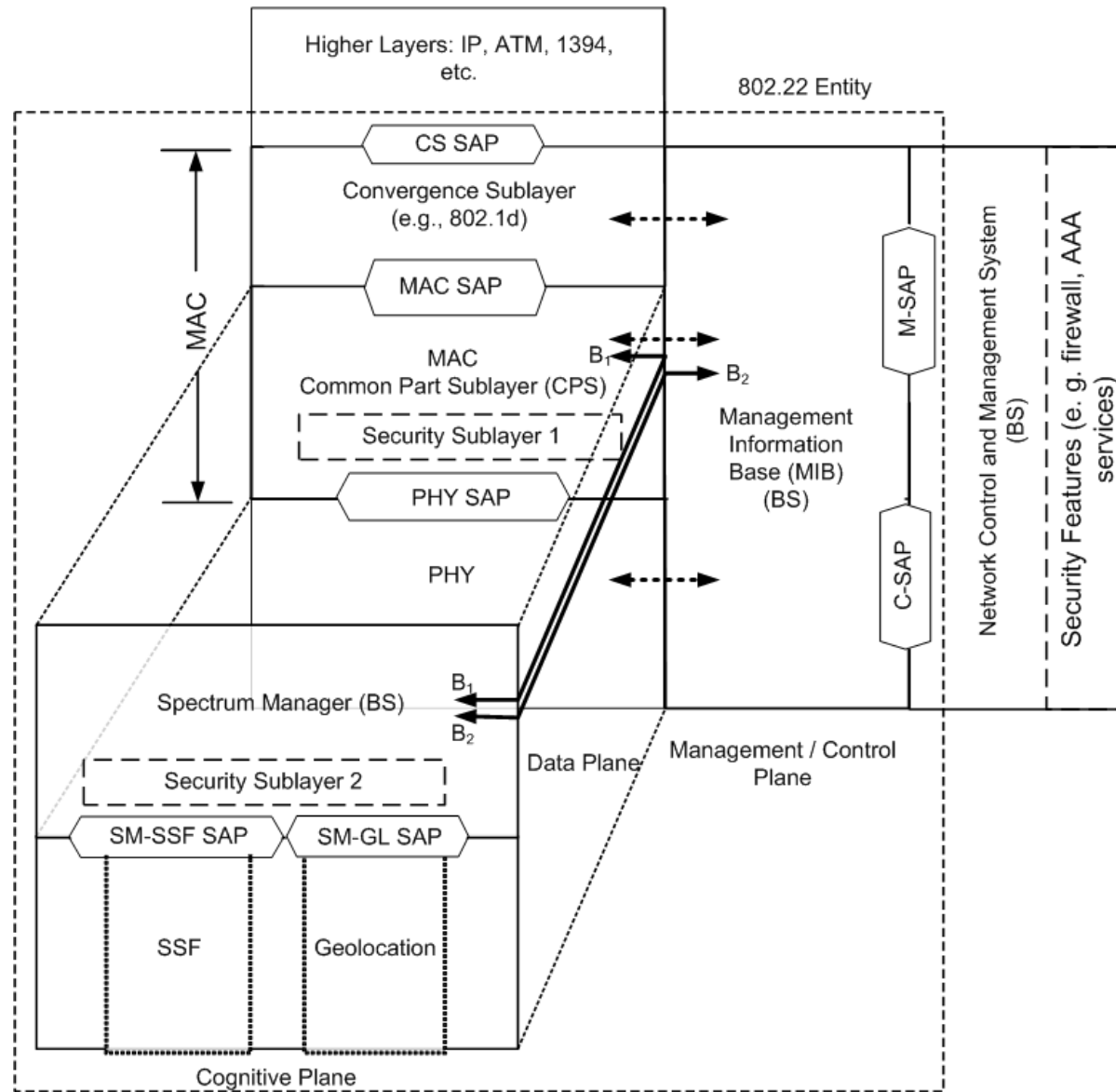



# Outline

1. **The IEEE 802.22 WRAN Standard**
2. **Coexistence among communication systems in TV White Space**
  - a) Protection of TV broadcasting
  - b) Protection of Part 74 wireless microphones
  - c) 802.22.1 wireless microphone beacon
  - d) Quiet periods for sensing
  - e) Self-coexistence among WRAN systems
3. **Further observations**
  - a) DTV coverage protection
  - b) RF mask

# Coexistence among communications systems in TV White Space

	DTV	Analog TV	Wireless Microphone	PLMRS	802.11	802.15	802.16	802.22	DOCSIS	etc.
802.11					802.11					
802.15						802.15				
802.16							802.16h			
802.22	802.22	802.22	802.22		SG-09-43r1	SG-09-43r1	SG-09-43r1	802.22		
DOCSIS										
etc.										

Incumbent protection

Coexistence

**Legend**

Protection of incumbents
Self-coexistence
Coexistence among IEEE 802 systems
Coexistence with non-IEEE 802 systems
Coexistence among non-IEEE 802 systems

Self-coexistence

# Outline

1. **The IEEE 802.22 WRAN Standard**
2. **Coexistence among communication systems in TV White Space**
  - a) **Protection of TV broadcasting**
  - b) Protection of Part 74 wireless microphones
  - c) 802.22.1 wireless microphone beacon
  - d) Quiet periods for sensing
  - e) Self-coexistence among WRAN systems
3. **Further observations**
  - a) DTV coverage protection
  - b) RF mask

# WRAN CPE and DTV protection

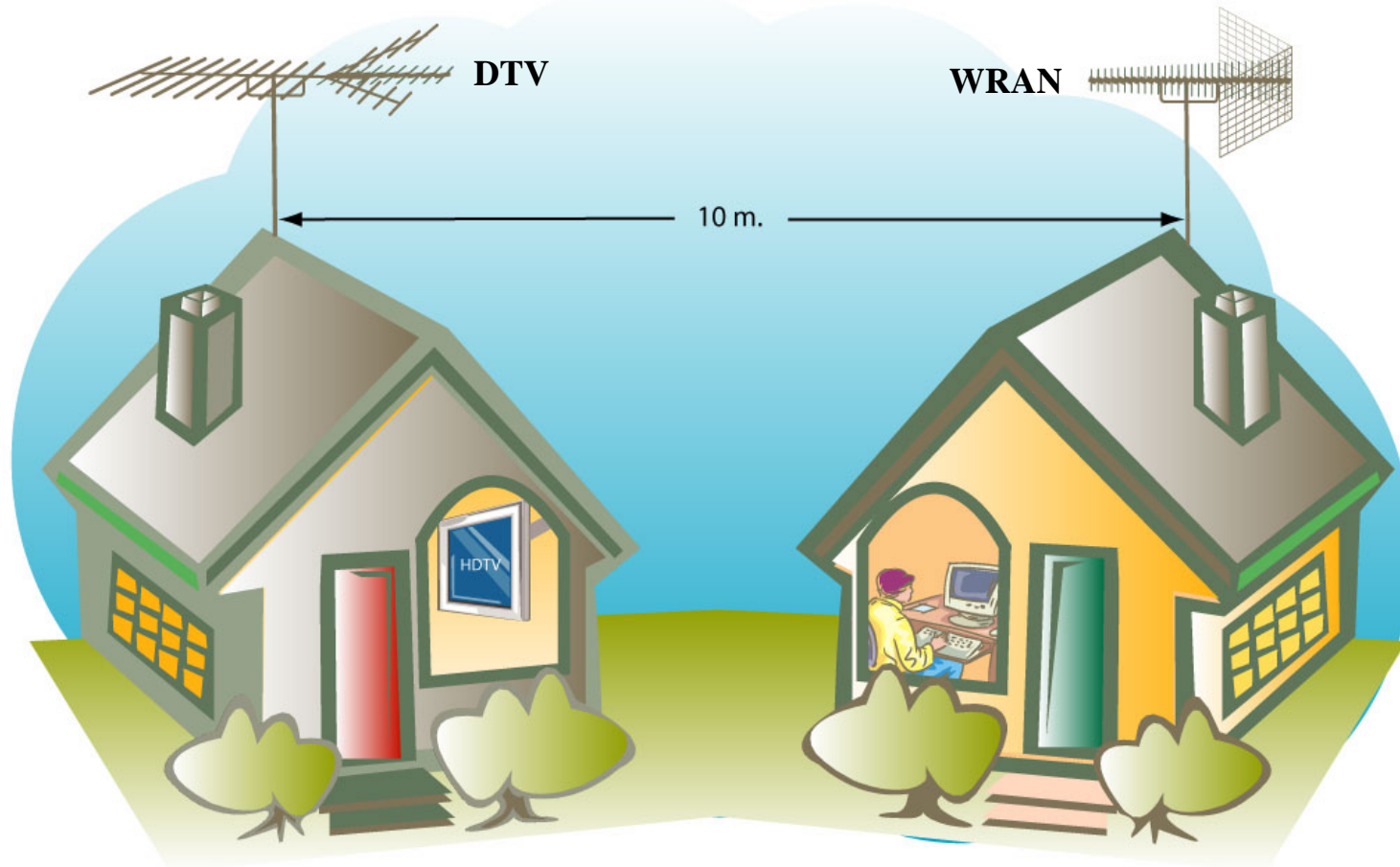

# Co-channel keep-out distance between DTV and 802.22 WRAN

<b>WRAN keep-out distance:</b>	
Minimum field strength:	41 dB(uV/m)
Protection ratio:	23 dB
CPE antenna front-to-back:	14 dB
Interfering field strength:	32 dB(uV/m)

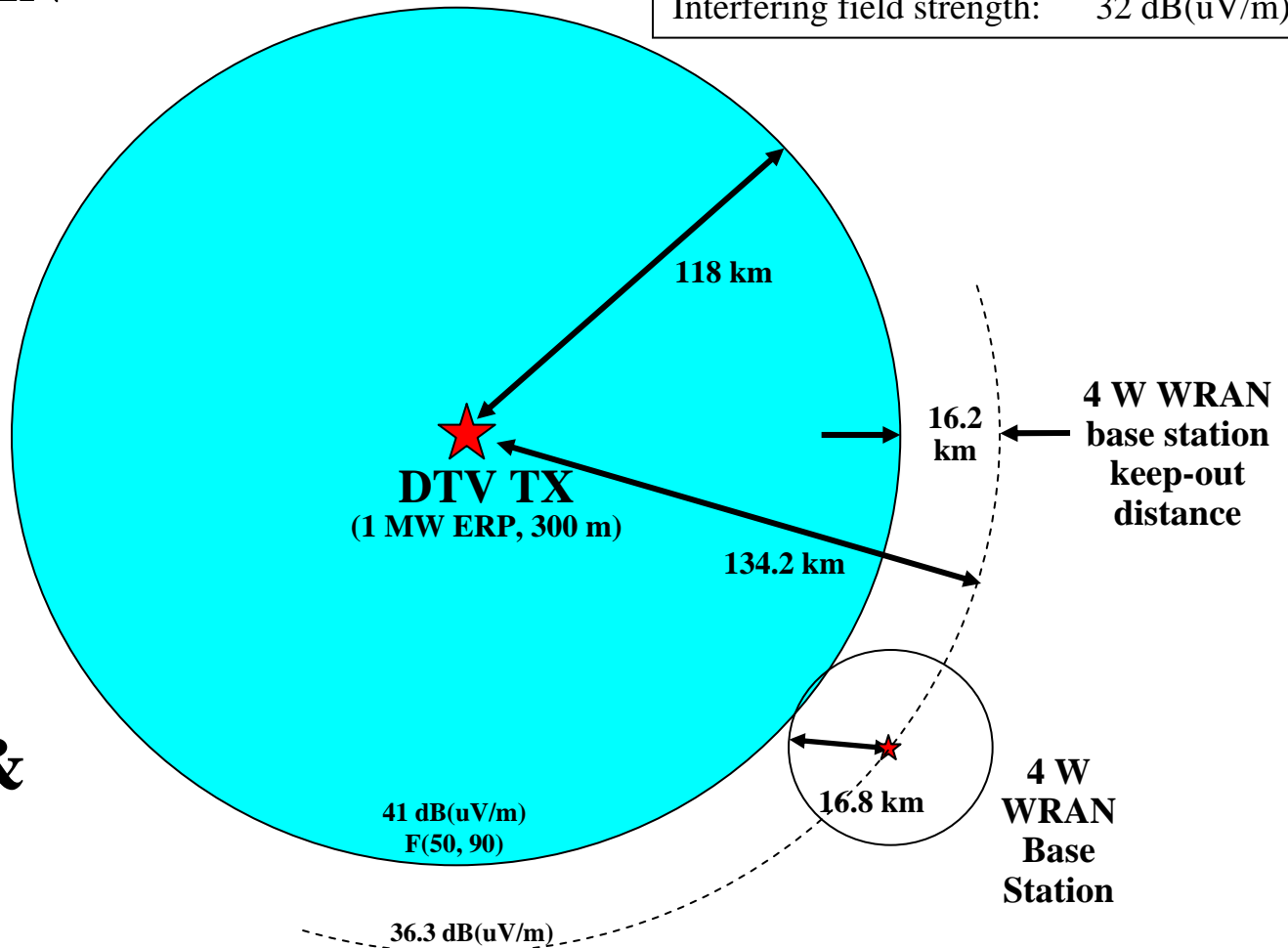

## Geolocation & Database

# TV sensing techniques studied by 802.22

- **Blind**
  - Energy detection
  - **Eigenvalue sensing (I2R)**
- **Multi-resolution (MRSS)**
- **Spectral correlation**
  - Sensing for one TV band
  - Sensing procedure for TV signals
  - Sensing for multiple TV channel band
- **Selection of frequency components: emphasizing near Parts with abrupt changes**
- **ATSC cyclostationary sensing technique**

## Signal specific

- ATSC Sequence correlation sensing
  - ATSC signature
  - Pilot recovery
  - Single ATSC data field
  - Multiple ATSC data fields
  - Sync segment
- **ATSC FFT-based Pilot sensing (Philips)**
- ATSC Pilot sensing technique using high order statistics
- ATSC PLL-based Pilot sensing technique
  - Dual FPLL pilot sensing
- ATSC Pilot covariance sensing technique
  - Covariance based sensing
- Higher order statistics based pilot detection

# DTV Broadcast Incumbent Sensing ATSC FFT-based Pilot Sensing Technique (Philips)

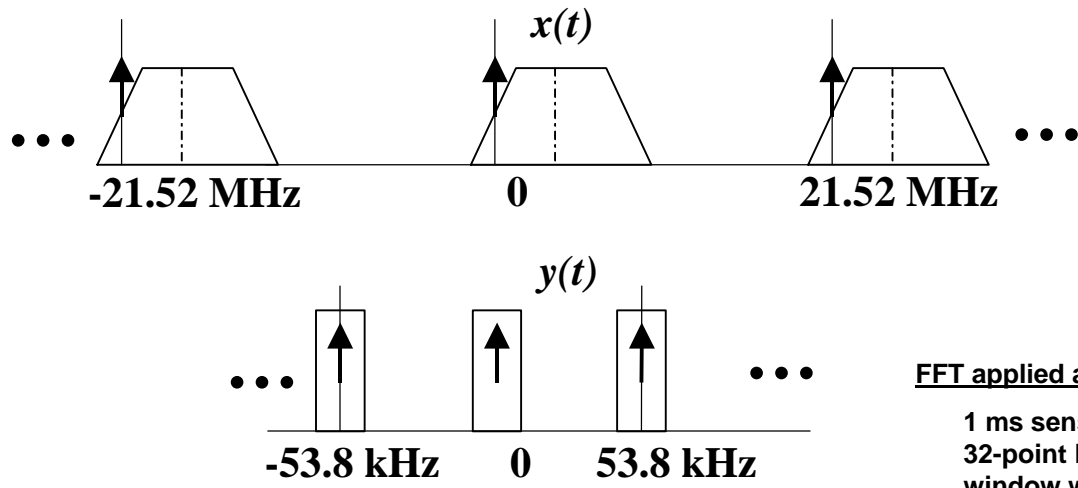

FFT applied around the pilot carrier  
 1 ms sensing window will allow a 32-point FFT while a 5 ms window will allow a 256-point FFT

Required SNR for DTV signal detection

Method	5 ms	10 ms	30 ms	50 ms
Pilot-Energy	-18 dB	-20.5 dB	-23.5 dB	-24.5 dB
Pilot-Location (NT=2)	---	-18.5 dB	-22.0 dB	-24.0 dB

# DTV Broadcast Incumbent Sensing

## Sensing techniques performance comparison

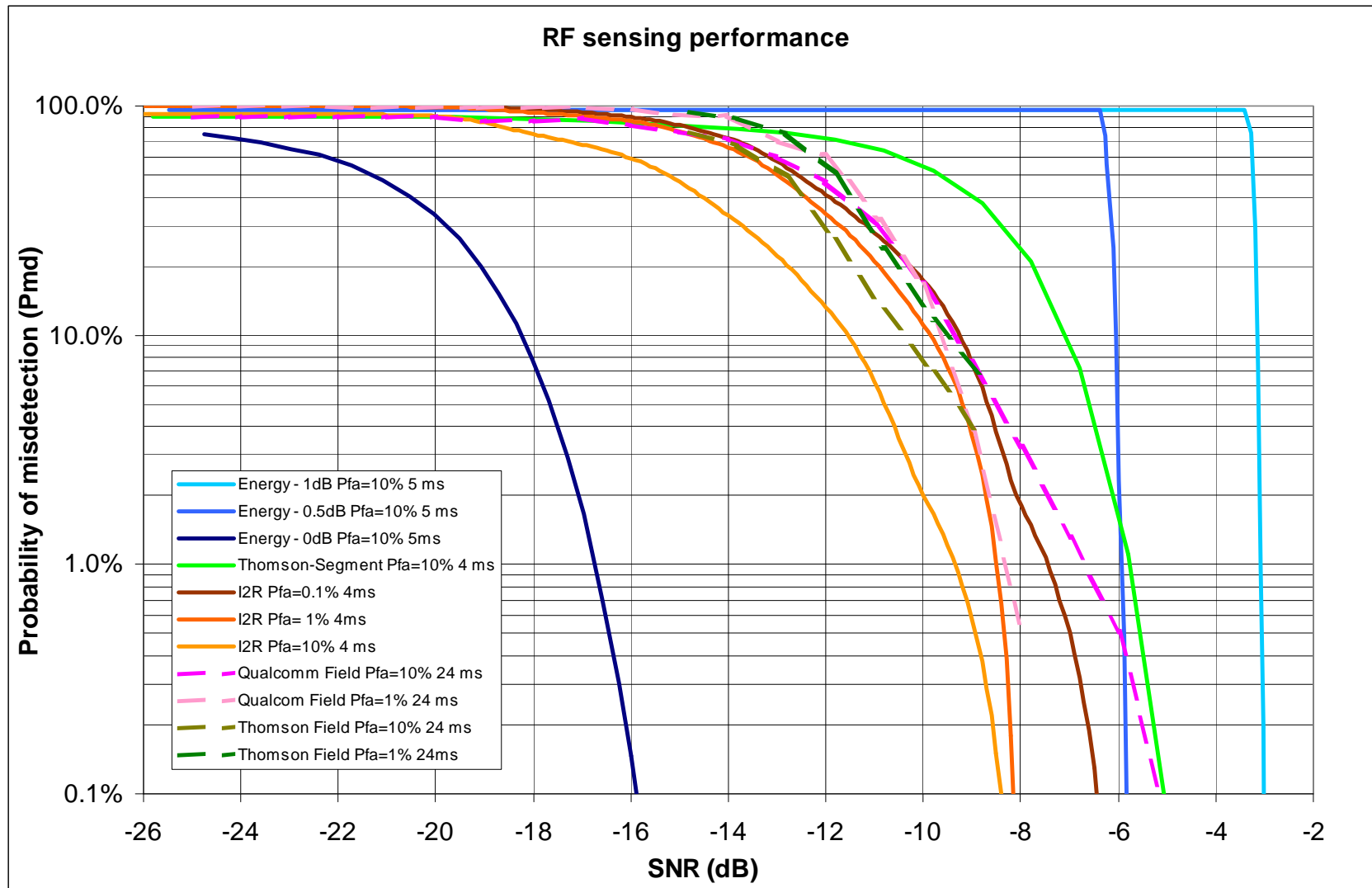



# Outline

1. **The IEEE 802.22 WRAN Standard**
2. **Coexistence among communication systems in TV White Space**
  - a) Protection of TV broadcasting
  - b) Protection of Part 74 wireless microphones**
  - c) 802.22.1 wireless microphone beacon
  - d) Quiet periods for sensing
  - e) Self-coexistence among WRAN systems
3. **Further observations**
  - a) DTV coverage protection
  - b) RF mask

# WRAN coverage and co-channel operation with wireless microphones

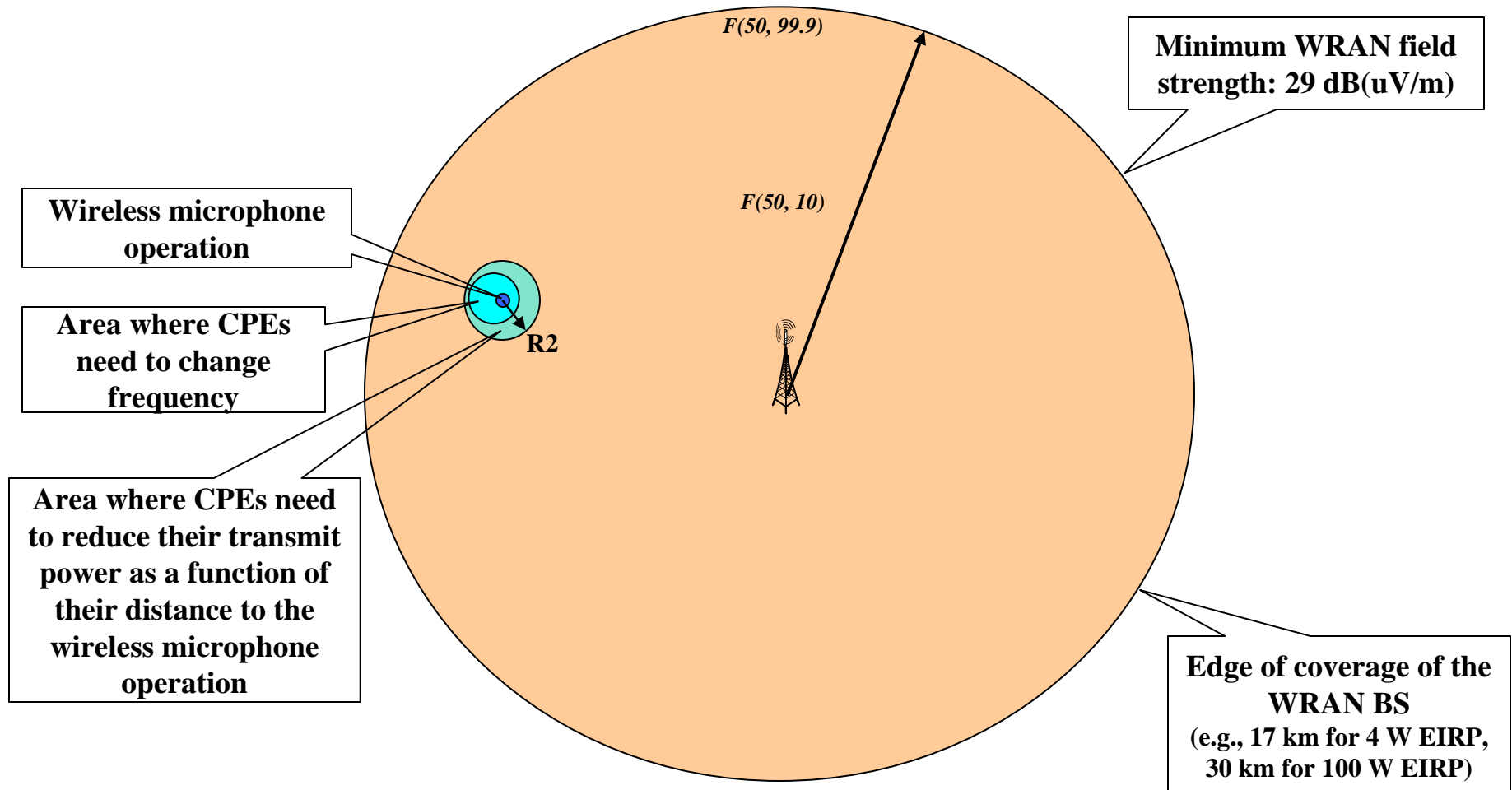

# Wireless microphone sensing techniques studied by 802.22

- **Signal specific**
  - **Wireless microphone covariance sensing technique**
    - Covariance based sensing
      - Covariance absolute value detection
      - Covariance Frobenius norm detection
- **Spectral correlation sensing technique**
  - **Sensing for one TV band**
    - Sensing Procedure for wireless microphone signals

# Outline

1. **The IEEE 802.22 WRAN Standard**
2. **Coexistence among communication systems in TV White Space**
  - a) Protection of TV broadcasting
  - b) Protection of Part 74 wireless microphones
  - c) 802.22.1 wireless microphone beacon**
  - d) Quiet periods for sensing
  - e) Self-coexistence among WRAN systems
3. **Further observations**
  - a) DTV coverage protection
  - b) RF mask

# 802.22.1 Beacon Design

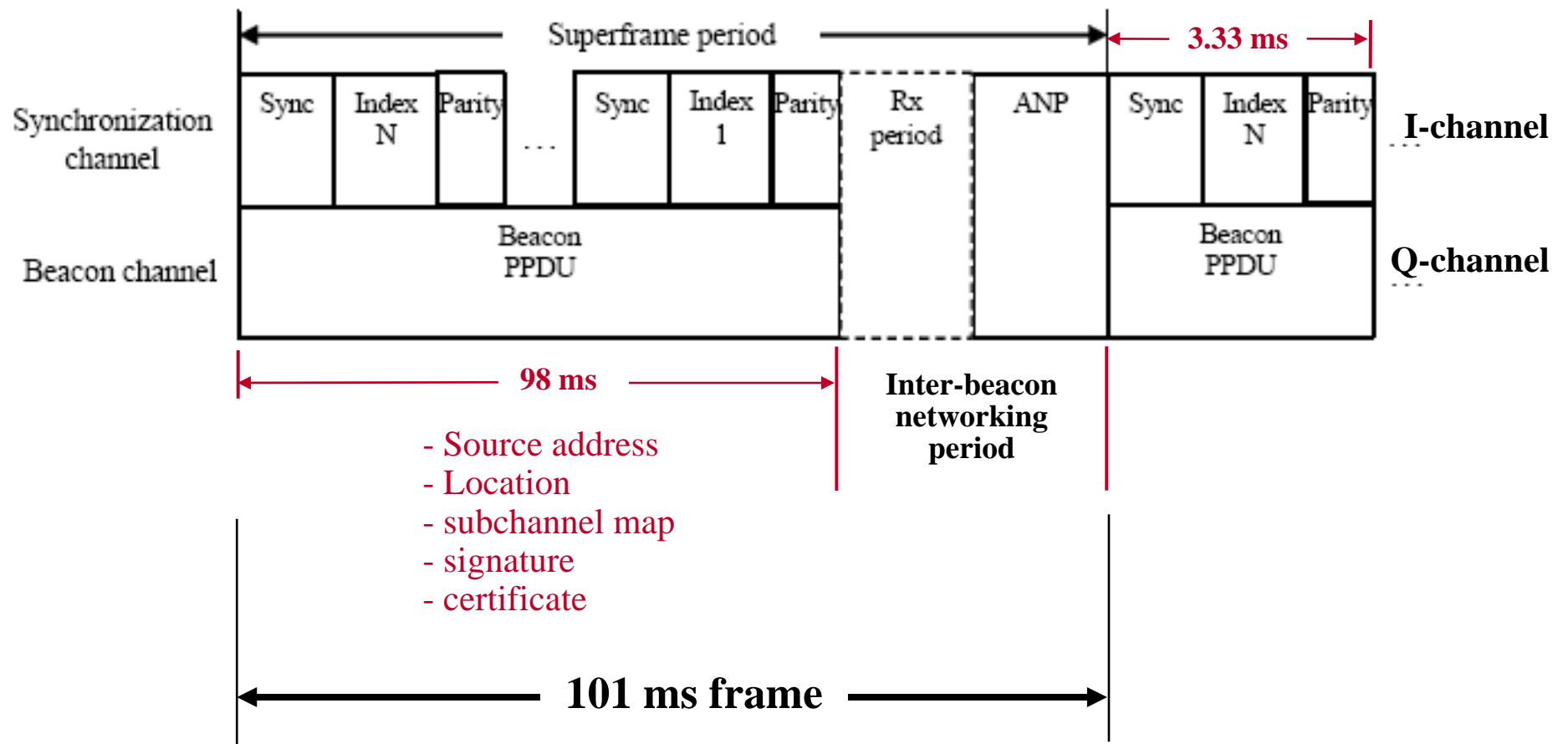

# 802.22.1 Beacon Design

Octets: 1	6	6	1	1	2	5	44	2	31	2
Parameter 1	Source Address	<b>Location</b>	Parameter 2	Parameter 3	CRC 1	Map	<b>Signature</b>	CRC 2	<b>Certificate</b>	CRC 3
MSF 1						MSF 2		MSF 3		

**PPDU (101 octets)**

# Detection of the 802.22.1 beacon

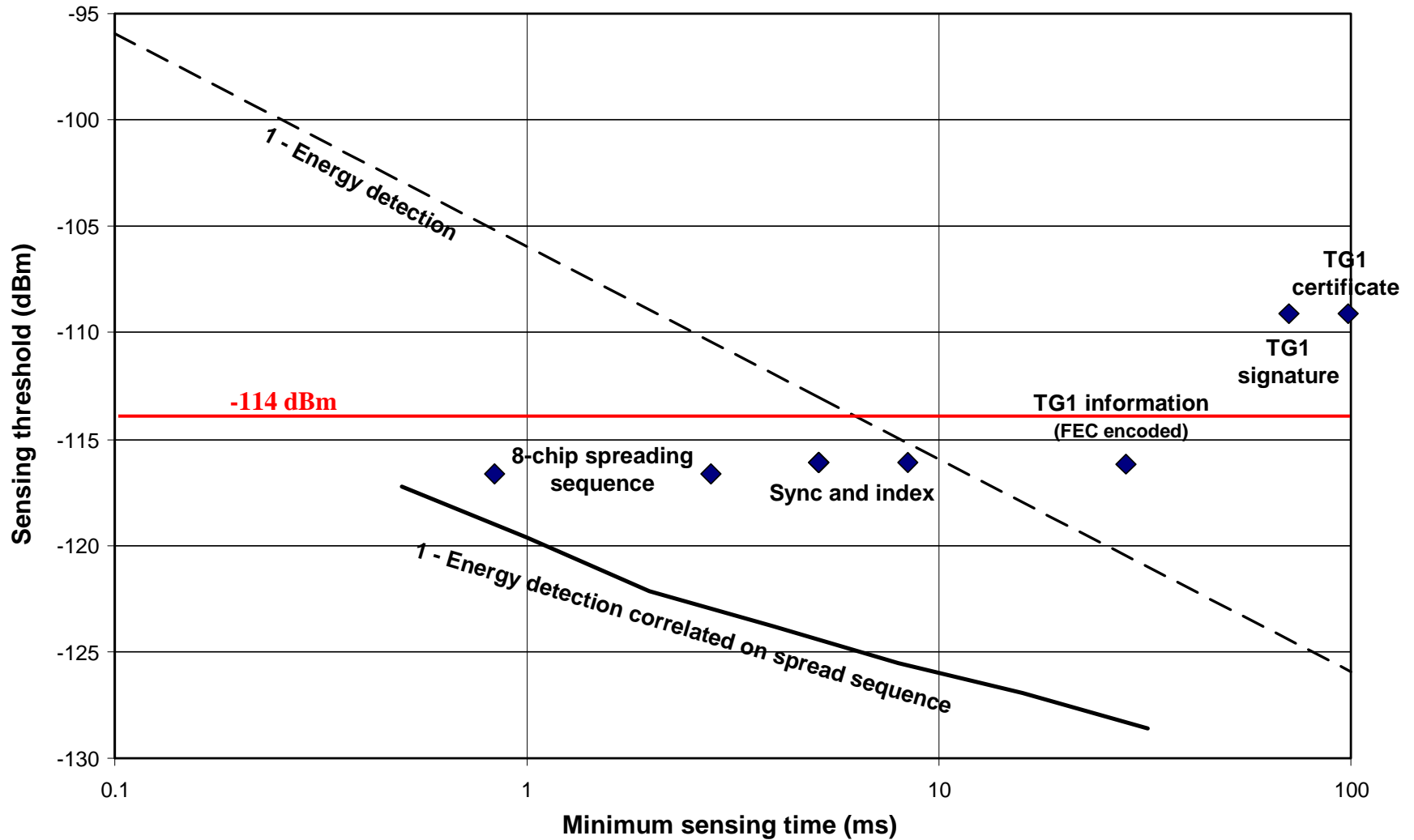

# Outline

1. **The IEEE 802.22 WRAN Standard**
2. **Coexistence among communication systems in TV White Space**
  - a) Protection of TV broadcasting
  - b) Protection of Part 74 wireless microphones
  - c) 802.22.1 wireless microphone beacon
  - d) Quiet periods for sensing**
  - e) Self-coexistence among WRAN systems
3. **Further observations**
  - a) DTV coverage protection
  - b) RF mask



# 802.22 Frame Structure

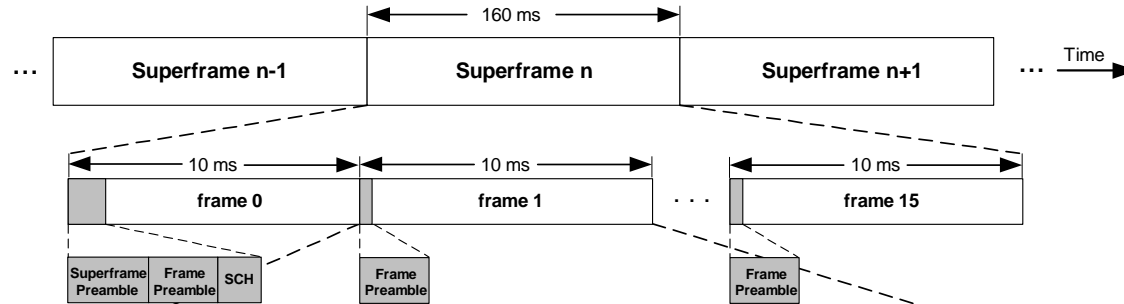

**Superframe  
= 160 ms**

**Frame  
= 10 ms**

**Superframe  
= 16 frames**

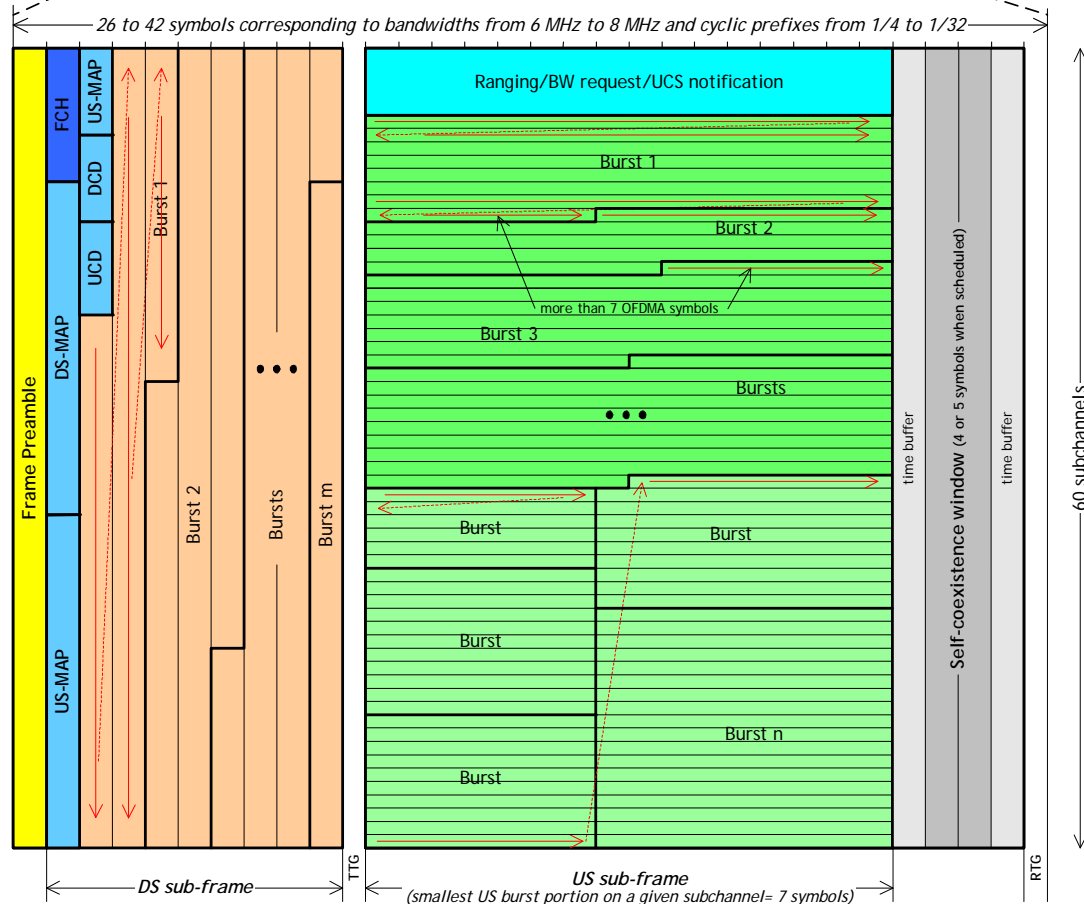

# 802.22 Frame Structure

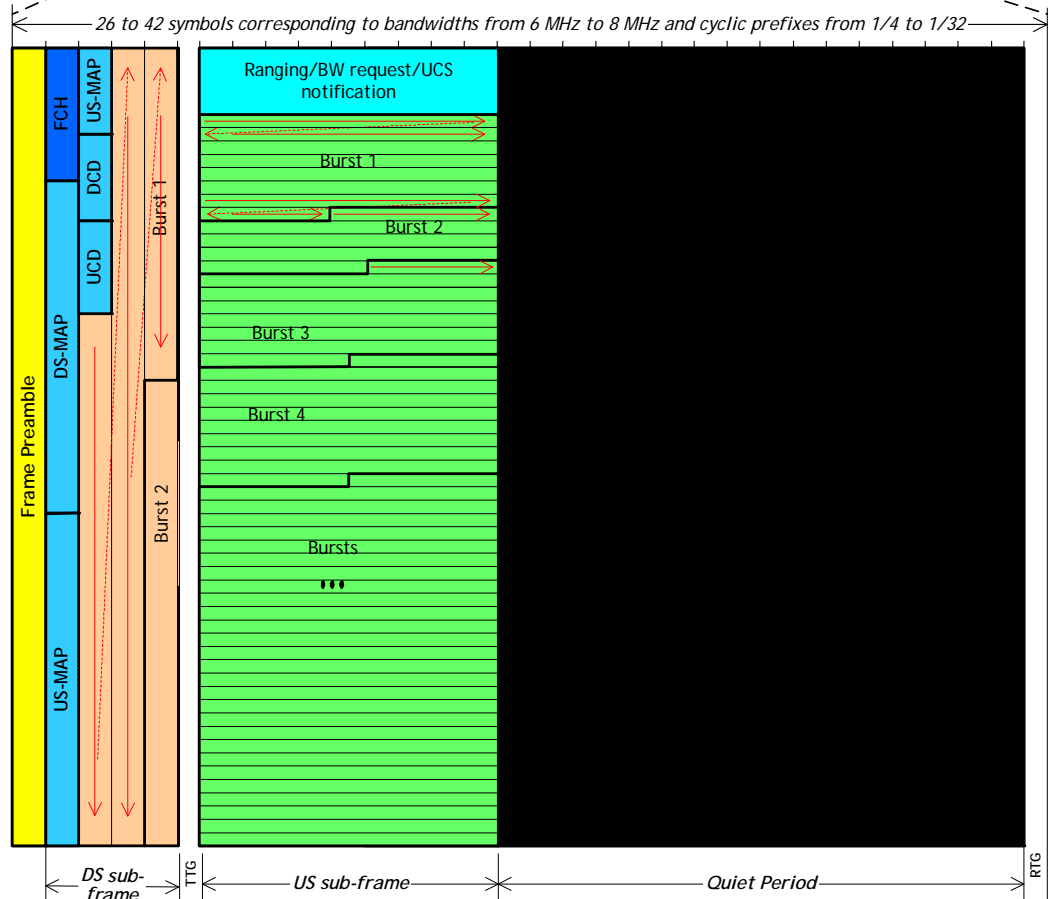
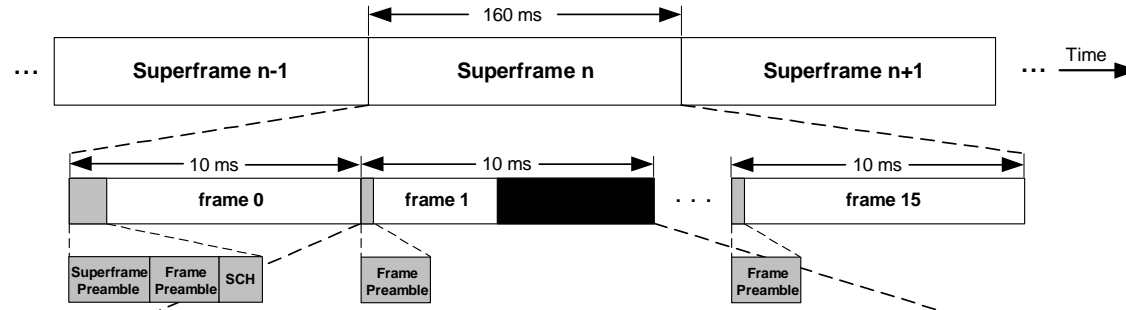

**Superframe  
= 160 ms**

**Frame  
= 10 ms**

**Superframe  
= 16 frames**

**Frame quiet  
period: 5.1 ms**

# 802.22 Superframe Structure

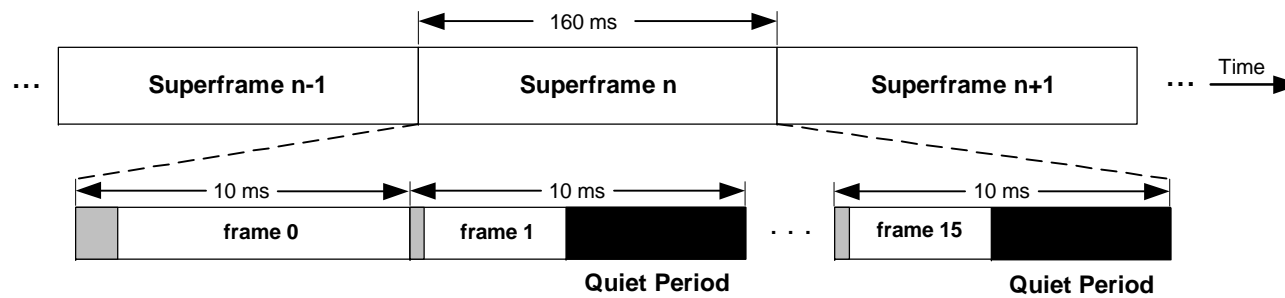

**Multi-frame  
quiet periods**

# 802.22 Superframe Structure

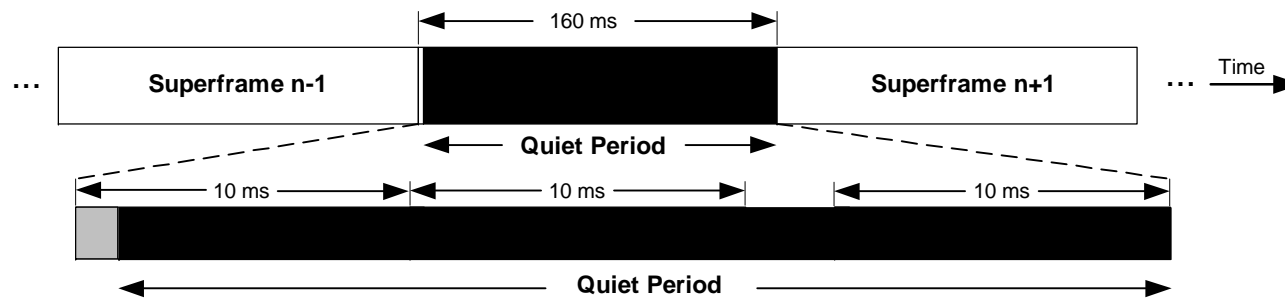

**Superframe  
quiet period:  
up to 158 ms**

# Outline

1. **The IEEE 802.22 WRAN Standard**
2. **Coexistence among communication systems in TV White Space**
  - a) Protection of TV broadcasting
  - b) Protection of Part 74 wireless microphones
  - c) 802.22.1 wireless microphone beacon
  - d) Quiet periods for sensing
  - e) Self-coexistence among WRAN systems**
3. **Further observations**
  - a) DTV coverage protection
  - b) RF mask

# WRAN Self-coexistence considerations

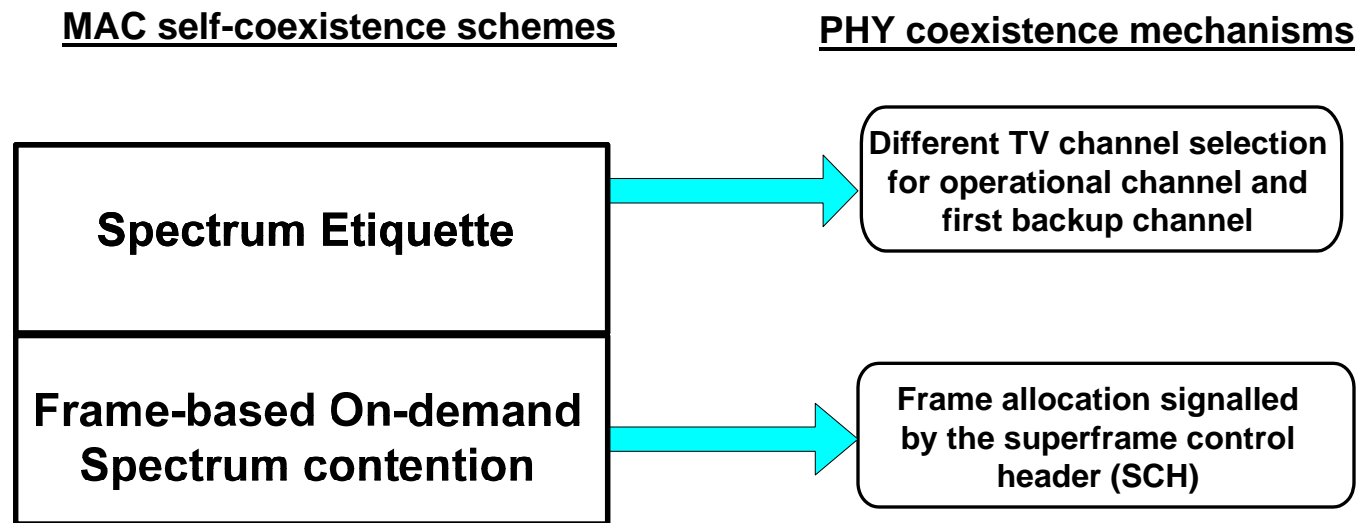

# Frame-based Spectrum Contention

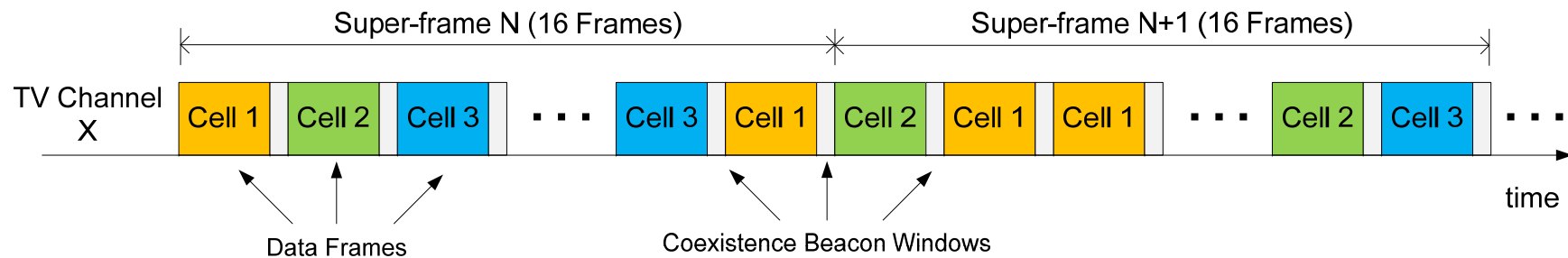

- **Multiple WRAN cells share a TV channel on a dynamic (on-demand) basis.**
- **Each WRAN cell has an exclusive access to a set of data frames within a super-frame.**
- **WRAN cells exchange contention messages, containing random contention numbers, to determine their rights of data frame access.**
  - The winner of a contention (i.e. comparison of contention numbers) will occupy a target data frame.
- **Spectrum contention messages are exchanged in the synchronized coexistence beaconing windows or through the backhaul.**

# Coexistence Beacons for Inter-WRAN Communications

- **Inter-cell communication mechanism to keep BSs aware of the other nearby WRAN cell operation:**
  - Coexistence beacon
    - Transmitted during the self-coexistence windows at the end of some frames by the BS and/or some designated CPEs
    - Monitored by BSs and other CPEs from same and different cells on same channel or different channel for future channel switching
    - Signals IP address of BS and CPE every 15 min. as asked by R&O

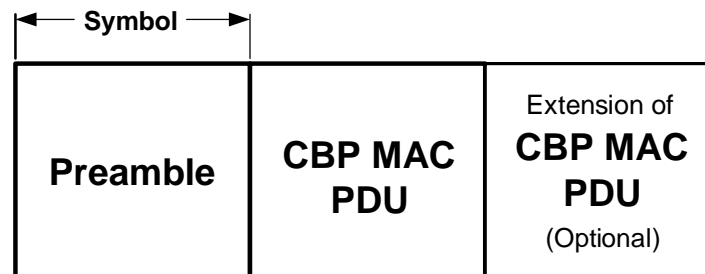

## Coexistence Beacon Protocol (CBP) burst



# Inter-WRAN Communications Scenarios

(Require Neighbor-cell CPEs to exist)

- The “face-to-face CPEs” case:
- The “back-to-back CPEs” case:

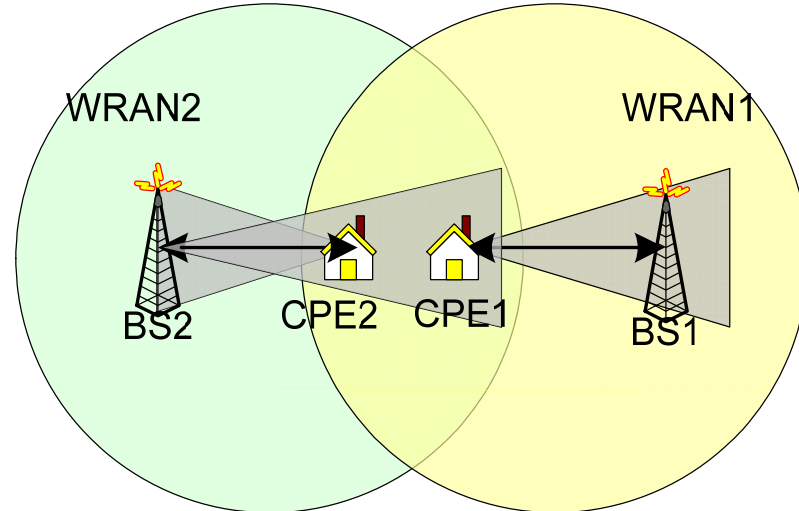
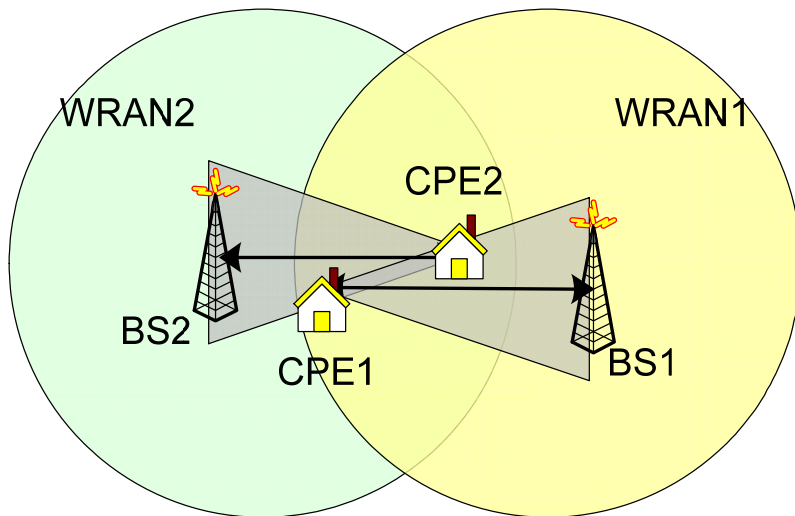

# Outline

1. **The IEEE 802.22 WRAN Standard**
2. **Coexistence among communication systems in TV White Space**
  - a) Protection of TV broadcasting
  - b) Protection of Part 74 wireless microphones
  - c) 802.22.1 wireless microphone beacon
  - d) Quiet periods for sensing
  - e) Self-coexistence among WRAN systems
3. **Further observations**
  - a) DTV coverage protection
  - b) RF mask

# DTV Coverage: Athen, GA

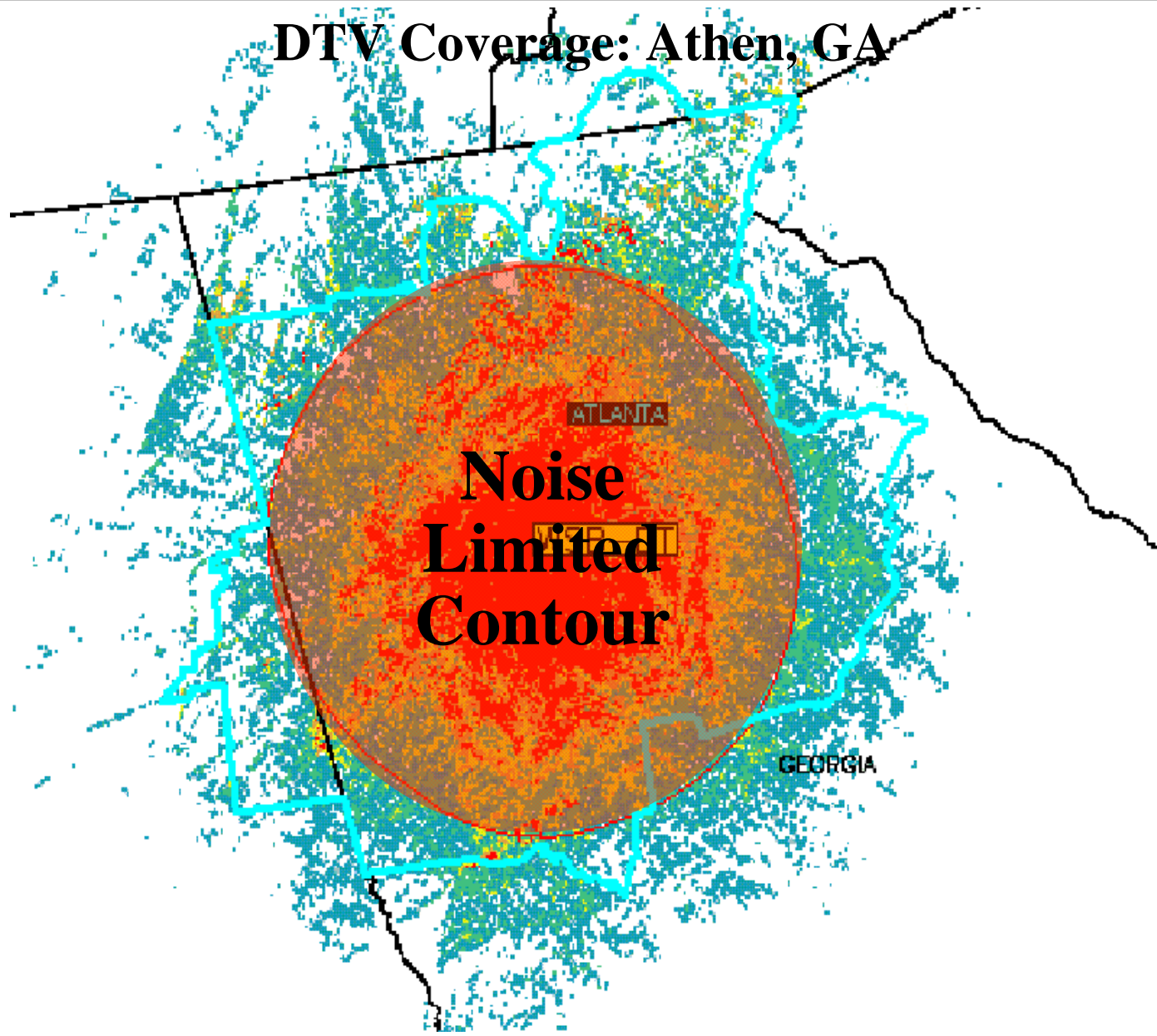

# 802.22 RF Mask

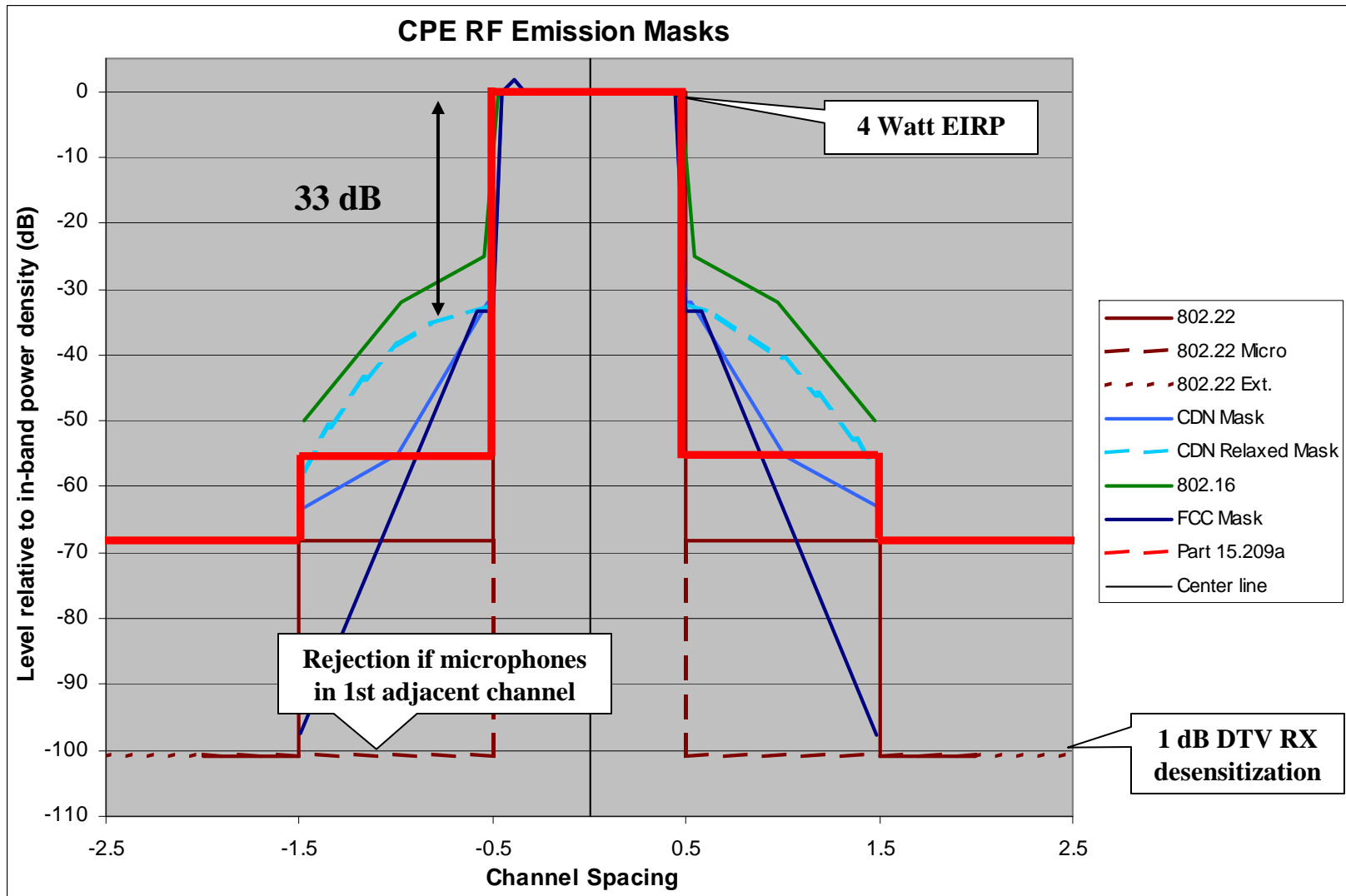

## References

1. *IEEE P802.22™/ DRAFTv1.0 Draft Standard for Wireless Regional Area Networks Part 22: Cognitive Wireless RAN Medium Access Control (MAC) and Physical Layer (PHY) specifications: Policies and procedures for operation in the TV Bands, April 2008*
2. FCC R&O 08-260

# IEEE SCC41 Standards for Dynamic Spectrum Access Networks

Date: **Mar 10 2009**

## Authors:

Name	Company	Address	Phone	email
Hiroshi Harada (SCC41 Acting Chair)	NICT	3-4 Hikarino-oka, Yokosuka, 239-0847, Japan	+81 46 847 5074	<a href="mailto:harada@nict.go.jp">harada@nict.go.jp</a>
Paul Houzé (P1900.4 chair)	France Telecom	38-40 rue du general Leclerc 92794 Issy Les Moulineaux, France	+33 1 45 29 44 06	<a href="mailto:paul.houze@orange-ftgroup.com">paul.houze@orange-ftgroup.com</a>
Lynn Grande(P1900.5 chair)	General Dynamics C4 systems			
Klaus Moessner (P1900.6 chair)	Univ. of Surrey			

**Notice:** This document has been prepared to assist IEEE ECSG on TV White Space. It is offered as a basis for discussion and is not binding on the contributing individual(s) or organization(s). The material in this document is subject to change in form and content after further study. The contributor(s) reserve(s) the right to add, amend or withdraw material contained herein.

**Release:** The contributor grants a free, irrevocable license to the IEEE to incorporate material contained in this contribution, and any modifications thereof, in the creation of an IEEE Standards publication; to copyright in the IEEE's name any IEEE Standards publication even though it may include portions of this contribution; and at the IEEE's sole discretion to permit others to reproduce in whole or in part the resulting IEEE Standards publication. The contributor also acknowledges and accepts that this contribution may be made public by IEEE 802.

**Patent Policy and Procedures:** The contributor is familiar with the IEEE 802 Patent Policy and Procedures <<http://iee802.org/guides/bylaws/sb-bylaws.pdf>>, including the statement "IEEE standards may include the known use of patent(s), including patent applications, provided the IEEE receives assurance from the patent holder or applicant with respect to patents essential for compliance with both mandatory and optional portions of the standard." Early disclosure to the TAG of patent information that might be relevant to the standard is essential to reduce the possibility for delays in the development process and increase the likelihood that the draft publication will be approved for publication. Please notify the Chair <[matthew.sherman@baesystems.com](mailto:matthew.sherman@baesystems.com)> as early as possible, in written or electronic form, if patented technology (or technology under patent application) might be incorporated into a draft standard being developed within the IEEE. If you have questions, contact the IEEE Patent Committee Administrator at <[patcom@ieee.org](mailto:patcom@ieee.org)>.

# IEEE SCC41 Standards for Dynamic Spectrum Access Networks

Hiroshi Harada and Paul Houzé

---

# IEEE Standards Coordinating Committee 41

## Dynamic Spectrum Access Networks

### Scope

This Standards Coordinating Committee will develop standards related to *dynamic spectrum access networks*. The focus is on improved use of spectrum. New techniques and methods of dynamic spectrum access require managing interference, coordination of wireless technologies and include network management and information sharing.

### Role

- ❑ Catalyst for stakeholders to come together to address the DSA market
- ❑ Driver of consensus on technical approaches
- ❑ World-class standards-making venue
- ❑ Contributor to DSA regulations and policies



---

# SCC41 Working Groups

- ❑ **IEEE 1900.1:** Standard Definitions and Concepts for Spectrum Management and Advanced Radio System Technologies
- ❑ **IEEE 1900.2:** Recommended Practice for Interference and Coexistence Analysis
- ❑ **IEEE 1900.3:** Standard for Assessing the Spectrum Access Behavior of Radio Systems Employing Dynamic Spectrum Access Methods
- ❑ **IEEE 1900.4:** Standard for Architectural building blocks enabling network-device distributed decision making for optimized radio resource usage in heterogeneous wireless access networks
- ❑ **IEEE 1900.5:** Standard on Policy Language and Policy Architectures for Managing Cognitive Radio for Dynamic Spectrum Access Applications
- ❑ **IEEE 1900.6:** Standard on interfaces and data structures for exchanging spectrum sensing information for dynamic spectrum access systems

# Status of SCC41 Working Groups

	1900.1	1900.2	1900.3	1900.4	1900.5	1900.6
PAR Approved	3/04/05	03/20/05	12/05/07	12/06/06	03/28/08	9/26/08
Initial Ballot - Open	9/07/07	07/02/07	Pending Withdrawal	9/08/08		
Initial Ballot – Close	10/07/07	08/03/07		10/08/08		
1 <sup>st</sup> Recirc – Close	4/17/08	10/24/07		10/26/08		
2nd Recirc - Close		01/01/08		11/22/08		
RevCom Approval	4/10/08	1/08/08		1/19/09		
SASB Approval	6/12/08	3/28/08		1/29/09		
Published	9/26/08	7/29/08		2/27/09		

# 1900.4 Standard

Architectural Building Blocks Enabling Network-Device  
Distributed Decision Making for Optimized Radio Resource  
Usage in Heterogeneous Wireless Access Networks

Chair	Paul Houzé	<a href="mailto:paul.houze@orange-ftgroup.com">paul.houze@orange-ftgroup.com</a>
Vice Chair	Hiroshi Harada	<a href="mailto:harada@nict.go.jp">harada@nict.go.jp</a>
Vice Chair	Ralph Martinez	<a href="mailto:ralph.martinez@baesystems.com">ralph.martinez@baesystems.com</a>

# 1900.4 Standard Scope

- To address radio resource management, **reconfiguration management** in **composite wireless network**
  - Multiple Radio Access Technologies
  - IEEE 802.xx, Cellular 2<sup>nd</sup>, 3<sup>rd</sup> generation
- In **Dynamic Spectrum Access** context
  - also addresses optimization of resources in fixed spectrum allocation
- **Policy-based management**: Network-device distributed decision making
  - Event-Condition-Action Policies
  - Policies are sent by network to terminals via a "radio enabler"
- **1900.4 standard was published** on February 27th 2009.  
<http://grouper.ieee.org/groups/scc41/4/documents.htm>
- WS Study Group documents:09-0031; 09-0022

# 1900.4 Use Cases (2/9)

Spectrum

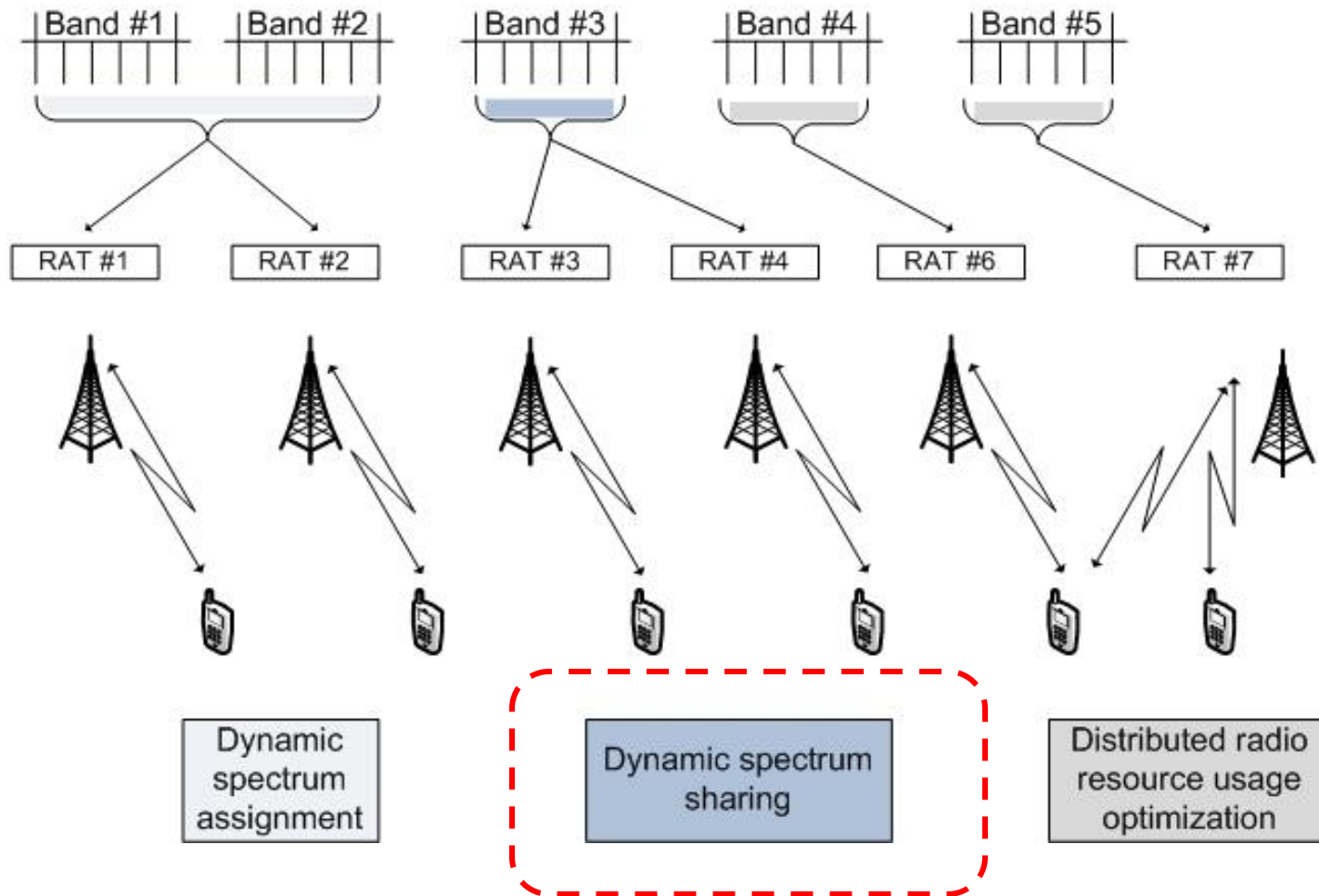

# Architecture

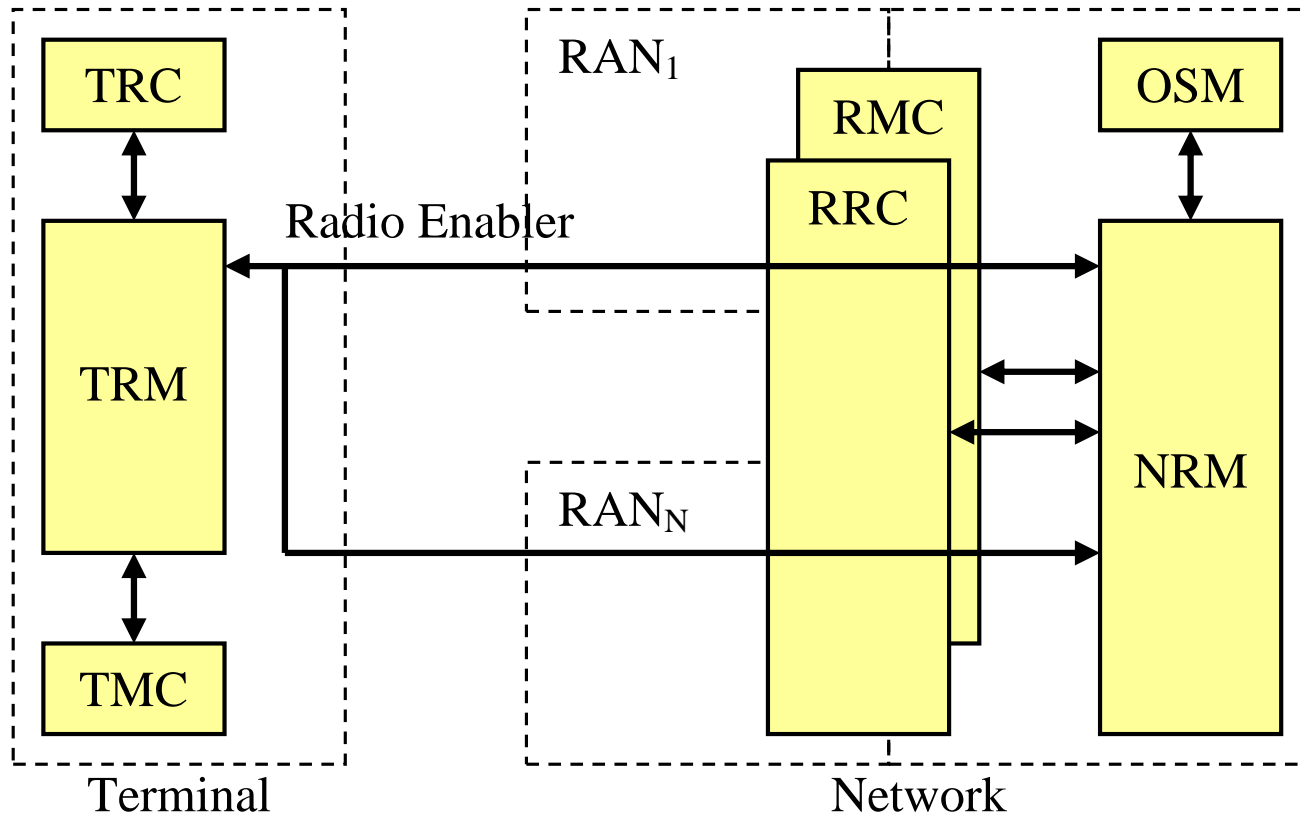

TRM – Terminal Reconfiguration Manager  
 TRC – Terminal Reconfiguration Controller  
 TMC – Terminal Measurement Collector  
 OSM – Operator Spectrum Manager

NRM – Network Reconfiguration Manager  
 RRC – RAN Reconfiguration Controller  
 RMC – RAN Measurement Collector  
 RAN – Radio Access Network configuration

## □ Service Access points

- **Transport SAP** provides transport service for message exchange between P1900.4 entities.
  - Typically used to exchange radio resource selection policies and context information between NRM and TRM.
- **Reconfiguration and Measurement SAP** provides reconfiguration and measurement services for managing RANs and Terminals.
- **Management SAP** provides management service for managing P1900.4 entities

## □ Information Model

- Type, nature, structure of the information to be exchanged via the defined interfaces
- Uses an object-oriented approach to describe policies, terminal classes, network classes.

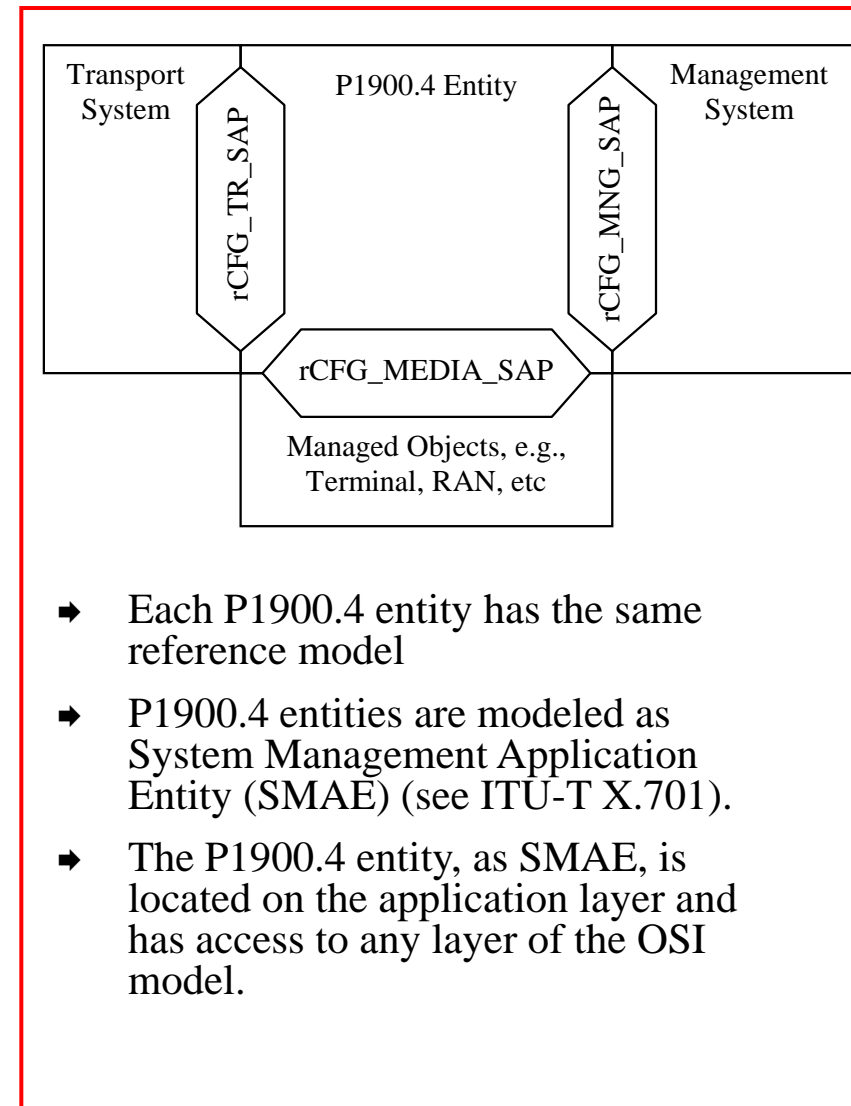

---

# Way forward

- SCC41 approved the submission of two Project Authorization Requests:
  - 1900.4.1: "interfaces and protocols enabling distributed decision making for optimized radio resource usage in heterogeneous wireless networks"
  - 1900.4.a: "IEEE Standard for Architectural building blocks enabling network-device distributed decision making for optimized radio resource usage in heterogeneous wireless access networks – Amendment: Architecture and interfaces for dynamic spectrum access networks in white space frequency bands".
- The PARs are currently under review by IEEE-SA. The related work will start at next SCC41 meeting in London 6-9 April 2009.
- 1900.4 ready for starting specifications of interfaces and protocols to address white spaces
  - Protocols towards external entities (database)
  - Transport, reconfiguration, management from higher layers.



# 1900.5 Standard

Standard on Policy Language and Policy Architectures for  
Managing Cognitive Radio for Dynamic Spectrum Access  
Applications

Chair                      Lynn Grande                      [lynngrande@ieee.org](mailto:lynngrande@ieee.org)

Vice Chair                James Hoffmeyer                [jhoffmeyer@ieee.org](mailto:jhoffmeyer@ieee.org)

---

# Scope and purpose

- Scope: This standard defines a set of policy languages, and their relation to policy architectures, for managing the functionality and behaviour of cognitive radios for dynamic spectrum access applications in a vendor-independent fashion.
- Purpose: The purpose of this standard is to define a policy language (or a set of policy languages or dialects), and their relation to policy architectures, for specifying interoperable, vendor-independent control of Cognitive Radio functionality and behavior for Dynamic Spectrum Access resources and services. This standard will also define policy language, architecture, and their relation with each other with respect to the needs of at least the following constituencies: the regulator, the operator, and the network equipment manufacturer.

From Project Authorization Request (PAR) available at:

<https://development.standards.ieee.org/get-file/P1900.5.pdf?t=21212900024>

---

# Progress

- ❑ A standard outline and workplan are almost finalized.
- ❑ There will be an outreach activity conducted to get input from the user community on use cases and policy language input from academia and research institutions.
- ❑ Policies and Procedures were updated and voted.
- ❑ 2 – 3 F2F meetings a year, 1-2 telecons a month.
- ❑ Three ad-hoc subgroups identified to focus work:
  - Policy Architecture
  - Policy Language
  - Use Case Analysis
- ❑ Goal is to define requirements by end of May 2009. Requirements in progress. Each ad-hoc group meets regularly to work on their area of the draft specification.

# 1900.6 Standard

Spectrum Sensing Interfaces and Data Structures for Dynamic  
Spectrum Access and other Advanced Radio Communication  
Systems

Chair

Klaus Moessner

[k.moessner@surrey.ac.uk](mailto:k.moessner@surrey.ac.uk)

---

# Scope and purpose

## □ Scope

- This standard defines the information exchange between spectrum sensors and their clients in radio communication systems.
- The logical interface and supporting data structures used for information exchange are defined abstractly without constraining the sensing technology, client design, or data link between sensor and client.

## □ Purpose

- The purpose of this standard is to make development and evolution of spectrum sensors independent of the development and evolution of other system functions.

# Interfaces in P1900.6

## □ Standardization topics

The standard will provide a formal definition of data structures and interfaces for exchange of sensing related information between sensors and users of sensing information (client/cognitive engines)

## □ Current status

- Three SEDs on Objectives, Use Cases and State of the Art has been edited
- SEDs set the system boundaries and link to the currently conceivable deployment scenarios
- To develop the requirements, the use cases will be analysed together with objectives and the current state of the art in sensing technologies.

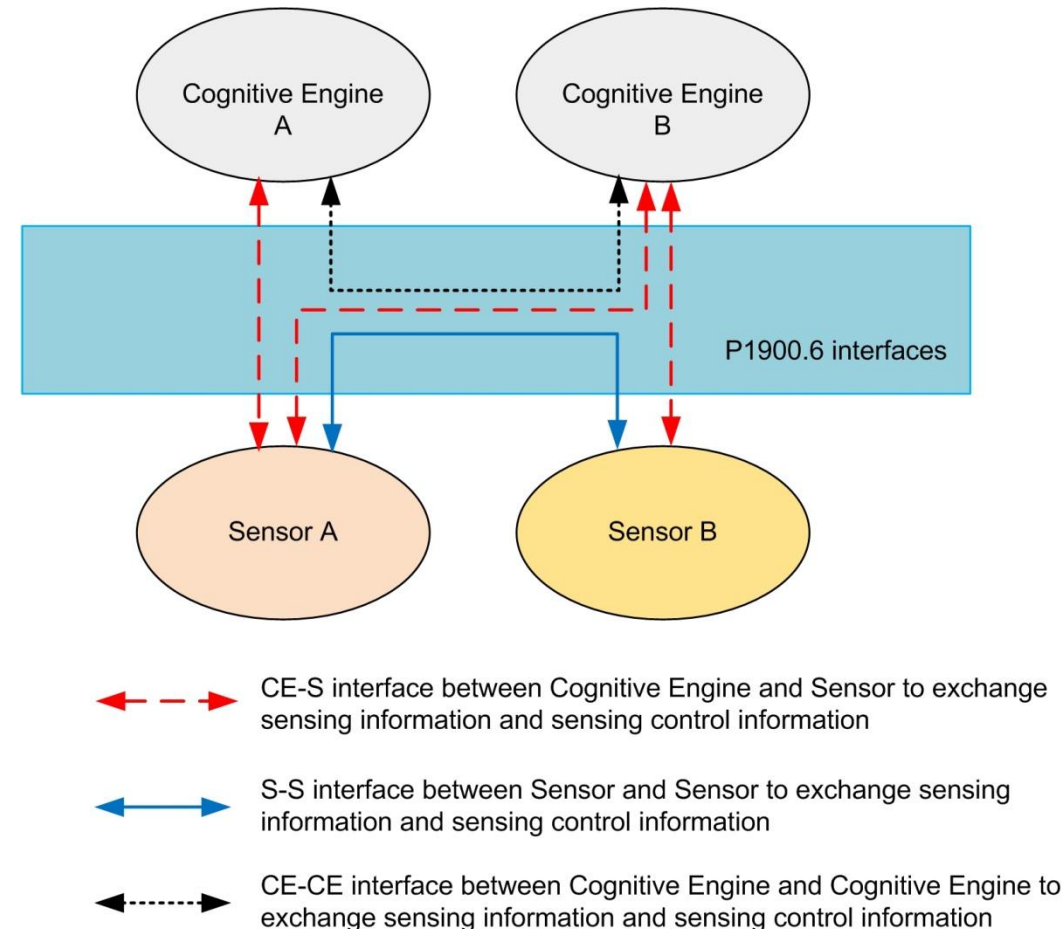

# For more information

## □ Meeting

### 2009 Plenary meeting

- April 2009, Kings College, UK
- September 2009, IEEE HQ, Piscataway, NJ

## □ SCC41 Website

<http://www.scc41.org>

---

# Appendix 1: Definitions of Dynamic Spectrum Access and Cognitive Radio

According to the P1900.1 Standard : -

- ❑ Dynamic Spectrum Access is the real-time adjustment of Spectrum Utilization in response to changing circumstances and objectives.
  
- ❑ Cognitive Radio is a type of Radio in which communication systems are aware of their environment and internal state and can make decisions about their radio operating behavior based on that information and predefined objectives.



# Work in the ITU: Focus on how 802 can best leverage Work in ITU for TV Whitespace

Date: 2009-02-16

## Author:

Name	Affiliations	Address	Phone	email
Rashid A. Saeed	Telekom Malaysia R&D	Lingharan Teknograd Timur, 63000 Cyberjaya Selangor Malaysia	60- 173023065	drashid.saeed@tmrnd.com.my

# ITU-R Structure

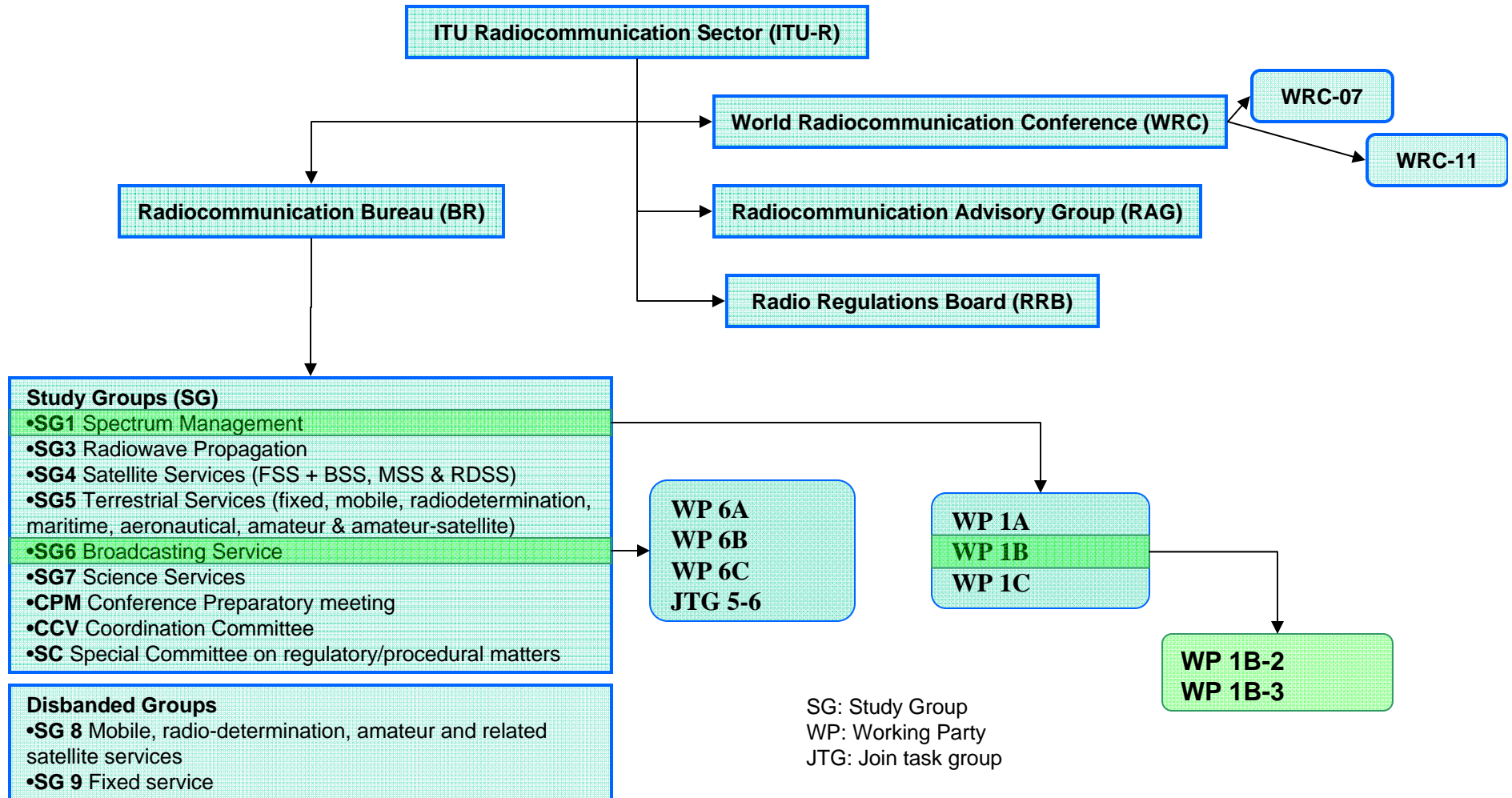

## Study Group 1: Spectrum management

- Scope
  - Spectrum management principles and techniques, general principles of sharing, spectrum monitoring, long-term strategies for spectrum utilization, economic approaches to national spectrum management, automated techniques and assistance to developing countries in cooperation with the Telecommunication Development Sector.
- Mandate
  - UWB, SRD, compatibility with active and passive services and RAS,
  - Measurements of Radio noise, monitoring receivers/stations, DF ...
  - International spectrum regulatory framework
  - National spectrum management aspects (regulatory, economic, strategic, planning, ...)
- **WP 1A - Spectrum engineering techniques**
- **WP 1B - Methodologies and economic strategies**
- **WP 1C - Spectrum monitoring**
- **(TG 1/9 : Compatibility between different passive and active services)**

# Working Party 1B

- **WG 1B-1**
  - Short-range devices – Recommendation ITU-R SM.1538 (Technical and operating parameters and spectrum requirements for short-range radio communication devices)
- **WG 1B-2**
  - WRC-11 Agenda item 1.19 – Software-defined radio and cognitive radio
- **WG 1B-3**
  - WRC-11 Agenda item 1.2 – Resolution 951 (Rev.WRC-07)
- **Ad hoc Group**
  - Other WP 1B issues

## Study Group 6: Broadcasting Service

- Scope
  - Programme production, Programme assembly, Delivery, Reception quality (incl. vision, sound, multimedia, data, etc.)
- Mandate
  - Protection criteria for digital TV and sound systems (RRC-06)
  - Spectrum issues at HF
  - Multimedia and data broadcasting for mobile reception
  - Large Screen Digital Imagery (LSDI)
  - Recording formats
- WP 6A - Terrestrial broadcasting delivery
- WP 6B - Broadcast Service assembly and access
- WP 6C - Programme production and quality assessment
- **JTG 5-6: - Studies on the use of the band 790-862 MHz by mobile applications and by other services**

# WRC-2007

- **WRC is world Radiocommunication conference**
  - Held every 3 to 4 years
  - Updates the ITU Radio Regulation
  - Revisions are made on the basis of an agenda established in advance
  - Study Groups, Working Parties consider technical aspects of agenda items for WRCs.
- **WRC 2007 Informal Working groups:**
  - IWG-1 Terrestrial and Space Science Services
  - IWG-2 Satellite Services and HAPS
  - IWG-3 IMT-2000 and 2.5 GHz Sharing Issues
  - IWG-4 Broadcasting and Amateur Issues
  - IWG-5 Regulatory Issues



# WRC-11 agenda items

- **Key agendas related to whitespace cognitive radio are :**
  - AI 1.2 – Resolution 951 (enhance radio regulatory framework) – (WG 1B-3)
  - AI 1.19 – Regulatory measures to enable introduction of software-defined radio and cognitive radio systems – (WG 1B-2)
  - AI 1.22 – Study of short-range devices emission on existing radio-communication services (WP-1A)
  
- **Other Related issues**
  - AI 1.3 – Allocation on safe use of UAS - (WP-5B)
  - 1.14 – new applications in the radiolocation service and review allocations or regulatory provisions for implementation of the radiolocation service in the range 30-300 MHz – (WP-5B)
  - 1.17 – sharing studies between the mobile service and other services in the band 790-862 MHz in Regions 1 and 3 – (JTG 5-6)

# WRC-11: Informal Working Groups

- **WRC-11 Informal Working Groups**
  - IWG-1 Maritime, Aeronautical and Radar Services
    - WRC-11 Agenda Items 1.3, 1.4, 1.9 1.10, 1.12, 1.14, 1.15 and 1.21
  - IWG-2 Terrestrial Services
    - WRC-11 Agenda Items 1.5, 1.8, 1.16, 1.17, 1.19, 1.20, 1.22 and 1.23
  - IWG-3 Space Services
    - WRC-11 Agenda Items 1.7, 1.11, 1.13, 1.18, 1.24 and 1.25.
  - IWG-4 Regulatory issues
    - WRC-11 Agenda Items 1.2, 1.6, 2, 4, 7 and 8.1.



## **This Question should be brought to the attention of Study Groups 1, 4, and 6.**

- **The Question on Cognitive Radio Systems was recently approved by ITU-R study groups. The specifics of the Question are that the ITU Radiocommunication Assembly: “decides that the following Question should be studied**
  - What is the ITU definition of cognitive radio systems?
  - What are the closely related radio technologies (e.g. smart radio, reconfigurable radio, policy-defined adaptive radio and their associated control mechanisms) and their functionalities that may be a part of cognitive radio systems?
  - What key technical characteristics, requirements, performance and benefits are associated with the implementation of cognitive radio systems?
  - What are the potential applications of cognitive radio systems and their impact on spectrum management?
  - What are the operational implications (including privacy and authentication) of cognitive radio systems?
  - What are the cognitive capabilities that could facilitate coexistence with existing systems in the mobile service and in other radiocommunication services, such as broadcast, mobile satellite or fixed?
  - What spectrum-sharing techniques can be used to implement cognitive radio systems to ensure coexistence with other users?
  - How can cognitive radio systems promote the efficient use of radio resources?

## Q1: ITU definition of cognitive radio systems

- **WRC-11 Agenda item 1.19, Res. 956 (WRC-07): CRSs**  
**All contributions came to the conclusion that the definition of WP5A (Annex 11 to Document 5A/168-E) should be used as a starting point.**
- **A radio system that has the capabilities;**
  - *to obtain the knowledge of radio operational environment and established policies and to monitor usage patterns and users' needs,*
  - *to dynamically and autonomously adjust its operational parameters and protocols according to this knowledge in order to achieve predefined objectives, e.g. more efficient utilisation of spectrum, and*
  - *to learn from the results of its actions in order to further improve its performance.*

## Q2: the closely related radio technologies

- Definition of SDR
  - Until now the following conclusions can be drawn from the discussion:
  - There is general agreement to use the definition from Recommendation ITU-R M.1797 as the basis.
  - The definition can be made applicable to all services by striking out the sentence “Within the mobile service” from note 3 of the definition.
- **These conclusions lead to the following definition: *Software defined radio (SDR): A radio in which the RF operating parameters including, but not limited to, frequency range, modulation type, or output power can be set or altered by software, and/or the technique by which this is achieved.***

# **ETSI Activities in TVWS**

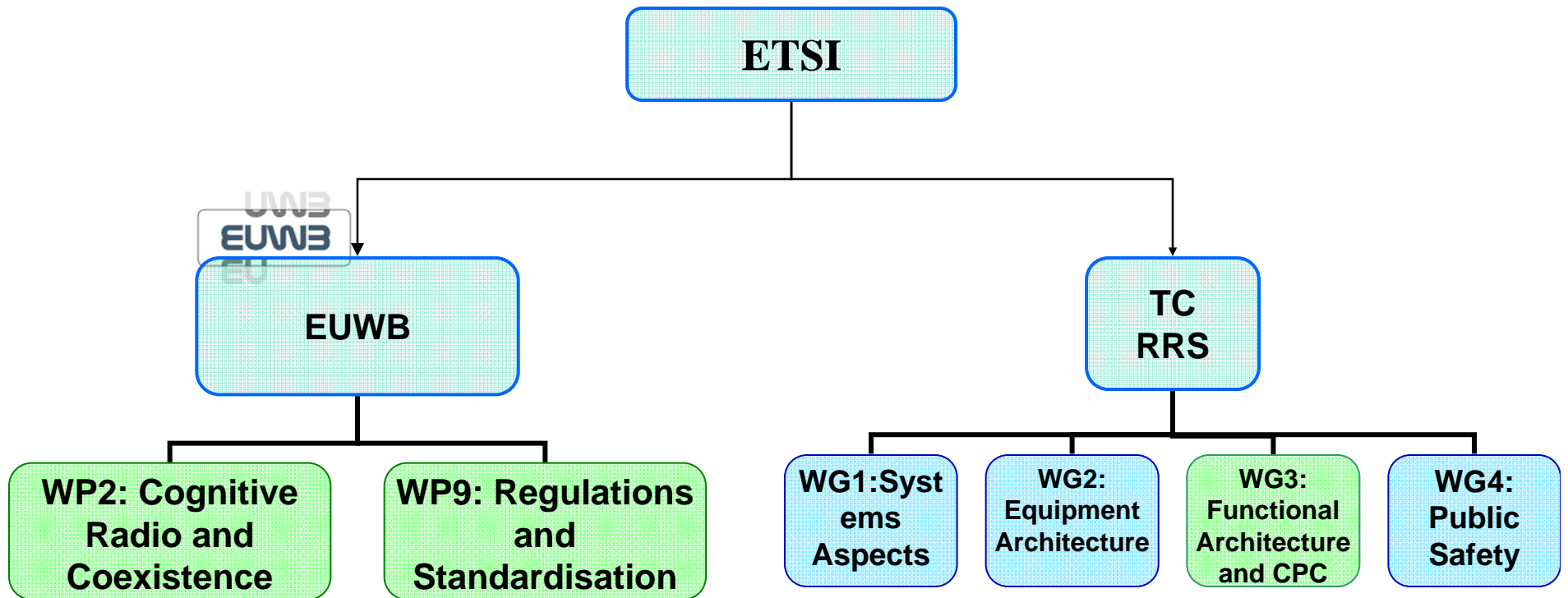

## ETSI TC RRS WG 3: FA & CPC

- TC RRS WG 3 FA & CPC shall be responsible:
- To collect and define the system functionalities for RRS.
  - These system functionalities are e.g. related to Spectrum Management and Joint Radio Resource Management across heterogeneous access technologies.
- To develop a Functional Architecture (FA) for RRS
  - including the defined system functionalities as building blocks
  - And describe key interfaces between these building blocks
- To describe and analyse the concept of a Cognitive Pilot Channel (CPC) as an enabler to support the management of the RRS
  - including on how information on e.g. available radio resources and network policies are distributed and how to take decisions based on this information.

# ETSI TC RRS WG3: FA&CPC: Functional Architecture (FA)

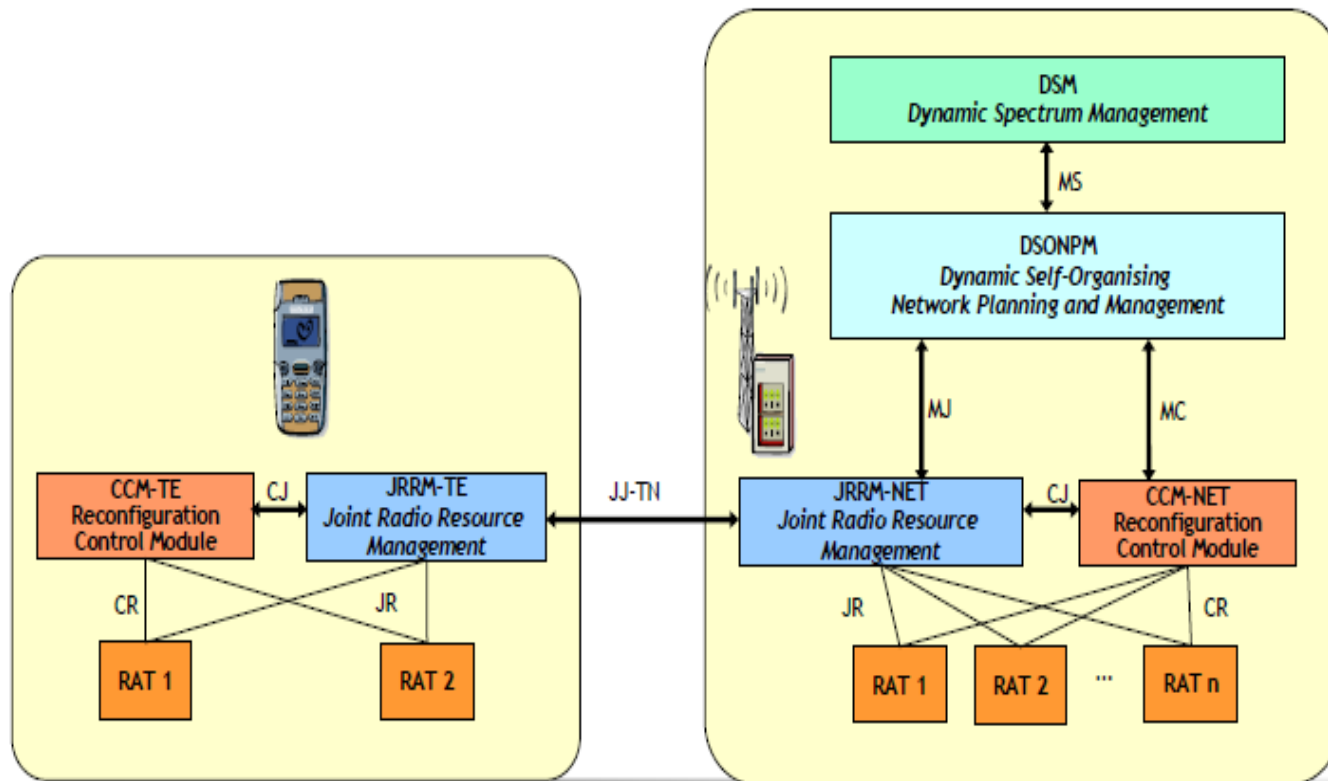

Source: Jens Gebert, Bell Labs Germany, Alcatel-Lucent “Cognitive Reconfigurable Radio Systems and Networks: ETSI RRS Standardization Activities” <http://learning.ericsson.net/mlearning2/files/workpackage5/book.doc>

# ETSI TC RRS WG3: FA&CPC: Cognitive Pilot Channel (CPC)

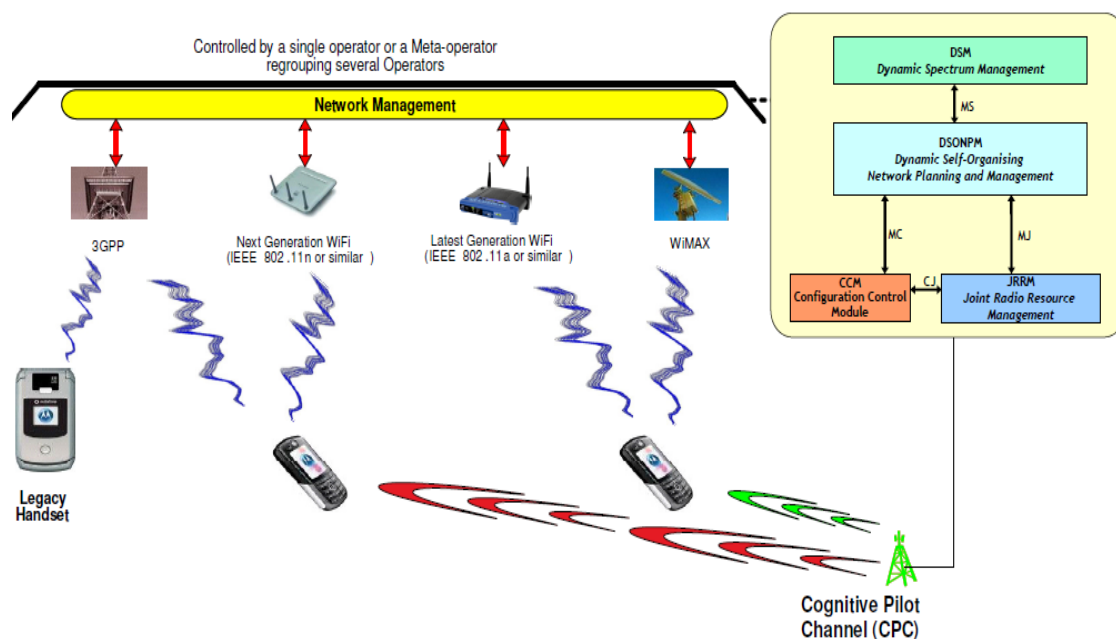

CPC to support the user terminal for an efficient discovery of the available radio accesses and reconfiguration management in heterogeneous wireless environment.

Source: Jens Gebert "Cognitive Reconfigurable Radio Systems and Networks: ETSI RRS Standardization Activities"  
<http://learning.ericsson.net/mllearning2/files/workpackage5/book.doc>



# EUWB

- **Coexisting Short Range Radio by Advanced Ultra-Wideband Radio Technology**

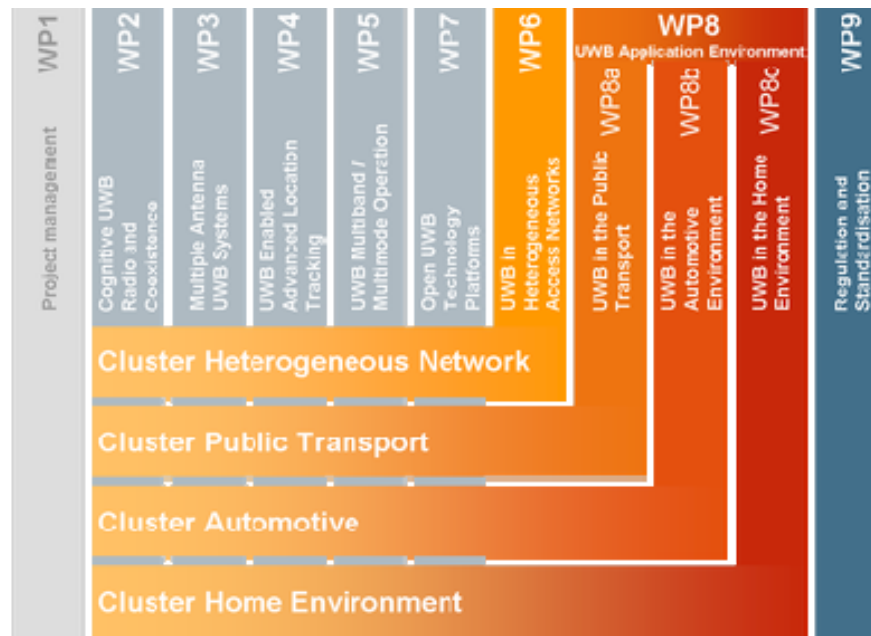

Source: <http://141.56.111.33/project-summary/technical-approach>

## Conclusions

- **The main ITU activities for TV Whitespace and cognitive radio are mainly under work party 1B (WP1B).**
  - WRC-11 agenda items 1.2, 1.19 and 1.22.
- **There is a strong correlation between the standardization efforts of 802 and 1900 and the Questions to be studied by ITU-R Study Groups.**
- **SDR is the closest radio technology to CRSs**

# Work in the SDR Forum

## How can 802 leverage work in SDR Forum for TV Whitespace Draft tutorial

Date: 2009-02-20

### Authors:

Name	Company	Address	Phone	E-mail
Lee Pucker	The SDR Forum	18631 N. 19th Ave, Suite 158-436, Phoenix, AZ 85027	+1-604-828-9846	<a href="mailto:Lee.Pucker@SDRForum.org">Lee.Pucker@SDRForum.org</a>

**Notice:** This document has been prepared to assist IEEE 802.19. It is offered as a basis for discussion and is not binding on the contributing individual(s) or organization(s). The material in this document is subject to change in form and content after further study. The contributor(s) reserve(s) the right to add, amend or withdraw material contained herein.

**Release:** The contributor grants a free, irrevocable license to the IEEE to incorporate material contained in this contribution, and any modifications thereof, in the creation of an IEEE Standards publication; to copyright in the IEEE's name any IEEE Standards publication even though it may include portions of this contribution; and at the IEEE's sole discretion to permit others to reproduce in whole or in part the resulting IEEE Standards publication. The contributor also acknowledges and accepts that this contribution may be made public by IEEE 802.19.

**Patent Policy and Procedures:** The contributor is familiar with the IEEE 802 Patent Policy and Procedures <<http://iee802.org/guides/bylaws/sb-bylaws.pdf>>, including the statement "IEEE standards may include the known use of patent(s), including patent applications, provided the IEEE receives assurance from the patent holder or applicant with respect to patents essential for compliance with both mandatory and optional portions of the standard." Early disclosure to the TAG of patent information that might be relevant to the standard is essential to reduce the possibility for delays in the development process and increase the likelihood that the draft publication will be approved for publication. Please notify the Chair <[shellhammer@ieee.org](mailto:shellhammer@ieee.org)> as early as possible, in written or electronic form, if patented technology (or technology under patent application) might be incorporated into a draft standard being developed within the IEEE 802.19 TAG. **If you have questions, contact the IEEE Patent Committee Administrator at <[patcom@ieee.org](mailto:patcom@ieee.org)>.**

## What is The SDR Forum

A nonprofit “mutual benefit corporation” dedicated to:

*“Promoting the success of next-generation radio technologies”*



## **SDR Forum and IEEE 802**

**The perception of the SDR Forum's 108 Member organizations:**

- **IEEE 802 – Air Interface Standards (Phy/MAC)**
- **IEEE SCC41 – Dynamic Spectrum Access**
  
- **SDR Forum – Next Generation Radio Technologies**
  - Supporting multiple air interface standards
  - Enabling dynamic spectrum access and cognitive radio

## **SDRF Projects Relevant to IEEE 802 ECSG**

- “Securing Software Reconfigurable Communications Technology”
- “Use Cases for MLM Language in Modern Wireless Networks”
- “Test Guidelines and Requirements for Secondary Spectrum Access of Unused TV Spectrum, also referred to as TV White Space”
- “Proposed Modifications to Working Document Towards a Preliminary Draft New Report on Cognitive Radio Systems in the Land Mobile Service”

# “Securing Software Reconfigurable Communications Technology”

- **Customers**

- Radio Manufacturers, Operators, Regulators

- **Purpose**

- Presents a set of threats common to Software Reconfigurable Communication Devices
- Presents a set of functional requirements for security mechanisms and counter measures that address this set

- **Status**

- In Technical Committee Ballot
- Project expected to complete by April meeting

- **Next Steps**

- Profiles for specific markets

## Requirements List

1. Policy-driven behavior
2. Stakeholder-driven Policy
3. Device attestation
4. Protected download
5. Policy-compliant installation and instantiation
6. Run-time control
7. Resource integrity
8. Access control
9. Audit
10. Process separation
11. Implementation assurance
12. Supportive operations

# Modeling Languages for Mobility

- Customers
  - Developers of next generation communications systems
- Purpose
  - Provides use cases, corresponding signalling plan, requirements and technical analysis for flexible and efficient communication protocols information exchanges that enable:
    - Vertical and horizontal mobility
    - Spectrum awareness and dynamic spectrum adaption
    - Waveform optimization, capabilities
    - Feature exchanges

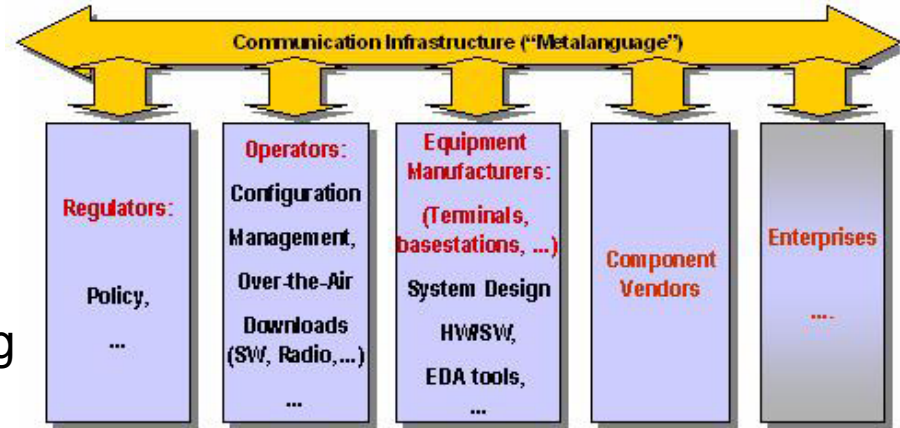

- Status
  - Use Cases and Requirements Document completed plenary ballot on January 28th
- Next Steps
  - Develop an ontology as the next step toward creating a language specification/API



# Test Guidelines and Requirements for Secondary Spectrum Access of Unused TV Spectrum

- Customers
  - Radio Manufacturers and Regulators
- Purpose
  - Defines the usage models and test requirements for personal portable devices operating in TV White Space to provide a basis for test and certification

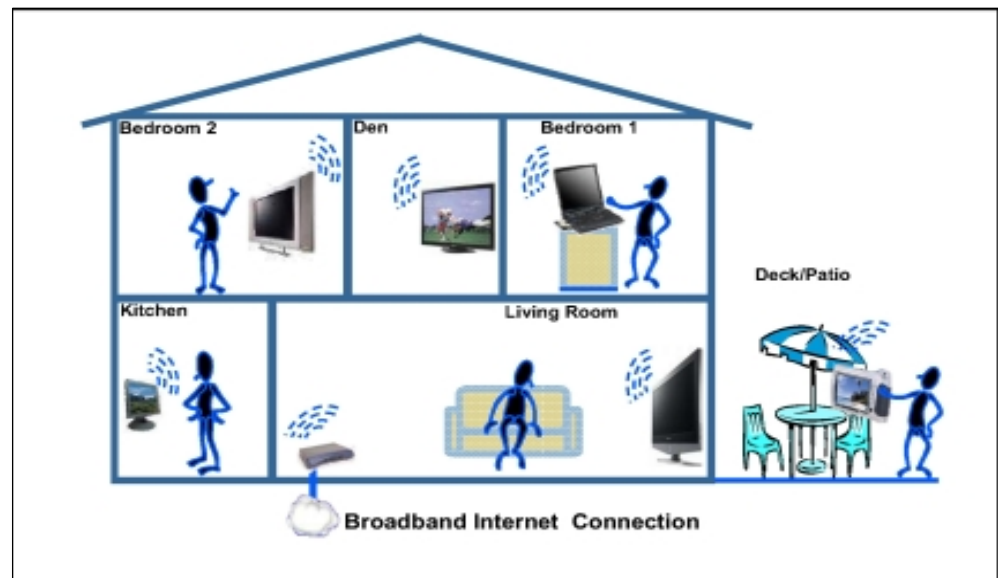

# Defining test procedures for white space devices

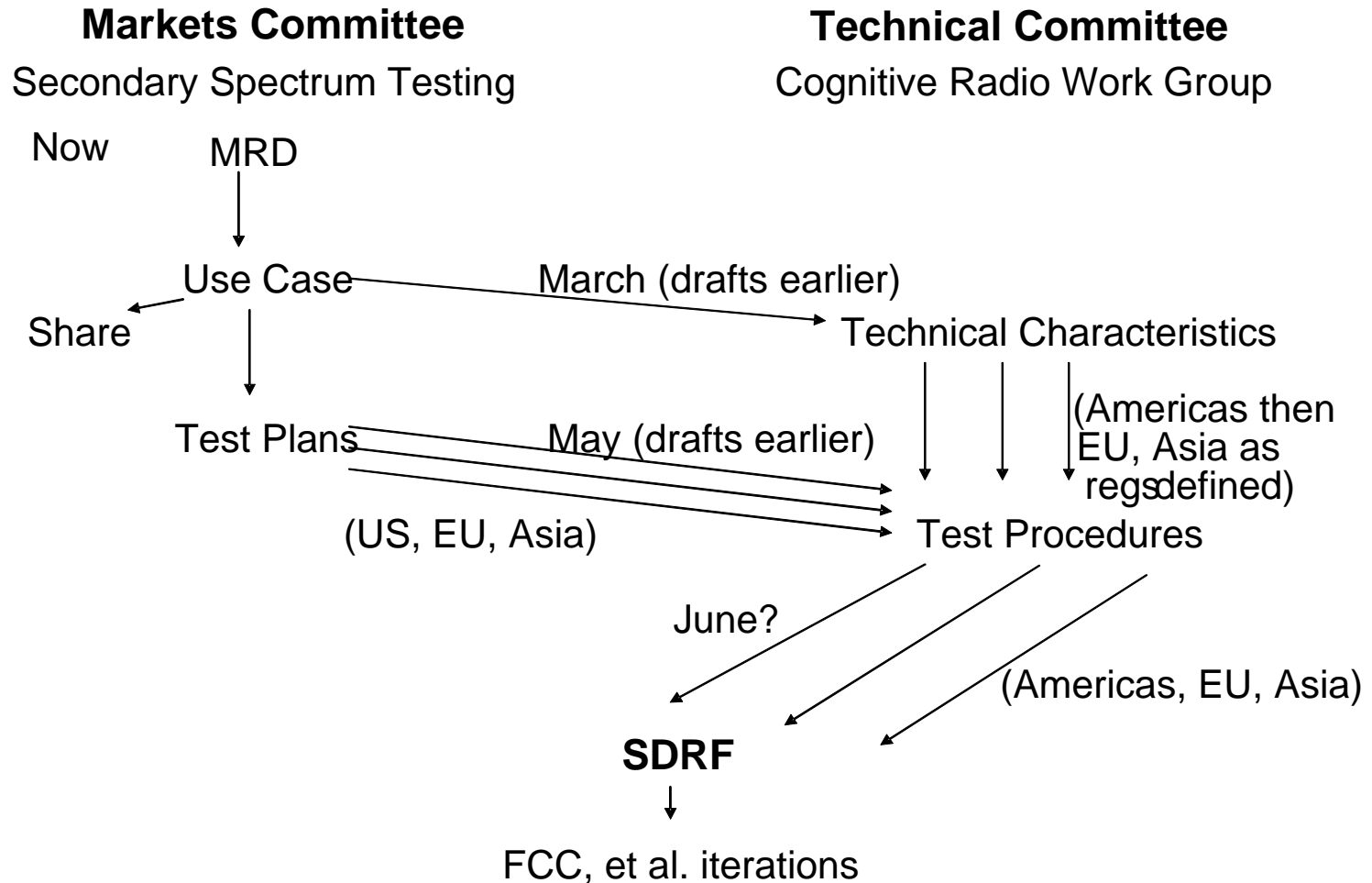

**PROPOSED MODIFICATIONS TO WORKING DOCUMENT TOWARDS A  
PRELIMINARY DRAFT NEW REPORT [Doc. 5A/TEMP/26(Rev.1)]**

- **Customer**
  - ITU-R Study Group 5 Working Party 5A
  - Submittal was developed at the request of the SDR Forum Regulatory Advisory Committee
- **Purpose**
  - Lays the groundwork for regulatory organizations to understand the benefits and system design choices associated with cognitive radio technologies
- **Status**
  - Document was balloted and approved in September of 2008
  - Document was submitted as a formal recommendation shortly thereafter
- **Next Steps**
  - SDR Forum will continue to evolve this document as appropriate, based on feedback from the ITU

# Other Relevant Projects Under Consideration

- **Common Database Standards**
- **Spectrum Etiquettes**
- **Information Process Architecture**

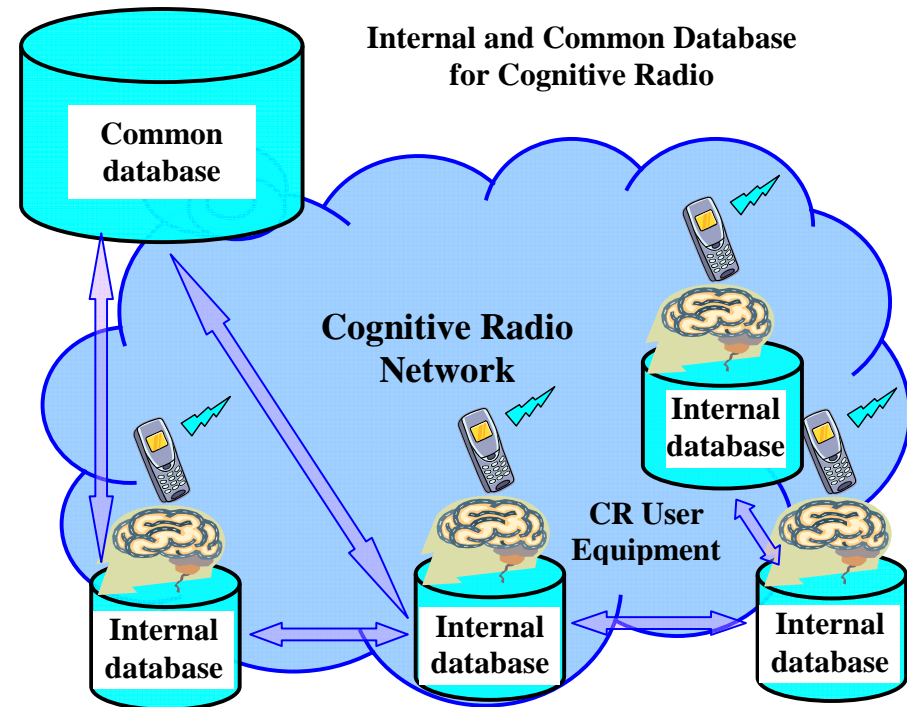

Internal Database and Common Database for Cognitive Radios. (Adapted from Figure 11-1 in "Cognitive Radio Technology," Bruce Fette, ed., 1<sup>st</sup> edition, Elsevier, 2006)

# Relevance of These Products to IEEE 802

- **“Securing Software Reconfigurable Communications Technology”**
  - An architecture created by security experts that can accelerate IEEE802 standards while helping avoid common pitfalls.
  - Serves as a tutorial on all the topics that need to be covered in the security aspects of any TV White Space standard
- **“Use Cases for MLM Language in Modern Wireless Networks”**
  - A language being created by programming language and AI experts for talking about flexible and cognitive radio systems.
  - Intended for machine-to-machine communication, e.g. the interaction between TVBDs and the database.
- **“Test Guidelines and Requirements for Secondary Spectrum Access of Unused TV Spectrum, also referred to as TV White Space”**
  - Certification test is critical for TVBDs.
  - IEEE802 can interact with all stakeholders though interaction with this SDRF project
- **“Proposed Modifications to Working Document Towards a Preliminary Draft New Report on Cognitive Radio Systems in the Land Mobile Service”**
  - Affecting the ITU requires coordination of common positions.
  - The SDRF is active on cognitive radio topics already and is on record with the ITU
  - The IEEE would be more likely to accomplish its goals if efforts are coordinated where our interests overlap.