

IETF Reliable Available Wireless (RAW)

IEEE 802 Plenary Tutorial

Carlos J. Bernardos, cjbc@it.uc3m.es, affiliation: Universidad Carlos III de Madrid, PREDICT-6G

Professor, Universidad Carlos III de Madrid

RAW/DetNet contributor, editor, document shepherd, IETF MADINAS WG co-chair

János Farkas, janos.farkas@ericsson.com, affiliation: Ericsson

Principal Researcher – Deterministic Networking, Ericsson Research, Hungary

IETF DetNet WG co-chair, IEEE 802.1 TSN TG chair

Before We Get Started – Disclaimer

- This presentation should be considered as the personal views of the presenters not as a formal position, explanation, or interpretation of IEEE.
- Per IEEE-SA Standards Board Bylaws, December 2017
 - “At lectures, symposia, seminars, or educational courses, an individual presenting information on IEEE standards shall make it clear that his or her views should be considered the personal views of that individual rather than the formal position of IEEE.”

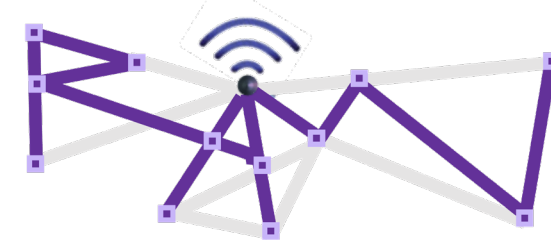

Abstract

- The IETF Deterministic Working (DetNet) Working Group has been standardizing technologies to provide deterministic Layer 3 communications for various use cases including, e.g.: professional audio/video, electrical utilities, industrial machine-to-machine, and wireless (see more in RFC 8578). The Reliable and Available Wireless (RAW) WG has been established to extend the DetNet architecture and solutions to wireless networks, including multi-hop and/or heterogeneous wireless networks and the combination of wireless and wireline network segments. This tutorial gives an overview on RAW and provides details on the following points:
 - Use cases and technologies considered by RAW.
 - An overview of the RAW framework architecture, including OAM mechanisms.

Agenda

- Introduction
- RAW use cases
- RAW technologies
- RAW architecture
- Operations, Administration, and Management (OAM)
- Summary

Agenda

- Introduction
- RAW use cases
- RAW technologies
- RAW architecture
- Operations, Administration, and Management (OAM)
- Summary

It all started in IEEE 802 ...

- Recognition:
- **IEEE SA Emerging Technology Award for the IEEE 802.1 Working Group**
- *For the development of IEEE Std 802.1CM™-2018 Time-Sensitive Networking for Fronthaul as amended by IEEE Std 802.1CMde™-2020, the first IEEE standard to connect a cellular network's radio equipment to its remote controller via a packet network, in particular, over a bridged IEEE 802.3™ Ethernet network.*



Deterministic Communications

- **The Right Packet at The Right Time**
 - **Deterministic data packet delivery**
 - Packet delivery within a time window without loss or delay due to congestion or errors

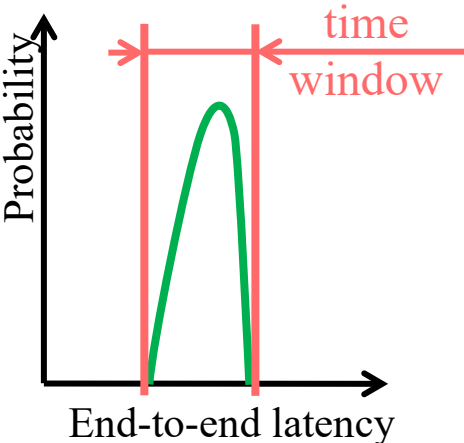

- **IEEE 802.1 Time-Sensitive Networking (TSN)** at Layer 2 (bridging)
- **IETF Deterministic Networking (DetNet)** at Layer 3 (IP/MPLS routing)

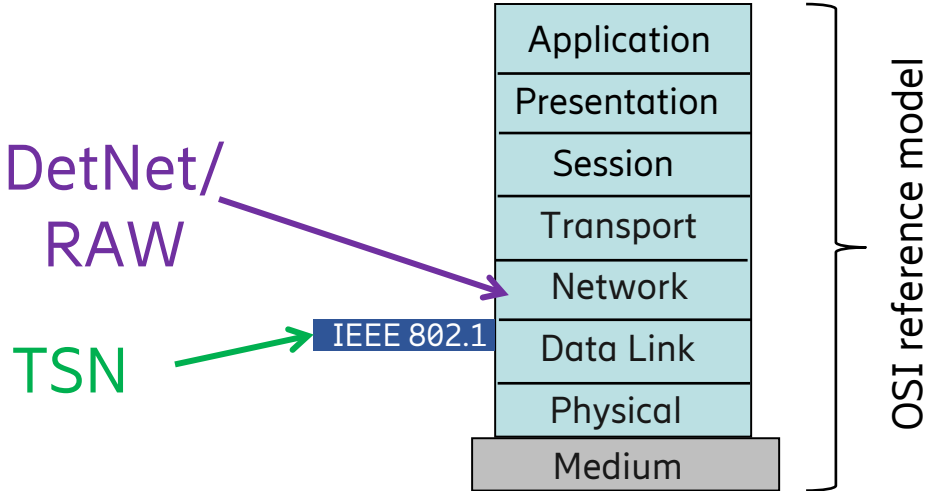

• NOTE – Started wireline. Meaning of “deterministic” might be refined for wireless.

IETF DetNet Charter

- The Deterministic Networking (DetNet) Working Group focuses on deterministic data paths that operate over Layer 2 bridged and Layer 3 routed segments, where such paths can **provide bounds on latency, loss, and packet delay variation (jitter), and high reliability**. The Working Group addresses **Layer 3 aspects in support of applications requiring deterministic networking**. The Working Group collaborates with IEEE802.1 Time-Sensitive Networking (TSN), which is responsible for Layer 2 operations, to define a **common architecture for both Layer 2 and Layer 3**. Example applications for deterministic networks include professional and home audio/video, multimedia in transportation, engine control systems, and other general industrial and vehicular applications being considered by the IEEE 802.1 TSN Task Group.

....

- <https://datatracker.ietf.org/wg/detnet/about>

RFC 8578 – DetNet Use Cases

2. Pro Audio and Video
3. Electrical Utilities
4. Building Automation Systems
5. Wireless for Industrial Applications
6. Cellular Radio
7. Industrial Machine to Machine
8. Mining Industry
9. Private Blockchain
10. Network Slicing

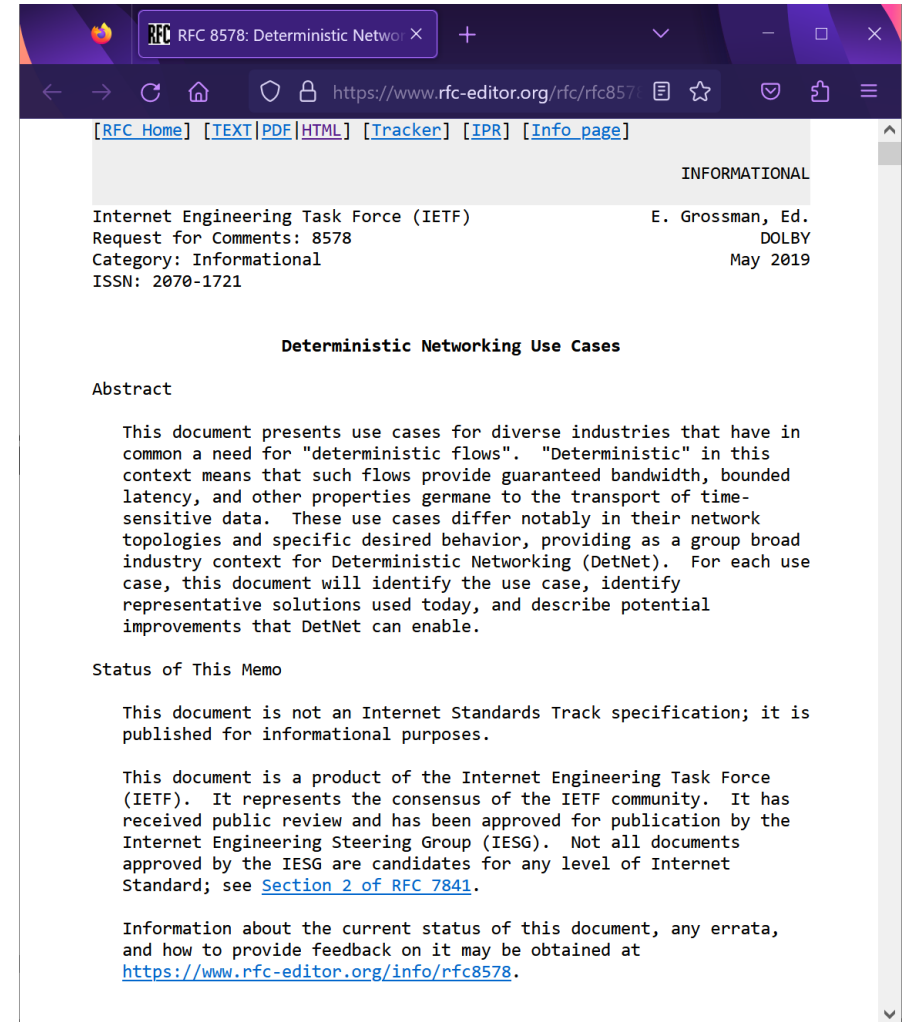

DetNet Controller Plane & Network Plane so far

- 1st package of DetNet standards follow Software Defined Networking (SDN) approach

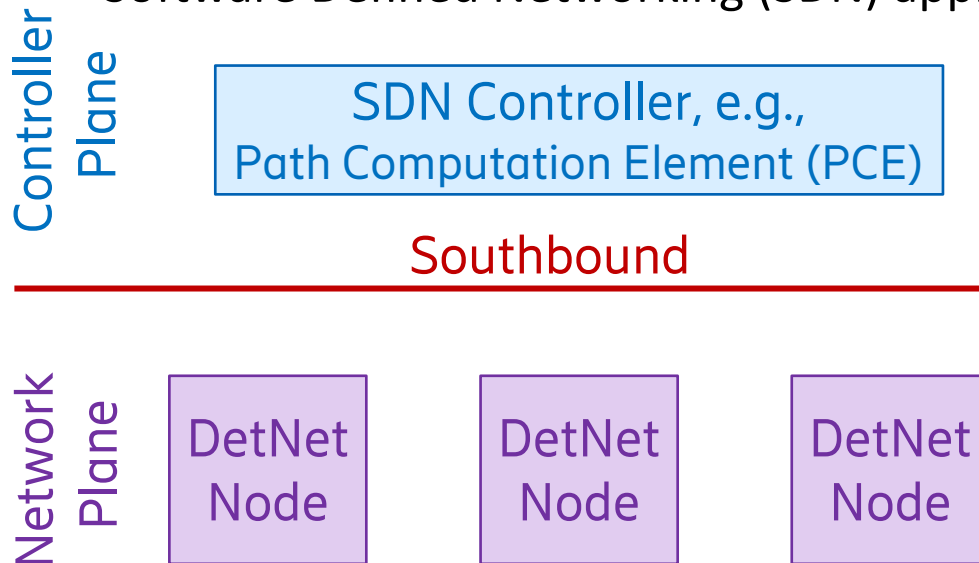

- **No new header field in data plane!**
- Just specific use of existing header fields

- [draft-ietf-detnet-controller-plane-framework](#) (ongoing)

- [RFC 9016 DetNet Flow Information Model](#)
- [draft-ietf-detnet-yang](#) (publication requested)

- [RFC 8938 DetNet Data Plane Framework](#)
- [RFC 8939 DetNet Data Plane: IP](#)
- [RFC 8964 DetNet Data Plane: MPLS](#)
- [RFC 9025 DetNet Data Plane: MPLS over UDP/IP](#)
- [RFC 9056 DetNet Data Plane: IP over MPLS](#)
- [RFC 9023 IP over TSN](#)
- [RFC 9037 MPLS over TSN](#)
- [RFC 9024 TSN VPN over MPLS](#)

DetNet Building Blocks

- Service protection
 - Addresses random media errors and equipment failures.
 - Packet Replication, Elimination, and Ordering Functions (PREOF) on disjoint paths
- Congestion protection
 - Addresses latency and packet loss due to congestion.
 - Allocates resources along the path of a DetNet flow, e.g., buffer space or link bandwidth
- Explicit routes
 - Addresses impact of the convergence of routing protocols (i.e., temporary interruptions).
 - DetNet uses already defined explicit routing techniques, does not define new one.
- Note: Synchronization for DetNet is provided by lower layers, e.g., TSN. See TSN components at <https://1.ieee802.org/tsn>

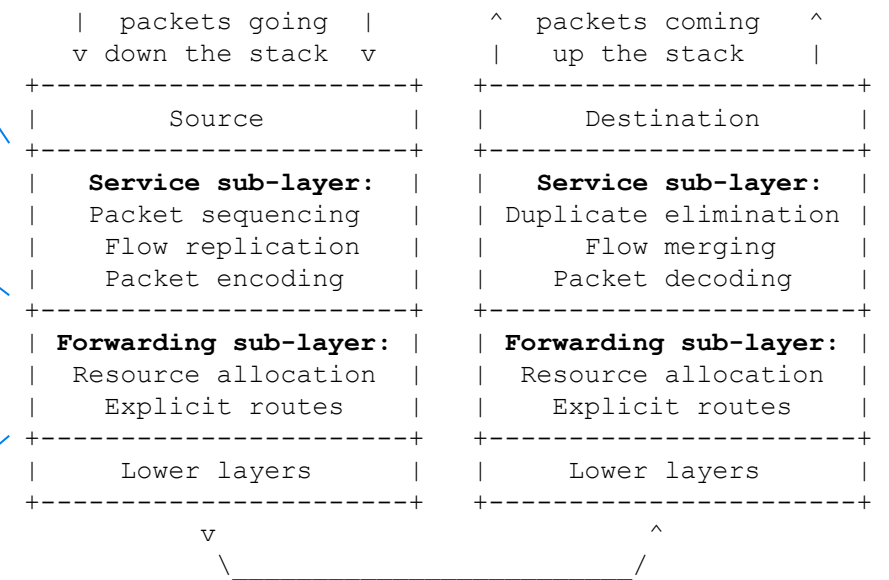
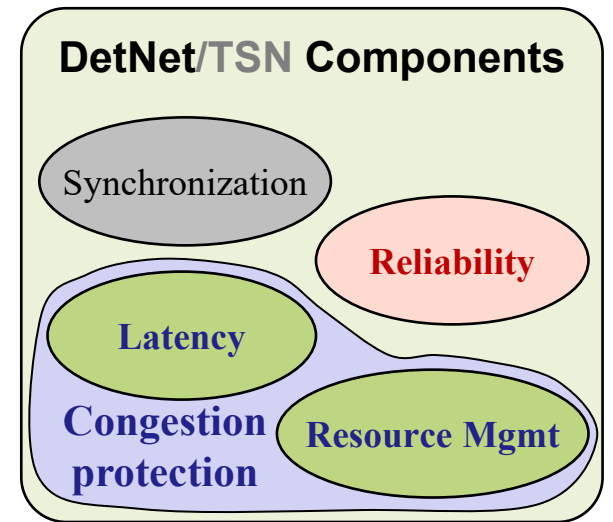

DetNet functionality is implemented in two adjacent sub-layers in the protocol stack

DetNet Status

1st package of DetNet standards

- RFC 8557: Problem statement
- RFC 8578: Use cases
- RFC 8655: Architecture
- RFC 8938, RFC 8939, RFC 8964, RFC 9025, RFC 9056, RFC 9023, RFC 9037, RFC 9024: Data Plane
- RFC 9016: Flow information model
- RFC 9055: Security
- RFC 9320: Bounded Latency
- YANG

Ongoing Work

- Operations, Administration, and Maintenance (OAM)
 - [OAM Framework](#)
 - [MPLS OAM](#)
 - [IP OAM](#)
- [Controller Plane Framework](#)
- Data plane add-ons
 - [Packet Replication, Elimination, and Ordering Functions \(PREOF\) via MPLS over UDP/IP](#)
 - [Packet Ordering Function \(POF\)](#)
- Regular meetings on enhanced data plane
 - <https://wiki.ietf.org/en/group/detnet/wmosq>
 - [Scaling requirements](#)
 - Several contributions submitted for DetNet queueing
 - Discussions are ongoing
 - None of them selected yet by the WG

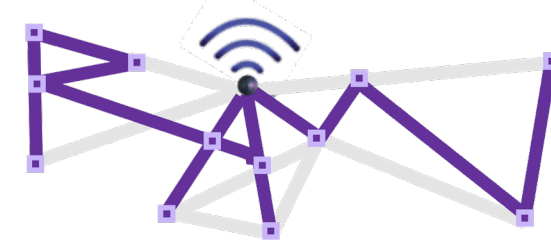

Reliable Available Wireless (RAW) WG

- Dedicated WG established to **extend the DetNet concepts to provide high reliability and availability for an IP network utilizing scheduled wireless segments and other wireless media**. ...
<https://datatracker.ietf.org/wg/raw/about>
- RAW WG has achieved key milestones
- RAW WG is being folded to DetNet WG for wider community work
- [RFC 9372](#) L-Band Digital Aeronautical Communications System (LDACS)
- [RAW Use Cases](#) – with RFC Editor
- [RAW Technologies](#) – wrapping up
- [OAM Features for RAW](#) – to be finalized in DetNet WG
- [RAW Architecture](#) – joint review by RAW and DetNet WGs
- [RAW Framework](#) – to be done after the architecture

Agenda

- Introduction
- **RAW use cases**
- RAW technologies
- RAW architecture
- Operations, Administration, and Management (OAM)
- Summary

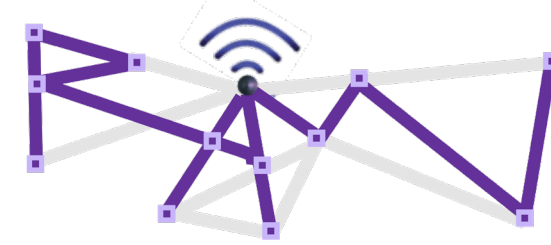

RAW use cases

- Different use cases considered in draft-ietf-raw-use-cases:
 - Aeronautical Communications
 - Amusement Parks
 - **Wireless for Industrial Applications**
 - Pro Audio and Video
 - **Wireless gaming**
 - Unmanned Aerial Vehicles and Vehicle-to-Vehicle platooning and control
 - Edge Robotics control
 - Instrumented emergency medical vehicles
- Focus of this presentation
(due to time constraints)

Wireless for Industrial Apps.

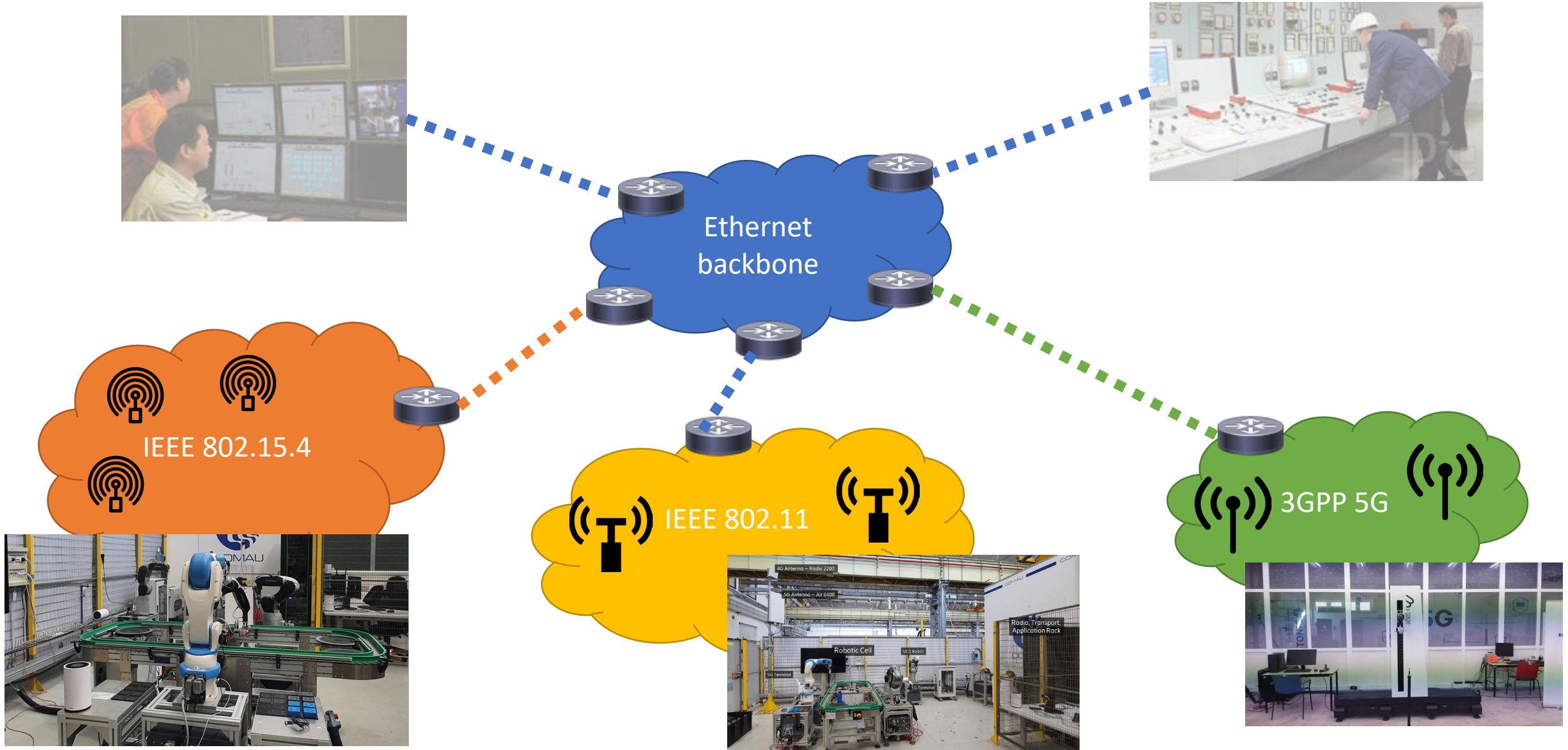

Wireless for Industrial Apps.: Specifics

- **Heterogeneous** technologies
- **Multiple** simultaneous links
- **Variable** link conditions (even with low mobility)
- **Different** needs/traffic types, e.g.:
 - Control loops: reliability is key
 - Monitoring and diagnostics: should not be mixed with previous

Wireless for Industrial Apps.: Requirements for RAW

- Solutions should support heterogeneous traffic
 - Capable of transporting both regular (multiplexed) flows and flows requiring predictable behavior
- Solutions should be able to work over multiple wireless access technologies
 - E.g., segment such as Time Slotted Channel Hopping (TSCH) [IEEE 802.15.4] and a backbone segment such as Ethernet

Wireless gaming

- The gaming industry includes different scenarios:
 - Real-time Mobile Gaming, very sensitive to network latency and stability
 - Wireless Console Gaming, requiring low latency and jitter
 - Wireless Gaming controllers, requiring low and stable end-to-end latency
 - Cloud Gaming, requiring low latency

Wireless gaming: Specifics

- Intra BSS latency: less than 5 ms
- Jitter variance: less than 2 ms
- Packet loss: less than 0.1%

Wireless gaming: Requirements for RAW

- Time-Sensitive Networking extensions, such as time-aware shaping and redundancy to address congestion and reliability problems
- Priority tagging (stream identification) to support differentiation of time-sensitive packets from other BE traffic
- Time-aware shaping, as defined in IEEE 802.1Qbv
- Dual/multiple link, to improve latency stability
- Admission control

Agenda

- Introduction
- RAW use cases
- **RAW technologies**
- RAW architecture
- Operations, Administration, and Management (OAM)
- Summary

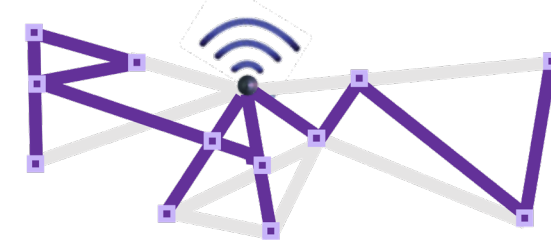

RAW technologies

- Describes 4 recent technologies that are capable of time synchronization and scheduling of transmission, making them suitable to carry time-sensitive flows with high reliability and availability
 - IEEE 802.11
 - 802.11ax (high efficiency)
 - 802.11be (extreme high throughput)
 - 802.11ad and 802.11ay (mmWave)
 - IEEE 802.15.4
 - 5G
 - L-band Digital Aeronautical Communications System (LDACS)

RAW technologies example: 5G

- 3GPP Release 16 includes integration of 5G with TSN
 - The 5G System (5GS) appears from the rest of the network as one (or more) logical TSN bridge(s)
 - The 5GS includes TSN Translator (TT) functionality for the adaptation of the 5GS to the TSN bridged network and for hiding the 5GS internal procedures
 - The 5GS provides the following components:
 - interface to TSN controller, as per [IEEE802.1Qcc] for the fully centralized configuration model
 - time synchronization via reception and transmission of gPTP PDUs [IEEE802.1AS]
 - low latency, hence, can be integrated with Scheduled Traffic [IEEE802.1Qbv]
 - reliability, hence, can be integrated with FRER [IEEE802.1CB]
- 3GPP Release 17 introduced enhancements to generalize support for Time-Sensitive Communications (TSC) beyond TSN
 - The 5GS acts as a “TSC node” in a more generic sense (which includes TSN bridge and IP node)
- 3GPP Release 18 introduced support for the 5GS to work as a logical DetNet node

RAW technologies example: 5G

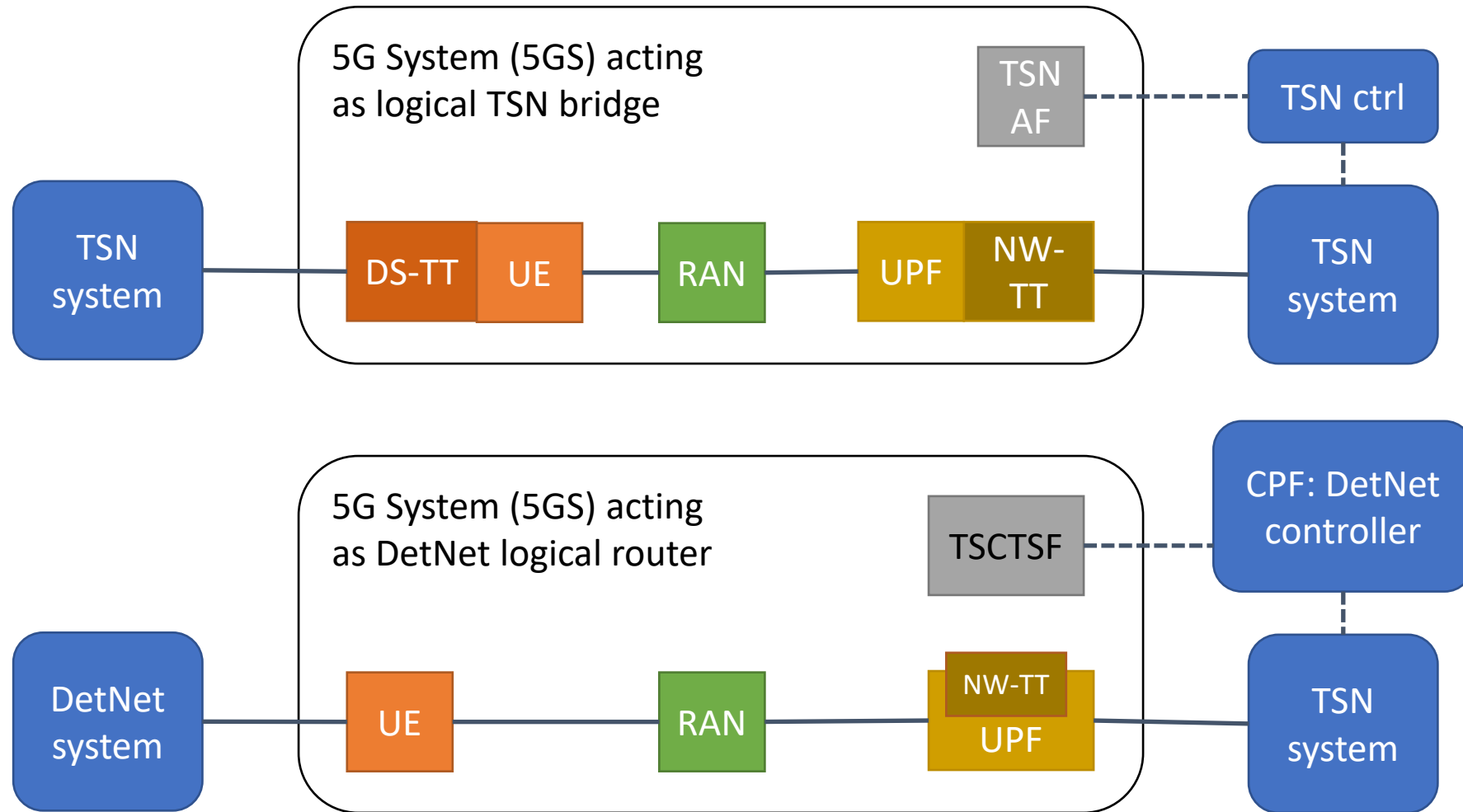

Agenda

- Introduction
- RAW use cases
- RAW technologies
- **RAW architecture**
- Operations, Administration, and Management (OAM)
- Summary

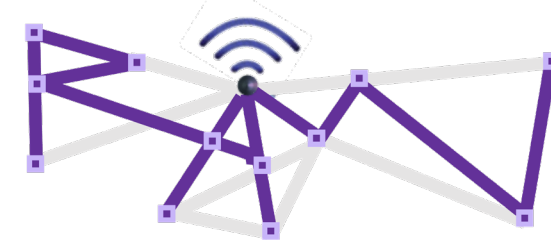

RAW architecture: terminology

- **PREOF**: Packet Replication, Elimination and Ordering Functions
- **PAREO**: Packet (hybrid) ARQ, Replication, Elimination and Ordering.
 - Superset of PREOF that includes leveraging lower-layer (typically wireless) techniques such as short range broadcast, MUMIMO, PHY rate and other Modulation Coding Scheme (MCS) adaptation, constructive interference and overhearing, separately or in combination, to increase the end-to-end reliability
- **OODA**: Observe, Orient, Decide, Act loop
- **Path** (linear sequence of links and nodes) and **DetNet path** (may involve duplicates, fragments and network coding)
- **Track**: a networking graph that can be followed to transport packets with equivalent treatment, associated with usage metadata

RAW architecture: conceptual model

- The RAW planes

CFP: Control Plane Function
PCE: Path Computation Element

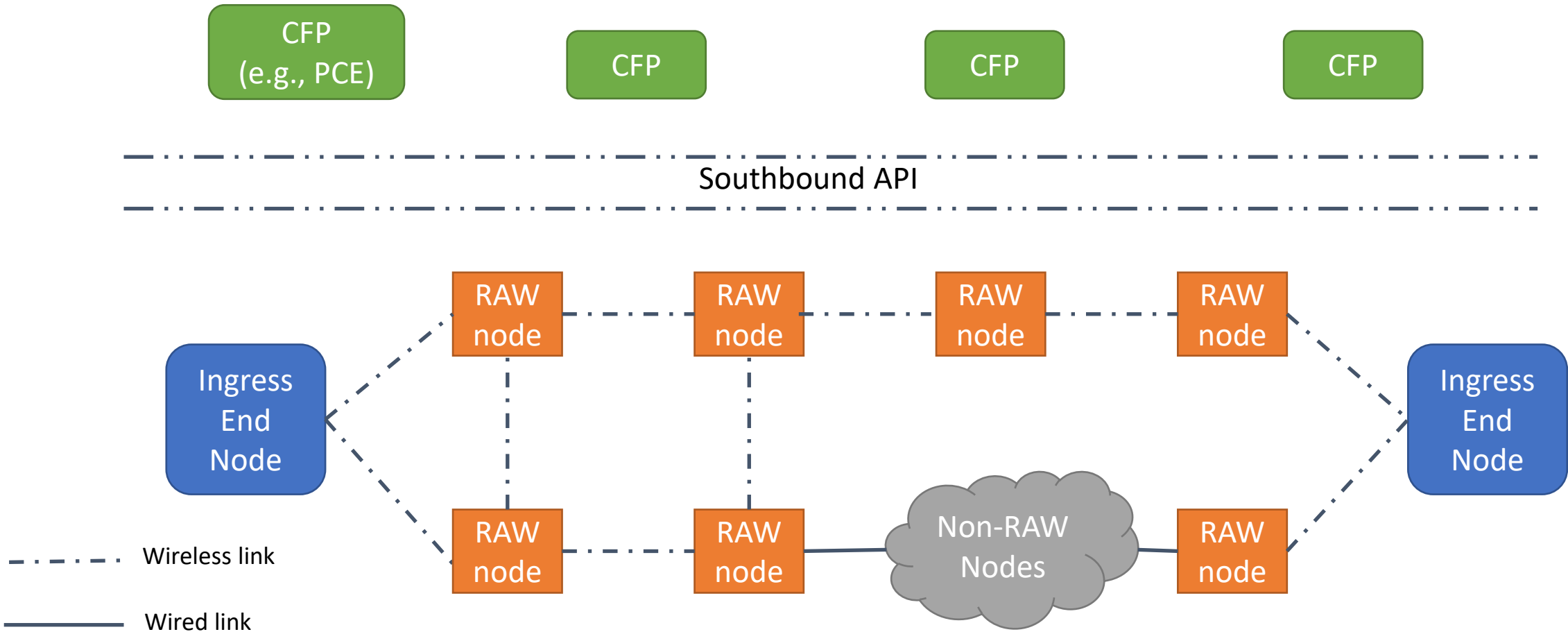

RAW architecture: conceptual model

- RAW and DetNet

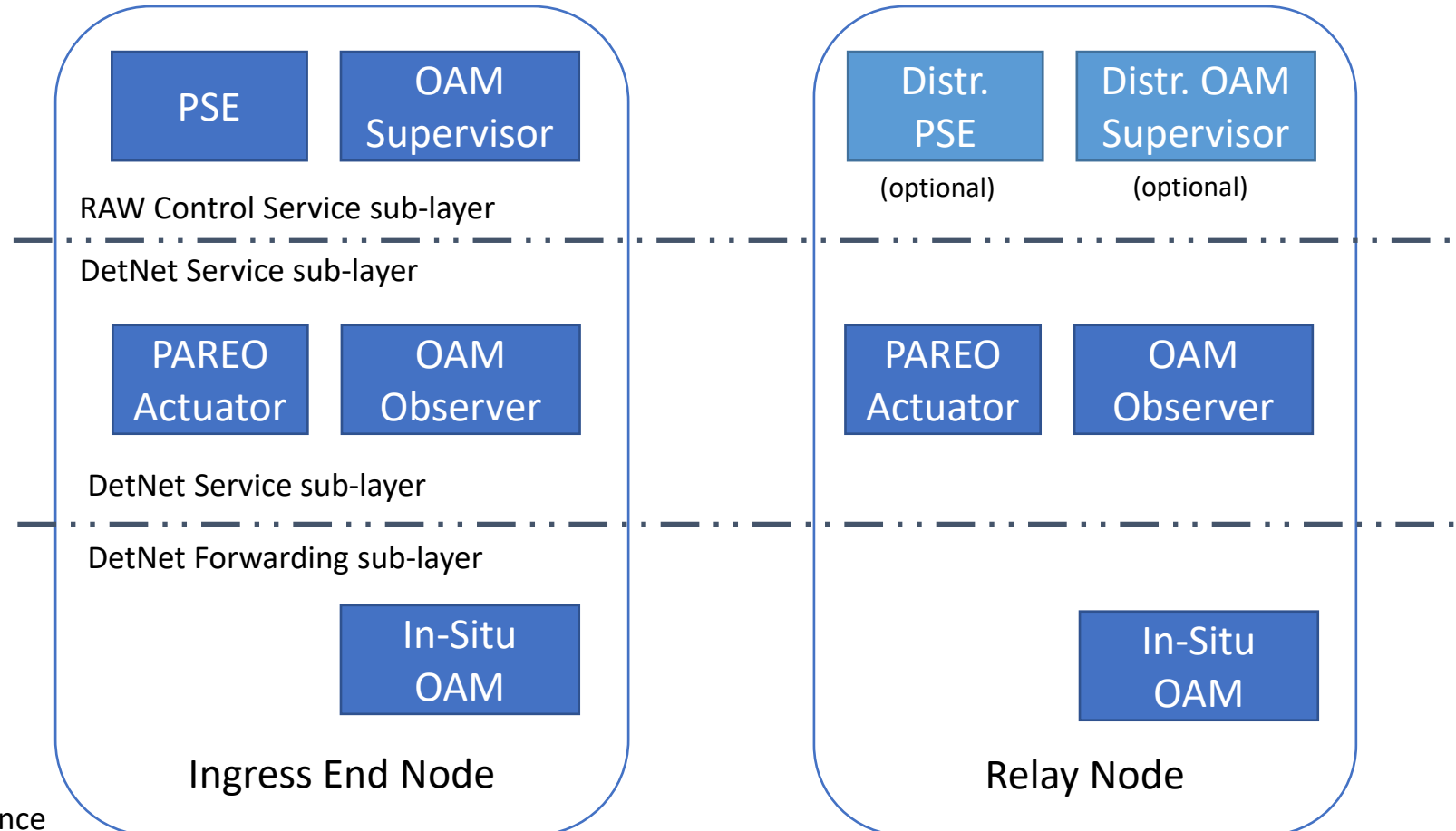

PSE: Path Selection Engine
OAM: Operations,
Administration and Maintenance

RAW architecture: conceptual model

- (Strict) RAW over DetNet

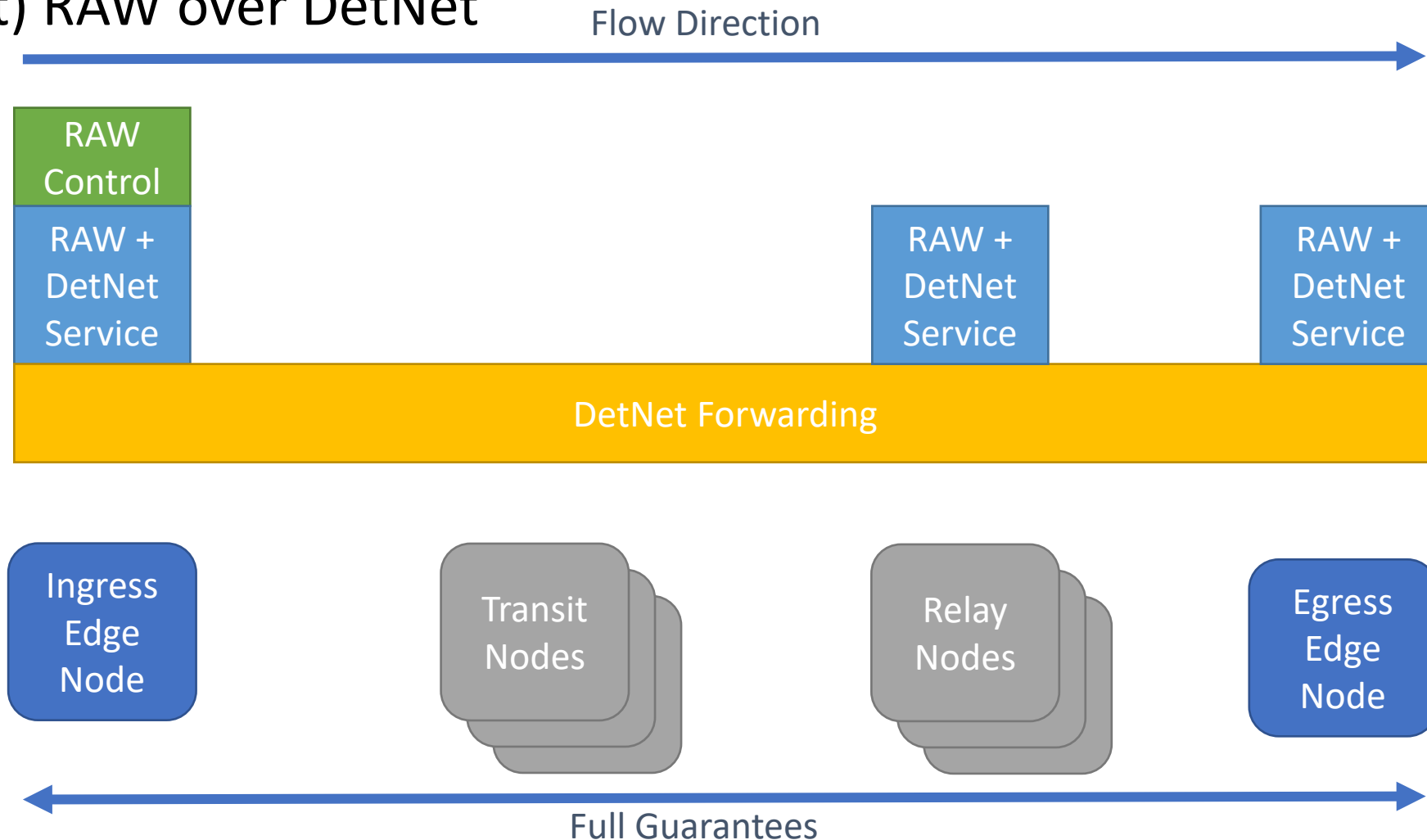

RAW architecture: the OODA loop

- **Observe:** Network Plane measurement protocols for Operations, Administration and Maintenance (OAM) to Observe some or all hops along a Track as well as the end-to-end packet delivery
- **Orient:** Controller plane elements to report the links statistics to a distributed or centralized control function such as a [Path Computation Element \(PCE\)](#), that computes and installs the Tracks, and provides meta data to Orient the routing decision
- **Decide:** A Runtime distributed [Path Selection Engine \(PSE\)](#) that Decides which DetNet Path to use for the next packet(s) that are routed along the Track
- **Act:** Packet (hybrid) ARQ, Replication, Elimination and Ordering (PAREO) Dataplane actions are controlled from the DetNet Service sublayer to increase the reliability of the end-to-end transmission

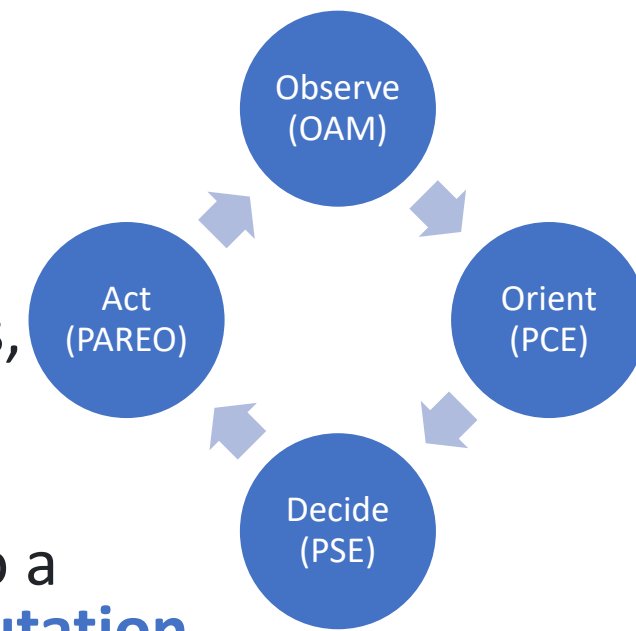

Agenda

- Introduction
- RAW use cases
- RAW technologies
- RAW architecture
- **Operations, Administration, and Management (OAM)**
- Summary

Operations, Administration, and Management (OAM)

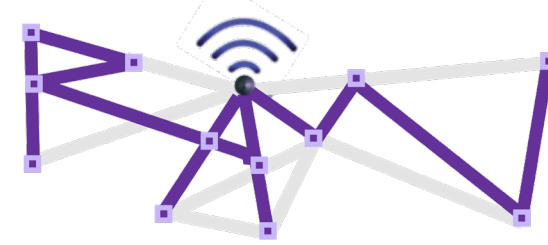

- RAW expects to exploit OAM to improve the RAW operation at the service and the forwarding sub-layers
 - OAM represents the core of the pre-provisioning process by supervising the network
 - DetNet OAM mechanisms can be used to monitor that PREOF is working correctly on a node and within the domain
 - OAM for RAW builds upon DetNet OAM
- Operation
 - Information Collection
 - Continuity Check
 - Connectivity Verification
 - Route Tracing
 - Fault detection
 - Fault identification
- Administration
 - Collection of metrics
 - Finer granularity
 - Efficient measurement retrieval (Passive OAM)
 - Reporting OAM packets to the source (Active OAM)
- Management
 - Transient state after reconfiguration
 - Predictions

Agenda

- Introduction
- RAW use cases
- RAW technologies
- RAW architecture
- Operations, Administration, and Management (OAM)
- **Summary**

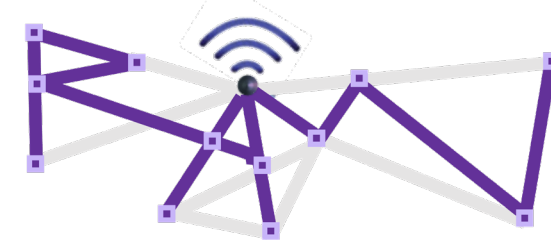

Summary

- 1st package of DetNet standards is ready
- RAW WG has been formed to focus on the use of DetNet in networks that include wireless segments
- RAW extends the DetNet concepts to provide high reliability and availability for an IP network including wireless media
- Use cases to be addressed by RAW and wireless technologies suitable for RAW have been collected
- RAW architecture and OAM drafted and going through review
- RAW WG is being folded to DetNet WG for wider community work

Recently Started EU Projects on The Subject



- <https://deterministic6g.eu>



- <https://predict-6g.eu>
- The work of Carlos J. Bernardos in this document has been partially supported by the Horizon Europe PREDICT-6G (Grant 101095890) project.



Thank You!

Q&A