

Roles and Functions in TSN Configuration



János Farkas

janos.farkas@ericsson.com

Preliminary Notes



- This presentation is about architectural considerations.
- Maintaining consistency in TSN standards is essential to provide a solid basis to build upon, e.g., for others standards development organizations.
- As long as they conform to the standards, implementations have their own freedom, e.g., in packaging functionalities.

Fully Centralized Model

IEEE Std 802.1Qcc-2018

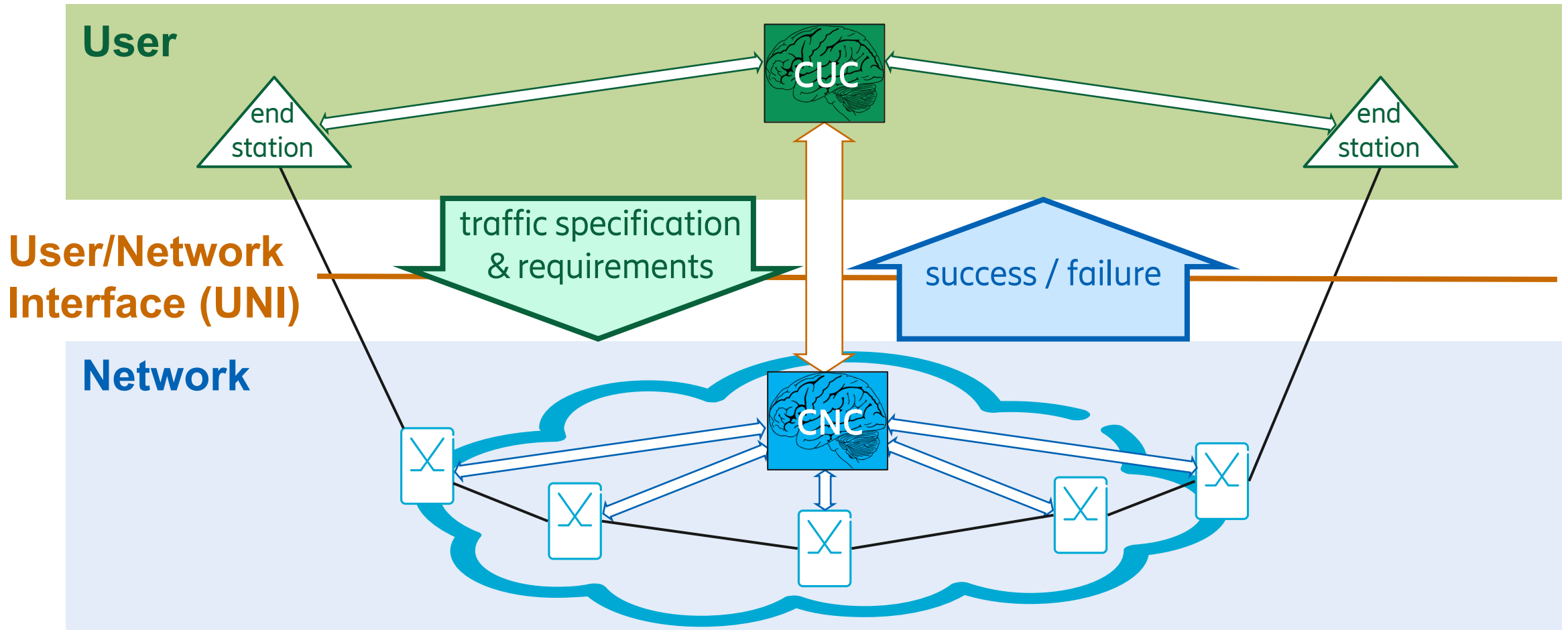

Centralized Network/Distributed User Model

IEEE Std 802.1Qcc-2018

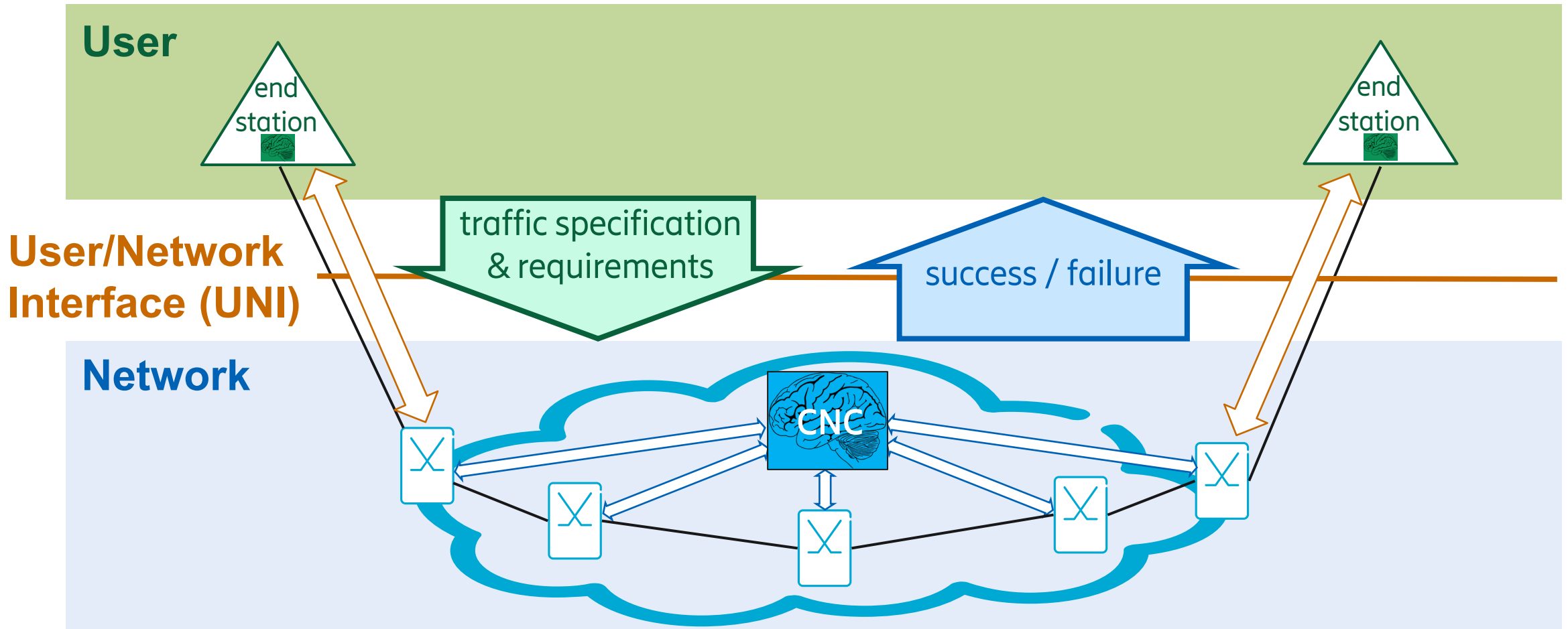

Fully Distributed Model

IEEE Std 802.1Qcc-2018

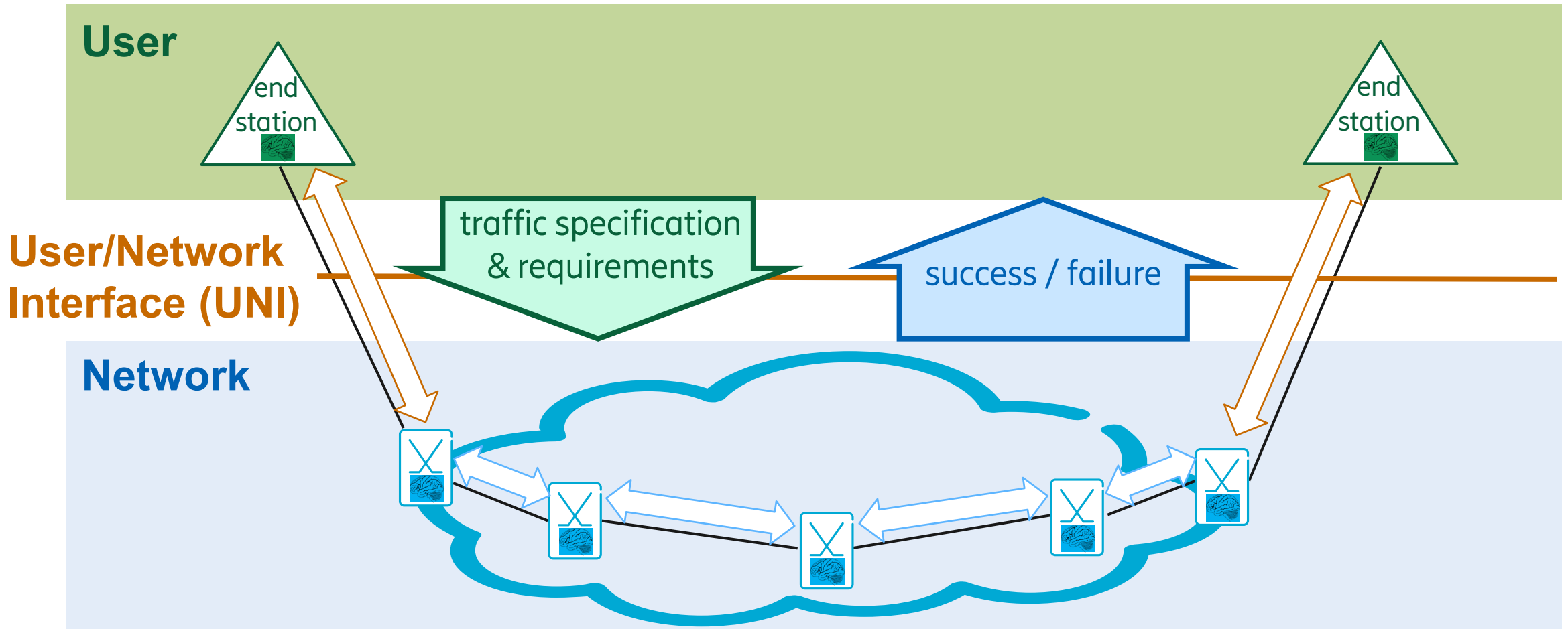

Fully distributed → No central entity at all

IEEE Std 802.1Qcc 46.1.3.1: "The network is configured in a fully distributed manner, without a centralized network configuration entity."

Network Configuration for TSN in Industrial Automation [≡] as per Proposals to IEC/IEEE 60802 by 2021-04-09

- Fully centralized
 - Based on <https://www.ieee802.org/1/files/private/60802-drafts/d1/60802-Steindl-Clause6Subclause8-0221-v6-clean.pdf>
 - includes “establish explicit paths through the network using the CNC” (does not call it PEE)
 - does not mention RAE, but the functionality needs to be there
- Distributed resource allocation by 802.1Qdd RAP
 - Based on <https://www.ieee802.org/1/files/private/60802-drafts/d1/60802-Dorr-Subclause4p3and6p8p3-DistributedConfiguration-0321-v02.pdf>
 - PEE type of entity is there as per 2021-03-26 IEC/IEEE 60802 System Ad Hoc. Does it imply CNC? Given that PEE functionality is part of CNC.

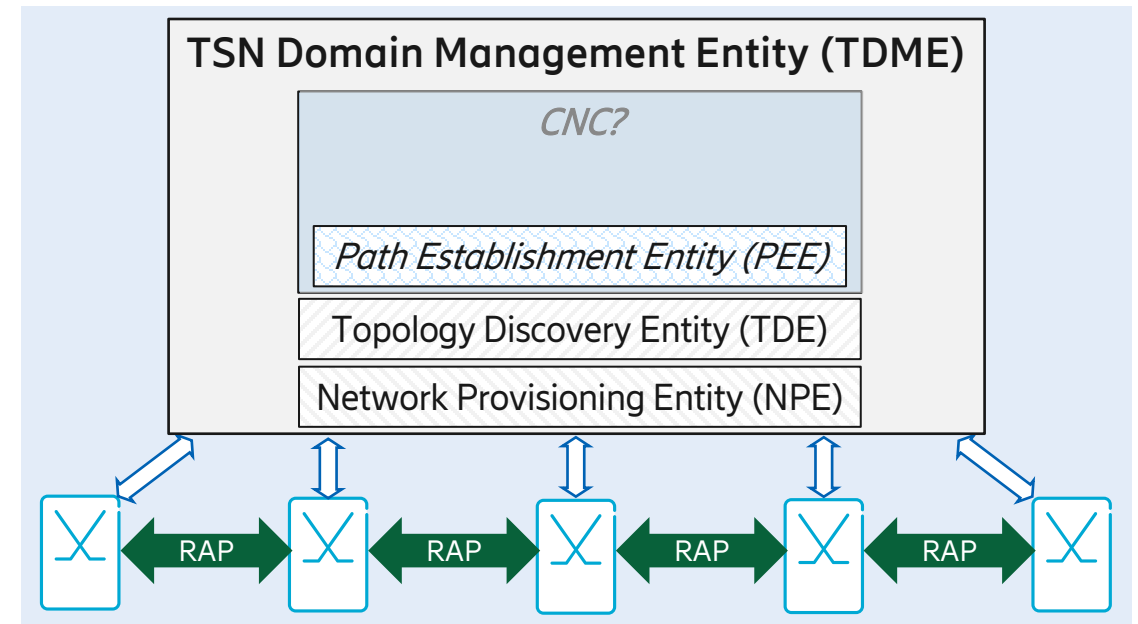
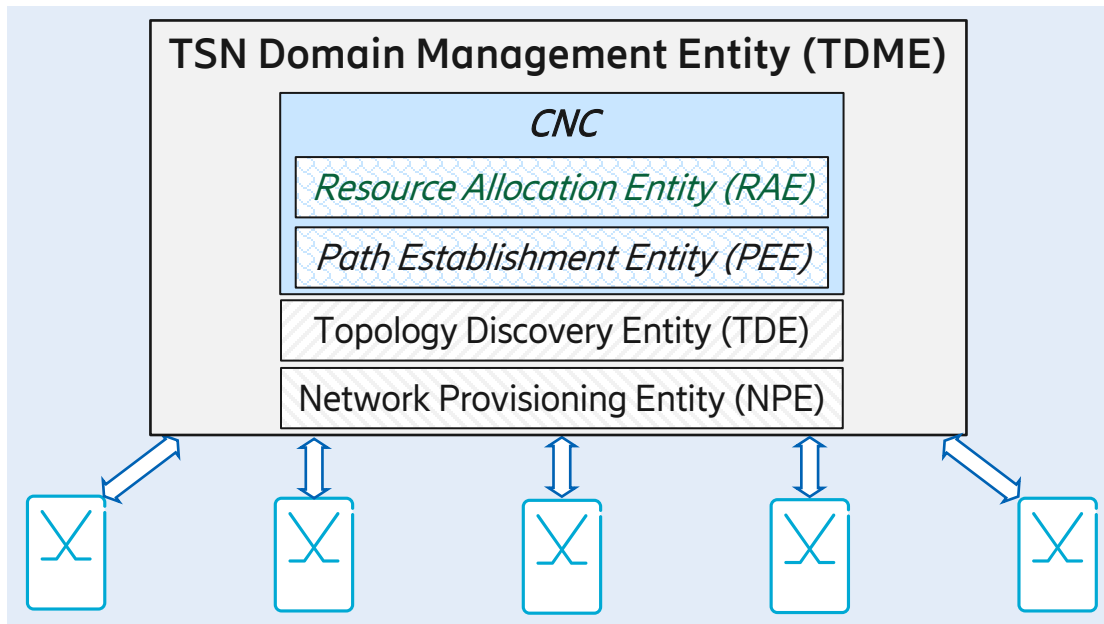

Network Configuration for TSN in Industrial Automation [≡] in-line with IEEE Std 802.1Qcc-2018

- 46.1.3.2: “The CNC has a complete view of the physical topology of the network as well as the capabilities of each Bridge.”
- 46.1.3.2 & 46.1.3.3: “The CNC uses remote management to discover physical topology, retrieve Bridge capabilities, and configure TSN features in each Bridge.”
- Fully centralized
- Distributed resource allocation by 802.1Qdd RAP

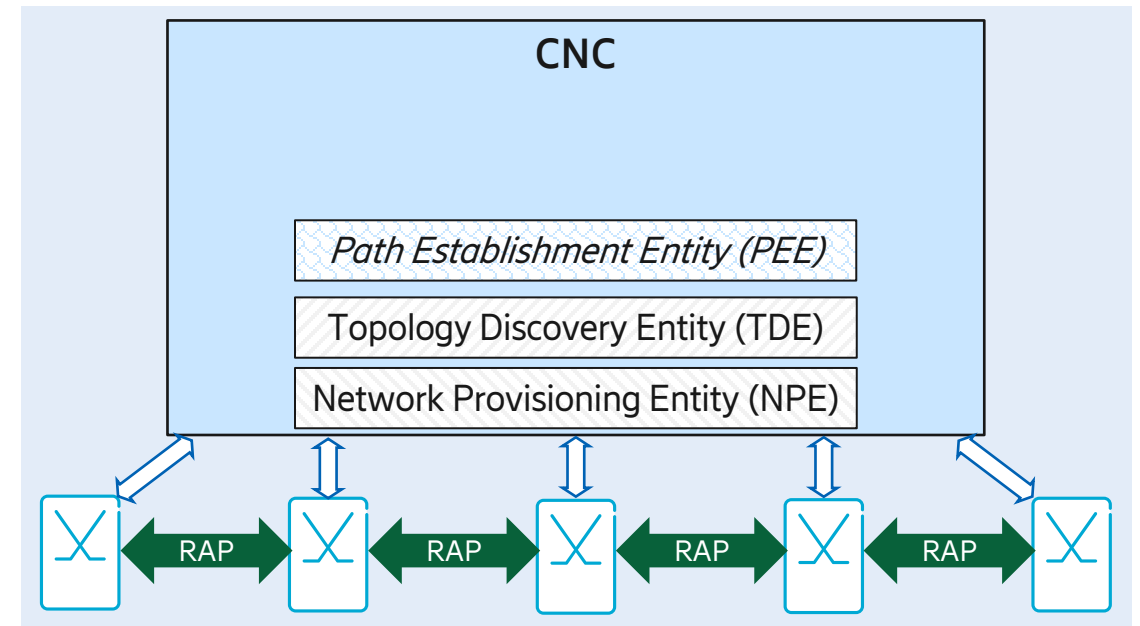
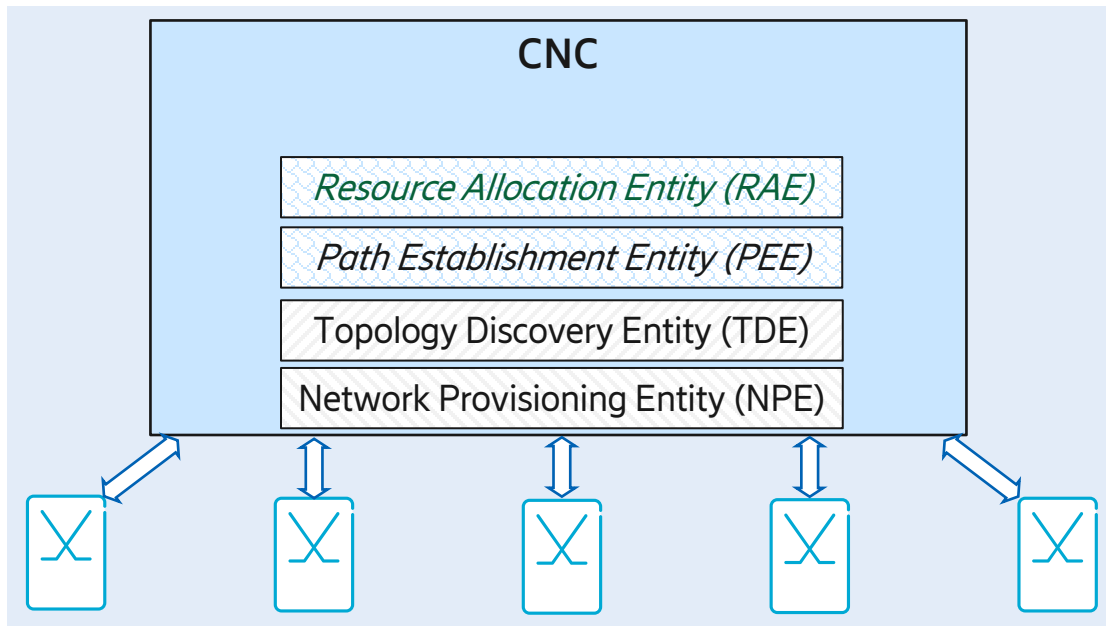

Comparison of Alternatives for Fully Centralized



- From slide 6:

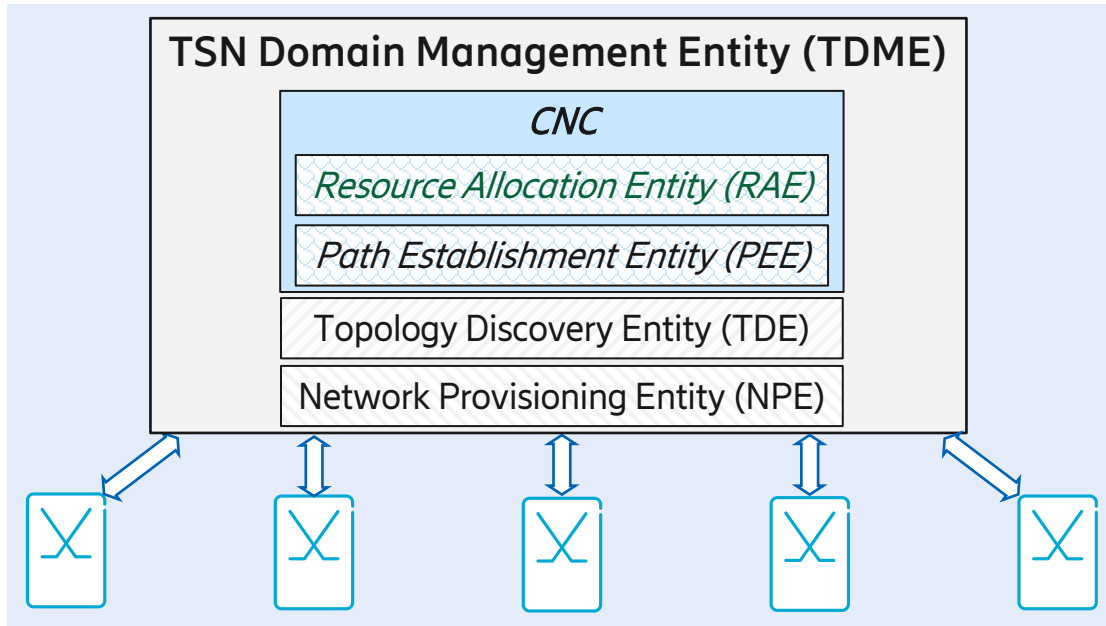

- This approach changes 802.1Qcc in an outside-in fashion by making the CNC internal to a new entity (TDME) facing the external components.

- From slide 7:

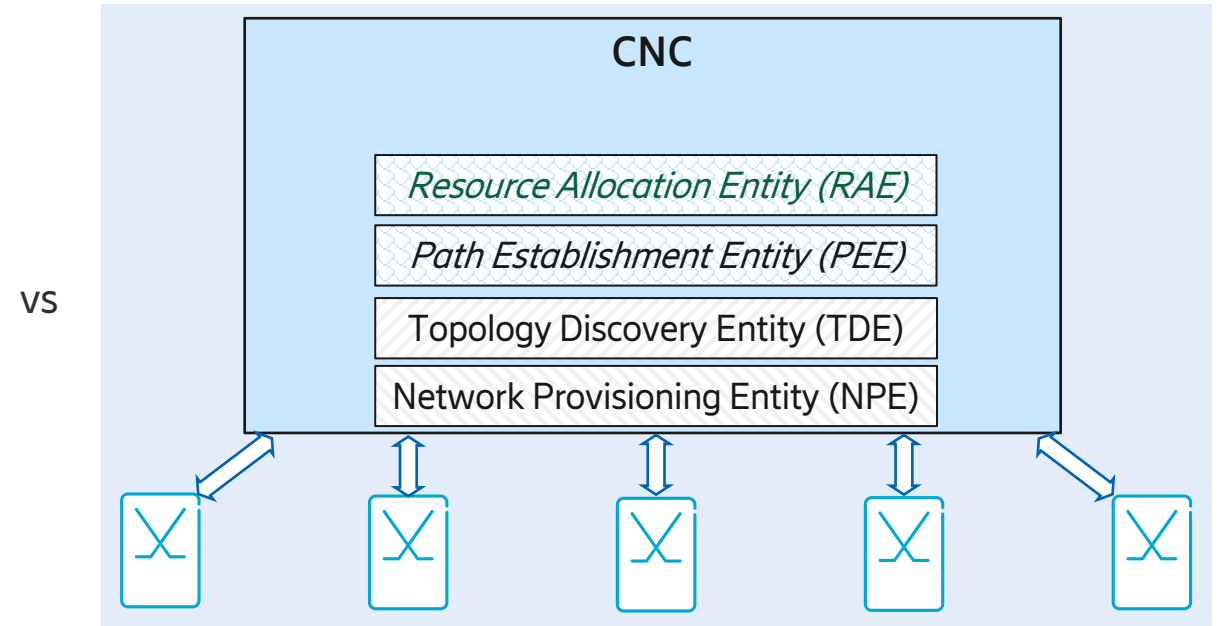

- This approach is in-line with IEEE Std 802.1Qcc, refines it and adds details.

Both approaches provide the same functionality, include the very same functions, only the "packaging" is different.

Other Standards Build Upon TSN Standards, e.g.: 3GPP 23.501

- LS on TSN support in 3GPP Release-16 stage 2 completion
<https://www.ieee802.org/1/files/public/docs2020/liaison-3GPP-S2-2003508-TSN-0420.pdf>
- Based on *Figure 4.4.8.2-1: System architecture view with 5GS appearing as TSN bridge* in [3GPP 23.501](#):

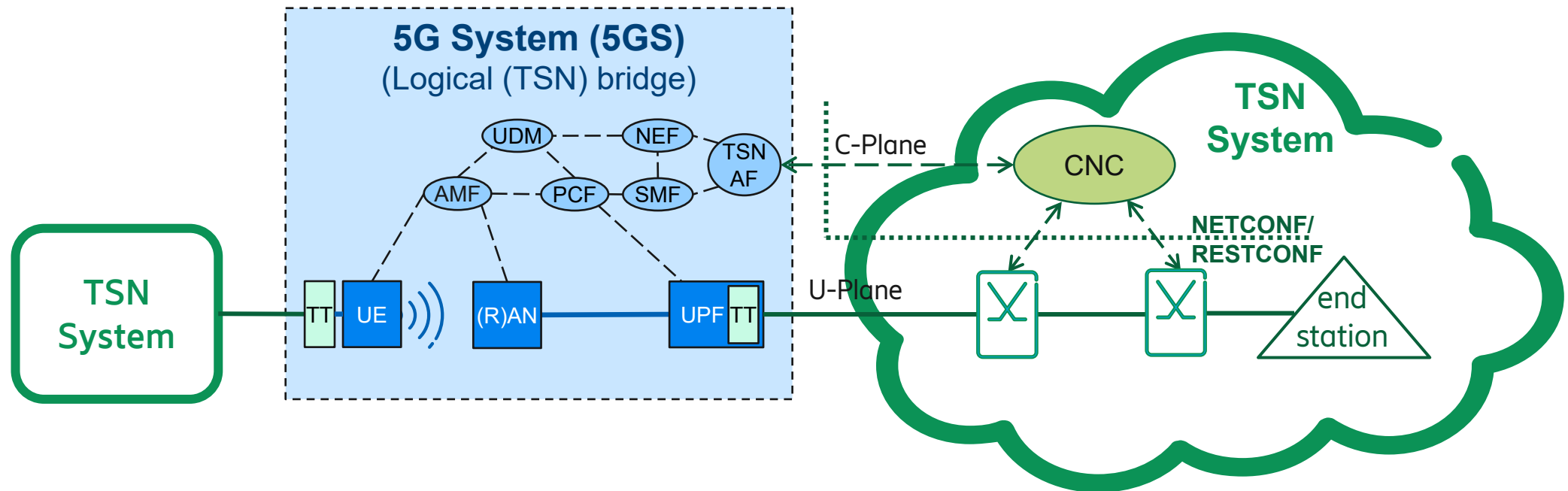



Thank you!