

Radio Controlled Clocks

Speaker/Author: Michael A. Lombardi
National Institute of Standards and Technology (NIST)
Time and Frequency Division
Boulder, Colorado 80305
Email: lombardi@boulder.nist.gov
Phone: (303) 497-3212; Fax: (303) 497-3228

Abstract

Radio controlled clocks have existed for decades, but have become far more common in the United States in recent years, due mainly to the explosion of new products that receive time signals from NIST radio station WWVB. This paper explores the history of radio controlled clocks, how they work, and the types of radio signals that control them.

1. Introduction

The next time someone asks the age old question of “What time is it?”, you can give them the exact answer, provided that you own a radio controlled clock (RCC). These clocks receive wireless time codes and synchronize to within a fraction of a second of Coordinated Universal Time (UTC). Some manufacturers refer to their radio controlled clocks as “atomic clocks”, but that description isn’t true. A real atomic clock has an atomic oscillator inside (such as a cesium or rubidium oscillator). A RCC has a radio inside, which receives a signal sent from a place where an atomic clock is located. And as we shall see, radio clocks existed long before atomic clocks were invented. Radio time signals were referenced to pendulum clocks, and later quartz clocks, before atomic clocks became reliable standards in the 1960s.

In one form or another, RCCs have been with us for nearly a century, but they were not made available to the average consumer until recently. Until the latter part of the 1990’s, most RCCs were expensive instruments designed for laboratory applications, or kits assembled by technically minded hobbyists. Now, low-cost RCCs are available everywhere, in the form of wall clocks, desk clocks, and wristwatches that synchronize to NIST radio station WWVB, or to similar stations in other countries. Other RCCs are embedded inside consumer electronic products such as cell phones, televisions, pagers, and car radios. This recent proliferation of RCCs represents one of the most significant developments in the history of timekeeping. In the not too distant future every clock that we look at might be synchronized to the correct time, a prospect that would have once seemed impossible.

2. The history of radio controlled clocks

It might surprise you to know that the concept of a radio controlled clock is nearly as old as the concept of radio itself. In fact, shortly after it was discovered that information could be sent by wireless transmissions, early radio scientists began looking for ways to send the time by radio from one location to another.

Most historians cite the experiments of the Italian inventor Guglielmo Marconi as the first radio broadcasts. Marconi’s scientific breakthroughs are well documented and widely known. Born in

1874, Marconi used a spark-gap transmitter and antenna to successfully send radio signals over a distance of over 2 km in 1895. By 1899 he had established wireless communications between France and England across the English channel, and in 1901, sent the first wireless signals across the Atlantic ocean. What is not widely known is that in the midst of Marconi's early work, a proposal was made to use the new wireless medium for the broadcast of time signals. In a talk given to the Royal Dublin Society in November 1898, the optical instrument maker and engineer Sir Howard Grubb first proposed the concept of a radio controlled clock [1]. Shortly after his talk, he published the following comments in the Society's proceedings:

There is something very beautiful in this action of the "Marconi" wave. In a city supplied with this apparatus we should be conscious as we hear each hour strike that above us and around us, swiftly and silently, this electrical wave is passing, conscientiously doing its work, and setting each clock in each establishment absolutely right, without any physical connection whatsoever between the central distributing clock, and those which it keeps correct by means of this mysterious electrical wave.

We might go even still further, and although I do not put it forward as a proposition likely to be carried out in any way, except as an experiment, yet it undoubtedly would be perfectly possible to carry an apparatus in one's pocket, and have our watches automatically set by this electrical wave as we walk about the streets [2].

Grubb's comments are remarkable because they predicted the radio controlled watch nearly 100 years before it finally appeared in 1990, and because they were made while the first radio experiments were still being conducted! You might find it interesting that he predicted a pocket watch rather than a wristwatch. This makes some sense when you consider that the first wristwatches for men did not appear until a few years later, although Cartier (and perhaps others) were producing lady's wristwatches in France at the time of Grubb's presentation.

2.1 Early Time Signal Broadcast Stations

Grubb's idea of a "central distributing clock" already existed at the time of his 1898 talk, since time signals were already being distributed via telegraph and other means prior to the invention of radio. When the first wireless time signals were introduced a few years later, the telegraph was sometimes used to send time from the reference clock to the broadcasting station. The first radio time signal is believed to have been broadcast in 1903 by the United States Navy, using a clock located at the United States Naval Observatory (USNO) site in Washington, DC. At least one source lists the first transmission site as Navesink, New Jersey [3], but regularly scheduled broadcasts apparently began on August 9, 1904 from the Navy Yard in Boston [4]. Within a few years, the Navy had sent time signals from a number of other sites, including Washington, New York, Norfolk, Newport, Cape Cod, and Arlington, Virginia, on the other side of the Potomac River from Washington. The first radio time signal outside the United States might have come from station VCS in Halifax, Nova Scotia, Canada. Broadcasts there began in 1907, referenced to the clock at St. John's Observatory [5].

More widely used time signal broadcasts began shortly afterwards. Beginning in 1910, the French Bureau of Longitudes broadcast time signals twice daily from a station installed at the top of the Eiffel Tower. The reference clocks were located at the nearby Paris Observatory, and the wavelength of the transmissions was 2000 m. The station, with the call letters FL, was intended

to allow ships at sea to correct their marine chronometers. However, it quickly attracted a great demand from railway companies, clock makers, jewelers, and others, who began to decode the signals and obtain the correct time. By 1913, the broadcast wavelength had been changed to 2500 m, and the format had been standardized [6]. Figure 1 shows a chart used by early radio operators to decode the broadcast and obtain the time.

The "Tempus" Time-Signal Receiver. Signal Charts.

On the two Charts below are shown by means of short and long strokes, the "dots" and "dashies" exactly as transmitted by the Eiffel Tower Wireless Station, and exactly as heard in the form of short and long "buzzes" in the telephones.

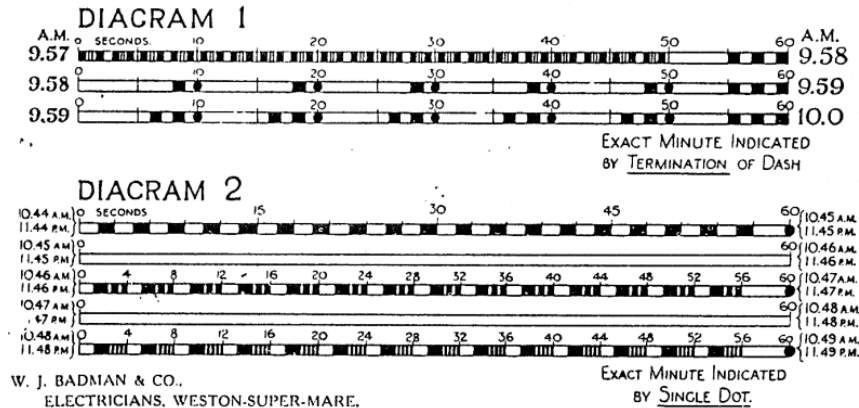

Figure 1. Signal Chart for the Eiffel Tower Time Code.

for demolition in 1909 at the expiration of its 20 year lease. By then, however, experimental radio time signals were already being broadcast, and the monument was spared due to its usefulness as a radio tower.

The first well known American time signal came from radio station NAA, located in Arlington, Virginia. NAA began broadcasting time signals in Morse Code in 1913 using a rotary spark-gap transmitter at a wavelength of 2500 m and an output power of about 54 kW [7]. The time came from a USNO clock, and it was said that the time sent from Arlington was accurate to "1/20 of a second" when it reached San Francisco. Figure 2 shows an early NAA operator at the controls [8]. Today, the NAA call letters are assigned to a station used for submarine communication that broadcasts from Cutler, Maine.



THROWING THE SWITCH THAT SENDS THE TIME SIGNAL TO AN ENTIRE NATION

Figure 2. NAA Time Signal Operator.

Another famous radio time signal began in 1924, the "six-pip" system of the British Broadcasting Corporation (BBC) in London.

The first 5 “pips” were audio tones that counted down the seconds to the sixth “pip”. Once known as the Greenwich Time Signal, the “pips” can still be heard on BBC programs today [9].

NIST (then called the National Bureau of Standards, or NBS) began experimental broadcasts from station WWV in Washington, DC in 1920, and began continuous operations in 1923. The station, now located in Fort Collins, Colorado, broadcasts time signals on 2.5, 5, 10, 15, and 20 MHz, and remains the world’s best known shortwave time signal. A similar station, WWVH, began operation in Hawaii in 1948. In its early days, WWV was used primarily as a frequency reference so that other radio broadcasters could calibrate their transmitters. Second markers were added to the broadcast in 1937, but a telegraphic time code was not added until 1945 [10].

The early stations sent time markers according to a known schedule, in some form of telegraphic code. For example, if a marker was sent at 10 a.m. Paris time, clocks could be synchronized to 10 a.m. when the marker was received. There was some sequence of coded signals that counted down to the time marker. Full digital time codes modulated on to a continuous wave carrier, and containing the hour, minute, second, and date did not appear until much later. In the United States, digital time codes began on WWV in 1960, on WWVH in 1971, and on WWVB in 1965.

2.1 Today’s Time Signal Broadcast Stations

Most of today’s RCCs receive signals located in a part of the radio spectrum called LF, which stands for low frequency. The LF spectrum covers the region from 30 to 300 kHz, but all of today’s time signal stations are found in the 40 to 80 kHz range. This the same part of the spectrum used by the very early time signal stations, such as FT and NAA. Low frequency is an appropriate name, and few devices other than RCCs now receive signals broadcast in this region. To put these frequencies into perspective, consider that everyday items such as FM radios and televisions receive frequencies that are thousands of times higher, and that cell phones, satellite TV receivers, and Global Positioning System (GPS) receivers are designed for frequencies that exceed 1 GHz.

Although LF communications isn’t exactly a modern technology, it remains perfectly suited for RCC applications, where only a small amount of information needs to be sent, and very little bandwidth is required. Sometimes called longwave stations (the 60 kHz wavelength is 5 km, or more than 3 miles), LF signals can cover a wide area with relatively low power and can be received indoors, since their signals can easily pass through non-metallic buildings and walls. This gives them an advantage for RCC applications over line-of-sight receivers that require an outdoor antenna, such as GPS.

Table 1 lists the time signal stations in the LF region that are most often used for RCC applications. All of the stations broadcast UTC time signals traceable to the national standard in their respective country. These stations broadcast digital time codes that contain the hour, minute, second, and date. The rightmost column in the table shows when the first digital time code became available, although several of these stations were on the air before then (for example, WWVB began as an experimental standard frequency station in 1956) [10]. And although each of the stations uses a different time code format, many RCCs now are designed to work with more than one station, since the carrier frequencies and modulation schemes are similar.

Table 1. LF Stations that Broadcast Radio Time Codes.

Call Letters	Country	Frequency (kHz)	Radiated Power (kW)	Time Code Modulation	First Time Code
WWVB	United States	60	50	A 10 dB power drop occurs at the start of each second. Full power is restored after 200 ms for a 0 bit, after 500 ms for a 1 bit, and after 800 ms for a frame marker.	1965
MSF	United Kingdom	60	15	The carrier is turned completely off at the start of each second for 100, 200, or 300 ms. Some seconds carry 2 bits of information.	1974
DCF77	Germany	77.5	30	A 12 dB power drop occurs at the start of each second. Full power is restored after 100 ms for a 0 bit, and after 200 ms for a 1 bit.	1973
JJY	Japan	40 and 60	12.5	The carrier amplitude is at full power at the start of each second. Power is dropped by 20 dB after 800 ms to signal a 0 bit, after 500 ms to signal a 1 bit, and after 200 ms to signal a frame marker.	1999 (60 kHz added in 2001)
BPC	China	68.5	NA	NA	2002

2.2 Manually operated radio controlled clocks

The first devices designed specifically to receive radio time signals required the operator to manually set a clock. The earliest products received time signals from sources such as the Eiffel Tower, which needed to be manually decoded. One early product was *The Horophone*, invented by Frank Hope-Jones (who later helped create the BBC “six-pip” system mentioned earlier), and offered for sale in 1913 by the Synchronome Company, Ltd. in London. An advertisement is shown in Figure 3 [11], and a photograph in Figure 4. The user of this product would listen to the time signals using headphones, and use a chart (such as the one shown in Figure 1) to decode the time signals and manually set a local clock. At least several other companies sold products of this type, including the company founded by Marconi.

Time Signals by Wireless

On and after July 1st the International Service of Time Signals will be transmitted according to — this spiral design. —

Cut it out for reference and get a

Horophone

A cheap and simple Receiving Outfit which will enable you to take — the Signals clearly. —

THE . . .

Synchronome Company, Limited.
32 & 34, CLERKENWELL ROAD, E.C.

Our neighbours in Clerkenwell are cordially invited to call and see our wireless receiving station in Synchronome House where the above instrument has been in daily use for two months.

2.2 Semi-automatic radio controlled clocks

There is no true consensus on who invented the first RCC that could synchronize to a wireless signal, and that could then continue to receive the signal to stay on time. Since there were digital time codes in the early days, it was not possible for a clock to automatically set itself; it needed a human operator to put it near the correct time prior to the arrival of a time marker. Once the marker was received, the clock would synchronize, and then regulate its frequency (and make time corrections) as further time markers were received. Before the advent of modern electronics, building such a device was a daunting task. Even so, it seems clear that semi-automatic RCCs clocks existed for decades before any were sold commercially.

Perhaps the first record of such a device came from London in 1912, when amazingly, F. O. Read of London claimed to have controlled a clock's time by wireless. An article in the *Daily Sketch* of October 4, 1912 (Figure 5) contained the following text:

Mr. F. O. Read, a Londoner, has nearly perfected his system by which it will be possible to control all our clocks and watches by wireless power. Mr. Read has already established a complete system of wireless clocks at his private residence, and is convinced that before very long the present day clocks, with their complicated mechanism, will be scrapped, and that all the timepieces of the world will be regulated from one centre [12].



Figure 4. The Horophone.



Figure 5. 1912 news story about F. O. Read.

Read went on to claim horological patents, but it is not known whether his wireless clock still exists or how it actually worked. Two other candidates for the inventor of the RCC are Marius Lavet and Alfred Ball. Lavet, a French horologist, worked on RCC designs throughout the 1920's (a sample design is in Figure 6), but apparently none went into production [13]. Lavet received many patents in the field of electrical timekeeping and became quite wealthy; he was eventually a key contributor to the development of the first quartz wrist watch. The English clockmaker Alfred Ball began experimenting with wireless control of electric clocks in 1914. He devoted the rest of his life to this research, which was incomplete when he died in 1932. He published a series of articles in the *Horological Journal* entitled "The Automatic Synchronisation of Clocks and Wireless Waves" from 1928 until his death [14]. Ball's work centered around the use of a master clock

Pul-Syn-Etic system which he had helped patent and invent. The *Pul-Syn-Etic* was a device that was used to synchronize the dials of other slave clocks. Ball designed an apparatus, consisting of a number of valves, relays and gears, that received the “6-pip” Greenwich time signal broadcast from Daventry, and used the impulses from the broadcast both to set the hands on time, and to regulate the speed of the pendulum. He wrote in 1928 that “the installation has operated without any attention whatever for the last six months, and the maximum error recorded has not exceeded one second fast or slow” [15]. There is no record that this



Figure 7. IBM Type 37 Clock.

system was ever sold commercially, but pre-production models with clock faces marked “Auto Controlled by Wireless from Daventry” were built [16].

In 1930, Roters and Paulding of the Stevens Institute of Technology in Hoboken, New Jersey published an account of an RCC designed to synchronize to signals from NAA, which was then broadcasting time markers on 112 kHz. The paper credits T. S. Casner of the *Radio Electric Clock Corporation* for the “broad work and many of the elements of the system”, so this clock was probably intended for production, but it is not known if any were sold. The receiver converted the NAA time signals sent between 11:55 a.m. and noon to current pulses used to drive the clock mechanism. The operator had to assist in the initial synchronization by turning the clock on and adjusting the display prior to the arrival of the time signal. However, after the clock was initially synchronized, a magnetic selector was used four times daily to detect the pulses, and make time corrections if necessary by adjusting the gears. The authors identified “static” as a problem, but noted that it was “almost impossible” to set the clock incorrectly, and that the maximum error would be 0.5 s [17].

The first semi-automatic RCC intended for consumer use in the United States with a NIST time signal might have been the *IBM Type 37 Radio Supervised Time Control Clock*, manufactured in 1956, designed for reception of the WWV/WWVH telegraphic time code (although it seems likely that other models were sold commercially or built for the military between 1945, when the telegraphic time code began, and 1956). Housed in a large wooden cabinet with a pendulum, it has the appearance of a grandfather

CORRECT TIME AUTOMATICALLY BY WIRELESS.

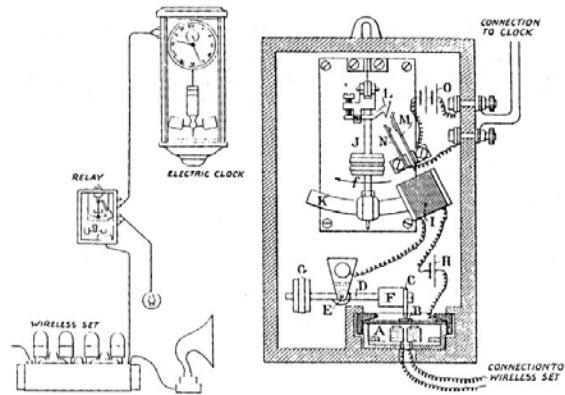

Figure 7B. The complete Lavet radio controlled clock mechanism.

Figure 6. One of Lavet's Early RCC Designs.

clock. One of these devices is on display at the NIST laboratories in Boulder, Colorado (Figure 7). A patent for a WWV/WWVH radio controlled clock was issued at about this same time to Theodore R. Gilliland, who had formerly worked for NBS. Gilliland received a patent in 1958 (applied for in 1956) entitled *Automatic Radio Control for Clocks* [18]. Gilliland's invention was an interesting combination of mechanical and electrical parts, and appears to be similar to the IBM design, but it is not known whether the two were related.

2.2 Automatic radio controlled clocks

Automatic RCCs that could “recover” time and date from the radio signal and synchronize their displays without any human interaction, first became possible in the United States when digital time codes appeared. Since WWV was the first NIST station to send a digital time code, it seems likely that the first product of this type was a WWV clock. A variety of WWV/WWVH RCCs appeared over the years, including even some gear driven analog wall clocks, but none were well suited for widespread consumer use. The receivers were more complex and larger than those inside the WWVB clocks that came later, and it was difficult to decode the time using an indoor antenna and a low-cost receiver. There was also the problem of choosing the best frequency to use for a given area, since the shortwave stations broadcast the same time code on multiple frequencies.

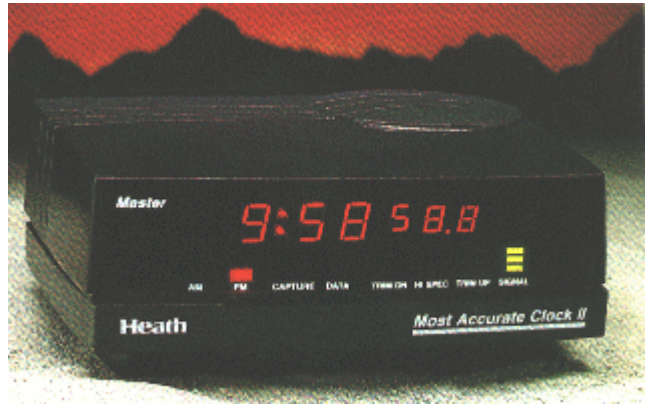

Figure 8. Heath "Most Accurate Clock"

Perhaps the most common example of a WWV/WWVH RCC was the *Heath GC-1000 Most Accurate Clock*, sold both in kit form and as an assembled product from about 1986 to 1995. This device, which looked similar to a digital clock radio (Figure 8), looked for the time code on three different frequencies (5, 10, and 15 MHz) and attracted a following among hobbyists. Even so, it was far more expensive (about \$400) and less likely to synchronize reliably than the WWVB products sold today.

Laboratory type receivers for the LF signals appeared in both the United States and Europe during the 1960s and 1970s, shortly after the first modern LF time codes originated (Table 1). There were also numerous articles written during this period for hobbyists about decoding LF time signals in magazines such as *Radio Electronics* and *Wireless World*, and some receivers were sold in kit form. However, the first consumer oriented RCCs that received LF radio signals are believed to be the *Kundo Space Timer* and the *Junghans RC-1*, both of which debuted around 1986 with analog only displays [19]. Various versions of these clocks were produced to receive both the DCF77 and MSF signals. The first radio controlled wrist watch is believed to be the *Junghans MEGA 1*, which debuted in 1990, an introduction that was hailed by one reviewer as “one of the most momentous horological events ever”. This digital watch synchronized to signals from station DCF77 in Germany [20]. Figure 9 shows the watch and its internal clockwork, including the antenna embedded inside the wrist band.



Figure 9. Junghans
MEGA 1

WWVB consumer oriented RCCs were relatively rare until 1999, when NIST increased the radiated output power of the station to 50 kW [21], a move that allowed the signal to reach all of the United States. Since then, the availability of WWVB products has continued to go up, the prices continue to go down, and the general public is gradually becoming aware that low cost clocks are available that always display the correct time. At this writing (April 2003), wall clocks are available for as little as \$10, and wrist watches for less than \$30. A collection of models is shown in Figure 10. The first products sold in the United States came primarily from Europe, modified versions of products originally designed to receive signals from DCF77 or MSF. Today, however, many products are designed specifically for the United States marketplace, and others are truly international products, capable of working with one or more stations.

The number of WWVB RCCs sold now numbers in the millions. Several timepiece manufacturers have projected that sales of RCCs will exceed 20 million units in 2003, with about 10% of these units sold to the United States marketplace for WWVB reception. This number is expected to reach 80 million units per year in 3 to 5 years, with approximately one-third of these sales designed for WWVB.



Figure 10. A collection of low-cost radio controlled clocks.

3. How WWVB Radio Controlled Clocks Work

The sole purpose of NIST radio station WWVB is to distribute time and frequency information from the national standard to the American public. The station continuously broadcasts a time code on a carrier frequency of 60 kHz at an effective radiated output power of 50 kW, which is strong enough to reach all 50 states.

A simplified block diagram of WWVB is shown in Figure 11. The 60 kHz carrier frequency is locked to the output of a cesium oscillator whose frequency is steered to agree with the national standard. A time code generator synchronized to UTC modulates the signal once per second by dropping the carrier power 10 dB (90%). If full power is restored 200 ms later, it represents a 0 bit. If full power is restored 500 ms later, it represents a 1 bit (Figure 12). A position marker is sent by dropping the power for 800 ms. Once the signal leaves the time code generators, it is sent to the transmitter, which amplifies the signal and broadcasts it using a large antenna array.

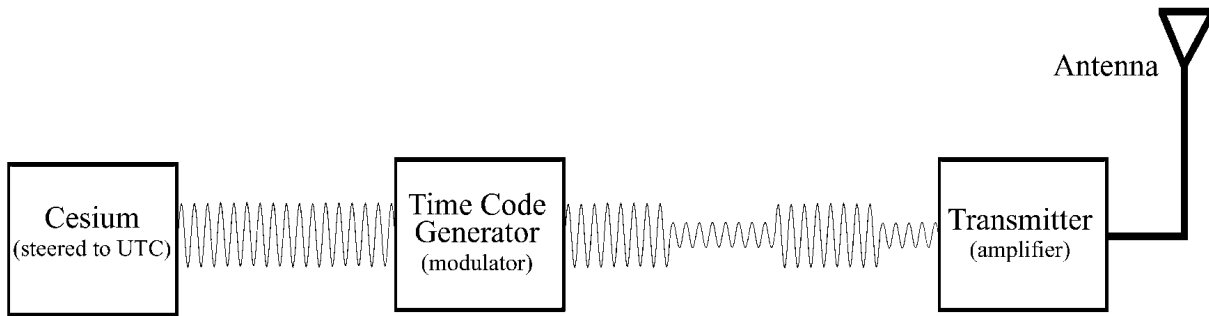

Figure 11. Simplified Block Diagram of NIST Radio Station WWVB.

Although this is a form of amplitude modulation, it is generally referred to as pulse width modulation by reduced carrier transmission. This is because the information contained in the signal is demodulated by looking at the pulse widths, and not by looking at the amplitude. The other LF time stations (Table 1) use variations of this technique to modulate the time code.

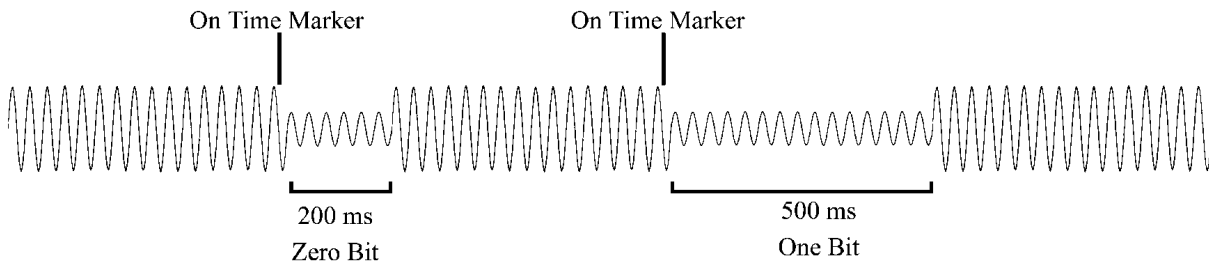

Figure 12. Pulse Width Modulation by Reduced Carrier Transmission.

In today's world of high speed communications, it's interesting to note that the WWVB code is sent at a very slow rate of 1 bit per second (imagine sending an email or fax at that speed), and it takes a full minute to send a complete time code. However, since the information is sent so slowly, it has the advantage of requiring very little bandwidth to transmit, and RCCs require very little processing power to decode the signal. Technically, the bandwidth requirement is just 5 Hz, but due to the nature of the transmission system the station has a bandwidth allocation of 2 kHz, of which several hundred hertz are currently used.

The time code contains time-of-day, date, and daylight saving time information (Figure 13). Since the time code takes a full minute to send, an RCC will probably miss the first time code when the clock is turned on, so it usually takes more than one minute to set itself. Since WWVB transmits UTC, the RCC applies a time zone correction to obtain local time. This time zone

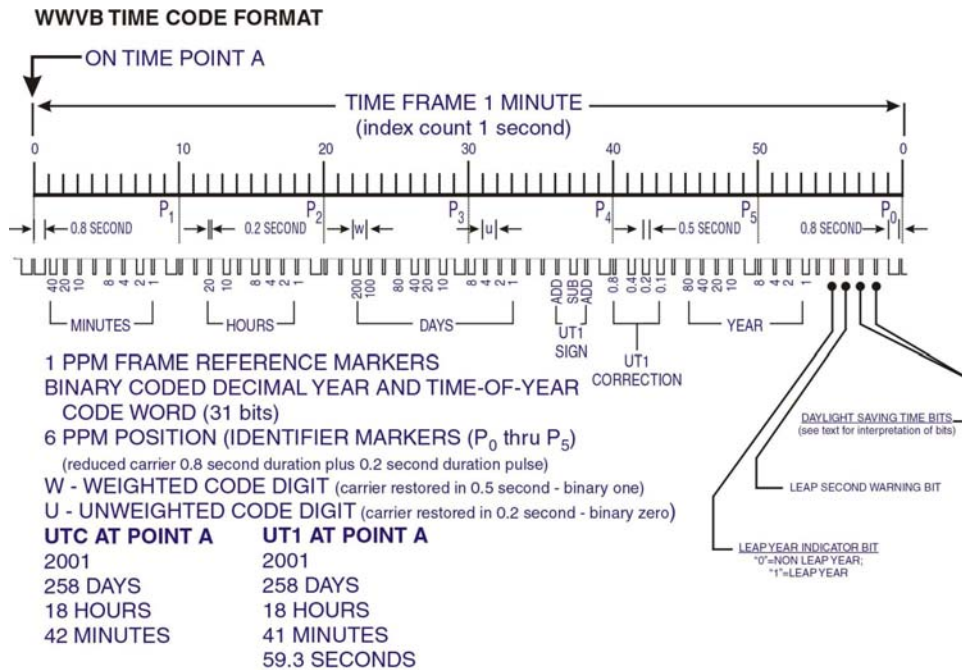

Figure 13. WWVB Time Code Format.

correction is set by the user, and needs to be changed if the RCC is moved to a different time zone.

Once an RCC has synchronized, it won't decode the signal from WWVB again for a while. Some clocks synchronize just once every 24 hours, usually at night, since the signal is stronger and easier to receive once the sun goes down. Between synchs, the RCC keeps time

using an internal quartz oscillator. Typically, the oscillator frequency is within a few parts per million of the correct frequency, which means it can keep time to within 1 second for a few days or more. Therefore, synching once per day makes the clock appear to be on the right second, even though it has likely gained or lost a fraction of a second since the last synchronization [10].

3.1 The internals of a LF Radio Controlled Clock

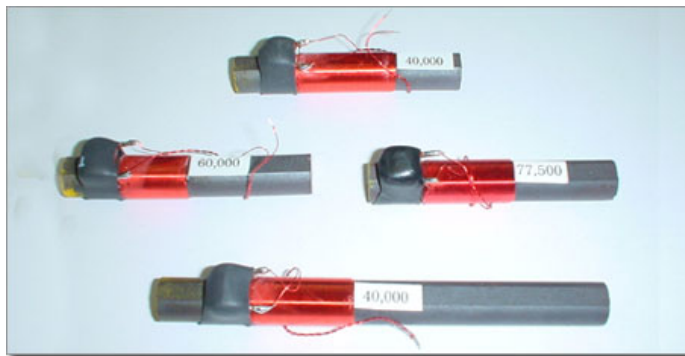

Figure 14. Antennas for various RCC frequencies.

Due to large scale production and advanced manufacturing techniques, it should soon cost just a few cents to add RCC capability to an existing quartz clock. However, one of the biggest challenges has been building miniature antennas that work with such long wavelength signals. One type of antenna often used in WWVB wall clock and desk clock designs is a ferrite loop, similar to those found inside an AM radio. This antenna consists of a ferrite bar wrapped with a coil of fine wire. The

length of wire and the way it is positioned and wrapped on the bar determine how well the antenna works. Figure 14 shows a variety of RCC antennas, designed for several of the stations listed in Table 1.

Digital signal processing circuits that use small amounts of space and power make it possible to manufacture receivers small enough to fit in an ordinary sized wristwatch. However, a radio controlled watch presents even a bigger challenge for the antenna designer, since the antenna must be inconspicuous and fit inside a very small space. Some wristwatches, particularly early models such as the one shown in Figure 9, placed the antenna inside the wrist band, but this meant that the band could be replaced only with another band of the same type. More recent designers place miniature antennas, often less than 20 mm wide, inside the watch itself as shown in Figure 15. In spite of these design challenges, some wristwatches now can receive signals from all or most of the stations listed in Table 1. This allows international travelers to get the correct time in most parts of the world, simply by changing the time zone setting on their watch.

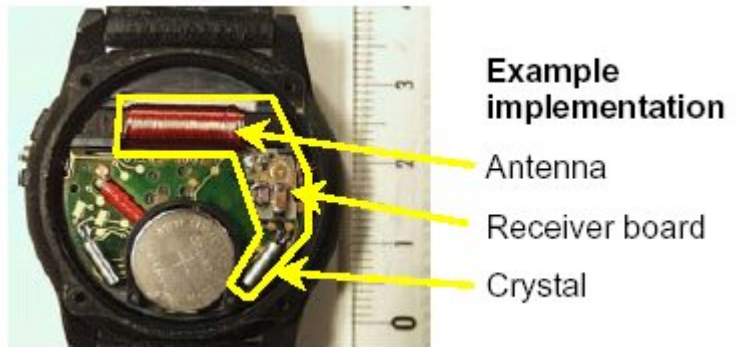

Figure 15. Inside a WWVB watch.

The RCCs that receive multiple LF transmitters have the internal processing ability to read multiple time codes, but still have to make do with a single antenna. When a different transmitter is selected, some designs match the antenna circuit to the antenna by varying the capacitance values, and generating a frequency near the desired carrier (for example, 60 kHz in the case of MSF or WWVB) from the receiver's local oscillator. However, since the size constraints make it difficult to build a narrow band antenna optimized for LF signals, the objective is simply to get as much of the signal as possible, and to use the local clock frequency to help pull the desired signal out of the noise. Some of the latest products are able to automatically select a time station by finding the strongest available signal, a feature that should become more common and useful if more LF time stations are built. It is still up to the user, however, to select the time zone.

4. Other Types of Radio Controlled Clocks

There are many types of clocks and time displays that are automatically synchronized via wireless signals, some of which you are probably not aware of, since the process is transparent. As this section describes, televisions, cell phones, and pagers are just a few of the devices that have built-in radio controlled clocks. There are no guarantees that these clocks will always be correct; however, most are referenced to either GPS or a NIST time and frequency broadcast.

4.1 Televisions

Most current models of televisions and videocassette recorders (VCR) have the ability to synchronize their clocks with time codes sent by the Public Broadcasting System (PBS). The time code is contained in the vertical blanking interval (VBI), or the first 21 horizontal lines of the 525-line analog video field that are not part of the visible picture. Based in part on work

begun by NIST (then called the National Bureau of Standards, or NBS) during the 1970's [22], the television networks began using line 21 of the VBI to send text messages for closed captioning, a service for the hearing impaired (NBS received an Emmy award for this work in 1980). By 1993, all television sets with displays of 33 cm (13 inches) and larger sold in the United States were required to have closed captioning capability, or the ability to decode line 21. Field 2 of line 21 is also used for the Extended Data Service (XDS), which includes a time code (Figure 16) containing UTC, the date, daylight saving time information, and a time zone offset [23]. Digital television (DTV) systems can carry more information than analog systems. However, the time code information is still provided, either on line 21 as before, or on a separate data stream defined by the DTV captioning standard [24].

	bit						
	6	5	4	3	2	1	0
Start of "Misc." packet	0	0	0	0	1	1	1
Type = Time-of-Day	0	0	0	0	0	0	1
Minute	1	m ₅	m ₄	m ₃	m ₂	m ₁	m ₀
Hour	1	D	H ₄	H ₃	H ₂	H ₁	H ₀
Date	1	L	D ₄	D ₃	D ₂	D ₁	D ₀
Month	1	Z	-	M ₃	M ₂	M ₁	M ₀
Weekday (1 = Sunday)	1	-	-	-	W ₂	W ₁	W ₀
Year (add 1990)	1	Y ₅	Y ₄	Y ₃	Y ₂	Y ₁	Y ₀
End of XDS packet	0	0	0	1	1	1	1

Figure 16. The XDS Line 21 Time Code for Television.

By mutual agreement within the broadcasting industry, the XDS time code is inserted by PBS stations only. TVs and VCRs use a feature (developed by PBS and the Sony Corporation), where each channel is scanned for a time code beginning with channel 2. Once a time code is found, the TV or VCR synchronizes its clock. Although this time code has been wrong in the past [25], PBS is currently working on a system to ensure that all of its stations broadcast a signal that is "frame accurate", or within 33.3 ms of UTC. Due to transmitting systems that can buffer several frames, the received uncertainty might still be as large as 100 ms. The time code is broadcast by over 160 PBS stations, and reaches well over 90% of the United States population.

4.2 GPS Clocks

The GPS signals broadcast via satellite by the United States Air Force are used worldwide both as a positioning tool with uncertainties of a few meters, and as a timekeeping tool with uncertainties measured in nanoseconds. The satellites carry on-board atomic clocks controlled by

the USNO. Despite their potentially unmatched accuracy, GPS RCCs are not common in the consumer marketplace because GPS signals are difficult to receive with indoor antennas. This is due to the line-of-sight nature of the signal (the sky must be visible to the antenna), and to the extremely low power level of the spread spectrum signal. However, a few GPS RCCs do exist, such as the wristwatch pictured in Figure 17. GPS watches are bulkier (due to the antenna size), and more expensive than their LF counterparts, but they provide more information than just the time, including your location, and the speed at which you are traveling.

Most consumer GPS products receive their time code on the L1 carrier at 1575.42 MHz. The information broadcast by GPS includes the number of weeks, the number of seconds, and the number of leap seconds since January 6, 1980, when the GPS time scale originated. Using this information, a GPS receiver can quickly compute UTC. Precise UTC is usually displayed by all GPS receivers, including the lowest cost handheld models. It is also possible (although not common in early products) for a GPS RCC with a geographical database to use the position information to identify the RCC's time zone, and to then automatically apply a time zone correction without asking the user to enter one.



Figure 17. GPS wristwatch.

An interesting new development in GPS technology is the addition of the L5 carrier at 1176.45 MHz, and the promise of a higher power L1 carrier on future satellites. Although it could be 2015 or later before the satellites have these new capabilities, they could make “indoor GPS” a reality, and eventually make GPS RCCs commonplace.

4.3 Cell Phones

The time displayed on your cellular telephone should be correct, at least when the phone is first turned on and has just synchronized to the signal. Cellular signals originate from Code Division Multiple Access (CDMA) base stations that operate in compliance with Telecommunications Industry Association (TIA/EIA) Standard IS-95 [26]. All base stations contain GPS receivers, and by definition, IS-95 time is GPS time. The base stations act as GPS repeaters by retransmitting the GPS time they receive from the satellites.

There are two types of IS-95 CDMA systems, distinguished by their frequency bands. The original analog cellular system, called the Advanced Mobile Phone System (AMPS), transmits base station signals (forward link signals) using frequencies from 869 to 894 MHz. The newer and more common Personal Communications Systems (PCS) band sends forward link signals in the 1930 to 1990 MHz range. Since the time and frequency information on either band is receive-only (no reverse link signals are sent), it is not necessary to subscribe to a telephone service to receive time signals. Therefore, a few radio controlled cellular clock products have appeared on

the market. These clocks should work anywhere a cell phone would work, and actually in some places where a cell phone will not work, since the forward link signal from the base station usually travels farther than the reverse link signal from a cell phone [27].

4.4 Car Radios

FM receivers can obtain time-of-day information from the Radio Data System (RDS) broadcast by many FM radio stations on a 57 kHz subcarrier. RDS is used to identify stations and radio programs, and automatically synchronizes the clocks on some car radios, clock radios, and communication receivers that already receive FM broadcasts. An estimated 15% of the approximately 5000 FM radio stations in the United States now utilize RDS. Every minute, the RDS sends a time code (Figure 18) containing the Modified Julian Date (MJD), the UTC hour and minute, and the local time zone offset [28]. RDS is also used for auto clock synchronization on some clock radios and communication receivers.

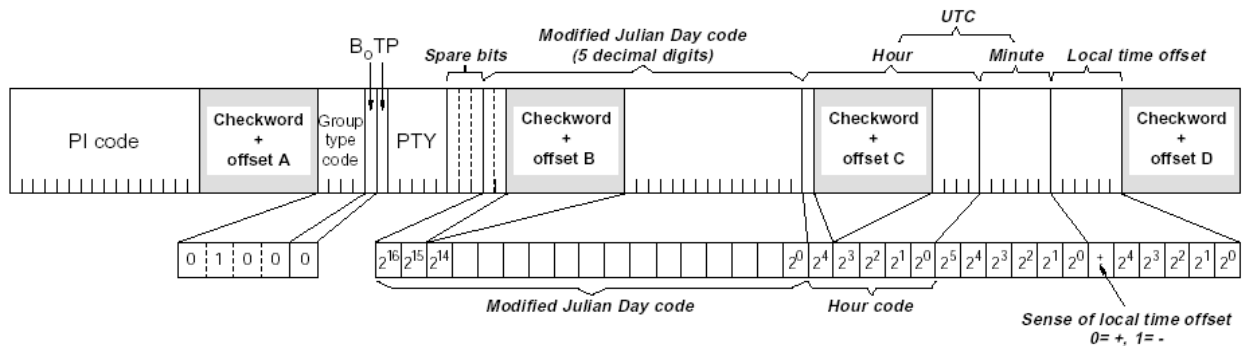

Figure 18. The RDS Time Code for FM Radio.

4.5 Pagers

Like cell phones, the time displayed on pagers is indirectly synchronized to GPS. Several wristwatches now sold in the United States automatically synchronize using the FLEX paging protocol developed by Motorola, and other paging protocols have also been used for clock synchronization. The FLEX time code is modulated on to a forward link frequency near 931 MHz. As with the cellular phone systems described earlier, it is not necessary to subscribe to a paging service to use the time code.

4.6 SPOT Technology Wristwatches

Wristwatches that utilize the Smart Personal Objects Technology (SPOT) developed by Microsoft and SCA Data Systems are expected to appear in late 2003. These devices will receive information such as stock prices, weather data, and sports scores. They also will receive a time code that will synchronize the watch, including a correction for the local time zone. The SPOT technology is similar to the Radio Data System described earlier; information is sent from existing FM radio stations on a 67 kHz subcarrier leased by Microsoft. The watches are initially expected to work in 100 large metropolitan areas covering all 50 states, plus in 13 metropolitan areas in Canada.

5. Summary

In today's world, most of us already either knowingly or unknowingly obtain the time from radio controlled clocks. Due to recent advances in technology, we appear to be moving quickly towards the day when nearly every clock display will be synchronized with an uncertainty of less than 1 second, and when the "exact time" is available to everyone.

This paper is a contribution of the United States Government, and is not subject to copyright.

Identification of commercial products and companies is done for the purposes of illustration and description only, and to provide historical background. It neither implies nor constitutes endorsement by NIST.

References

1. A. V. Simcock, "Sir Howard Grubb's proposals for radio control of clocks and watches", *Radio Time*, vol. 4, issue 10, Autumn 1992, pp. 18-22.
2. Sir H. Grubb, "Proposal for the Utilisation of the 'Marconi' System of Wireless Telegraphy for the Control of Public and Other Clocks", *Scientific Proceedings for the Royal Dublin Society*, vol. X, part I, no. 7, 1899, pp. 46-49.
3. T. Jones, *Splitting the Second: The Story of Atomic Time*, Institute of Physics Publishing, United Kingdom, 2000, p. 121.
4. G. A. Weber, *The Naval Observatory: Its History, Activities, and Organization*, John Hopkins Press, Baltimore, 1926, p. 35.
5. D.L. Hutchinson, "Wireless Time Signals from the St. John Observatory of the Canadian Meteorological Service," *Proceedings and Transactions of the Royal Society of Canada*, Section III, 3rd Series, vol. 2, 1908, p. 153.
6. C. Aked, "Le Temps Telegraphique San Fils Francais", *Radio Time*, vol. 5, issue 14, Spring 1994, pp. 77-86.
7. J. L. Jayne, "The Naval Observatory Time Service and how Jewelers may make use of its Radio Signals", *The Horological Journal*, vol. 56, October, November, December 1913.
8. A. H. Orme, "Regulating 10,000 Clocks by Wireless", *Technical World Magazine*, October 1913, pp. 22-233.
9. *Splitting the Second: The Story of Atomic Time*, pp. 138-139.
10. M. A. Lombardi, "NIST Time and Frequency Services", *NIST Special Publication 432*, 71 pages, January 2002 (available on-line at <http://tf.nist.gov>).

11. D. J. Boullin, "History of Radio-Controlled Clocks", *Radio Time*, vol. 1, issue 1, August 1989, pp. 15-19.
12. D. J. Boullin, "Read's Radio Controlled Clock of 1912", *Radio Time*, vol. 3, issue 8, Spring 1992, pp. 30-33.
13. E. Hanson, "Early Radio Time Control Systems", *Radio Time*, vol. 1, issue 3, Spring 1990, pp. 24-26.
14. D. J. Bird, "The Earliest Radio Controlled Clocks", *Radio Time*, vol. 1, issue 2, Autumn/Winter 1989, pp. 20-22.
15. D. J. Boullin, "The Radio Controlled Clock of Alfred E. Ball, 1928", *Radio Time*, vol. 6, issue 16, Autumn/Winter 1994/1995, pp. 22-23.
16. D. J. Boullin, "Alfred Ball's 'Pul-Syn-Etic' Slave Clock, Auto Controlled by Wireless from Daventry, 1928", *Radio Time*, vol. 7, issue 21, Summer/Autumn 1996, pp. 111-113.
17. H. C. Roters, H. L. Paulding, "Radio Electric Clock System", *Proceedings of the Institute of Radio Engineers*, vol. 18, no. 9, September 1930, pp. 1537-1559.
18. T. R. Gilliland, "Automatic Radio Control for Clocks", *United States Patent 2,824,218* (application date May 22, 1956, received February 18, 1958).
19. D. J. Boullin, "The First Domestic Radio-Controlled Clocks", *Radio Time*, vol. 1, issue 1, August 1989, pp. 12-13.
20. D. J. Boullin, "The Junghans Radio Controlled Watch", *Radio Time*, vol. 1, issue 3, Spring 1990, pp. 3-7.
21. M. Deutch, D. W. Hanson, G. Nelson, C. Snider, D. Sutton, W. Yates, P. M. Hansen, B. Hopkins, "WWVB Improvements: New Power From An Old Timer", *Proc. Precise Time and Time Interval Meeting (PTTI)*, December 1999, pp. 523-535. (available on-line at: <http://tf.nist.gov>)
22. D. D. Davis, B. E. Blair, J. F. Barnaba, "Long-term continental U. S. timing system via television networks", *IEEE Spectrum*, vol. 8, No. 8, pp. 41-52, August 1971.
23. Electronics Industry Association, "Line 21 Data Service", *EIA-608-B*, 113 pages, October 2000.
24. Electronics Industry Association, "Digital Television DTV Closed Captioning", *EIA-708-B*, 97 pages, December 1999.
25. T.S. Perry, "Does Anybody Really Know What Time It Is?" *IEEE Spectrum*, vol. 37, no. 10, October 2000, pp. 26-28.

26. “Mobile Station-Base Station Compatibility Standard for Wideband Spread Spectrum Cellular Systems,” *TIA/EIA Standard 95-B*, Arlington, VA: Telecommunications Industry Association, March 1999.
27. B. M. Penrod, “A New Class of Precision UTC and Frequency Reference Using IS-95 CDMA Base Station Transmissions”, *Proceedings of the 33rd Annual Precise Time and Time Interval Meeting (PTTI)*, December 2001.
28. National Radio Systems Committee, *Specification of the Radio Broadcast Data System (RBDS)*, 204 pages, April 1998.