

VSI OpenVMS

Linker Utility Manual

Document Number: DO-DLKRRM-01A

Publication Date: August 2019

This manual describes the OpenVMS Linker utility. The linker creates images containing binary code and data that run on OpenVMS x86-64, OpenVMS I64, OpenVMS Alpha, or OpenVMS VAX systems. These images are primarily executable images activated at the DCL command line. The linker also creates shareable images that can be called by executable or by other shareable images.

Revision Update Information: This is a new manual.

Operating System and Version: VSI OpenVMS x86-64 Version 9.0
VSI OpenVMS I64 Version 8.4-1H1
VSI OpenVMS Alpha 8.4-2L1

Linker Utility Manual:



Copyright © 2019 VMS Software, Inc. (VSI), Bolton, Massachusetts, USA

Legal Notice

Confidential computer software. Valid license from VSI required for possession, use or copying. Consistent with FAR 12.211 and 12.212, Commercial Computer Software, Computer Software Documentation, and Technical Data for Commercial Items are licensed to the U.S. Government under vendor's standard commercial license.

The information contained herein is subject to change without notice. The only warranties for VSI products and services are set forth in the express warranty statements accompanying such products and services. Nothing herein should be construed as constituting an additional warranty. VSI shall not be liable for technical or editorial errors or omissions contained herein.

HPE, HPE Integrity, HPE Alpha, and HPE Proliant are trademarks or registered trademarks of Hewlett Packard Enterprise.

Intel, Itanium, and IA-64 are trademarks or registered trademarks of Intel Corporation or its subsidiaries in the United States and other countries.

UNIX is a registered trademark of The Open Group.

The VSI OpenVMS documentation set is available on DVD.

Preface	ix
1. About VSI	ix
2. Intended Audience	ix
3. Document Structure	ix
4. Related Documents	x
5. VSI Encourages Your Comments	x
6. How to Order Additional Documentation	x
7. Typographical Conventions	x
Chapter 1. Introduction	1
1.1. Overview	1
1.1.1. Terminology Used in this Manual	1
1.1.2. Linker Overview	2
1.1.3. Linker Functions	4
1.1.4. Using the Linker	4
1.2. Specifying Input to the Linker	6
1.2.1. Object Modules as Linker Input Files	7
1.2.2. Shareable Images as Linker Input Files	7
1.2.2.1. Including a Shareable Image in a Link Operation	8
1.2.2.2. Installing a Shareable Image	9
1.2.3. Library Files as Linker Input Files	9
1.2.3.1. Creating a Library File	9
1.2.3.2. Including a Library File in a Link Operation	10
1.2.4. Symbol Table Files as Linker Input Files (VAX Only)	11
1.2.5. Options Files as Linker Input Files	11
1.3. Specifying Linker Output Files	13
1.3.1. Creating an Executable Image	14
1.3.2. Creating a Shareable Image	14
1.3.3. Creating a System Image (Alpha and VAX)	14
1.3.4. Creating a Symbol Table File	15
1.3.5. Creating a Map File	15
1.3.6. Creating a Debug Symbol File (64-Bit Systems)	16
1.4. Controlling a Link Operation	16
1.4.1. Linker Qualifiers	16
1.4.2. Link Options	19
1.5. Linking for Different Architectures (Alpha and VAX)	21
Chapter 2. Understanding Symbol Resolution (x86-64 and I64)	23
2.1. Overview	23
2.1.1. Types of Symbols	23
2.1.1.1. Understanding Strong and Weak Symbols	24
2.1.1.2. Group Symbols	24
2.1.1.3. The C Extern Common Model	24
2.1.1.4. Tentative Definitions in C	25
2.1.1.5. Considerations for C Language Extensions	25
2.1.2. Linker Symbol Resolution Processing	25
2.2. Input File Processing for Symbol Resolution	29
2.2.1. Processing Object Modules	30
2.2.2. Processing Shareable Images	32
2.2.2.1. Implicit Processing of Shareable Images	34
2.2.3. Processing Library Files	34
2.2.3.1. Identifying Library Files Using the /LIBRARY Qualifier	35

2.2.3.2. Including Specific Modules from a Library Using the /INCLUDE Qualifier	36
2.2.3.3. Processing Default Libraries	36
2.2.4. Processing Input Files Selectively	37
2.3. Ensuring Correct Symbol Resolution	38
2.3.1. Understanding Cluster Creation	38
2.3.2. Controlling Cluster Creation	40
2.3.2.1. Using the CLUSTER= Option to Control Clustering	40
2.3.2.2. Using the COLLECT= Option to Control Clustering	40
2.4. Resolving Symbols Defined in the OpenVMS Executive	41
2.5. Processing Weak and Strong Global Symbols	42
2.5.1. Overview of Weak and Strong Global Symbol Processing	42
2.5.1.1. Strong Symbols	43
2.5.1.2. VMS-Style Weak Symbols	43
2.5.1.3. UNIX-Style Weak Symbols	43
2.5.2. Strong and Weak Definitions	43
2.5.3. Resolving Strong and Weak Symbols	44
2.5.4. Creating and Using VMS-style Weak Symbols	45
2.6. Processing VSI C++ Compiler-Generated UNIX-Style Weak and Group Symbols	45
2.6.1. Processing Group Symbols	45
2.6.2. VSI C++ Examples	46
2.6.3. Compiler-Generated Symbols and Shareable Images	48
2.7. Understanding and Fixing DIFTYPE and RELODIFTYPE Linker Conditions (I64 Only)	48
Chapter 3. Understanding Image File Creation (x86-64 and I64)	51
3.1. Overview	51
3.2. Creating Sections	52
3.2.1. Sections Created by The Linker	60
3.2.1.1. Sections for Relaxed Symbol Definitions	60
3.2.1.2. Sections Embedded in Code Segments (I64 Only)	60
3.2.1.3. Short Data Sections (I64 Only)	62
3.2.1.4. Section for the Symbol Vector	63
3.2.1.5. Sections that Contain Unwind Data (I64 Only)	64
3.3. Creating Segments	64
3.3.1. Processing Clusters to Create Segments	65
3.3.2. Combining Sections into Image Segments	65
3.3.3. Traditional OpenVMS Image Attribute Terms and ELF Terms	67
3.3.4. Processing Significant Section Attributes	67
3.3.5. Allocating Memory for Segments	72
3.3.6. Segment Attributes	73
3.3.7. Controlling Segment Creation	75
3.3.7.1. Modifying Section Attributes	75
3.3.7.2. Alternate Way to Modify Section Attributes	76
3.3.7.3. Manipulating Cluster Creation	77
3.3.7.4. Isolating a Section into a Segment	77
3.4. Initializing an Image on x86-64 and I64 Systems	78
3.4.1. Handling of Initialized Overlaid Sections	78
3.4.2. Writing the Binary Contents of Segments	79
3.4.3. Other Image Segments	80
3.4.3.1. Global Offset Table Segments (x86-64 Only)	80
3.4.3.2. Unwind Segments (I64 Only)	80
3.4.3.3. Short Data Segment (I64 Only)	80

3.4.3.4. Signature Segment (I64 Only)	80
3.4.3.5. Dynamic Segment	81
3.4.4. Keeping the Size of Image Files Manageable	83
3.4.4.1. Controlling Demand-Zero Image Segment Creation	84
3.4.5. Creating ELF Sections in the Image File	84
3.4.6. Writing the Main Output Files	85
Chapter 4. Creating Shareable Images (x86-64 and I64)	87
4.1. Overview of Creating Shareable Images on x86-64 and I64 Systems	87
4.2. Declaring Universal Symbols in x86-64 and I64 Shareable Images	88
4.2.1. Symbol Definitions Point to Shareable Image Sections	92
4.2.2. Creating Upwardly Compatible Shareable Images	93
4.2.3. Deleting Universal Symbols Without Disturbing Upward Compatibility	94
4.2.4. Creating Run-Time Kits	94
4.2.5. Specifying an Alias Name for a Universal Symbol	95
4.3. Improving the Performance of Installed Shareable Images	95
4.4. Linking User-Written System Services	96
Chapter 5. Interpreting an Image Map File (x86-64 and I64)	97
5.1. Overview of x86-64/I64 Linker Map	97
5.2. Components of an x86-64/I64 Image Map File	98
5.2.1. Object and Image Synopsis Section	99
5.2.2. Cluster Synopsis Section	101
5.2.3. Image Segment Synopsis Section	102
5.2.4. Program Section Synopsis Section	104
5.2.5. Symbol Cross-Reference Section	105
5.2.6. Symbols By Value Section	106
5.2.7. Image Synopsis Section	107
5.2.8. Link Run Statistics Section	108
5.3. Shortened Names with Footnotes in the Cross-Reference	109
5.4. Translation Table for Mangled Names	110
Chapter 6. Understanding Symbol Resolution (Alpha and VAX)	113
6.1. Overview	113
6.1.1. Types of Symbols	113
6.1.2. Linker Symbol Resolution Processing	114
6.2. Input File Processing for Symbol Resolution	117
6.2.1. Processing Object Modules	118
6.2.2. Processing Shareable Images	120
6.2.3. Processing Library Files	122
6.2.3.1. Identifying Library Files Using the /LIBRARY Qualifier	122
6.2.3.2. Including Specific Modules from a Library Using the /INCLUDE Qualifier	123
6.2.3.3. Processing Default Libraries	124
6.2.3.4. Open Systems Library Support	124
6.2.4. Processing Input Files Selectively	125
6.3. Ensuring Correct Symbol Resolution	126
6.3.1. Understanding Cluster Creation	126
6.3.2. Controlling Cluster Creation	127
6.3.2.1. Using the CLUSTER= Option to Control Clustering	127
6.3.2.2. Using the COLLECT= Option to Control Clustering	128
6.4. Resolving Symbols Defined in the OpenVMS Executive	128
6.5. Defining Weak and Strong Global Symbols	129

Chapter 7. Understanding Image File Creation (Alpha and VAX)	131
7.1. Overview of Creating Images on Alpha/VAX Systems	131
7.2. Creating Program Sections (Alpha/VAX)	132
7.3. Creating Image Sections	138
7.3.1. Processing Clusters to Create Image Sections	139
7.3.2. Combining Program Sections into Image Sections	140
7.3.3. Processing Significant Program Section Attributes (Alpha/VAX)	141
7.3.4. Allocating Memory for Image Sections	146
7.3.5. Image Section Attributes	147
7.3.6. Controlling Image Section Creation	151
7.3.6.1. Modifying Program Section Attributes	151
7.3.6.2. Manipulating Cluster Creation	151
7.3.6.3. Isolating a Program Section into an Image Section	152
7.4. Initializing an Image on Alpha/VAX Systems	152
7.4.1. Writing the Binary Contents of Image Sections	152
7.4.2. Fixing Up Addresses	153
7.4.3. Keeping the Size of Image Files Manageable	154
7.4.3.1. Controlling Demand-Zero Image Section Creation	154
Chapter 8. Creating Shareable Images (Alpha and VAX)	155
8.1. Overview of Creating Shareable Images on Alpha/VAX Systems	155
8.2. Declaring Universal Symbols in VAX Shareable Images	156
8.2.1. Creating Upwardly Compatible Shareable Images (VAX Only)	158
8.2.1.1. Creating a Transfer Vector (VAX Only)	159
8.2.1.2. Fixing the Location of the Transfer Vector in Your Image (VAX Only)	161
8.2.2. Creating Based Shareable Images (VAX Linking Only)	161
8.3. Declaring Universal Symbols in Alpha Shareable Images	161
8.3.1. Symbol Definitions Point to Shareable Image Psects (Alpha Only)	163
8.3.2. Creating Upwardly Compatible Shareable Images (Alpha Only)	164
8.3.3. Deleting Universal Symbols Without Disturbing Upward Compatibility (Alpha Only)	164
8.3.4. Creating Run-Time Kits (Alpha Only)	165
8.3.5. Specifying an Alias Name for a Universal Symbol (Alpha Only)	165
8.3.6. Improving the Performance of Installed Shareable Images (Alpha Only)	165
Chapter 9. Interpreting an Image Map File (Alpha and VAX)	167
9.1. Overview of Alpha/VAX Linker Map	167
9.2. Components of an Image Map File (Alpha/VAX)	168
9.2.1. Object Module Synopsis (Alpha/VAX)	169
9.2.2. Module Relocatable Reference Synopsis (VAX Only)	169
9.2.3. Image Section Synopsis Section (Alpha/VAX)	170
9.2.4. Program Section Synopsis Section (Alpha/VAX)	172
9.2.5. Symbols By Name Section (Alpha/VAX)	173
9.2.6. Symbol Cross-Reference Section (Alpha/VAX)	174
9.2.7. Symbols By Value Section (Alpha/VAX)	174
9.2.8. Image Synopsis Section (Alpha/VAX)	175
9.2.9. Link Run Statistics Section (Alpha/VAX)	175
Chapter 10. LINK Command Reference	177
10.1. LINK Command	177
10.2. Qualifier Descriptions	178
10.3. Option Descriptions	213

Glossary 239

Preface



1. About VSI

VMS Software, Inc. (VSI) is an independent software company licensed by Hewlett Packard Enterprise to develop and support the OpenVMS operating system.

VSI seeks to continue the legendary development prowess and customer-first priorities that are so closely associated with the OpenVMS operating system and its original author, Digital Equipment Corporation.

2. Intended Audience

Programmers at all levels of experience can use this manual effectively.

3. Document Structure

This book is organized as follows:

Chapter 1 introduces the OpenVMS Linker utility and how to use the LINK command and its qualifiers and parameters.

Chapter 2 describes how the linker resolves symbolic references among input files on x86-64 and I64 systems.

Chapter 3 describes how the linker creates image files on x86-64 and I64 systems.

Chapter 4 describes how to create shareable images and use them in link operations on x86-64 and I64 systems.

Chapter 5 describes how to interpret linker image maps on x86-64 and I64 systems.

Chapter 6 describes how the linker resolves symbolic references among input files on Alpha and VAX systems.

Chapter 7 describes how the linker creates image files on Alpha and VAX systems.

Chapter 8 describes how to create shareable images and use them in link operations on Alpha and VAX systems.

Chapter 9 describes how to interpret linker image maps on Alpha and VAX systems.

Chapter 10 provides reference information that describes the LINK command and its qualifiers and options.

The Glossary contains a list of important terms to refer to hardware and/or software entities, for the OpenVMS Linker running on a variety of OpenVMS operating systems and computers.

4. Related Documents

The following manuals contain related information.

For architecture-specific information, see:

- *VAX Architecture Handbook, Digital Equipment Corporation, 1987*
- *Alpha Architecture Handbook, Digital Equipment Corporation, 1996*
- *Intel® Itanium® Architecture Software Developer's Manual, Intel Corporation, 2010*
- *Intel® 64 and IA-32 Architectures Software Developer Manuals, Intel Corporation, 2019*

For information about run-time conventions, see the *VSI OpenVMS Calling Standard*.

For information on including the debugger in the linking operation and about debugging in general, see the *VSI OpenVMS Debugger Manual*.

5. VSI Encourages Your Comments

You may send comments or suggestions regarding this manual or any VSI document by sending electronic mail to the following Internet address: <docinfo@vmssoftware.com>.

6. How to Order Additional Documentation

For information about how to order additional documentation, email the VSI OpenVMS information account: <info@vmssoftware.com>. We will be posting links to documentation on our corporate website soon.

7. Typographical Conventions

The following conventions are used in this manual:

Convention	Meaning
Ctrl/x	A sequence such as Ctrl/x indicates that you must hold down the key labeled Ctrl while you press another key or a pointing device button.
PF1 x	A sequence such as PF1 x indicates that you must first press and release the key labeled PF1 and then press and release another key (x) or a pointing device button.
...	A horizontal ellipsis in examples indicates one of the following possibilities: <ul style="list-style-type: none"> • Additional optional arguments in a statement have been omitted. • The preceding item or items can be repeated one or more times. • Additional parameters, values, or other information can be entered.
. .	A vertical ellipsis indicates the omission of items from a code example or command format; the items are omitted because they are not important to the topic being discussed.

Convention	Meaning
()	In command format descriptions, parentheses indicate that you must enclose choices in parentheses if you specify more than one.
[]	In command format descriptions, brackets indicate optional choices. You can choose one or more items or no items. Do not type the brackets on the command line. However, you must include the brackets in the syntax for directory specifications and for a substring specification in an assignment statement.
	In command format descriptions, vertical bars separate choices within brackets or braces. Within brackets, the choices are optional; within braces, at least one choice is required. Do not type the vertical bars on the command line.
{ }	In command format descriptions, braces indicate required choices; you must choose at least one of the items listed. Do not type the braces on the command line.
bold type	Bold type represents the name of an argument, an attribute, or a reason. Bold type also represents the introduction of a new term.
<i>italic type</i>	Italic type indicates important information, complete titles of manuals, or variables. Variables include information that varies in system output (Internal error <i>number</i>), in command lines (<i>/PRODUCER=name</i>), and in command parameters in text (where <i>dd</i> represents the predefined code for the device type).
UPPERCASE TYPE	Uppercase type indicates a command, the name of a routine, the name of a file, or the abbreviation for a system privilege.
Example	This typeface indicates code examples, command examples, and interactive screen displays. In text, this type also identifies website addresses, UNIX command and pathnames, PC-based commands and folders, and certain elements of the C programming language.
-	A hyphen at the end of a command format description, command line, or code line indicates that the command or statement continues on the following line.
numbers	All numbers in text are assumed to be decimal unless otherwise noted. Nondecimal radices—binary, octal, or hexadecimal—are explicitly indicated.

Chapter 1. Introduction

This chapter introduces the OpenVMS Linker utility (the linker), describing its primary functions and its role in software development. The chapter describes the following:

- Definition of the linker and its main functions
- How to invoke the linker
- How to specify input files in a link operation
- How to specify which output files the linker produces

In addition, this chapter provides an overview of how you can control a link operation by using qualifiers and options.

1.1. Overview

This section provides a list of key terms used in this manual and an overview of the OpenVMS Linker.

1.1.1. Terminology Used in this Manual

The OpenVMS Linker utility runs on a variety of OpenVMS operating systems and computers. Several important terms are used in this manual to refer to these hardware and/or software entities. The following list defines these terms. For a complete list of linker terminology, see the Glossary.

- system — The computer hardware, the server; distinguish from the operating system (for example, OpenVMS Alpha).
- platform — The system architecture; includes all systems running (for example, Intel® Itanium® processors).
- OpenVMS system — An operating system that runs on multiple platforms including x86-64, I64, Alpha, and VAX.
- OpenVMS x86-64 system (or x86-64 system) — A server running the OpenVMS x86-64 operating environment.
- OpenVMS I64 system (or I64 system) — An HPE Integrity server running the OpenVMS I64 operating environment.
- OpenVMS Alpha system (or Alpha system) — An HPE Alpha system running the OpenVMS Alpha operating system.

OpenVMS x86-64, OpenVMS I64, and OpenVMS Alpha systems are collectively referred to as the 64-bit systems.

- OpenVMS VAX system (or a VAX system) — An HPE VAX system running the OpenVMS VAX operating system.
- Executable and Linkable Format (ELF) — The object and image format described in the *System V Application Binary Interface*. See the Glossary for a complete definition of this term and additional terms.

x86-64, I64, Alpha, or VAX might be used as prefixes as well. For example:

- x86-64 linking — The process of using the OpenVMS Linker utility to create an OpenVMS x86-64 image.
- I64 image — An OpenVMS I64 image that includes binary data and Itanium instructions.
- Alpha object file — An OpenVMS Alpha object that includes binary data and Alpha instructions.

1.1.2. Linker Overview

The primary purpose of the linker is to create images. An **image** is a file containing binary code and data that can be executed on an OpenVMS system.

On OpenVMS x86-64 and OpenVMS I64 systems, the linker creates only native images—x86-64 images on x86-64 systems, I64 images on I64 systems.

On OpenVMS Alpha and OpenVMS VAX systems, the linker creates native images by default.

On both OpenVMS Alpha and OpenVMS VAX systems, the linker supports `/ALPHA` and `/VAX` qualifiers that allow you to instruct the linker to accept Alpha or VAX object files on each respective system (see information about these linker qualifiers in Chapter 10). As a result, the linker can create VAX images on an Alpha system, and vice versa.

The primary type of image the linker creates is an **executable image**. An executable image can be activated at the DCL command line by issuing the `RUN` command. At run-time, the **image activator**, which is part of the operating system, opens the image file and reads activation information from the image to set up process page tables and pass control to the location (transfer address) where image execution is to begin.

The linker can also create a **shareable image**. A shareable image is a collection of procedures and data that can be called by executable images or by other shareable images. A shareable image is similar to an executable image. The linker separates shareable from nonshareable code and data. Shareable code and data can be shared via global sections that are set up by the `Install` utility or by the image activator.

To use the procedures or data of a shareable image, the shareable image has to be included in a link operation for another image, either explicitly in a linker option or implicitly from a default shareable image library. At run-time, when the image activator processes an executable image, it activates all the shareable images to which the executable image was linked.

The OpenVMS Alpha and OpenVMS VAX linkers can also create a **system image**, which can be run as a standalone system. System images generally do not contain image activation information and are not activated by the image activator. Images without activation information are not defined in the OpenVMS x86-64 and I64 object languages. As a result, the OpenVMS x86-64 and OpenVMS I64 linkers do not create this special type of image.

The linker creates images by processing the input files you specify. The primary type of input file that can be specified in a link operation is an **object file**. Object files that contain one or more object modules are produced by language processors, such as compilers or assemblers.

The binary code and data in an object module is in a platform-specific format:

- On x86-64 and I64 platforms, the object module (and the resulting image) is in the Executable and Linkable Format (ELF).

- On Alpha platforms, the object module is in the Alpha Object Language format.
- On VAX platforms, the object module is in the VAX Object Language format.

Note

This manual frequently refers to parts of the format of the object language. As such, different terminology is occasionally used when referring to the same item on different platforms.

For example, on OpenVMS Alpha and VAX systems, the linker collects *program sections* (generally called psects) into *image sections*. Comparatively, on OpenVMS x86-64 and I64 systems the linker collects *sections* into *segments*. Although the names appear similar, there are considerable differences between the structure and content of an image section on OpenVMS Alpha and VAX compared with a segment on OpenVMS x86-64 and I64.

OpenVMS I64 compilers also take advantage of a short data section when constructing code with offsets from the global pointer (GP) register, neither of which are present on OpenVMS Alpha and VAX.

When the manual refers to a specific part of the object language, distinctions are made as to whether the reference pertains to the object language used by OpenVMS x86-64, I64, Alpha, or VAX.

The linker also accepts other input files such as shareable images, and on VAX platforms, symbol table files, which are both products of previous link operations. Section 1.2 provides more information about all the types of input files accepted by the linker. Section 1.3 provides more information about the output files created by the linker.

Figure 1.1 illustrates the relationship of the linker to the language processor in the program development process.

Figure 1.1. Position of the Linker in Program Development

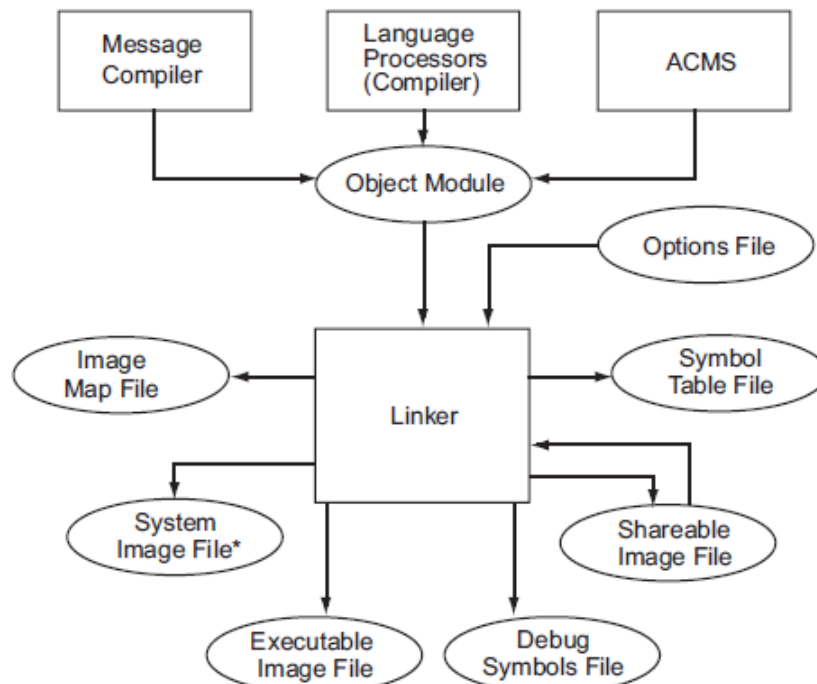

* OpenVMS Alpha and VAX only

ZK-5070A-AI

1.1.3. Linker Functions

To create an image from the input files you specify, the linker performs the following primary functions:

- **Symbol resolution.** Source modules can use symbols to represent the location of a routine entry point, the location of a data item, or a constant value. A source module may reference symbols that are defined externally to the module. When a language processor, such as a compiler or assembler, processes the source module, it cannot find the value of a symbol defined externally to the module. A language processor flags these externally defined symbols as unresolved symbolic references and leaves it to the linker to find their definitions among the other input files you specify. When the linker finds the definition of a symbol, it substitutes the value of the symbol (its definition) for the reference to the symbol. Chapter 2 (x86-64 and I64) and Chapter 6 (Alpha and VAX) provide more information about symbol resolution.
- **Virtual memory allocation.** After resolving symbolic references among the input files, the linker allocates virtual memory for the image, based on the memory requirements specified by the input files. Chapter 3 (x86-64 and I64) and Chapter 7 (Alpha and VAX) provide more information about memory allocation.
- **Image initialization.** After the linker resolves references and obtains the memory requirements of the image, it initializes the image by filling it with the compiled binary data and code. The linker also inserts the actual value of resolved symbols at each instance where the symbol is referenced.

For certain global symbols, the linker does not write their value into the image. For example, when taken from shareable images, the value of a symbol that represents an address cannot be determined until run-time; that is, when the image activator loads the image into memory. The linker lists these symbols in the fix-up information, to which the image activator provides the actual address at run-time.

When the image activator loads a shareable image in memory and relocates all the symbols in the shareable image, it must ensure that the other images that reference these symbols in the shareable image have their correct addresses. Chapter 3 (x86-64 and I64) and Chapter 7 (Alpha and VAX) provide more information about image initialization.

- **Image optimization.** For OpenVMS Alpha images, the linker can perform certain optimizations to improve the run-time performance of the image it is creating. These optimizations include replacing JSR instruction sequences with the more efficient Branch to Subroutine (BSR) instruction sequence wherever the language processors specify. For OpenVMS I64 images, the linker can optimize data references to the short data segment. For more information, see Chapter 3 (I64) and Chapter 7 (Alpha and VAX).

1.1.4. Using the Linker

You start the linker interactively by entering the LINK command together with the appropriate input file names at the DCL prompt. You can also start the linker by including the LINK command in a command procedure. For more information about starting the linker, see Chapter 10.

The simple program shown in Example 1.1 prints the greeting “Hello World!” on the terminal.

Example 1.1. Hello World! Program (HELLO.C)

```
#include
<stdio.h>main() {
    printf( "Hello World!\n" );
}
```

To run this program, you must first compile the source file to create an object module. To compile this VSI C example, invoke the appropriate VSI C compiler to create an object module, as in the following example:

```
$ CC HELLO
```

During compilation, the compiler translates the statements in the source file into machine instructions and groups portions of the program into program sections according to their memory use and other characteristics. In addition, the compiler lists all the global symbols defined in the module and referenced by the module in the symbol table. In Alpha and VAX object modules, this table is also called a **global symbol directory** (GSD). In Example 1.1, the `printf` routine is referenced by the module but is not defined in it. The `printf` routine is defined in the VSI C Run-Time Library (DECC\$SHR).

To create an executable image, you usually link the object file produced by the compiler, as in the following example:

```
$ LINK HELLO
```

By default, the linker processes DECC\$SHR because it resides in the default system shareable image library [IMAGELIB.OLB]. Because of this, you do not need to specify this as input unless you are changing the behavior of the default library scans (for example, linking with /NOSYSLIB). See Section 2.2.3.3 (x86-64 and I64) and Section 6.2.3.3 (Alpha and VAX) for more information about how the linker processes default system libraries.

The linker processes the input files you specify in two passes. In its first pass through the input files, the linker resolves symbolic references between the modules. Because the linker processes different types of input files in different ways, the order in which you specify input files can affect symbol resolution. Chapter 2 (x86-64 and I64) and Chapter 6 (Alpha and VAX) provide more information about this topic.

After performing symbol resolution and determining all the input modules necessary to create the image, the linker ascertains the memory requirements of the image based on the memory requirements of the input files. The compilers have specified the memory requirements of the object modules as program section attributes.

On Alpha and VAX systems, the linker gathers together program sections with similar attributes into image sections. At activation time, the image activator reads the memory requirements of the image that the linker has stored in the image file by processing the list of image section descriptors (ISDs) and begins to set up the image for execution. Chapter 7 provides more information about Alpha and VAX image creation.

On x86-64 and I64 systems, the linker gathers ELF sections with similar attributes into ELF segments. At run-time, the image activator reads the memory requirements of the image that the linker has stored in the image file by processing the segments. Chapter 3 provides more information about creation of x86-64 and I64 images.

If the image that results from the link operation is an executable image, it can be executed at the DCL command line. The following example illustrates how to execute the program in Example 1.1:

```
$ RUN HELLO
Hello World!
```

Note that a LINK command required to create a real application, unlike the Hello World! example, can involve specifying hundreds of input files of various types.

As with most other DCL commands, the LINK command supports numerous qualifiers with which you can control various aspects of a link operation. The linker also supports linker **options**, which you can use to further control a link operation. Linker options can be specified in an options file, which is then specified as an input file in a link operation. Section 1.2.5 describes the benefits of using options files and describes how to create them. Chapter 10 provides descriptions of the qualifiers and options supported by the linker. Section 1.4 contains a summary table of these qualifiers and options.

1.2. Specifying Input to the Linker

You specify the files you want the linker to process on the LINK command line or in a linker options file. (Library files may also be specified as a user library, which the linker processes by default). You must specify at least one input file in every link operation and, in every link operation, at least one input file must be an object module. Table 1.1 lists the different types of input files accepted by the linker, along with their default file types. (The defaults are used on all OpenVMS platforms). The table also describes how you can specify the file in a link operation.

Table 1.1. Input Files Accepted by the Linker

File	Default File Type	Description
Object file	.OBJ	Created by a language processor. May be specified on the LINK command line or in a linker options file. This is the default input file accepted by the linker.
Shareable image	.EXE	Produced by a previous link operation. Must be specified in a linker options file; you cannot specify a shareable image as an input file on the command line. Identify the input file as a shareable image by appending the /SHAREABLE qualifier to the file specification.
Library file	.OLB	Produced by the Librarian utility. May contain object modules or shareable images. May be specified on the LINK command line, in a linker options file, or as a default user library processed by the linker. Identify the input file as a library file by appending the /LIBRARY qualifier to the library file specification. You can also include specific modules from a library in a link operation by appending the /INCLUDE qualifier to the library file specification.
Symbol table file	.STB	Produced by a previous link operation or a language processor. May be specified on the LINK command line or in an options file. Because a symbol table file is processed as an object module, it requires no identifying qualifier. Note that symbol table files produced by the linker during x86-64, I64, and Alpha links cannot be specified as input files in a link operation. They are intended to be used only as an aid to debugging with the System Dump Analyzer utility (see Section 1.2.4 for more information).

File	Default File Type	Description
Options file	.OPT	Text file containing link option specifications or link input file specifications. May be specified only on the command line; you cannot specify an options file inside another options file. Identify the input file as an options file by appending the /OPTIONS qualifier to the end of the file specification.

Only object files and image files of the same architecture can be combined to create an image.

Note

OpenVMS VAX images can run as translated images on OpenVMS Alpha and I64 systems. Similarly, OpenVMS Alpha images can run as translated images on I64 systems. Translated images can interoperate with native OpenVMS images.

For information about migrating applications from VAX to Alpha, see *Migrating an Application from OpenVMS VAX to OpenVMS Alpha*.

For information about migrating applications from Alpha to I64, see *Porting Applications from VSI OpenVMS Alpha to VSI OpenVMS Industry Standard 64 for Integrity Servers*.

1.2.1. Object Modules as Linker Input Files

When a language processor translates a source language program, it produces an output file that contains one or more object modules. This output file, called an object file, has the default file type of .OBJ and is the primary form of linker input. At least one object file must be specified in any link operation. An object file may be specified in the command line or in an options file.

For example, in Example 1.1, the only input file specified on the LINK command line is the object module named HELLO.OBJ (the .OBJ file type does not need to be specified because it is the default):

```
$ LINK HELLO
```

The linker processes the entire contents of an object file, that is, every object module in the file. It cannot selectively process object modules within an object file. The linker can process object modules selectively in an object module library (.OLB) file only.

You cannot examine an object module by using a text editor. The only way to examine an object file is by using the ANALYZE/OBJECT utility. This utility produces a report that lists the records that make up the object module. This report is primarily useful to compiler writers. For information about using the ANALYZE command, see the *VSI OpenVMS DCL Dictionary*.

1.2.2. Shareable Images as Linker Input Files

In order to execute code or reference data from a shareable image, the image must first be referenced by another image. That is, a shareable image can serve as input to a link operation for that image. To provide useful input for a link operation, the shareable image offers symbols (for example, procedure names) that are external to the other input modules of the image. As a result, when the image is run, the image activator activates the shareable image at the same time so that code and data from the shareable image can be referenced.

Note

Another method for referencing a shareable image is to dynamically activate the image by calling `LIB$FIND_IMAGE_SYMBOL` and passing one of its symbols. For more information, see the *VSI OpenVMS RTL Library (LIB\$) Manual*.

A shareable image file consists of activation information, image binaries (code and data), and a symbol table. This symbol table contains definitions of universal symbols exported by the shareable image. A **universal symbol** is to a shareable image what a global symbol is to a module. That is, where a global symbol can be used to satisfy references external to an object module, a universal symbol can be used to satisfy references external to the shareable image.

Shareable images can provide the following benefits:

- **Reducing total link processing time.** Because the linker needs only to read the activation information and to process the symbol table in a shareable image, it takes less time for the linker to process a shareable image. The linker does not have to resolve symbolic references within the shareable image, sort program sections into the image, or initialize the image contents as it does when processing object modules.
- **Avoiding relinking entire applications.** You can create a shareable image that can be modified, recompiled, and relinked without causing the images that were linked against previous versions of the shareable image to be relinked. This is called **upward compatibility**. For more information about this topic, see Chapter 4 (x86-64 and I64) and Chapter 8 (Alpha and VAX).
- **Conserving disk space.** Because many different executable images can be linked against the same shareable image, it is necessary to keep only a single copy of the shareable image on the disk. (Images that are linked with shareable images do not actually contain a copy of the shareable image).
- **Conserving physical memory.** Because the system can map the shareable pages of an installed shareable image into the address space of many processes, each process does not need to have its own copy of these pages. Note that, to achieve this benefit, the shareable image must be installed using the Install utility, specifying the `/SHARED` qualifier.
- **Reduction of paging I/O.** Because a page in an installed shareable image may be mapped into the working set of several processes, it is more likely to be in physical memory, reducing paging I/O. Note that, to achieve this benefit, the shareable image must be installed using the Install utility, specifying the `/SHARED` qualifier.
- **Implementing memory-resident databases.** Because installed shareable images are memory resident, they simplify the implementation of applications, such as data acquisition and control systems, where response times are so critical that control variables and data readings must remain in main memory.

1.2.2.1. Including a Shareable Image in a Link Operation

To include a shareable image in a link operation, you must specify the shareable image in an options file, identifying the input file as a shareable image by appending the `/SHAREABLE` qualifier to the file specification. You cannot specify a shareable image as an input file on the `LINK` command line. The following example illustrates an options file, named `MY_OPTIONS_FILE.OPT`, that contains an input file specification of the shareable image (the `.EXE` file type does not need to be specified because it is the default):

```
MY_SHARE /SHAREABLE
```

The following example illustrates the LINK command in which the options file is specified. For more information about creating and using shareable images, see Chapter 4 (x86-64 and I64) and Chapter 8 (Alpha and VAX). Note that the default file types for the options file and the object module do not need to be specified.

```
$ LINK MY_MAIN_PROGRAM,MY_OPTIONS_FILE/OPTIONS
```

By default, if you do not specify the device and directory in the file specification, the linker looks for shareable images in your default device and directory.

You link against shareable images in a shareable image library by specifying the library on the LINK command line or in a linker options file, identifying the file as a library by appending the /LIBRARY qualifier to the library file specification. You can include specific shareable images from the library in the link operation by appending the /INCLUDE qualifier to the library file specification, specifying which shareable images you want to include as parameters. For more information about specifying library files in a link operation, see Section 1.2.3. By default, the linker looks for user library files in the current default directory.

Note that images that link against shareable images do not contain the shareable image but only a reference to it. When the executable image is activated, the image activator activates all the shareable images to which it has been linked. By default, each image maps its own copy of the shareable image's pages.

1.2.2.2. Installing a Shareable Image

If you install the shareable image (using the Install utility), all processes can share the same physical copy of the shareable image in memory. To take advantage of this feature, you must specify the ADD subcommand and the /SHARED qualifier on the INSTALL command line, as in the following example:

```
$ INSTALL ADD/SHARED WORK:[PROGRAMS]MY_SHARE.EXE
```

The system creates a set of global sections for the portions of the shareable image that can be shared. The system can map these portions as global sections into the address space of multiple processes. For portions of the image that are not shareable, each process gets a private copy at image activation time. For help in creating an image on x86-64 and I64 systems, see Chapter 3. For similar information on Alpha and VAX systems, see Chapter 7.

If you do not install the shareable image specifying the /SHARED qualifier, each process receives a private copy of the image. For information about installing images, see the *VSI OpenVMS System Manager's Manual*.

1.2.3. Library Files as Linker Input Files

A library file is a file produced by the Librarian utility (default file type is .OLB). The linker accepts object module libraries and shareable image libraries as input files.

1.2.3.1. Creating a Library File

You create a library by specifying the /CREATE qualifier with the LIBRARY command. In the following example, the object module MY_PROG.OBJ is inserted into the library MY_LIB.OLB:

```
$ LIBRARY/CREATE/INSERT MY_LIB MY_PROG
```

A library file contains a library header and a name table. A library name table lists all of the global symbols in all of the modules and shareable images inserted in the library and associates the name of the symbol with the name of the module or shareable image in which it is defined.

Object module libraries contain copies of the object module. Shareable image libraries contain only the names of the shareable images. However, both object and shareable image libraries contain a name table, each entry associated with a definition in an object module or shareable image. Note that this is not the full symbol table of a module or a shareable image.

You cannot examine a library file using a text editor. To find out which modules a library contains, start the Librarian utility with the /LIST qualifier. The Librarian utility lists the symbols defined in these modules if you also specify the /NAMES qualifier. In the following example, the library MYMATH_LIB.OLB contains the object module MYMATHROUTS.OBJ, which contains the definitions of the symbols myadd, mysub, mydiv, and mymul:

```
$ LIBRARIAN/LIST/NAMES MYMATH_LIB
Directory of ELF OBJECT library WORK:[PROGS]MYMATH_LIB.OLB;1 on 8-MAR-2019 09:59:06
Creation date: 8-MAR-2019 09:58:53      Creator: Librarian I01-42
Revision date: 8-MAR-2019 09:58:53      Library format: 6.0
Number of modules: 1                    Max. key length: 1024
Other entries: 4                        Preallocated index blocks: 213
Recoverable deleted blocks: 0           Total index blocks used: 2
Max. Number history records: 20         Library history records: 0
Module MYMATHROUTS
MYADD
MYDIV
MYMUL
MYSUB
```

For more information about creating and using libraries, see the *VSI OpenVMS Command Definition, Librarian, and Message Utilities Manual*.

1.2.3.2. Including a Library File in a Link Operation

You can specify a library file in a link operation in any of the following ways:

- **Using the /LIBRARY qualifier.** You can specify a library file on the LINK command line or in an options file, identifying the input file as a library by appending the /LIBRARY qualifier.

When the linker processes a library file, it searches the library's name table for the definitions of symbols referenced in the other input files it has processed previously in the link operation. Note that the order in which the linker processes a library file can affect symbol resolution. For more information, see Chapter 2 (x86-64 and I64) and Chapter 6 (Alpha and VAX).

When the linker finds the symbol name of a definition in the library's name table, it includes the associated library element in the link operation and processes it as it would any other object module or shareable image. For object module libraries, the linker extracts the object module from the library. For shareable image libraries, the linker takes the image name from the library and attempts to translate it in order to find the image. If that fails, the linker looks for the shareable image in the device and directory in which the library resides. If the linker cannot find the shareable image at this location, it looks in the directory pointed to by the logical name X86\$LIBRARY for x86-64 links, IA64\$LIBRARY for I64 links, ALPHA\$LIBRARY for Alpha links, and SYS\$LIBRARY for VAX links.

- **Using the /INCLUDE qualifier.** You can include specific modules from a library into a link operation by appending the /INCLUDE qualifier to the library file specification. You specify the modules you want included in the link operation as arguments to the qualifier.

Note, however, that the linker does *not* process the name table of a library file specified using the /INCLUDE qualifier. The linker includes from the library the modules specified as arguments to the /INCLUDE qualifier into the link operation and processes them as it would any other object module or shareable image.

If you append both the `/LIBRARY` qualifier and the `/INCLUDE` qualifier to a library file specification, the linker processes the library's name table and also includes the specified modules in the link operation.

- **Defining the library as a default user library.** You can include a library in a link operation by defining it as a default user library. To define a default user library, assign the name of the library as the value of one of the linker's `LNK$LIBRARY` logical names. The linker processes libraries pointed to by these logicals after processing all the other input files specified in the link operation. See Section 2.2.3.3 (x86-64 and I64) and Section 6.2.3.3 (Alpha and VAX) for more information about default library processing.

1.2.4. Symbol Table Files as Linker Input Files (VAX Only)

A symbol table file is the product of a previous link operation or a language processor. A symbol table file is similar to an object module but it contains only a symbol table.

For VAX linking, you can specify a symbol table file as input in a link operation as you would any other object module, as in the following example:

```
$ LINK MY_MAIN_PROGRAM, MY_SYMBOL_TABLE
```

Note

On 64-bit systems, you cannot specify a symbol table as input in a link operation.

The linker processes the symbol table file during symbol resolution. If the symbol table file is the by-product of a link operation in which an executable image or system image was created, the symbol table contains the names and values of every global symbol in the image. If the symbol table file is associated with a shareable image, it contains by default the names and values of the symbols in the image declared as universal.

For a symbol table file to be useful in link operations, the values associated with the symbols in the symbol table file must be constants. The value of symbols that represent addresses, such as a procedure entry point, can vary each time the image is activated (unless the image is based).

Note also that a symbol table file associated with a shareable image should not be specified as an input file in a link operation in place of the shareable image. The shareable image itself must be specified as input because the linker requires more information than can be found in a symbol table file, such as the memory requirements of the shareable image (contained in the image header).

Symbol table files created by the linker on 64-bit systems can be used as an aid to debugging with the System Dump Analyzer utility (SDA).

1.2.5. Options Files as Linker Input Files

An options file is a standard text file you must use to specify linker options and shareable images specified as input files. You cannot specify linker options or shareable images on the `LINK` command line. Linker options, similar to linker qualifiers, allow you to control various aspects of the linker operation. Chapter 10 includes descriptions of the options supported by the linker.

In addition, you can use options files to perform the following tasks:

- Specifying frequently used input file specifications

- Entering LINK commands that might exceed the buffer capacity of the command language interpreter

When creating a linker options file, keep in mind the following restrictions:

- Separate input file specifications with a comma (.).
- Do not enter any linker qualifiers except those required to identify input files or modules, such as the /SELECTIVE_SEARCH, /LIBRARY (optionally followed by /INCLUDE) or /SHAREABLE (optionally followed by /SELECTIVE_SEARCH) qualifier.
- Do not specify an options file within an options file.
- Enter at most one option per line.
- Continue a line by entering the continuation character (the hyphen (-)) at the end of the line.
- Enter comments after an exclamation point (!).
- You may abbreviate the name of a link option to as few letters as needed to make the abbreviation unique.

Example 1.2 illustrates an options file, named PROJECT3.OPT, that contains both input file specifications and linker options.

Example 1.2. Sample Linker Options File

```
MOD1.OBJ,MOD7.OBJ,LIB3.OLB/LIBRARY,-  
LIB4/LIBRARY/INCLUDE=(MODX,MODY,MODZ),-  
MOD12.OBJ/SELECTIVE_SEARCH  
STACK=75  
SYMBOL=JOBCODE,5
```

To use an options file in a link operation, specify the name of the options file on the command line, identifying the file as an options file by appending the linker qualifier /OPTIONS to the file specification (the .OPT file type does not need to be specified because it is the default), as in the following example:

```
$ LINK PROGA,PROGB,PROJECT3/OPTIONS
```

If you precede the link operation with the SET VERIFY command, DCL displays the contents of the options file as the file is processed.

If you want to use an options file in a command procedure or interactively on the command line, specify the input file as the logical name SYSS\$INPUT, appending the /OPTIONS qualifier to the logical name. DCL interprets the lines immediately following the LINK command as the contents of the options file. The following example illustrates a LINK command in a command procedure:

```
$ ! LINK command  
$ LINK MAIN,SUB1,SYSS$INPUT/OPTIONS  
MYPROC/SHAREABLE  
SYS$LIBRARY:APPLPCKGE/SHAREABLE  
STACK=75  
$
```

When you specify SYSS\$INPUT as an interactive options file, you must terminate the options file by entering the Ctrl/Z key sequence, as in the following example:

```
$ LINK MAIN,SUB1,SUB2,SYSS$INPUT:/OPTIONS  
MYPROC/SHAREABLE  
SYS$LIBRARY:APPLPCKGE/SHAREABLE  
STACK=75  
Ctrl/Z
```

It is recommended to use command procedures to invoke the LINK command because it enables you to keep both the LINK command and all input file specifications, including any options files, together in a single file. To perform a link operation using a command procedure, simply invoke the command procedure, as in the following example:

```
$ @LINKPROC
```

1.3. Specifying Linker Output Files

The primary output generated by the linker is an image file. In addition, the linker can generate other output files:

- On all platforms, a symbol table file and a map file
- On 64-bit systems, a debug symbol file

Table 1.2 lists all the output files created by the linker.

Table 1.2. Output Files Generated by the Linker

File	Default File Type	Description
Executable image	.EXE	A program that can be run at the command line. This image is the default output file created by the linker. Specify the /EXECUTABLE qualifier to create an executable image.
Shareable image	.EXE	A collection of procedures and data that usually can be referenced after being included in a link operation in which another image is created. Specify the /SHAREABLE qualifier to create a shareable image.
System image ¹	.EXE	A program that is meant to be run as a standalone system. Specify the /SYSTEM qualifier to create a system image.
Symbol table file	.STB	An object module containing the global symbol table from an executable or system image, or the universal symbol table from a shareable image. Specify the /SYMBOL_TABLE qualifier to create a symbol table file.
Map file	.MAP	A text file created by the linker that provides information about the layout of the image and statistics about the link operation. Specify the /MAP qualifier to create a map file.
Debug symbol file ²	.DSF	A file containing debug information for use by the OpenVMS Debugger or System Code Debugger. Specify the /DSF qualifier to create a debug symbol file. <i>See VSI OpenVMS Debugger Manual and Writing OpenVMS Alpha Device Drivers in C for guidelines on using the system code debugger.</i>

¹Alpha and VAX specific

²64-bit specific

You cannot examine an image file using a text editor. To examine an image file, check for errors in image format, and obtain other information about the image, you must use the ANALYZE/IMAGE utility. See the *VSI OpenVMS DCL Dictionary* for information about using this utility.

1.3.1. Creating an Executable Image

An executable image is a file that can be executed by the RUN command.

On x86-64 and I64 systems, an executable image conforms to the ELF specification. Typically, this image consists of header tables, note sections containing the image identification information, a dynamic segment containing the image activation information and shareable image dependencies, and program segments containing the image binaries that define the memory requirements of the image.

On Alpha and VAX systems, an executable image is usually made up of an image header which contains image identification information and the image section descriptors (ISDs) that define the memory requirements and shareable image dependencies of the image binaries.

An executable image can reference one or more shareable images.

To create an executable image, you can specify the /EXECUTABLE qualifier. Note, however, that the linker creates executable images by default. For example, the command used to create the executable image in Example 1.1 did not specify the /EXECUTABLE qualifier:

```
$ LINK HELLO
```

By default, the linker uses the name of the first input file specified as the name of the image file, giving the file the .EXE file type. However, you can alter this default naming convention. For more information, see the LINK command description in Chapter 10.

1.3.2. Creating a Shareable Image

A shareable image is similar in structure and content to an executable image, though it differs in the way that shareable program sections are sorted. To make use of a shareable image, include it in a link operation in which another image is created.

In x86-64 and I64 images, the symbol table is an ELF section that contains the symbol information.

In Alpha and VAX images, the symbol table resembles an appended object module that only contains the symbol information.

Note that the following LINK command includes an options file using SYS\$INPUT. To make symbols in the shareable image available for other images to link against, you must declare them as universal symbols in a linker options file. The mechanism used to declare universal symbols for I64 and Alpha linking differs from VAX linking. For information and examples about creating and using shareable images, see Chapter 4 (x86-64 and I64) and Chapter 8 (Alpha and VAX).

To create a shareable image, specify the /SHAREABLE qualifier in the LINK command line, as in the following example:

```
$ LINK /SHAREABLE MY_SHARE, SYS$INPUT/OPTIONS
SYMBOL_VECTOR=( -
MY_ROUTINE=PROCEDURE, -
MY_COUNTER=DATA)
$
```

1.3.3. Creating a System Image (Alpha and VAX)

A system image is an image that does not run under the control of the operating system. It is intended for standalone operation only.

On x86-64 and I64 systems, system images have no special format; they are simply OpenVMS images that conform to the ELF specification. These system images might have constraints that you may have to address (for example, limits to the number of program segments).

By default, Alpha and VAX system images do not contain an image header, as do executable and shareable images. You can create a system image with a header by specifying the `/HEADER` qualifier. System images do not contain global symbol tables.

To create an Alpha or VAX system image, specify the `/SYSTEM` qualifier in the `LINK` command line, as in the following example:

```
$ LINK/SYSTEM MY_SYSTEM_IMAGE
```

1.3.4. Creating a Symbol Table File

A symbol table file is like an object module that contains all the global symbol definitions in the image. You can create a symbol table for any type of image: executable, shareable, or system. For executable images and system images, the symbol table contains a listing of the global symbols in the image. For shareable images, the symbol table lists the universal symbols in the image.

On 64-bit systems, the symbol table files created by the linker cannot be used as input files in subsequent link operations.

For VAX linking, symbol table files can be specified as input files in link operations. For more information, see Section 1.2.4.

On all platforms, symbol table files are intended to be used with SDA as an aid to debugging.

To create a symbol table file, specify the `/SYMBOL_TABLE` qualifier in the `LINK` command line. In the following link operation in which an executable image is created, a symbol table file is requested:

```
$ LINK/SYMBOL_TABLE MY_EXECUTABLE_IMAGE
```

By default, the linker uses the name of the first input file specified as the name of the symbol table file, giving the file the `.STB` file type. However, you can alter this default naming convention. For more information, see the description of the `/SYMBOL_TABLE` qualifier in Chapter 10.

1.3.5. Creating a Map File

The linker can generate a diagnostic file, called an **image map**, which you can use to locate link-time errors, to study the image layout, and to keep track of global symbols. The image map provides information about the linking process, including the following types of information:

- A listing of the object modules included in the link operation
- A listing of the image segments (on x86-64 and I64 systems) or image sections (on Alpha and VAX systems) created by the linker for the image
- A listing of all the program sections created by the linker
- A listing of all the global and universal symbols resolved by the linker for the image
- A compilation of summary statistics about the link operation

To create an image map file, specify the `/MAP` qualifier on the `LINK` command line. In batch mode, the linker creates a map file by default. When you invoke the linker interactively (at the `DCL`

command prompt), you must request a map explicitly. By default, the linker uses the name of the first input file specified as the name of the map file, giving the file the .MAP file type. However, you can alter this default naming convention. For more information, see the LINK command description in Chapter 10.

For example, to generate a map file in Example 1.1, you would specify the /MAP qualifier as in the following example:

```
$ LINK/MAP HELLO
```

You can determine the information contained in the image map by specifying additional qualifiers that are related to the /MAP qualifier. For example, by specifying the /BRIEF qualifier with the /MAP qualifier, you can generate a map file that contains only a subset of the total information that can be returned. For information about creating a map file and the contents of a map file, see Chapter 5 (x86-64 and I64) and Chapter 9 (Alpha and VAX).

1.3.6. Creating a Debug Symbol File (64-Bit Systems)

On 64-bit systems, a debug symbol file (DSF) is a file containing debug information for use by the OpenVMS Debugger and the System Code Debugger (SCD). To create a debug symbol file, specify the /DSF qualifier in the LINK command line, as in the following example:

```
$ LINK/DSF MY_PROJ.OBJ
```

By default, the linker uses the name of the first input file specified as the name of the DSF file, giving the file the .DSF file type. However, you can alter this default naming convention. For more information, see the description of the /DSF qualifier in Chapter 10.

1.4. Controlling a Link Operation

The linker allows you to control various aspects of the link operation by specifying qualifiers and options. The following sections summarize the qualifiers and options supported by the linker. The remaining chapters of this manual describe how to use these qualifiers and options, and Chapter 10 provides reference information about each linker qualifier and option.

1.4.1. Linker Qualifiers

As with any DCL command, the LINK command supports qualifiers that allow you to control aspects of linker processing. The qualifiers supported by the linker allow you to:

- **Identify input files.** For example, you must identify library files by appending the /LIBRARY qualifier to the file specification. Section 1.2 describes these qualifiers.
- **Specify output files.** For example, you must specify the /SHAREABLE qualifier to direct the linker to create a shareable image. Section 1.3 describes these qualifiers.
- **Control symbol resolution.** For example, if you specify the /NOSYSLIB qualifier, the linker will not process the default system object library or the default system image library. Chapter 2 (x86-64 and I64) and Chapter 6 (Alpha and VAX) contain more information about this topic.
- **Control image file creation.** For example, if you specify the /CONTIGUOUS qualifier, the linker attempts to allocate contiguous disk blocks for the image file. Chapter 3 (x86-64 and I64) and Chapter 7 (Alpha and VAX) contain more information about this topic.

Table 1.3 lists the LINK command qualifiers alphabetically.

Table 1.3. Linker Qualifiers

Qualifier	Supported Platform	Description
/ALPHA	Alpha, VAX	Directs the linker to build an OpenVMS Alpha image. Section 1.5 describes this qualifier in more detail.
/BASE_ADDRESS	x86-64, I64	Directs the linker to suggest a starting address for an executable image, when used in the boot process. This starting address is ignored by the image activator.
/BPAGE	All	Specifies the page size the linker should use when creating image sections or segments.
/BRIEF	All	Directs the linker to create a brief image map. Must be specified with the /MAP qualifier.
/CONTIGUOUS	All	Directs the linker to attempt to store the output image in contiguous disk blocks.
/CROSS_REFERENCE	All	Directs the linker to replace the Symbols By Name section of the image map with the Symbol Cross-Reference section. Must be specified with the /MAP qualifier.
/DEBUG	All	Directs the linker to include debug information in the image and to give control to the OpenVMS Debugger when the image is run.
/DEMAND_ZERO	64-bit platforms	Controls how the linker creates demand-zero image sections or segments.
/DNI	x86-64, I64	Controls the processing of demangling information.
/DSF	64-bit platforms	Directs the linker to create a file called a debug symbol file (DSF) for use by OpenVMS debuggers.
/EXECUTABLE	All	Directs the linker to create an executable image.
/FP_MODE	x86-64, I64	Directs the linker to set the program's initial floating-point mode in case it was not supplied by the main module.
/FULL	All	Directs the linker to create a full image map. Used only with the /MAP qualifier.
/GST	64-bit platforms	Directs the linker to include symbols that have been declared universal in the global symbol table (GST) of a shareable image. Use /NOGST to create an image with an empty GST. As such, /NOGST allows you to ship a shareable image that cannot be linked against. This qualifier is not supported for VAX linking.
/HEADER	All	Directs the linker to include an image header in a system image. Used only with the /SYSTEM

Qualifier	Supported Platform	Description
		qualifier. Accepted on x86-64 and I64, but not processed.
/INCLUDE	All	Identifies the input file to which it is appended as a library file and directs the linker to include specific modules from the library in the link operation.
/INFORMATIONALS	All	Directs the linker to output informational messages produced by a link operation. /NOINFORMATIONALS directs the linker to suppress informational messages.
/LIBRARY	All	Identifies the input file to which it is appended as a library file.
/MAP	All	Directs the linker to create an image map.
/NATIVE_ONLY	Alpha, I64	Directs the linker to create an image that cannot operate with a translated OpenVMS image.
/OPTIONS	All	Identifies an input file as a linker options file.
/POIMAGE	All	Directs the linker to mark the specified executable image as one that can run only in P0 address space.
/PROTECT	All	Directs the linker to protect the shareable image from user-mode and supervisor-mode write access. Used with the /SHAREABLE qualifier when the linker creates a shareable image.
/REPLACE	Alpha	Directs the linker to perform certain optimizations that improve the performance of the resulting image.
/SECTION_BINDING	Alpha	Directs the linker to check whether the image to be created contains dependencies on the layout of image sections that could interfere with the performance enhancement if installed resident.
/SEGMENT_ATTRIBUTE	x86-64, I64	Directs the linker to set attributes for image segments.
/SELECTIVE_SEARCH	All	Directs the linker to include only those global symbols that are defined in the module or image and referenced by previously processed modules.
/SHAREABLE	All	Directs the linker to create a shareable image. Can also be used to identify an input file as a shareable image.
/SYMBOL_TABLE	All	Directs the linker to create a symbol table file.
/SYSEXE	64-bit platforms	Directs the linker to process the OpenVMS executive file SYSS\$BASE_IMAGE.EXE (located in the directory pointed to by the logical name X86\$LOADABLE_IMAGES on x86-64 systems, IA64\$LOADABLE_IMAGES on I64 systems, or ALPHA\$LOADABLE_IMAGES on Alpha

Qualifier	Supported Platform	Description
		systems) to resolve references to symbols in a link operation.
/SYSLIB	All	Directs the linker to search the default system image library and the default system object library to resolve undefined symbolic references.
/SYSSHR	All	Directs the linker to search the default system shareable image library to resolve undefined symbolic references.
/SYSTEM	Alpha, VAX	Directs the linker to create a system image.
/THREADS_ENABLE	All	Directs the linker to enable features of the thread environment, in which the generated image is activated.
/TRACEBACK	All	Directs the linker to include traceback information in the image.
/USERLIBRARY	All	Directs the linker to search default user libraries to resolve undefined symbolic references. /USERLIBRARY accepts a keyword (ALL, GROUP, PROCESS, SYSTEM, or NONE) to further specify which logical name tables to search for the definitions of default user libraries.
/VAX	Alpha, VAX	Directs the linker to build an OpenVMS VAX image. Section 1.5 describes this qualifier in more detail.

1.4.2. Link Options

In addition to qualifiers, the linker supports options that allow you to control other aspects of a link operation, such as the following:

- **Specify image identification information.** Using options such as NAME=, ID=, and GSMATCH=, you can supply values to identify the image.
- **Declare universal symbols in shareable images.** Using the UNIVERSAL= option on VAX systems and the SYMBOL_VECTOR= option on 64-bit systems, you can make symbols in shareable images accessible to external modules.
- **Group input files together.** Using the CLUSTER= option or the COLLECT= option, you can specify which input files (or program sections in those input files) the linker should group together. This can affect the order of module processing and, therefore, symbol resolution.

Note that linker options must be specified in a linker options file. (See Section 1.2.5 for information about creating linker options files and specifying them in link operations).

Table 1.4 lists all the linker options alphabetically.

Table 1.4. Linker Options

Option	Supported Platform	Description
BASE=	VAX	Sets the base virtual address for the image.
CASE_SENSITIVE=	All	Determines whether the linker preserves the mixture of uppercase and lowercase characters used in arguments to linker options.
CLUSTER=	All	Directs the linker to create a cluster and to assign the cluster the specified name, and insert the input files specified in the cluster. Note that the base-address option value, which specifies the virtual address for the cluster, is valid on VAX, valid on Alpha for executable images only, and not accepted on x86-64 and I64. See Chapter 10 for information about CLUSTER= option and other option values.
COLLECT=	All	Moves the specified program sections into the specified cluster.
DZRO_MIN=	Alpha, VAX	Sets the minimum number of uninitialized, contiguous pages that must be found in an image section before the linker can extract the pages from the image section and create a demand-zero image section.
GSMATCH=	All	Sets match control parameters for a shareable image.
IDENTIFICATION=	All	Sets the image ID field.
IOSEGMENT=	All	Specifies the size of the image I/O segment.
ISD_MAX=	Alpha, VAX	Specifies the maximum number of image sections.
NAME=	All	Sets the image name field.
PROTECT=	All	Directs the linker to protect one or more clusters from user-mode or supervisor-mode write access. Can be used only with shareable images.
PSECT_ATTR=	All	Assigns values and attributes to program sections.
RMS_RELATED_CONTEXT=	All	Determines RMS related-name context processing, also known as file specification "stickiness".
STACK=	All	Sets the initial size of the user-mode stack.
SYMBOL=	All	Defines a global symbol and assigns it a value.
SYMBOL_TABLE=	64-bit platforms	Specifies whether a symbol table file, produced in a link operation in which a

Option	Supported Platform	Description
		shareable image is created, should contain all the global symbols as well as the universal symbols in the shareable image. By default, the linker includes only universal symbols.
SYMBOL_VECTOR=	64-bit platforms	Exports symbols in a shareable image, making them accessible to external images.
UNIVERSAL=	VAX	Declares the specified global symbol as a universal symbol, making it accessible to external images.

1.5. Linking for Different Architectures (Alpha and VAX)

You can create OpenVMS Alpha images on an OpenVMS VAX system and create OpenVMS VAX images on an OpenVMS Alpha system. To do this, you must mount a system disk of the target architecture and make it accessible on the system where the link is to occur. Also, you must assign logical names to point to portions of the target architecture disk.

Note

You cannot create OpenVMS x86-64 or I64 images on Alpha and VAX platforms, nor create images for Alpha or VAX on x86-64 and I64 systems.

Table 1.5 lists the logical names and the conditions of their use.

Table 1.5. Logical Names for Cross-Architecture Linking

Logical Name	Description
ALPHA\$LIBRARY	The linker uses this logical name when creating an OpenVMS Alpha image to locate the target system's shareable images and system libraries.
VAX\$LIBRARY	The linker uses this logical name when creating an OpenVMS VAX image on an OpenVMS Alpha computer to locate the target system's shareable images and system libraries.
SYSS\$LIBRARY	The linker uses this logical name when creating an OpenVMS VAX image on an OpenVMS VAX computer to locate the target system's shareable images and system libraries.
ALPHA\$LOADABLE_IMAGES	The linker uses this logical when creating an OpenVMS Alpha image to locate the target system's base image SYSS\$BASE_IMAGE.EXE when the /SYSEXE qualifier is in the link command line.

The /ALPHA and /VAX qualifiers control which architecture an image is built for:

- When you specify /ALPHA, the linker creates an OpenVMS Alpha image using the OpenVMS Alpha libraries and OpenVMS Alpha images from the target system disk that the logicals

ALPHA\$LIBRARY and ALPHA\$LOADABLE_IMAGES point to. When you link on an OpenVMS Alpha system, these logical names initially point to the current system's libraries and images. The qualifier /ALPHA is the default on OpenVMS Alpha systems.

- When you specify /VAX on an OpenVMS Alpha system, the linker creates an OpenVMS VAX image using the OpenVMS VAX libraries and OpenVMS VAX images from the target system disk that the logical VAX\$LIBRARY points to. On an OpenVMS VAX system, you create VAX images by using the OpenVMS VAX libraries and OpenVMS VAX images that the logical SYSS\$LIBRARY points to. The qualifier /VAX is the default on OpenVMS VAX systems.

Chapter 2. Understanding Symbol Resolution (x86-64 and I64)

This chapter describes how the linker performs symbol resolution on OpenVMS x86-64 and OpenVMS I64 systems.

For information on performing symbol resolution on OpenVMS Alpha and OpenVMS VAX systems, see Chapter 6.

As one of its primary tasks, the linker must resolve symbolic references between modules. This chapter describes how you can control the process to ensure that the linker resolves symbolic references as you intend.

2.1. Overview

Programs are typically made up of many interdependent modules. For example, one module may define a symbol to represent a program location or data element that is referenced by many other modules. The linker is responsible for finding the correct definition of each symbol referenced in all the modules included in the link operation. This process of matching symbolic references with their definitions is called **symbol resolution**.

2.1.1. Types of Symbols

Symbols can be categorized by their scope, that is, the range of modules over which they are intended to be visible. Some symbols, called **local symbols**, are meant to be visible only within a single module. Because the definition and the references to these symbols must be confined to a single module, language processors such as compilers can resolve these references.

Other symbols, called global symbols, are meant to be visible to external modules. A module can reference a global symbol that is defined in another module. Because the value of the symbol is not available to the compiler processing the source file, it cannot resolve the symbolic reference. Instead, a compiler creates an ELF symbol table (SYMTAB) in an object module that includes all of the global symbol references and global symbol definitions it contains. These symbols are part of the global symbol directory (GSD).

On x86-64 and I64 systems, the GSD has a conceptual meaning. It no longer indicates an area within an object module, in which all named entities are listed. For ELF objects, the named entities for data and code are listed in the ELF symbol table; the name identities for sections are listed in the section header table. To use the traditional name GSD on x86-64 and I64 systems, the GSD can be seen as a subset of the ELF symbol table, plus a subset of the section header table.

In most programming languages, you can explicitly specify whether a symbol is global or local by setting or omitting particular attributes in the symbol definition or reference. For example, in C all functions are global symbols by default but the functions with the *static* attribute are local symbols.

In shareable images, symbols that are intended to be visible to external modules are called universal symbols. A universal symbol in a shareable image is the equivalent of a global symbol in an object module. Note, however, that only those global symbols that have been declared as universal are listed in the ELF symbol table (SYMTAB) of the shareable image and are available to external modules to link against. These symbols are part of the global symbol table (GST).

Similar to the GSD, the GST has a conceptual meaning on x86-64 and I64 systems; that is, it no longer indicates an area within an image file, in which all named entities are listed. For ELF images, the named entities for data and code are listed in the ELF symbol table and the named entities for sections are listed in the section header table. To use the traditional name GST on x86-64 and I64 systems, the GST can be seen as a subset of the ELF symbol table, plus a subset of the section header table.

You must explicitly declare universal symbols as part of the link operation in which the shareable image is created. For more information about declaring universal symbols, see Chapter 4.

2.1.1.1. Understanding Strong and Weak Symbols

As on Alpha and VAX systems, the linkers on x86-64 and I64 systems support global symbols that can be **strong** or **weak**. Weak symbols can be one of two types: **VMS-style weak** and **UNIX-style weak**.

The VMS-style weak symbol is identical to the weak symbol on Alpha and VAX. Using VMS-style weak symbols reflects a programming concept where the developer marks a symbol as weak depending on available language support. For information about how the linker processes VMS-style weak symbols, see Section 2.5.

UNIX-style weak symbols are unique to x86-64 and I64 systems and primarily used by the C++ compiler. Using UNIX-style weak symbols reflects an implementation concept, where the compiler marks symbols as weak, depending on language constructs. For information about how the linker processes UNIX-style weak symbols, see Section 2.6.

2.1.1.2. Group Symbols

Global symbols can be gathered in a **group** which is seen by the linker as a single entity. All symbols in a group are included or excluded in the link process. The group is identified by its **group name**, which is also called a **group signature**. A group also defines a set of sections, which contain definitions or references of the group symbols. As with UNIX-style weak symbols, groups are an implementation concept, primarily used by the VSI C++ compiler. For more information about working with group symbols, see Section 2.6.

2.1.1.3. The C Extern Common Model

In some VSI programming languages, certain types of global symbols, such as external variables in the C **common extern model** and COMMON data in FORTRAN, are not listed in the symbol table as global symbol references or definitions. Because these data types implement virtual memory that is shared, the languages implement them as sections that are overlaid. Rather than appearing as global symbol definitions or references, these variable names emerge as section names. (Compilers use sections to define the memory requirements of an object module). Although this may look like symbol resolution to the user, the linker does not process symbols. For information about how the linker processes sections, see Chapter 3.

For example, this C definition and the Fortran data that follows are matched and address the same data:

```
#pragma extern_model common_block
struct { int first; int second; } numbers;
```

```
INTEGER*4 first, second
COMMON /numbers/ first, second
```

2.1.1.4. Tentative Definitions in C

In the VSI C programming language, external variables can be defined in a strict or a relaxed reference/definition model. The **strict model** allows only one strong definition. The **relaxed model**, allows several **tentative definitions**. Any initialized variable is a strong symbol definition in the strict model. All uninitialized variables can be relaxed or tentative definitions. For both types of external variables, strong global symbols are generated by the compiler. For a strong definition in any model, the compiler reserves memory in the defining module. For tentative definitions, the compiler does not reserve memory. Tentative definitions result in global symbols in the symbol table, marked as ELF common.

Note

Do not confuse the term "ELF common" with "Fortran common"; these are different concepts.

If there is one strong definition, the linker uses it as the primary definition and treats all the tentative definitions as references. Otherwise, the linker does the following:

- Creates a section named after the symbol to define memory for the tentative definitions.
- Assigns the first module with a tentative definition as the defining module.

The section created by the linker contains the overlay attribute. Any other section with the same name and the same attributes can overlay onto this section.

For example, the following C definitions are tentative:

```
/* module A */
#pragma extern_model relaxed_refdef
int my_data;
/* module B */ #pragma extern_model relaxed_refdef
int my_data;
```

The linker creates a section with memory for the variable and marks module A as the defining module for the section.

Note

The linker does not include section names in its symbol resolution processing. The name spaces for symbols and sections are separate. The overlaying of sections with a created section for a tentative definition with the same name does not produce an exception.

2.1.1.5. Considerations for C Language Extensions

On x86-64 and I64 systems, the VSI C language extensions `globalref` and `globaldef` allow you to create external variables that appear as symbol references and definitions in the symbol table. For more information, see the *VSI C User's Guide for OpenVMS Systems*.

In addition, VSI C supports command line qualifiers and source code pragma statements (as shown in the previous examples) that allow you to control the extern model. For more information, see the *VSI C User's Guide for OpenVMS Systems*.

2.1.2. Linker Symbol Resolution Processing

During its first pass through the input files specified in the link operation, the linker attempts to find the definition for every symbol referenced in the input files. By default, the linker processes all the

global symbols defined and referenced in the symbol table of each object module (GSD) and all the universal symbols defined in the global symbol table (GST) of each shareable image and any symbol defined by linker options. The definition of the symbol provides the value of the symbol. The linker substitutes this value for each instance where the symbol is referenced in the image being created. This value might not be the actual value of the virtual address at run-time, because the values might be relocated by the image activator.

The value of a symbol depends on what the symbol represents. A symbol can represent a routine entry point or a data location within an image. For these symbols, the value of the symbol is an address. A symbol can also represent a data constant (for example, the linker option `SYMBOL=X,10`). In this case, the value of the symbol is its actual value.

For symbols that represent addresses in object modules, the value is expressed initially as an offset into a section. (This is the manner in which language processors express addresses). Later in its processing, the linker determines the symbol's preliminary value after combining all module contributions into segments, which yields the proposed memory layout. For information about how the linker determines the virtual memory layout of an image, see Chapter 3.

For x86-64 and I64 images, at link time, the value of a symbol in a shareable image (as listed in the GST of the image) is the index of the symbol's entry in the symbol vector of the image.

An **x86-64 symbol vector entry** is a pair of quadwords. The contents of the two quadwords depend on whether the symbol represents a procedure entry point, data location, or absolute constant. For procedure entries, the first quadword is the procedure's canonical address (that is, its procedure value); and the second quadword is the procedure's actual entry address. For data locations and constant values, the first quadword contains the address, offset, or constant value, and the second quadword contains zero. Figure 2.1 shows the contents of the x86-64 symbol vector at link time and at image activation time.

Figure 2.1. Symbol Vector Contents on x86-64

	At Link Time:	After Image Activation:				
Procedure	<table border="1"> <tr><td>Procedure value offset</td></tr> <tr><td>Procedure entry offset</td></tr> </table>	Procedure value offset	Procedure entry offset	<table border="1"> <tr><td>Procedure value address</td></tr> <tr><td>Procedure entry address</td></tr> </table>	Procedure value address	Procedure entry address
Procedure value offset						
Procedure entry offset						
Procedure value address						
Procedure entry address						
Constant	<table border="1"> <tr><td>Constant value</td></tr> <tr><td>0</td></tr> </table>	Constant value	0	<table border="1"> <tr><td>Constant value</td></tr> <tr><td>0</td></tr> </table>	Constant value	0
Constant value						
0						
Constant value						
0						
Data	<table border="1"> <tr><td>Image offset of data cell</td></tr> <tr><td>0</td></tr> </table>	Image offset of data cell	0	<table border="1"> <tr><td>Virtual address of data cell</td></tr> <tr><td>0</td></tr> </table>	Virtual address of data cell	0
Image offset of data cell						
0						
Virtual address of data cell						
0						

An **I64 symbol vector entry** is a quadword that contains the value of the symbol. The contents of the quadword depends on whether the symbol represents a procedure entry point, data location, or a constant. At link time, a symbol vector entry for a procedure entry point or a data location is expressed as an offset into the image. At image activation time, when the image is loaded into memory and the base address of the image is known, the image activator converts the image offset into a virtual address. Figure 2.2 shows the contents of the I64 symbol vector at link time and at image activation time.

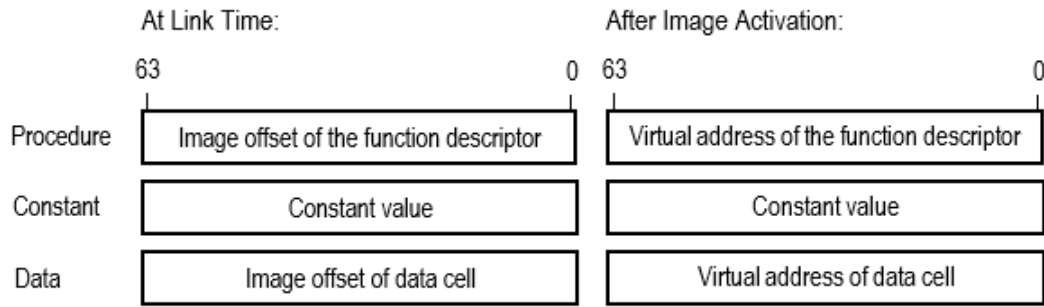
Figure 2.2. Symbol Vector Contents on I64

Note that the linker does not allow programs to make procedure calls to symbols that represent data locations.

The actual value of an address symbol in a shareable image is determined *at run-time* by the image activator when it loads the shareable image into memory. The image activator converts or **relocates** all the addresses within a shareable image when it loads the image into memory. Once it has determined the absolute values of these addresses, the image activator **fixes up** references to these addresses in the image that linked against the shareable image. When the image was linked, the linker created **fix-ups** that flag to the image activator where it must insert the actual addresses to complete the linkage of a symbolic reference to its definition in an image. The linker listed these fix-ups in the **fix-up table**, which is part of the **dynamic segment** created for the image. For more information about shareable images, see Chapter 4.

Note

For x86-64 and I64 images, you can not specify an address at which you want an image mapped into virtual memory. The image activator decides where to place the image.

Figure 2.3 illustrates the interdependencies created by symbolic references among the modules that make up an application. In the figure, arrows point from a symbol reference to a symbol definition. (The statements do not reflect a specific programming language).

Figure 2.3. Symbol Resolution

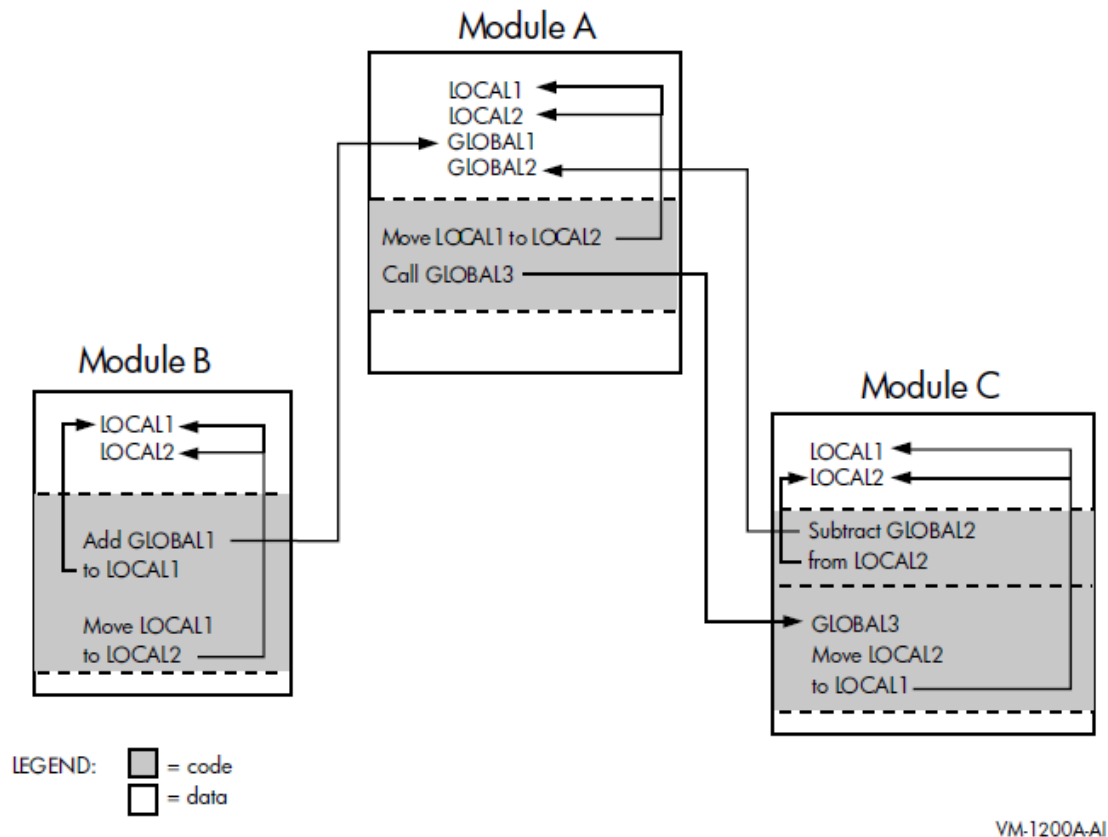

The linker creates an image, even if it cannot find a definition for every symbol referenced in the input files it processes. As shown in the following example, the linker reports these undefined symbols if at least one of the unresolved references is a strong reference. (For information about strong and weak symbolic references, see Section 2.5). The linker includes the message in the map file, if a map file was requested.

```
$ LINK MY_MAIN ! The module MY_MATH is omitted
%ILINK-W-NUDFSYMS, 1 undefined symbol:
❶ %ILINK-I-UDFSYM,          MYSUB
❷ %ILINK-W-USEUNDEF, undefined symbol MYSUB referenced
  section: $CODE$
  offset: %X00000000000000110 slot: 2
  module: MY_MAIN
  file: WORK:[PROGRAMS]MY_MAIN.OBJ;1
```

- ❶ The linker issues an informational message for each symbol for which it cannot find a definition.
- ❷ The linker issues a warning message for each instance where an undefined symbol is referenced in the image.

If you run an image that contains undefined symbols and the symbols are never accessed, the program runs successfully. However, if you run an image that contains undefined symbols and the image accesses the symbols at run-time, then the image will abort. In most cases, it aborts with an access violation because the linker assigns the value zero to undefined symbols or because the linker indicates that an undefined function symbol was called, as shown in the following example:

```

$ RUN MY_MAIN
%SYSTEM-F-CALLUNDEFSYM, Call using undefined function symbol
%TRACE-F-TRACEBACK, symbolic stack dump follows
image      module  routine  line    rel PC          abs PC
MY_MAIN
MY_MAIN MY_MAIN main      1594  0000000000000120 0000000000010120
MY_MAIN MY_MAIN __main   1586  00000000000000C0 00000000000100C0
                                0  FFFFFFFF80B7FB30 FFFFFFFF80B7FB30
DCL
                                0  0000000000006BD60 0000000007AE25D60
%TRACE-I-END, end of TRACE stack dump

```

2.2. Input File Processing for Symbol Resolution

The linker can include object modules, shareable images, and libraries in its symbol resolution processing. Options files do not play an important role in symbol resolution (the `SYMBOL=` option can define a symbol and its value).

By default, the linker includes all the symbol definitions from the object module or shareable image. However, if you append the `/SELECTIVE_SEARCH` qualifier to the object module or shareable image file specification, then the linker includes in its processing only those symbols that define symbols referenced in a previously processed input file. For more information about selectively processing input files, see Section 2.2.4.

Table 2.1 summarizes how the linker processes these different types of input files when performing symbol resolution.

Table 2.1. Linker Input File Processing

Input File	How Processed
Object file (.OBJ)	By default, the linker processes all the symbol definitions and references listed in the GSD of the module. If you append the <code>/SELECTIVE_SEARCH</code> qualifier to the input file specification, the linker includes only those symbol definitions from the GSD that resolve symbolic references found in previously processed input files.
Shareable image file (.EXE)	By default, the linker processes all symbol definitions listed in the GST of the image. However, the linker lists only those symbol definitions in the map file that are referenced by other modules in order to reduce map file clutter. If you append the <code>/SELECTIVE_SEARCH</code> qualifier to the input file specification, the linker includes in its processing only those symbol definitions from the GST that resolve symbolic references found in previously processed input files.
Library files (.OLB)	Specifying <code>/LIBRARY</code> , the linker searches the name table of the library for symbols that are undefined in previously-processed input files. (Usually, a library file's name table lists all the symbols available in all of the modules it contains). If the linker finds the definition of a symbol referenced by a previously-processed input file, it includes in the link operation, the library module containing the definition of the symbol. Once the object module or shareable image is included in the link operation, the linker processes it as any other object module or shareable image.

Input File	How Processed
	<p>If you append only the <code>/INCLUDE</code> qualifier to a library file specification, the linker does <i>not</i> search the library's name table to find undefined symbolic references. Instead, the linker includes the specified object module or shareable image specified as a parameter to the <code>/INCLUDE</code> qualifier.</p> <p>You cannot process a library file selectively. However, if the Librarian utility's <code>/SELECTIVE_SEARCH</code> qualifier was specified when the object module or shareable image was inserted into the library, the linker processes the module selectively when it extracts it from the library.</p>

2.2.1. Processing Object Modules

The linker resolves symbolic references with their definitions. For example, the program in Example 2.1 references the symbol `mysub`.

Example 2.1. Source File Containing a Symbolic Reference: `MY_MAIN.C`

```
#include <stdio.h>
int mysub( int value_1, int value_2 );
main()
{
    int num1, num2, result;
    num1 = 5;
    num2 = 6;
    result = 0;
    result = mysub( num1, num2 );
    printf( "Result is: %d\n", result );
}
```

`mysub`, which Example 2.1 references, is defined in the program in Example 2.2.

Example 2.2. Source File Containing a Symbol Definition: `MY_MATH.C`

```
int myadd( int value_1, int value_2 )
{
    int result;
    result = value_1 + value_2;
    return result;
}
int mysub ( int value_1, int value_2 )
{
    int result;
    result = value_1 - value_2;
    return result;
}
int mymul( int value_1, int value_2 )
{
    int result;
    result = value_1 * value_2;
    return result;
}
int mydiv( int value_1, int value_2 )
{
    int result;
    result = value_1 / value_2;
    return result;
}
```

The GSD created by the language processor for the object module `MY_MAIN.OBJ` lists the **reference** to the symbol `mysub`. Because object modules cannot be examined using a text editor, the following

representation of the GSD is taken from the output of the ANALYZE/OBJECT utility of the OpenVMS object module MY_MAIN.OBJ.

```
$ CC MY_MAIN.C
$ ANALYZE/OBJECT/SECTION=SYMTAB MY_MAIN.OBJ
.
.
.
Description                Hex <bitmask>    Decimal Interpretation
-----
Symbol 16. (00000010)      "MYSUB" ❶
  Name Index in Sec. 8.:    0000004C        76.
  Symbol Info Field:        12
    Symbol Type:            02              STT_FUNC ❷
    Symbol Binding:         01              STB_GLOBAL ❸
  Symbol 'Other' Field:    80
  Symbol Visibility        00              STV_DEFAULT
.
.
.
  Bound to section:         0000              0. (SHDR$K_SHN_UNDEF) ❹
  Symbol Value              0000000000000000 0. ❺
  Size associated with sym: 0000000000000000
```

- ❶ In Example 2.2, MYSUB is defined in lowercase characters: mysub. The C compiler automatically upper cases all external symbol names unless you use the qualifier /NAMES=AS_IS.
- ❷ The Symbol Type for MYSUB is STT_FUNC, which classifies MYSUB as a function (procedure). The linker checks the definition of mysub and make sure that its Symbol Type is also STT_FUNC. The linker issues an error if there is a discrepancy.
- ❸ The Symbol Binding for MYSUB is STB_GLOBAL. For most applications, symbol types fall into two categories: global (STB_GLOBAL) and local (STB_LOCAL). Global symbols are visible across modules. Local symbols are visible only within the module.
- ❹ References, or undefined symbols, are bound to a special section number which marks an undefined, missing, irrelevant or otherwise meaningless section (zero or SHDR\$K_SHN_UNDEF). Definitions are bound to a section with a number greater than zero.
- ❺ For references, the Symbol Value and the Size are not always known, and therefore are displayed as a zero.

The GSD created by the language processor for the object module MY_MATH.OBJ contains the **definition** of the symbol mysub, as well as the other symbols defined in the module. The definition of the symbol includes the value of the symbol.

The following excerpt from an analysis of the OpenVMS object module (performed using the ANALYZE/OBJECT utility) c.

```
$ CC MY_MATH.C
$ ANALYZE/OBJECT/SECTION=SYMTAB MY_MATH.OBJ
.
.
.
Description                Hex <bitmask>    Decimal Interpretation
-----
Symbol 12. (0000000C)      "MYSUB"
  Name Index in Sec. 8.:    00000027        39.
  Symbol Info Field:        12
    Symbol Type:            02              STT_FUNC
    Symbol Binding:         01              STB_GLOBAL
  Symbol 'Other' Field:    80
  Symbol Visibility        00              STV_DEFAULT
.
.
.
```

```

Bound to section:                0003          3. "$CODE$" ❶
Symbol Value                    0000000000000020 32. ❷
Size associated with sym: 0000000000000020    ❸

```

- ❶ Since MYSUB is a procedure, it is associated with a code section.
- ❷ The Symbol Value (32) is the byte offset of the code entry point into the section \$CODE\$.
- ❸ The Size associated with the symbol is the amount of code in the routine (32 bytes).

When you link the modules shown in Example 2.1 and Example 2.2 together to create an image, you specify both object modules on the command line, as in the following example:

```
$ LINK MY_MAIN, MY_MATH
```

When the linker processes these object modules, it reads the contents of the GSDs, obtaining the value of the symbol from the symbol definition.

For I64 images, the value of a symbol that is a function can be expressed in two ways:

- If the linker has created a **function descriptor** (called a procedure descriptor on Alpha) the value is the address of the function descriptor. This is listed in the Symbol Cross Reference portion of the map with the suffix -R or in the Symbols By Value portion of the map with the prefix R-.
- If the symbol is a function, and the linker has not created a function descriptor, the value of a symbol is the location within the image of the entry point of the function. This information is listed in the Symbol Cross Reference portion of the map with the suffix -RC or in the Symbols By Value portion of the map with the prefix RC-. R is the label that means relocatable, and C is the label that means code address.

The function descriptor created by the linker is a pair of quadwords that contain the Global Pointer (GP) for the image and the pointer to the entry point of the function. Note that on I64, the linker creates the function descriptors rather than the compiler. The linker also chooses the value for the GP, which is an address that the code segment uses to access the short data segment. It accesses different parts of the short data segment by using different offsets to the value the linker has chosen for the GP.

For x86-64 images, a function symbol's value is always a code address. There is no GP and no short data segment.

If the symbol is data, it can be either relocatable or not relocatable. The linker uses the R prefix or suffix in the map to indicate relocation.

2.2.2. Processing Shareable Images

When the linker processes a shareable image, it processes all the universal symbol definitions in the GST of the image. Because the linker creates the GST of a shareable image in the same format as an object module's symbol table, the processing of shareable images for symbol resolution is similar to the processing of object modules. The linker sets an attribute that flags the symbol as protected, which also indicates a universal symbol when the linker creates an image. Note that the linker includes only those universal symbols in the map file that resolve references, thus eliminating extraneous symbols in the linker map.

For example, the program in Example 2.2 (in Section 2.2.1) can be implemented as a shareable image. (For information about creating a shareable image, see Chapter 4). The shareable image can be included in the link operation as in the following example:

```
$ LINK/MAP/FULL MY_MAIN, SYS$INPUT/OPT
MY_MATH.EXE/SHAREABLE
Ctrl/Z
```

The GST created by the linker for the shareable image MY_MATH.EXE contains the **universal definition** of the symbol MYSUB, as well as the other symbols defined in the module.

Because images cannot be examined using a text editor, the following representations of the GST are taken from the output of the ANALYZE/IMAGE utility:

```
$ CC MY_MATH.C
$ LINK/MAP/FULL/CROSS/SHAREABLE MY_MATH.OBJ, SYS$INPUT/OPT
SYMBOL_VECTOR=(MYADD=PROCEDURE,-
                MYSUB=PROCEDURE,-
                MYMUL=PROCEDURE,-
                MYDIV=PROCEDURE)

Ctrl/Z
$ ANALYZE/IMAGE/SECTION=SYMTAB MY_MATH.EXE
Ctrl/Z
.
.
.
Symbol 3. (00000003)      "MYSUB"
Name Index in Sec. 2.:      0000000D      13.
Symbol Info Field:          12
Symbol Type:                02          STT_FUNC
Symbol Binding:             01          STB_GLOBAL
Symbol 'Other' Field:       93
Symbol Visibility           03          STV_PROTECTED
Function Type                10          VMS_SFT_SYMV_IDX
.
.
.
Bound to section:           0008          8. "$LINKER RELOCATABLE_SYMBOL"
Symbol Value                 0000000000000001  1.
Size associated with sym: 0000000000000000
```

For x86-64 and I64 images, STV_PROTECTED indicates a universal definition. The "Symbol Type", STT_FUNC, indicates that this symbol represents a function (or procedure). The Function Type, VMS_SFT_SYMV_IDX, indicates that the symbol value (in this case 1) is the index into the symbol vector of the pointer to the function descriptor for MYSUB.

The analysis also lists all the indexes in the symbol vector. The following Index, which matches the previous value for the symbol, is 1.

For x86-64 images, the entry in the symbol vector with the index value of 1 contains the values 00002080 and 80000020. The first value is the procedure value for MYSUB, and the second value is the code address of the entry point for MYSUB.

```
SYMBOL VECTOR                      4. Elements
-----
Index  Value                        Size      Symbol or Section Name
-----
0.    00000000000002070 PROCEDURE  "MYADD"
      0000000080000000
1.    00000000000002080 PROCEDURE  "MYSUB"
      0000000080000020
2.    00000000000002090 PROCEDURE  "MYMUL"
      0000000080000040
3.    000000000000020A0 PROCEDURE  "MYDIV"
      0000000080000060
.
.
.
```

For I64 images, the entry in the symbol vector with the index value of 1, contains the value 30080, which is the address of a function descriptor for MYSUB. The function descriptor is a quadword pair. The first quadword is the address of the entry point for MYSUB (10020). The address 10020 is in a segment that has the execute flag set (that is, a code segment). The second quadword contains the global pointer chosen by the linker for the image (230000).

SYMBOL VECTOR		4. Elements	
Index	Value	Entry/GP or Size	Symbol or Section Name
0.	0000000000030068	PROCEDURE 000000000010000 0000000000230000	"MYADD"
1.	0000000000030080	PROCEDURE 000000000010020 0000000000230000	"MYSUB"
2.	0000000000030098	PROCEDURE 000000000010040 0000000000230000	"MYMUL"
3.	00000000000300B0	PROCEDURE 000000000010090 0000000000230000	"MYDIV"
	.		
	.		
	.		

2.2.2.1. Implicit Processing of Shareable Images

For VAX linking, when you specify a shareable image in a link operation, the linker not only resolves symbols from the shareable image you specify but it also resolves symbols from all shareable images that the shareable image has been linked against (that is, the shareable image's dependency list).

The x86-64 and I64 linkers perform like the Alpha linker in that it does not automatically scan down a shareable image's dependency list to resolve symbols. Instead, on I64 an image's dependency list is in the dynamic segment. It appears in an analysis near the top of the file under the title Shareable Image List, as in the following example analysis of MY_MAIN.EXE:

```
$ LINK/MAP/FULL/CROSS MY_MAIN,SYS$INPUT/OPT
MY_MATH.EXE/SHAREABLE
Ctrl/Z
$ ANALYZE/IMAGE MY_MAIN
.
.
.
Image Activation Information, in segment 4.
  Global Pointer:                0000000000240000
  Whole program FP-mode:        IEEE DENORM_RESULTS
  Link flags
    Call SYS$IMGSTA
    Image has main transfer
    Traceback records in image file
  Shareable Image List
    MY_MATH
      (EQUAL, 9412., 468313704).
    DECC$SHR
      (LESS/EQUAL, 1., 1).
```

Note

If your VAX application's build procedure depends on implicit processing of shareable images, you may need to add these shareable images to your x86-64 or I64 linker options file.

2.2.3. Processing Library Files

Libraries specified as input files in link operations contain either object modules or shareable images. The way in which the linker processes library files depends on how you specify the library in the link

operation. Sections 2.2.3.1, 2.2.3.2, and 2.2.3.3 describe these differences. Note, however, that once an object module or shareable image is included from the library into the link operation, the linker processes the file as it would any other object module or shareable image.

For example, to create a library and insert the object module version of the program in Example 2.2 into the library, you could specify the following command:

```
$ LIBRARY/CREATE/INSERT MYMATH_LIB MY_MATH
```

The librarian includes the module in its module list and all of the global symbols defined in the module in its name table. To view the library's module list and name table, specify the LIBRARY command with the /LIST and /NAMES qualifiers, as in the following example:

```
$ LIBRARY/LIST/NAMES MYMATH_LIB
Directory of ELF OBJECT library WORK:[PROGRAMS]MYMATH_LIB.OLB;1 on 8-MAR-2019 17:49:14
Creation date: 8-MAR-2019 17:48:57 Creator: Librarian I01-42
Revision date: 8-MAR-2019 17:48:57 Library format: 6.0
Number of modules: 1 Max. key length: 1024
Other entries: 4 Preallocated index blocks: 213
Recoverable deleted blocks: 0 Total index blocks used: 2
Max. Number history records: 20 Library history records: 0
Module MY_MATH
MYADD
MYDIV
MYMUL
MYSUB
```

You can specify the library in the link operation using the following command:

```
$ LINK/MAP/FULL/CROSS MY_MATH, MYMATH_LIB/LIBRARY
```

The map file produced by the link operation verifies that the object module MY_MATH.OBJ was included in the link operation.

2.2.3.1. Identifying Library Files Using the /LIBRARY Qualifier

When the linker processes a library file identified by the /LIBRARY qualifier, the linker processes the library's name table and looks for the definitions of symbols referenced in previously processed input files.

Note that in order to resolve a reference to a symbol defined in a library, the linker must first process the module that references the symbol *before* it processes the library file. As such, while the order of object modules and shareable images is not usually important in a link operation, how you order library files can be important. For more information about controlling the order in which the linker processes input files, see Section 2.3.

Once the object module or shareable image is included from the library into the link operation, the linker processes all the symbol definitions in a shareable image, and symbol definitions and references in an object module. If you want the linker to selectively process object modules or shareable images that are included in the link operation from a library, you must append the Librarian utility's /SELECTIVE_SEARCH qualifier to the file specification of the object module or shareable image when you insert it into the library. Appending the linker's /SELECTIVE_SEARCH qualifier to a library file specification in a link operation is illegal. For more information about processing input files selectively, see Section 2.2.4.

Processing Object Module Libraries

When the linker finds a symbol in the name table of an object module library, it:

- Extracts from the library the object module that contains the definition and includes it in the link operation
- Processes the GSD of the object module extracted from the library, adding an entry to the linker's list of symbol definitions for every symbol defined in the object module, and adding entries to the linker's undefined symbol list for all the symbols referenced by the module (see Section 2.2.1)
- Continues to process the undefined symbol list until there are no definitions in the library for any outstanding references

When the linker finishes processing the library, it will have extracted all the modules that resolve references generated by modules that were previously extracted from the library.

Processing Shareable Image Libraries

When the linker finds a symbol in the name table of a shareable image library, it notes which shareable image contains the symbol and then looks for the shareable image to include it in the link operation. By default, the linker looks for the shareable image in the same device and directory as the library file

If the linker cannot find the shareable image in the device and directory of the library file, the linker looks for the shareable image in the directory pointed to by the logical name `X86$LIBRARY` for x86-64 links and `IA64$LIBRARY` for I64 links.

Once the linker locates the shareable image, it processes the shareable image as it does any other shareable image (see Section 2.2.2).

2.2.3.2. Including Specific Modules from a Library Using the `/INCLUDE` Qualifier

If the library file is specified with the `/INCLUDE` qualifier, the linker *does not* process the library's name table. Instead, the linker includes in the link operation modules from the library specified with the `/INCLUDE` qualifier and processes these modules as it would any other object module or shareable image.

If you append both the `/LIBRARY` qualifier and the `/INCLUDE` qualifier to a library file specification, the linker processes the library's name table to search for modules that contain needed definitions. When the linker finds an object module or shareable image in the library that contains a needed definition, it processes it as described in Section 2.2.3.1. In addition, the linker includes the modules specified with the `/INCLUDE` qualifier in the link operation and processes them as it would any other object module or shareable image.

2.2.3.3. Processing Default Libraries

In addition to the libraries you specify using the `/LIBRARY` qualifier or the `/INCLUDE` qualifier, the linker processes certain other libraries by default. The linker processes these default libraries in the following order:

1. **Default user library files.** You specify a default user library by associating the library with one of the linker's default logical names from the range `LNK$LIBRARY`, `LNK$LIBRARY_1`, ... `LNK$LIBRARY_999`. If the `/NOUSERLIBRARY` qualifier is specified, the linker skips processing default user libraries. For more information about defining a default user library, see the description of the `/USERLIBRARY` qualifier in Chapter 10.

If the default user library contains shareable images, the linker looks for the shareable image as described in Section 2.2.3.1.

2. **Default system shareable image library file.** The linker processes the default system shareable image library `IMAGELIB.OLB` by default unless you specify the `/NOSYSSHR` or the `/NOSYSLIB` qualifier.

Note that when the linker needs to include a shareable image from `IMAGELIB.OLB` in a link operation, it always looks for the shareable images in `X86$LIBRARY` on x86-64 and `IA64$LIBRARY` on I64. The linker *does not* look for the shareable image in the device and directory of `IMAGELIB.OLB` as it does for other shareable image libraries.

3. **Default system object module library file.** The linker processes the default system object library `STARLET.OLB` by default unless you specify the `/NOSYSLIB` qualifier.

When the x86-64 or I64 linkers process `STARLET.OLB` by default, it also processes the shareable image (`SYSS$PUBLIC_VECTORS.EXE`). This shareable image is needed to resolve references to system services.

When `STARLET` is not processed by default (for example, when the `/NOSYSLIB` qualifier is specified), the linker does not process `SYSS$PUBLIC_VECTORS.EXE` automatically, even if you explicitly specify `STARLET.OLB` in an options file.

If you specify `SYSS$PUBLIC_VECTORS.EXE` explicitly in an options file when it is already being processed by default, the linker displays the following warning:

```
%ILINK-W-MULCLUOPT, cluster SYSS$PUBLIC_VECTORS multiply defined
in options file [filename]
```

2.2.4. Processing Input Files Selectively

By default, the linker processes all the symbol definitions and references in an object module or a shareable image specified as input in a link operation. However, if you append the `/SELECTIVE_SEARCH` qualifier to an input file specification, the linker processes from the input file only those symbol definitions that resolve references in previously processed input files.

Processing input files selectively can reduce the amount of time a link operation takes and can conserve the linker's use of virtual memory. Note, however, that selective processing can also introduce dependencies on the ordering of input files in the `LINK` command.

Note

Processing files selectively does not affect the size of the resultant image; the entire object module is included in the image even if only a subset of the symbols it defines is referenced. (Shareable images do not contribute to the size of an image).

For example, in the link operation in Section 2.2.2, the linker processes the shareable image `MY_MATH.EXE` before it processes the object module `MY_MAIN.OBJ` because of the way in which the linker clusters input files. (For information about how the linker clusters input files, see Section 2.3.1). When it processes the shareable image, the linker includes on its list of symbol definitions all the symbols defined in the shareable image. When it processes the object module `MY_MAIN.OBJ` and encounters the reference to the symbol `mysub`, the linker has the definition to resolve the reference.

If you append the `/SELECTIVE_SEARCH` qualifier to the shareable image file specification and all of the other input files are specified on the command line, the link will fail. In the following example, because the linker has no symbols on its undefined symbol list when it processes the shareable image file `MY_MATH.EXE`, it does not include any symbol definitions from the shareable image in its processing. When it subsequently processes the object module `MY_MAIN.OBJ` that references the symbol `mysub`, the linker cannot resolve the reference to the symbol. For information about how to correct this link operation, see Section 2.3.1.

```
$ LINK MY_MAIN, SYS$INPUT/OPT
MY_MATH.EXE/SHAREABLE/SELECTIVE_SEARCH
Ctrl/Z
%ILINK-W-NUDFSYMS, 1 undefined symbol:
%ILINK-I-UDFSYM,      MYSUB
%ILINK-W-USEUNDEF, undefined symbol MYSUB referenced
      section: $CODE$
      offset: %X00000000000000110 slot: 2
      module: MY_MAIN
      file: WORK:[PROGRAMS]MY_MAIN.OBJ;1
```

To process object modules or shareable images in a library selectively, you must specify the `/SELECTIVE_SEARCH` qualifier when you insert the module in the library. The following command creates the library `MYMATH_LIB.OLB` and inserts the file `MY_MATH.OBJ` into the library. For more information about using the Librarian utility, see the *VSI OpenVMS Command Definition, Librarian, and Message Utilities Manual*.

```
$ LIBRARY/CREATE/INSERT MYMATH_LIB MY_MATH/SELECTIVE_SEARCH
```

2.3. Ensuring Correct Symbol Resolution

For many link operations, the order in which the input files are specified in the `LINK` command is not important. However, in complex link operations that specify multiple library files or process input files selectively, correct symbol resolution may become problematic.

To ensure that the linker resolves all the symbolic references as you intend, you may need to know order in which the linker processes the input files. To control the order in which the linker processes input files, you must understand how the linker parses the command line. The following sections describe these processes.

2.3.1. Understanding Cluster Creation

As it parses the command line, the linker groups the input files you specify into **clusters** and places these clusters on a cluster list. A cluster is an internal linker construct that determines segment creation. The position of an input file in a cluster and the position of that cluster on the linker's cluster list determine the order in which the linker processes the input files you specify.

The linker always creates at least one cluster, called the **default cluster**. The linker may create additional clusters, called **named clusters**, depending on the types of input files you specify and the linker options you specify. If it creates additional clusters, the linker places them on the cluster list ahead of the default cluster, in the order in which it encounters them in the options file. The default cluster appears at the end of the cluster list. (Within the default cluster, input files appear in the same order in which they are specified on the `LINK` command line).

Clusters for shareable images, specified in shareable image libraries, appear *after* the default cluster on the cluster list because they are created later in linker processing, when the linker knows which shareable images in the library are needed for the link operation.

The linker groups input files into clusters according to file type. Table 2.2 lists the types of input files accepted by the linker and describes how the linker processes them when creating clusters.

Table 2.2. Linker Input File Cluster Processing

Input File	Cluster Processing
Object file (.OBJ)	Placed in the default cluster unless explicitly placed in a named cluster using the CLUSTER= option.
Shareable image file (.EXE)	Always placed in a named cluster.
Library files (.OLB)	Placed in the default cluster unless explicitly placed in a named cluster using the CLUSTER= option. If the library contains shareable images and the linker includes a shareable image from the library in the link operation, the linker creates a new cluster for the shareable image. The linker puts input files included in a link operation from a library using the /INCLUDE qualifier in the same cluster as the library. The linker puts modules extracted from any default user library that is an object library and from STARLET.OLB in the default cluster. However, the linker puts shareable images referenced from IMAGELIB.OLB into new clusters at the end of the cluster list (after the default cluster).
Options file (.OPT)	Not placed in a cluster.

The following example illustrates how the linker puts the various types of input files in clusters. To see which clusters the linker creates for this link operation, look at the Cluster Synopsis section of the image map file. Figure 2.4 illustrates the clusters created for this link operation. Note that order of cluster creation is: MY_CLUS, MY_SHARE, DEFAULT_CLUSTER, MY_SHARE_IMG.

```
$ DEFINE LNK$LIBRARY SYS$DISK:[ ]MY_DEFAULT_LIB.OLB
$ LINK MY_MAIN.OBJ, MY_LIB.OLB/LIBRARY, SYS$INPUT/OPT
CLUSTER=MY_CLUS, , MY_PROG.OBJ
MY_SHARE.EXE/SHAREABLE
MY_SHARE_LIB.OLB/LIBRARY
Ctrl/Z
```

Figure 2.4. Clusters Created for Sample Link

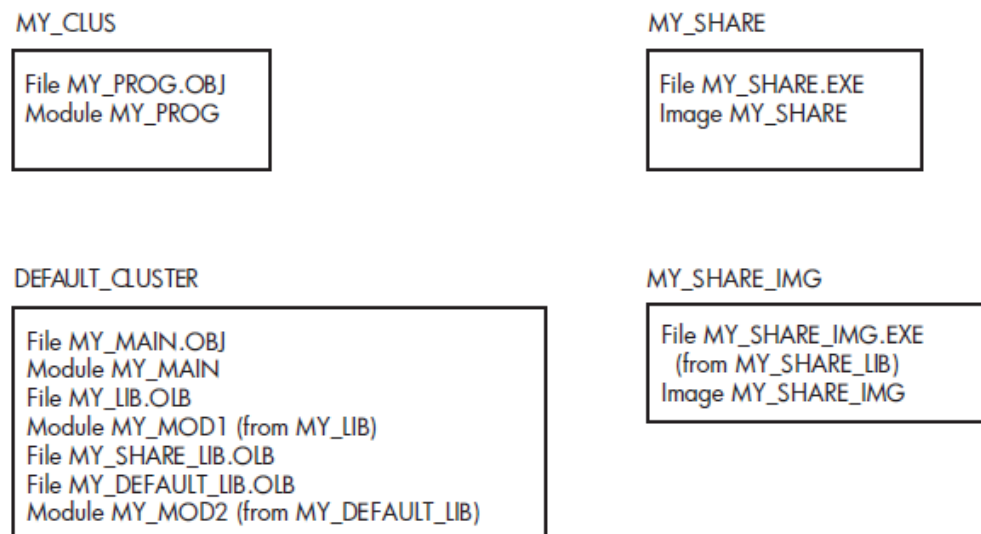

VM-1201A-AI

The linker processes input files in cluster order, processing each input file starting with the first file in the first cluster, then processing the second file, and so on, until it has processed all files in the first cluster. The linker continues processing the input files in the second, and subsequent, clusters in the same manner. Processing concludes when the linker has processed all files in all clusters.

2.3.2. Controlling Cluster Creation

You can control cluster creation and ordering by using either of the following linker options:

- CLUSTER= option
- COLLECT= option

2.3.2.1. Using the CLUSTER= Option to Control Clustering

The CLUSTER= option causes the linker to create a named cluster and to place, in the cluster, the object modules specified in the option. (The linker puts shareable images in their own clusters).

For example, you can use the CLUSTER= option to fix the link operation illustrated in Section 2.2.4, where the link operation yielded warnings because a shareable image was processed first and selectively. To make the linker process the object module MY_MAIN.OBJ before it processes the shareable image MY_MAIN.EXE, put the object module in a named cluster before specifying the shareable image. In the following example, the /EXECUTABLE qualifier is specified on the command line to specify the name of the resultant image, because MY_MAIN is not specified on the command line.

```
$ LINK/EXECUTABLE=MY_MAIN SYS$INPUT/OPT
CLUSTER=MYMAIN_CLUS,,,MY_MAIN
MY_MATH/SHAREABLE/SELECTIVE_SEARCH
Ctrl/Z
```

The Object and Image Synopsis section of the image map file verifies that the linker processed the object module MY_MAIN before it processed the shareable image MY_MATH, as in the following map file excerpt:

```

+-----+
! Object and Image Synopsis !
+-----+
Module/Image  File          Ident          Attributes          Bytes
-----
MY_MAIN      WORK:[PROGRAMS]MY_MAIN.OBJ;1
              V1.0              Lkg   Dnrm          504
MY_MATH      WORK:[PROGRAMS]MY_MATH.EXE;1
              V1.0              Sel Lkg              0
.
.
.
```

2.3.2.2. Using the COLLECT= Option to Control Clustering

You can also create a named cluster by specifying the COLLECT= option. The COLLECT= option directs the linker to put specific sections in a named cluster. The linker creates the cluster if it does not already exist. Note that the COLLECT= option manipulates sections, *not* input files.

The linker sets the global (GBL) attribute of the sections specified in a COLLECT= option to enable a global search for the definition of that section.

```
$ LINK/EXECUTABLE=MY_MAIN SYS$INPUT/OPT
CLUSTER=MYMAIN_CLUS , , MY_MAIN
COLLECT=MYCODE_CLUS , $CODE$
MY_MATH/SHAREABLE/SELECTIVE_SEARCH
Ctrl/Z
```

In this example, a cluster MYCODE_CLUS is created after MYMAIN_CLUS and the section \$CODE\$ is collected into the cluster MYCODE_CLUS.

2.4. Resolving Symbols Defined in the OpenVMS Executive

For x86-64 and I64 linking, you link against the OpenVMS executive by specifying the /SYSEXE qualifier. When this qualifier is specified, the linker selectively processes the system shareable image, SYS\$BASE_IMAGE.EXE, located in the directory pointed to by the logical name X86\$LOADABLE_IMAGES for x86-64 links and IA64\$LOADABLE_IMAGES for I64 links. The linker does not process SYS\$BASE_IMAGE.EXE by default. Note that, because the linker is processing a shareable image, references to symbols in the OpenVMS executive are fixed up at image activation.

When the /SYSEXE qualifier is specified, the linker processes the file selectively. To disable selective processing, specify the /SYSEXE=NOSELECTIVE qualifier and keyword. For more information about using the /SYSEXE qualifier, see the description of the qualifier in Chapter 10.

Relation to Default Library Processing

When you specify the /SYSEXE qualifier, the linker processes the SYS\$BASE_IMAGE.EXE file *after* processing the system shareable image library, IMAGELIB.OLB, and *before* processing the system object library, STARLET.OLB. (Note that the linker also processes the system service shareable image, SYS\$PUBLIC_VECTORS.EXE, when it processes STARLET.OLB by default).

The /SYSSHR and /SYSLIB qualifiers, which control processing of the default system libraries, do not affect SYS\$BASE_IMAGE.EXE processing. When the /NOSYSSHR qualifier is specified with the /SYSEXE qualifier, the linker does not process IMAGELIB.OLB, but still processes SYS\$BASE_IMAGE.EXE and then STARLET.OLB and SYS\$PUBLIC_VECTORS.EXE. When /NOSYSLIB is specified, the linker does not process IMAGELIB.OLB, STARLET.OLB, or SYS\$PUBLIC_VECTORS, but still processes SYS\$BASE_IMAGE.EXE.

To process SYS\$BASE_IMAGE.EXE before the shareable images in IMAGELIB.OLB, specify SYS\$BASE_IMAGE.EXE in a linker options file as you would any other shareable image. If you specify SYS\$BASE_IMAGE.EXE in your options file, do not use the /SYSEXE qualifier.

Figure 2.5 illustrates how the /SYSEXE qualifier, in combination with the /SYSSHR and /SYSLIB qualifiers, can affect linker processing. (The default syntax illustrated in the figure is rarely specified).

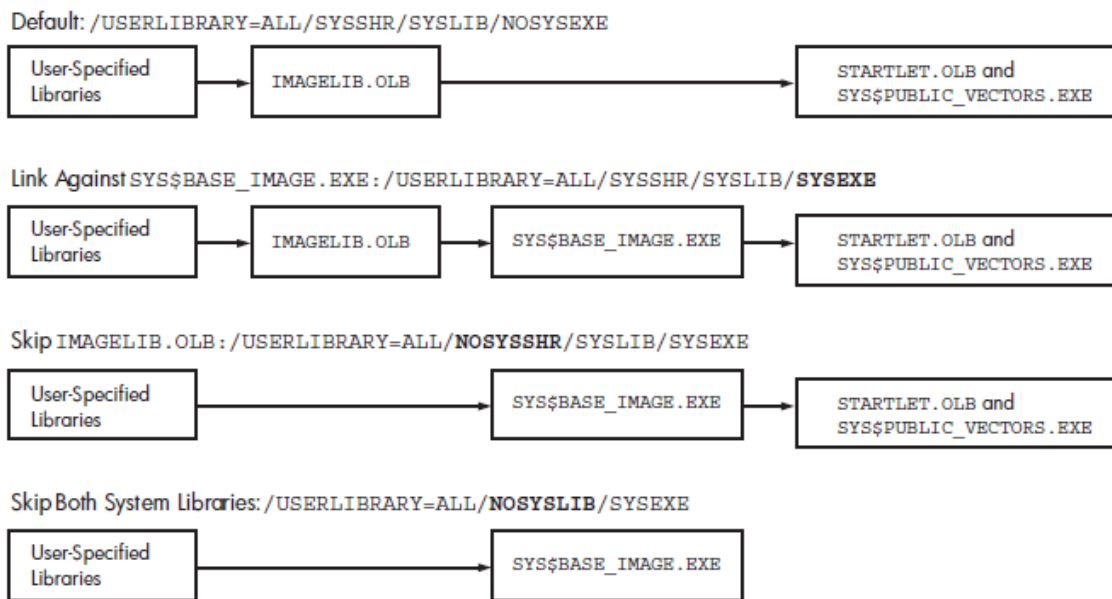
Figure 2.5. Linker Processing of Default Libraries and SYS\$BASE_IMAGE.EXE

VM-1202A-AI

2.5. Processing Weak and Strong Global Symbols

This section describes how the linker processes weak and strong global symbols.

2.5.1. Overview of Weak and Strong Global Symbol Processing

The linker records each symbol definition and each symbol reference in its internal global symbol table. For each symbol, the linker notes whether the symbol is strong, VMS-style weak, or UNIX-style weak.

The linker processes strong symbol definitions differently than it does UNIX-style weak symbol definitions (see Section 2.5.2). In general, a symbol can have only one strong or one VMS-style weak definition but it can have multiple UNIX-style weak definitions. When linking against libraries, note that there is also a difference between VMS-style weak and UNIX-style weak symbol definitions.

The linker processes weak references differently than it does strong references, although it handles both types of weak references in the same manner. Strong references must be resolved, whereas VMS-style and UNIX-style weak can be resolved optionally. If any weak symbol is not resolved, then the linker puts the value zero in place of the reference. In this case, the linker does not display a warning message.

By default, all global symbols generated by most x86-64 and I64 language processors are strong. That is, object modules usually contain strong symbol definitions and strong symbol references. You can decide to make some symbols VMS-weak definitions and references. To do so, you must use a language feature and explicitly mark the code or data as VMS-style weak. (For example, you would explicitly mark the code or data as VMS-style weak with the intention of performing a link operation on partially complete development code). See Section 2.5.1.2 for more information about creating and using VMS-style weak symbols.

For some language constructs, the VSI C++ compiler generates UNIX-style weak symbols. That is, some object modules may contain strong and weak symbol definitions and references. The compiler produces redundant code or data in multiple object modules and the linker resolves to the first symbol encountered in the link operation.

2.5.1.1. Strong Symbols

For strong global symbols, there can be only one definition. If the linker finds more than one definition in different input modules, any secondary definition is reported as a multiple definition.

By default, when adding an object module to a library, a strong symbol definition from the object module is included in the library symbol table. As a result, the symbol can be found when the linker searches a library to resolve a symbol reference.

2.5.1.2. VMS-Style Weak Symbols

VMS-style weak global symbols can have only one definition. If the linker finds more than one definition in different input modules, any secondary definition is reported as multiply defined.

When adding an object module to a library, a VMS-style weak global symbol is not included in the library symbol table. As a result, if the module containing the weak symbol definition is in a library but is not selected for inclusion (by means of the `/INCLUDE` qualifier or to resolve a strong reference), the linker is unable to resolve the reference.

2.5.1.3. UNIX-Style Weak Symbols

UNIX-style weak global symbols can have multiple definitions. When a strong definition is absent, the linker selects the first occurrence of the UNIX-style weak definition and views subsequent ones as references.

When adding an object module to a library, a UNIX weak symbol is included in the library symbol table. (The x86-64 and I64 Librarians are compatible with UNIX-style weak symbols). If multiple modules define the same UNIX-style weak symbol, the librarian maintains an ordered list of symbols in its symbol table. With this information, the linker can find a UNIX-style weak symbol when searching a library for an unresolved symbol. Note that the earliest module added in the library defining the symbol is selected for inclusion.

If the object module containing any type of weak symbol definition is explicitly specified, either as an input object file or for extraction from a library (by means of the `/INCLUDE` qualifier or to resolve a strong reference), the VMS-style weak or UNIX-style weak symbol definitions are available for symbol resolution.

2.5.2. Strong and Weak Definitions

The OpenVMS x86-64 and I64 linkers support modules from various programming languages and contain rules for handling symbols from these languages under different circumstances. Table 2.3 shows how symbol definitions are handled when object modules are processed.

Table 2.3. Symbol Definition Handling

Current Symbol Definition	New Symbol Definition Encountered	Action
<none>	<any>	Assign new definition
UNIX-style weak	UNIX-style weak	Ignore new definition
UNIX-style weak	VMS-style weak	Assign VMS-style weak definition
UNIX-style weak	Strong	Assign Strong definition
VMS-style weak	UNIX-style weak	Ignore new definition
VMS-style weak	VMS-style weak	Report multiple defined symbols
VMS-style weak	Strong	Report multiple defined symbols
Strong	UNIX-style weak	Ignore new definition
Strong	VMS-style weak	Report multiple defined symbols
Strong	Strong	Report multiple defined symbols

An exception to the rules presented in Table 2.3 is for the special symbol, `ELF$TFRADR`, which defines the image entry point. Typically, each compiler defines one symbol for each module that contains code. If the module contains a `main` entry, then a strong symbol is defined. Conversely, if there is no `main` entry, a VMS-style weak symbol is defined (which behaves differently than a strong symbol).

If you have only VMS-style weak `ELF$TFRADR` symbols, the first-encountered definition determines the image entry and the other definitions are ignored. If there is a strong definition, it overwrites an existing VMS-style weak definition and other definitions are ignored.

Note

This case is different than processing UNIX-style weak symbols, where ignored symbols are converted to references.

2.5.3. Resolving Strong and Weak Symbols

This section describes how the x86-64 and I64 linkers process strong and weak references to resolve symbols. In general, a strong reference can be resolved by a strong symbol definition or any type of weak symbol definition.

For a strong reference, the linker searches all input files (explicit and implicit) for a definition of the symbol. If the linker cannot locate the definition needed to resolve the strong reference, it reports the undefined symbol and assigns the symbol a value, which usually results in a run-time error for accessing the data or calling the routine.

When the linker resolves a weak reference with a strong symbol definition or a weak symbol definition, it resolves the weak reference in the same way it does a strong reference, with the following exceptions:

- The linker will not search library modules that have been specified with the `/LIBRARY` qualifier or default libraries (user-defined or system) solely to resolve a weak reference. If, however, the linker resolves a strong reference to another symbol in such a module, it will also use that module to resolve any weak references.

- If the linker cannot locate the definition needed to resolve a weak reference, it assigns the symbol a value, which usually results in a run-time error, but does not report an undefined symbol. If, however, the linker reports any unresolved strong references, it will also report any unresolved weak references.

By default, most global definitions in x86-64 and I64 languages are strongly defined.

2.5.4. Creating and Using VMS-style Weak Symbols

In the dialects of MACRO, BLISS, and Pascal supported on x86-64 and I64 systems, you can define a global symbol as either strong or VMS-style weak, and you can make either a strong or a VMS-style weak reference into a global symbol.

In these languages, all definitions and references are strong by default. To make a VMS-style weak definition or a VMS-style weak reference, you must use the `.WEAK` assembler directive (in MACRO), the `WEAK` attribute (in BLISS), or the `WEAK_GLOBAL` or `WEAK_EXTERNAL` attribute (in Pascal).

One purpose for making a weak reference is need to write and test incomplete programs. Resolving all symbolic references is crucial to a successful link operation. Therefore, a problem arises when the definition of a referenced global symbol does not yet exist. (This would be the case, for example, if the global symbol definition is an entry point to a module that is not yet written). The solution to this condition is to make the reference to the symbol VMS-style weak, which informs the linker that the resolution of this particular global symbol is not crucial to the link operation.

2.6. Processing VSI C++ Compiler-Generated UNIX-Style Weak and Group Symbols

UNIX-style weak symbols and groups are used by the VSI C++ compiler to implement template instantiation. Templates, commonly used in the VSI C++ standard library, provide a programming model that allows you to write and use data type-independent code. When this code is part of a source module, it is used with a data type, that is, the template is instantiated.

To instantiate the template, the compiler defines UNIX-style weak symbols for variables and functions used in the template and generates a group. All these symbols, along with code and data, are placed in the group and marked as group symbols. When the same template with the same data type is instantiated in several source modules, a group with the same name containing the same code and data appears in each object module.

The linker handles group symbols in a special way to generate an image which contains only one occurrence of this group of sections. The linker ensures that all references to the groups are resolved to the designated instance of the group.

Currently, UNIX-style weak symbols and group symbols are only used by the VSI C++ compiler, which also limits the usage of UNIX-style weak binding to group symbols. However, UNIX-style weak symbols and group symbols can be seen as independent, and the linker handles them as such.

2.6.1. Processing Group Symbols

When linking modules, the first occurrence of a group makes its symbols known to the linker. The linker regards any additional occurrence of the group with the same name as redundant and therefore, ignores it.

Because the concept of groups (as described in the ELF specification) is limited to object modules, the use of shareable images requires a different approach: the VMS extension to ELF allows groups for shareable images. A **shareable image group** always takes precedence over groups found in object modules. For global symbols and identical groups, this means that all group symbols from an already processed group of an object module are replaced by the ones from the shareable image. The linker's intention is to always use the code and data from the shareable image.

2.6.2. VSI C++ Examples

The following VSI C++ examples demonstrate how symbols are resolved when you link with compiler-generated UNIX-style weak and group symbols.

The examples apply a user-written function template called `myswap`. Note that you can also use class templates, which are implemented in a similar manner. If you are an experienced C++ programmer, you will also recognize that there is a "swap" function in the VSI C++ standard library, which you should use instead of writing your own function.

In the examples, the compiler combines code sections (and other required data) into a group, giving it a unique group name derived from the template instantiation.

The linker includes the first occurrence of this group in the image. All UNIX-style weak definitions obtained from that group are now defined by the module providing this group. All subsequent groups with the same name do not contribute code or data; that is, the linker ignores all subsequent sections. The UNIX-style weak definitions from these ignored sections become references, which are resolved by the definition from the designated instance (that is, first-encountered instance) of the group. In this manner, code (and data) from templates are included only once for the image.

Example 2.3 shows UNIX-Style weak symbols and group symbols.

Example 2.3. UNIX-Style Weak and Group Symbols

```
// file: my_asc.cxx
template <typename T> ❶
void myswap (T &v1, T &v2) { ❷
    T tmp;
    tmp = v1;
    v1 = v2;
    v2 = tmp;
}
void ascending (int &v1, int &v2) {
    if (v2<&v1)
        myswap (v1,v2); ❸
}
// file: my_desc.cxx
template <typename T> ❶
void myswap (T &v1, T &v2) { ❷
    T tmp;
    tmp = v1;
    v1 = v2;
    v2 = tmp;
}
void descending (int &v1, int &v2) {
    if (v1<&v2)
        myswap (v1,v2); ❸
}
// file: my_main.cxx
#include <cstdlib>
#include <iostream>
using namespace std;
static int m = 47;
```

```

static int n = 11;
template <typename T> void myswap (T &v1, T &v2);
extern void ascending (int &v1, int &v2);
extern void descending (int &v1, int &v2);
int main (void) {
    cout << "original: " << m << " " << n << endl;
    myswap (m,n); ❹
    cout << "swapped: " << m << " " << n << endl;
    ascending (m,n);
    cout << "ascending: " << m << " " << n << endl;
    descending (m,n);
    cout << "descending: " << m << " " << n << endl;
    return EXIT_SUCCESS;
}

```

Example 2.4 shows the compile and link commands.

Example 2.4. Compile and Link Commands

```

$ CXX/OPTIMIZE=NOINLINE/STANDARD=STRICT_ANSI MY_MAIN ❶
$ CXX/OPTIMIZE=NOINLINE/STANDARD=STRICT_ANSI MY_ASC ❷
$ CXX/OPTIMIZE=NOINLINE/STANDARD=STRICT_ANSI MY_DESC ❷
$ CXXLINK MY_MAIN, MY_ASC, MY_DESC ❸

```

In the examples, the compiler combines code sections (and other required data) into a group, giving it a unique group name derived from the template instantiation.

The linker includes the first occurrence of this group in the image. All UNIX-style weak definitions obtained from that group are now defined by the module providing this group. All subsequent groups with the same name do not contribute code or data; that is, the subsequent sections are ignored. The UNIX-style weak definitions from these ignored sections become references, which are resolved by the definition from the designated instance (first-encountered) of the group. In this manner, code (and data) from templates are included only once for the image.

- ❶ To keep the examples simple, the template definitions are included in the sources, usually templates are defined in include files.
 - ❷ C++ mangles symbol names to guarantee unique names for overloaded functions. Therefore, in the linker map or in the output from ANALYZE/OBJECT utility, the string MY_SWAP may be part of a longer symbol name and may not be easily identified. Further, the compiler creates more names using the string MY_SWAP:the unique group name, code section names, and so on.
 - ❸ The functions "ascending" and "descending" sort a pair of numbers. If necessary the contents are swapped. Swapping is implemented as a function template, which is automatically instantiated with the call inside of the functions "ascending" and "descending".
 - ❹ In the main function, "myswap" is used to demonstrate a strong reference to a UNIX-style weak definition. (As previously mentioned, this is not common practice. Usually, templates are defined in include files and included in all sources). Note that there is only a reference to the function and that there is no definition. That is, the compiler does not create a group. When compiling the main module, a reference to "myswap <int>" is automatically generated for the call to myswap inside the main function. This strong reference will be resolved by the first UNIX-style weak definition from either MY_ASC.OBJ or MY_DESC.OBJ which define "myswap <int>".
- ❶ To see the effects of this example, the compiler should not inline code. Because inlining is an optimization, this feature is demonstrated only by omitting optimization.
 - ❷ When both source modules are compiled, both object modules contain the definition of the "myswap <int>" function. The compiler groups the code (and other required data) sections into a group with a unique group name derived from the template instantiation. The compiler generates UNIX-style weak symbols and adds them to the group.

- ③ For linking, the CXXLINK command is used in the examples. This command invokes the C++ linker driver, which in turn calls the OpenVMS linker to perform the actual link operation.

2.6.3. Compiler-Generated Symbols and Shareable Images

To create a VMS shareable image, you must define the interface in a symbol vector at link time with a `SYMBOL_VECTOR` option. VSI C++ generated objects contain mangled symbols and may contain compiler-generated data, which belongs to a public interface. In the `SYMBOL_VECTOR` option, the interface is describe with the names from the object modules. Because they contain mangled names, such a relationship may not be obvious from the source code and the symbols as seen in an object module.

If you do not export all parts of an interface, code that is intended to update one data cell may be duplicated in the executable and the shareable image along with the data cell. That is, data can become inconsistent at run-time, producing a severe error condition. This error condition can not be detected at link time nor at image activation time. Conversely, if you export all symbols from an object module, you may export the same symbol which is already public from other shareable images.

A conflict arises when an application is linked with two shareable images that export the same symbol name. In this case, the linker flags the multiple definitions with a `MULDEF` warning that should not be ignored. This type of error most often results when using templates defined in the C++ standard library but instantiated by the user with common data types. Therefore, VSI recommends that you only create a shareable image when you know exactly what belongs to the public interface. In all other cases, use object libraries and let applications link against these libraries.

The VSI C++ run-time library contains pre-instantiated templates. The public interfaces for these are known and therefore, the VSI C++ run-time library ships as a shareable image. The universal symbols from the VSI C++ run-time library and the group symbols take precedence over user instantiated templates with the same data types. As with other shareable images, this design is upwardly compatible and does not require you to recompile or relink to make use of the improved VSI C++ run-time library.

2.7. Understanding and Fixing DIFTYPE and RELODIFTYPE Linker Conditions (I64 Only)

On OpenVMS I64 systems, if a module defines a variable as data (`OBJECT`), it must be referenced as data by all other modules. If a module defines a variable as a procedure (`FUNC`), it must be referenced as a procedure by all other modules.

When data is referenced as a procedure, the linker displays the following informational message:

```
%ILINK-I-DIFTYPE, symbol symbol-name of type OBJECT cannot be
referenced as type FUNC
```

When a procedure is referenced as data, the following informational message is displayed:

```
%ILINK-I-DIFTYPE, symbol symbol-name of type FUNC cannot be
referenced as type OBJECT
```

Type checking is performed by the linker on OpenVMS I64 because the linker must create function descriptors. The equivalent procedure descriptor was created by the compiler on OpenVMS Alpha, so this informational message is new for the linker on OpenVMS I64.

This message is informational only and does not require user action. However, if the linker detects data referenced as a procedure, it might issue the following warning message in addition to the DIFTYPE message:

```
%ILINK-W-RELODIFTYPE, relocation requests the linker to build a
function descriptor for a non-function type of symbol
```

The following example of two modules demonstrates how to fix these conditions:

```
TYPE1.C
#include <stdio>
int status ; // Defines status as data.
extern int sub();
main ()
{
    printf ("Hello World\n");
    sub();
}
TYPE2.C
extern int status (int x) ; // Refers to status as a procedure.
sub ()
{
    int x;
    x = (int)status;
    return status (x);
}
```

When these modules are linked, you get an informational message and a warning message, as follows:

```
$ CC/EXTERN_MODEL=STRICT_REFDEF TYPE1
$ CC/EXTERN_MODEL=STRICT_REFDEF TYPE2
$ LINK TYPE1,TYPE2
%ILINK-I-DIFTYPE, symbol STATUS of type OBJECT cannot be referenced as
type FUNC
    module: TYPE2
    file: NODE1$:[SMITH]TYPE2.OBJ;6
%ILINK-W-RELODIFTYPE, relocation requests the linker to build a
function descriptor for a non-function type of symbol
    symbol: STATUS
    relocation section: .rela$CODE$ (section header entry: 18)
    relocation type: RELAS$K_R_IA_64_LTOFF_FPTR22
    relocation entry: 0
    module: TYPE2
    file: NODE1$:[SMITH]TYPE2.OBJ;6
```

To correct the problem and avoid the informational and warning messages, correct TYPE1.C to define status as a procedure:

```
TYPE1.C
#include <stdio>
int status (int x); // Defines status as a procedure.
extern int sub();
main ()
{
    printf ("Hello World\n");
    sub();
}
nt status (int x) {
    return 1;
}
$ CC/EXTERN_MODEL=STRICT_REFDEF TYPE1
$ CC/EXTERN_MODEL=STRICT_REFDEF TYPE2
$ LINK TYPE1,TYPE2
```

Chapter 3. Understanding Image File Creation (x86-64 and I64)

This chapter describes how the linker creates an image on OpenVMS x86-64 and OpenVMS I64 systems. The linker creates images from the input files you specify in a link operation. You can control image file creation by using linker qualifiers and options.

3.1. Overview

After the linker has resolved all symbolic references between the input files specified in the LINK command (described in Chapter 2), the linker knows all the object modules and shareable images that are required to create the image. For example, the linker has extracted from libraries specified in the LINK command those modules that contain the definitions of symbols required to resolve symbolic references in other modules. The linker must now combine all these modules into an image.

To create an image, the linker must perform the following processing:

- **Determine the memory requirements of the image**

The memory requirements of an image are the sum of the memory requirements of each object module included in the link operation, together with the memory the linker created to support code and data. The language processors that create the object modules specify the memory requirements of an object module as **section** definitions. A section represents an area of memory that has a name, a length, and other characteristics, called **attributes**, which describe the intended or permitted usage of that portion of memory. Section 3.2 describes sections.

The linker processes the section definitions in each object module, combining sections with similar attributes into a **segment**, which on x86-64 and I64 systems is analogous to an image section on Alpha and VAX systems (see Chapter 7). Each segment specifies the size and attributes of a portion of the virtual memory of an image. The image activator uses the segment attributes to determine the characteristics of the physical memory pages into which it loads the image, such as protection.

Figure 3.1 illustrates how memory requirements are communicated from the language processor to the linker and from the linker to the image activator. Section 3.3 provides more information about this process.

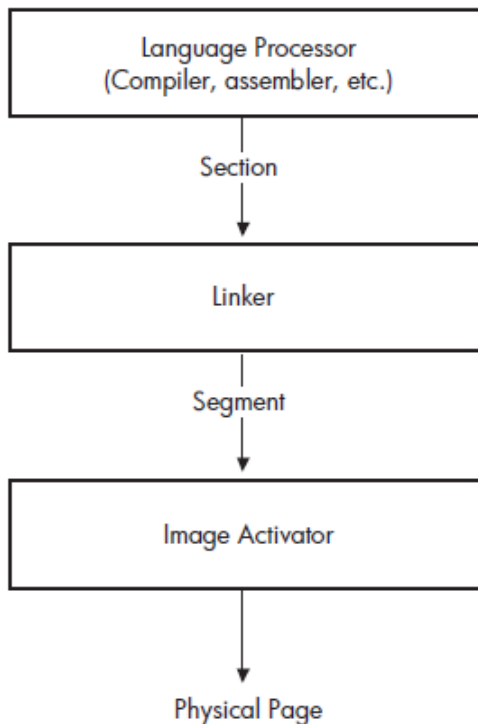
Figure 3.1. Communication of Image Memory Requirements on x86-64/I64

VM-1195A-AI

Note that shareable images included in link operations have already been processed by the linker. These images are separate images with their own memory requirements, as specified by their own segments. The image activator activates these shareable images at run-time.

- **Initialize the image**

When segments are first created, they are empty. In this step of linker processing, the linker copies the code and data sections from the object modules into the image's segments. Section 3.4 provides more information about this process.

In the process of initializing the image, the linker may encounter sections that have the type `SHT_NOBITS`. This section type indicates that the section occupies no space in the file — a **demand-zero** section. The linker combines these sections together into demand-zero segments. The linker also trims the zeros off the end of segments when the qualifier `/DEMAND_ZERO=PER_PAGE` is used. Note that this is not the default. The operating system initializes demand-zero segments at run-time, when a reference to a segment requires the operating system to move the pages into memory. Section 3.4.4 describes how the linker creates demand-zero segments.

After creating segments and filling them with binary code and data, the linker writes the image to an image file. Section 3.4.2 describes this process.

3.2. Creating Sections

Language processors create sections and define their attributes. The number of sections created by a language processor and the attributes of these sections are depend on language semantics. For example, some programming languages implement global variables as separate sections with a

particular set of attributes. Programmers working in high-level languages typically have little direct control over the sections created by the language processor. Medium- and low-level languages provide programmers with more control over section creation. For more information about the section creation features of a particular programming language, see the language processor documentation.

The x86-64 and I64 linkers also create sections that are combined with the compiler sections to create segments (see Section 3.2.1).

Section Attributes

The language processors define the attributes of the sections they create and communicate these attributes to the linker in the section header table.

Section attributes define various characteristics of the area of memory described by the section, such as the following:

- **Access**

Using section attributes, compilers can prohibit some types of access, such as write access. Using other section attributes, compilers can allow access to the section by more than one process.

- **Positioning**

By specifying certain section attributes, compilers can specify to the linker how it should position the section in memory.

Section attributes are Boolean values, that is, they are either on or off. Table 3.2 lists all section attributes with the keyword you can use to set or clear the attribute, using the `PSECT_ATTR=option`. For more information about using the `PSECT_ATTR=` option, see Section 3.3.7.

For example, to specify that a section should have write access, specify the writability attribute as `WRT`. To turn off an attribute, specify the negative keyword. Some attributes have separate keywords that express the negation of the attribute. For example, to turn off the global attribute (`GBL`), you must specify the local attribute (`LCL`). Note that the alignment of a section is not strictly considered an attribute of the section. However, because you can set it using the `PSECT_ATTR=` option, it is included in the table.

To be compatible with Alpha and VAX linkers, the x86-64 and I64 linkers retain the user interfaces as much as possible. This information includes the traditional OpenVMS section attribute names (`WRT`, `EXE`, and so on) that are used in the `PSECT_ATTR=` option. However, on x86-64 and I64 systems, the underlying object conforms to the ELF standard. When processing the object module, the linker maps the ELF terms to the OpenVMS terms. For compatibility, only OpenVMS terms are written to the map file. In contrast, other tools, such as the `ANALYZE/OBJECT` utility, do not use OpenVMS terms; they simply format the contents of the object file and therefore display the ELF terms.

Table 3.1 provides mapping between the ELF names and the traditional OpenVMS section attribute names.

Table 3.1. Mapping ELF Section Terms to OpenVMS Attributes

ELF Section Attribute (prefix <code>SHDR\$V_</code>)	Traditional OpenVMS Section Attribute
<code>SHF_WRITE</code>	<code>WRT</code>
<code>SHF_EXECINSTR</code>	<code>EXE</code>
<code>SHF_VMS_GLOBAL</code>	<code>GBL</code>

ELF Section Attribute (prefix SHDR\$V_)	Traditional OpenVMS Section Attribute
SHF_VMS_OVERLAID	OVR
___ ¹	REL
SHF_VMS_SHARED	SHR
SHF_VMS_VECTOR	VEC
SHF_VMS_ALLOC_64BIT	ALLOC_64BIT
SHF_X86_64_LARGE ²	—
SHF_IA_64_SHORT ³	SHORT
SHT_NOBITS ⁵	NOMOD ⁶

¹All ELF sections are relative (REL). There is only a conceptual absolute section: the reserved section number SHDR\$K_SHN_ABS. Absolute symbols are defined by that mechanism.

²x86-64 specific

³I64 specific

⁵This is an ELF section type (prefixed with SHDR\$K_), mapped to an OpenVMS section attribute.

⁶SHT_NOBITS/NOMOD is only set by compilers; it reflects uninitialized data.

Table 3.2 lists all section attributes with the keyword you can use to set or clear the attribute, using the PSECT_ATTR=option.

Table 3.2. Section Attributes on x86-64/I64

Attribute	Keyword	Description																														
Alignment	—	Specifies the alignment of the section as an integer that represents the power of 2 required to generate the desired alignment. For certain alignments, the linker supports keywords to express the alignment. The following table lists all the alignments supported by the linker with their keywords:																														
		<table border="1"> <thead> <tr> <th>Power of 2</th> <th>Keyword</th> <th>Meaning</th> </tr> </thead> <tbody> <tr> <td>0</td> <td>BYTE</td> <td>Alignment on byte boundaries.</td> </tr> <tr> <td>1</td> <td>WORD</td> <td>Alignment on word boundaries.</td> </tr> <tr> <td>2</td> <td>LONG</td> <td>Alignment on longword boundaries.</td> </tr> <tr> <td>3</td> <td>QUAD</td> <td>Alignment on quadword (8-byte) boundaries.</td> </tr> <tr> <td>4</td> <td>OCTA</td> <td>Alignment on octaword (16-byte) boundaries.</td> </tr> <tr> <td>5</td> <td>HEXA</td> <td>Alignment on hexadecimal word (32-byte) boundaries.</td> </tr> <tr> <td>6</td> <td>—</td> <td>Alignment on 64-byte boundaries.</td> </tr> <tr> <td>7</td> <td>—</td> <td>Alignment on 128-byte boundaries.</td> </tr> <tr> <td>8</td> <td>—</td> <td>Alignment on 256-byte boundaries.</td> </tr> </tbody> </table>	Power of 2	Keyword	Meaning	0	BYTE	Alignment on byte boundaries.	1	WORD	Alignment on word boundaries.	2	LONG	Alignment on longword boundaries.	3	QUAD	Alignment on quadword (8-byte) boundaries.	4	OCTA	Alignment on octaword (16-byte) boundaries.	5	HEXA	Alignment on hexadecimal word (32-byte) boundaries.	6	—	Alignment on 64-byte boundaries.	7	—	Alignment on 128-byte boundaries.	8	—	Alignment on 256-byte boundaries.
		Power of 2	Keyword	Meaning																												
		0	BYTE	Alignment on byte boundaries.																												
		1	WORD	Alignment on word boundaries.																												
		2	LONG	Alignment on longword boundaries.																												
		3	QUAD	Alignment on quadword (8-byte) boundaries.																												
		4	OCTA	Alignment on octaword (16-byte) boundaries.																												
		5	HEXA	Alignment on hexadecimal word (32-byte) boundaries.																												
		6	—	Alignment on 64-byte boundaries.																												
7	—	Alignment on 128-byte boundaries.																														
8	—	Alignment on 256-byte boundaries.																														

Attribute	Keyword	Description	
		9	— Alignment on 512-byte boundaries.
		13	— Alignment on 8 KB boundaries.
		14	— Alignment on 16 KB boundaries.
		15	— Alignment on 32 KB boundaries.
		16	— Alignment on 64 KB boundaries.
		—	PAGE Alignment on the default target page size, which is 64 KB for x86-64 and I64 linking. You can override this default by specifying the /BPAGE qualifier.
Position Independence	PIC/NOPIC	This keyword is ignored by the x86-64 and I64 linkers.	
Overlaid/Concatenated	OVR/CON	When set to OVR, specifies that the linker will overlay this section with other sections with the same name and attribute settings. Sections that are overlaid are assigned the same base address. When set to CON, the linker concatenates the sections.	
Relocatable/Absolute	REL/ABS	When set to REL, specifies that the linker can place the section anywhere in virtual memory. Absolute sections are used by compilers primarily to define constants, but in the ELF object language they are not put into an actual section. Setting the section to ABS on x86-64 and I64 is not meaningful, and the ABS keyword is ignored by the x86-64 and I64 linkers.	
Global/Local	GBL/LCL	When set to GBL, specifies that the linker should gather contributions to the section <i>from all clusters</i> and place them in the same segment. When set to LCL, the linker gathers sections into the same segment only if they are in the same cluster. The memory for a global section is allocated in the cluster that contains the first contributing module.	
Shareability	SHR/NOSHR	Specifies that the section can be shared between several processes. Only used to sort sections in shareable images.	
Executability	EXE/NOEXE	Specifies that the section contains executable code.	
Writability	WRT/NOWRT	Specifies that the contents of a section can be modified at run-time.	
Protected Vectors	VEC/NOVEC	Specifies that the section contains privileged change-mode vectors or message vectors. In shareable images, segments with the VEC attribute are automatically protected.	

Attribute	Keyword	Description
Solitary	SOLITARY	Specifies that the linker should place this section in its own segment. Useful for programs that map data into specific locations in their virtual memory space. Note that compilers do not set this attribute. You can set this attribute using the PSECT_ATTR=option.
Unmodified	NOMOD/MOD	When set, specifies that the section has not been initialized (NOMOD). The x86-64 and I64 linkers use this attribute to create demand zero segments (see Section 3.4.4). Only compilers can set this attribute (in ELF objects, the section type SHT_NOBITS). You can clear this attribute only by specifying the MOD keyword in the PSECT_ATTR= option.
Readability	RD	This keyword is ignored by the x86-64 and I64 linkers.
User/Library	USR/LIB	This keyword is ignored by the x86-64 and I64 linkers.
Short Data ¹	SHORT	When set this indicates that a data section should be put in one of the short sections. Compilers can set this attribute, in which case the user can not alter it.
Allocate section in P2 space	ALLOC_64BIT/ NOALLOC_64BIT	When set this indicates that the section should be allocated in P2 space instead of P0 space. The program may run but not execute correctly when initialized data is put in P2 space. Code and demand zero data do work properly.

¹I64 specific

To illustrate section creation, consider the sections created by the VSI C compiler when it processes the sample programs in the following examples:

Example 3.1. Sample Program MYTEST.C

```
#include <stdio.h>
extern int global_data;
extern int myadd( int, int );
extern int mysub( int, int );
main()
{
    int num1, num2, res1, res2;
    num1 = 5;
    num2 = 6;
    res1 = myadd( num1, num2 );
    res2 = mysub( num1, num2 );
    printf( "res1 = %d, res2 = %d, globaldata = %d\n", res1, res2, global_data );
}
```

Example 3.2. Sample Program MYADD.C

```
#include <stdio.h>
int add_data = -1;
int myadd( int value_1, int value_2 )
{
    printf( "In MYADD.C\n" );
    add_data = value_1 + value_2;
    return add_data;
}
```

Example 3.3. Sample Program MYSUB.C

```
#include <stdio.h>
int global_data = 5;
int sub_data = -1;
int mysub( int value_1, int value_2 )
{
    printf( "In MYSUB.C\n" );
    sub_data = value_1 - value_2;
    return sub_data;
}
```

To see what sections the VSI C compiler creates for these modules, use the ANALYZE/OBJECT utility to examine each object module. Example 3.4 (x86-64) and Example 3.5 (I64) present excerpts from the analysis of the object module MYTEST.OBJ. Only the section definitions are included in the excerpts.

Example 3.4. Sections Generated by an Analysis of Example 3.1 on x86-64

```
$ anal/object/section=all/out=mytest.anl mytest.obj
```

```
.
.
SECTION SUMMARY
```

Number	Type	Name	Flags
0.	NULL		-----
1.	PROGBITS	.text	-AE-----
2.	PROGBITS	.data	WA-----
3.	NOBITS	.bss	WA-----
4.	NOTE	.note	-----
5.	PROGBITS	.debug_info	-----
6.	RELA	.rela.debug_info	-----
7.	PROGBITS	.debug_abbrev	-----
8.	PROGBITS	.debug_aranges	-----
9.	PROGBITS	.debug_macinfo	-----
10.	PROGBITS	.debug_line	-----
11.	RELA	.rela.debug_line	-----
12.	PROGBITS	.debug_loc	-----
13.	PROGBITS	.debug_pubnames	-----
14.	RELA	.rela.debug_pubnames	-----
15.	PROGBITS	.debug_pubtypes	-----
16.	RELA	.rela.debug_pubtypes	-----
17.	PROGBITS	.debug_str	---S-----
18.	PROGBITS	.debug_ranges	-----
19.	PROGBITS	\$.CODE\$	-AE-----Shr-----
20.	RELA	.rela\$.CODE\$	-----
21.	PROGBITS	.rodata	-A-----
22.	PROGBITS	.note.GNU-stack	-----
23.	PROGBITS	.eh_frame	-A-----
24.	RELA	.rela.eh_frame	-----
25.	STRTAB	.shstrtab	-----
26.	SYMTAB	.symtab	-----
27.	STRTAB	.strtab	-----

Key for Flags: W (Write), A (Alloc), E (Execute), S (Strings), I (Info link), L (Link order),
 O (OS-specific processing), G (Group), Lrg (Large), Sho (Short), Nrc (No recovery code),
 Gbl (Global), Ovr (Overlaid), Shr (Shared), Vec (Vector), 64b (Allocate 64bit address),
 Pro (Protected)

```
.
.
.
```

```
SECTION HEADER ENTRY 19. (0013)
```

```
"$.CODE$"
```

Description	Hex (<bitmask>)	Interpretation	Field Name
Name Offset in .shstrtab:	000000FA	\$.CODE\$ ②	shdr\$l_sh_name
Section Type:	00000001	SHDR\$K_SHT_PROGBITS	shdr\$l_sh_type
Section Flags: ③	0000000000400006		shdr\$q_sh_flags
Data occupies memory:	<0000000000000002>	SHDR\$M_SHF_ALLOC	shdr\$v_shf_alloc

```

Machine instructions: <0000000000000004> SHDR$M_SHF_EXECINSTR      shdr$v_shf_execinstr
Shareable section:   <0000000000400000> SHDR$M_SHF_VMS_SHARED_    shdr$v_shf_vms_shared_
Section Load Address: 0000000000000000 Not Used (Object File)  shdr$pq_sh_addr
Offset to Section Data: 000000000000001B0      shdr$q_sh_offset
Size of Section Data: 0000000000000163      ④      shdr$q_sh_size
Section Link Field:   00000000      shdr$l_sh_link
Section Info Field:   00000000      shdr$l_sh_info
Alignment Constraint: 0000000000000010      ⑤      shdr$q_sh_addralign
Entry Size (if table): 0000000000000000      shdr$q_sh_entsize

```

SECTION HEADER ENTRY 23. (0017)

".eh_frame"

Description	Hex (<bitmask>)	Interpretation	Field Name
Name Offset in .shstrtab:	000000B8	".eh_frame"	shdr\$l_sh_name
Section Type:	00000001	SHDR\$K_SHT_PROGBITS	shdr\$l_sh_type
Section Flags:	0000000000000002		shdr\$q_sh_flags
Data occupies memory:	<0000000000000002>	SHDR\$M_SHF_ALLOC	shdr\$v_shf_alloc
Section Load Address:	0000000000000000	Not Used (Object File)	shdr\$pq_sh_addr
Offset to Section Data:	00000000000000340		shdr\$q_sh_offset
Size of Section Data:	00000000000000058		shdr\$q_sh_size
Section Link Field:	00000000		shdr\$l_sh_link
Section Info Field:	00000000		shdr\$l_sh_info
Alignment Constraint:	0000000000000008		shdr\$q_sh_addralign
Entry Size (if table):	0000000000000000		shdr\$q_sh_entsize

Example 3.5. Sections Generated by an Analysis of Example 3.1 on I64

```
$ anal/object/section=all/out=mytest.anl mytest.obj
```

```

.
.
SECTION SUMMARY

```

Number	Type	Name	Flags
0.	NULL		-----
1.	STRTAB	.shstrtab	-----
2.	NOTE	.note	-----
3.	PROGBITS	\$.CODE\$	-AE-----Shr-----
4.	PROGBITS	\$.LITERAL\$	-A-----Shr-----
5.	NOBITS	\$.LINK\$	-A-----
6.	PROGBITS	.IA_64.unwind_info	-A-----
7.	IA_64_UNWIND	.IA_64.unwind	-A---L----- ①
8.	STRTAB	.strtab	-----
9.	SYMTAB	.syntab	-----
10.	VMS_TRACE	.debug_line	-----
11.	RELA	.rela.debug_line	-----
12.	VMS_TRACE	.trace_abbrev	-----
13.	VMS_TRACE	.trace_info	-----
14.	RELA	.rela.trace_info	-----
15.	VMS_TRACE	.trace_aranges	-----
16.	RELA	.rela.trace_aranges	-----
17.	RELA	.rela.IA_64.unwind_info	-----
18.	RELA	.rela.IA_64.unwind	-----
19.	RELA	.rela\$.CODE\$	-----

Key for Flags: W (Write), A (Alloc), E (Execute), S (Strings), I (Info link), L (Link order), O (OS-specific processing), G (Group), Sho (Short), Nrc (No recovery code), Gbl (Global), Ovr (Overlaid), Shr (Shared), Vec (Vector), 64b (Allocate 64bit address), Pro (Protected)

SECTION HEADER ENTRY 3. (0003)

".CODE\$"

Description	Hex (<bitmask>)	Interpretation	Field Name
Name Offset in .shstrtab:	00000011	".CODE\$" ②	shdr\$l_sh_name

```

Section Type:                00000001  SHDR$K_SHT_PROGBITS          shdr$l_sh_type
Section Flags: ③            0000000400000006          shdr$q_sh_flags
  Data occupies memory:    <0000000000000002> SHDR$M_SHF_ALLOC            shdr$v_shf_alloc
  Machine instructions:    <0000000000000004> SHDR$M_SHF_EXECINSTR       shdr$v_shf_execinstr
  Shareable section:      <0000000400000000> SHDR$M_SHF_VMS_SHARED      shdr$v_shf_vms_shared
Section Load Address:      0000000000000000  Not Used (Object File)     shdr$pq_sh_addr
Offset to Section Data:    0000000000000170          shdr$q_sh_offset
Size of Section Data:      00000000000001C0  ④                          shdr$q_sh_size
Section Link Field:        00000000          shdr$l_sh_link
Section Info Field:        00000000          shdr$l_sh_info
Alignment Constraint:      0000000000000010  ⑤                          shdr$q_sh_addralign
Entry Size (if table):    0000000000000000          shdr$q_sh_entsize
.
.
SECTION HEADER ENTRY 7. (0007)
".IA_64.unwind"
Description                Hex (<bitmask>)  Interpretation              Field Name
-----
Name Offset in .shstrtab:   0000003C          ".IA_64.unwind"           shdr$l_sh_name
Section Type:              70000001          SHDR$K_SHT_IA_64_UNWIND   shdr$l_sh_type
Section Flags:             0000000000000082          shdr$q_sh_flags
  Data occupies memory:    <0000000000000002> SHDR$M_SHF_ALLOC            shdr$v_shf_alloc
  Preserve section order:  <0000000000000080> SHDR$M_SHF_LINK_ORDER     shdr$v_shf_link_order
Section Load Address:      0000000000000000  Not Used (Object File)     shdr$pq_sh_addr
Offset to Section Data:    0000000000000090          shdr$q_sh_offset
Size of Section Data:      0000000000000030          shdr$q_sh_size
Section Link Field: ①      00000003          shdr$l_sh_link
Section Info Field: ①      00000006          shdr$l_sh_info
Alignment Constraint:      0000000000000008          shdr$q_sh_addralign
Entry Size (if table):    0000000000000000          shdr$q_sh_entsize

```

Note

You can also determine the sections in an object module *after* a link operation by looking at the Program Section Synopsis of an image map file, as illustrated in Example 3.8.

The items in the following list correspond to the numbered items in Example 3.4 and Example 3.5:

- ① The unwind table section is the only section with the Link Order attribute set. The Link Order attribute signifies that the I64 linker must preserve section ordering (see Section 3.2.1.5).
- ② The Name Offset indicates the name of the section.
- ③ Section flags indicate which section attributes are set. The attributes are listed by their ELF name. Note that the keywords are only listed when the bit in `shdr$q_sh_flags` is set. For example `SHDR$M_SHF_EXECINSTR` (Machine Instructions) is an attribute of the `$CODE$` section.
- ④ The Size of Section Data indicates the number of bytes required for the section.
- ⑤ Alignment Constraint specifies the address boundary at which the linker must place a module's contribution to the section. The number shown here, 10 (hexadecimal), is a byte alignment and not an OpenVMS style (power of 2) of specifying the section attributes.

Figure 3.2 illustrates some of the sections created by the VSI C Compiler for the modules in Examples 3.1, 3.2, and 3.3 on x86-64 and I64 systems. The shaded areas represent the settings of the section attributes the linker considers when sorting the sections into image segments in an executable image. See Section 3.3.4 for more information about how the linker creates segments in an image.

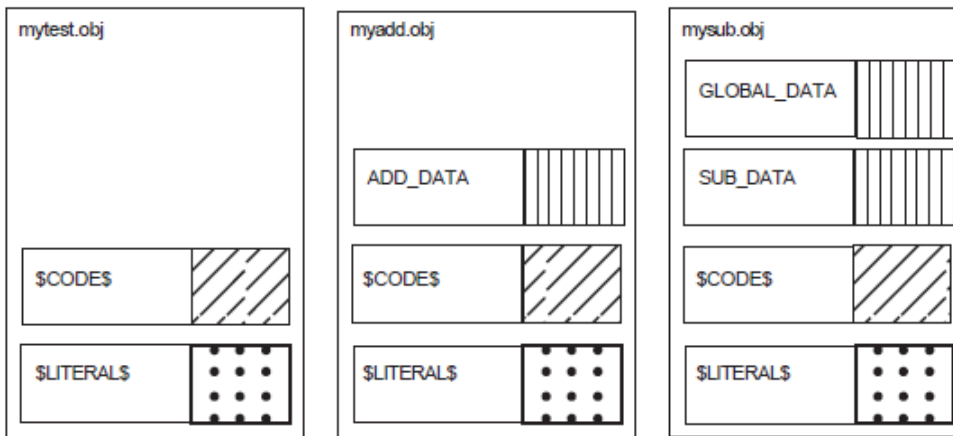
Figure 3.2. Sections Created for Examples 3.1, 3.2, and 3.3

3.2.1. Sections Created by The Linker

Unlike the VAX and Alpha linkers, the x86-64 and I64 linkers create new sections as well as contributions to existing sections for loadable segments.

When the linker assigns a name for a section, the name can be a reserved name containing an embedded space (for example, \$LINKER UNWIND\$). The linker uses the embedded space in a reserved name to prevent you from changing the section attributes. The PSECT_ATTR option reads the embedded space and compresses it out of the name. As such, the name is not read by the linker as you intended and the attributes are preserved.

3.2.1.1. Sections for Relaxed Symbol Definitions

In VSI C, relaxed symbol definitions that can act like a reference or a definition (when no other definition is found) have no section assigned to them. If there is no **hard definition** (that is, a symbol with a compiler-supplied section), the linker allocates a section for the symbol. The section has the same name as the symbol, and is contributed by the linker (labeled with <Linker> in the map).

3.2.1.2. Sections Embedded in Code Segments (I64 Only)

The I64 linker contributes sections to code segments that contain calls to code outside the image, outside the code segment but to another segment within the image, or to code that can't be reached with a normal branch instruction inside the segment (called a trampoline).

The instructions can be helpful when using the debugger to step into subroutines. The instructions are grouped in 128-bit bundles, with a series of dashes marking the end of a bundle.

<Linker> is used to label the linker contribution in the map, usually at the end of the code section (normally named \$CODE\$).

Calls Out of the Image

The compiler is unaware whether a call is internal or external to the image being created. The linker has this knowledge and for external calls, generates the following sequence of instructions:

```

addl r15=<offset>,r1;;
ld8 r16=[r15],8
nop.i
-----
ld8 r1=[r15]
mov b6=r16
br.few b6;; ❶
-----

```

- ❶ This is an Indirect Branch (B4). For more information, see the *Intel IA-64 Architecture Software Developer's Manual*

In the first instruction, R15 contains the address of the Function Descriptor (FD), which the linker obtained by adding an offset to the Global Pointer register (GP, implemented as R1). R16 is loaded with a pointer to the code address. R1 then receives the new Global Pointer. The branch instruction completes the call sequence.

Calls Out of the Segment to Another Segment in the Same Image

The compiler is unaware whether the destination of a call is in another segment of the same image. The linker has this knowledge and for calls that cross segment boundaries, generates the following sequence of instructions:

```

addl r15=<offset>,r1;;
ld8 r16=[r15]
nop.i
-----
nop.m
mov b6=r16
br.few b6;; ❶
-----

```

- ❶ This is an Indirect Branch (B4). For more information, see the *Intel IA-64 Architecture Software Developer's Manual*

In the first instruction, R15 contains the address of the Function Descriptor (FD), which the linker obtained by adding an offset to the Global Pointer (GP, implemented as R1) register. R16 is loaded with a pointer to the code address. Because the instructions branch to another segment in the same image and because there is one GP per image, the linker can skip copying the GP from the FD.

Calls That Cannot be Reached with Normal Branch Instruction (Trampolines)

The linker uses a trampoline when when the branch-to-code instruction in the same segment (calculated in 128 bit or 16 byte bundles) is more than 21-bit signed offset. The trampoline must be located somewhere within the original 21-bit signed branch. The trampoline then does an indirect branch from the trampoline to the target instruction.

```

nop.m 0x0
movl r15=<offset between the next instruction and the target> ❶
-----
nop.m 0x0
mov r16=ip;; ❷
add r16=r15,r16;;
-----
nop.m 0x0
mov b6=r16
br.few b6;; ❸
-----

```

- ❶ See the *Intel IA-64 Architecture Software Developers Manual*.
 ❷ The `ip` is the PC; it points to the previous instruction that indicates the beginning of an instruction bundle.

- ③ This is an Indirect Branch (B4). For more information, see the *Intel IA-64 Architecture Software Developer's Manual*.

3.2.1.3. Short Data Sections (I64 Only)

In order to make position-independent code that does not require any relocations, Itanium platforms allow code to make a reference to pointers and other short data using offsets from an address in a register. This special register is called the Global Pointer (GP) register. The language processors place such data into sections named short data sections. It is the task of the linker to collect these sections into a segment or segments and to determine the GP value. The GP value is determined so that the beginning of the first (or only) short data segment is the negative-most offset from the GP within range. For the Intel Itanium architecture, the negative-most offset is 2 MB. Therefore, the GP value is the virtual address of the beginning of the first (or only) short data segment plus 2 MB. If the address range for your short data segment or segments is less than 2 MB, the GP value may not even point to a virtual address mapped by your image. The compilers usually place data in the short data sections that are relatively short (like quadwords or smaller) and not long (like an array).

There are two kinds of short data sections — read-only and read-write. The I64 linker is a major contributor to the read-only short data section. In this section, the linker puts addresses of data and function descriptors (termed procedure descriptors on Alpha) that can be reached by code with a short offset from the Global Pointer register. This section is named \$LINKER SDATA\$. In the map, <Linker> is used to label the linker contributions to this section.

Function descriptors placed in the read-only short data section have varying lengths depending on their type. The types are official and local. Official function descriptors are always three quadwords long. Local function descriptors can be two quadwords or four quadwords long, depending on whether the qualifier /NONATIVE_ONLY is present. If the image is supposed to interoperate with translated images, the /NONATIVE_ONLY qualifier must be used, and local function descriptors will be four quadwords long.

Official function descriptors represent functions that are defined by an image. One example of functions defined by an image are those functions which can be exported from a shareable image by the symbol vector and called by other images. Official function descriptors always contain the address of the first instruction of the function in the first quadword. The GP value under which the function executes is in the second quadword. The third quadword contains a zero, or if the /NONATIVE_ONLY qualifier is used it contains the function's signature or a pointer to the function's signature. A signature describes the parameters and return status of the function. If the third quadword is zero then the function descriptor has no signature, and a translated image is not allowed to call the function.

An official function descriptor has the following format at run-time:

Figure 3.3. Official Function Descriptor

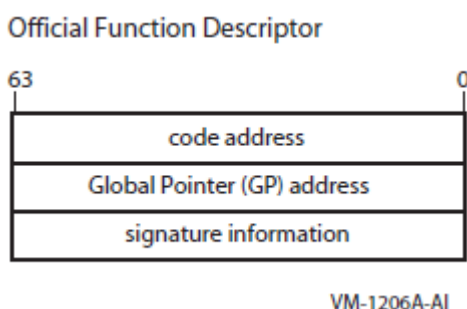

A local function descriptor represents a function outside of the image. Local function descriptors made for images that do not interoperate with translated images contain at run-time the address of the first instruction of the function in the first quadword. The GP value under which the function executes is in the second quadword. The linker generates a fix-up for the function descriptor because it has no knowledge of those addresses. The fix-up is applied by the image activator which has already activated the image with those addresses in it.

A local function descriptor has the following format at run-time:

Figure 3.4. Local Function Descriptor — Two Quadwords

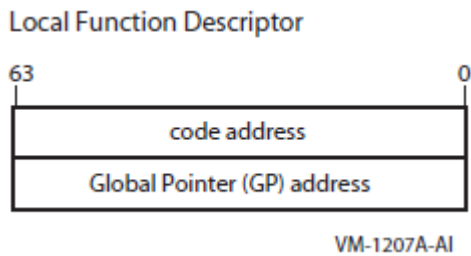

Local function descriptors made by the linker for images that can interoperate with translated images are four quadwords long. At run-time, after the image activator has determined that the target shareable image is translated, the four quadwords in the function descriptor contain the following:

- Entry (code) address of the routine that mediates calls between native and translated code
- Address of this function descriptor
- Signature information for the call
- Pointer to the official function descriptor for the entry point in the translated image (or some other unique identification that can be interpreted by the support facility the mediates calls between native and translated code)

The linker assumes the image activator will find a native image, and issues a fix-up to the image activator to fill in the first two (of four) quadwords with the code address and GP. The third quadword is filled in with signature information, like an official function descriptor. The fourth quadword is filled in with a zero. If the image activator determines that the function referenced by this function descriptor in a native image, it applies the fix-up and ignores the last two quadwords.

3.2.1.4. Section for the Symbol Vector

The x86-64 and I64 linkers place the symbol vector in a section with the name `$LINKER_SYMBOL_VECTOR$`. The I64 linker places this section in the short data segment by default.

In the map, `<Linker Option>` is used to label this linker contribution.

For I64 linking, you can use the qualifier `/SEGMENT=(SYMBOL_VECTOR=NOSHORT)` to move `$LINKER_SYMBOL_VECTOR$` to a data segment which is read-only. The I64 linker creates a read-only data segment if one does not already exist.

For the layout of a symbol vector, see Figure 2.1 (x86-64) and Figure 2.2 (I64).

3.2.1.5. Sections that Contain Unwind Data (I64 Only)

When an exception is signaled by hardware or software, the condition handling facility looks for a condition handler. If a condition handler is found, the handler may choose to call SYSSUNWIND to unwind the stack. SYSSUNWIND has, at its disposal, an unwind table. The unwind table contains a pointer into a variable-sized information block that contains the unwind descriptor list and a language-specific area. The unwind table and the unwind information block are created by the compilers. The linker has to place the contributions to the unwind tables in the same order as the contributions to the code segment for unwinding to work.

The I64 linker renames the compiler-named sections that contain unwind tables (usually named `.IA_64.unwind`) and unwind information blocks (usually named `.IA_64_unwinfo`). It can tell which sections contain unwind tables because those sections have the type `SHT_IA_64_UNWIND`. It also has the link order (`SHF_LINK_ORDER`) attribute set. The link order attribute means that the contributions to the unwind table must be in the same order as contributions pointed to by the `SH_LINK` field (a code section).

The new, reserved name of the section that contains the unwind tables is `$LINKER UNWINDS`. `$LINKER UNWINFO$` is the new, reserved name of the section that contains unwind information. These names appear in the linker map; the actual names of these sections are gone by the time the map is written. The linker uses reserved names for these sections; this means that you are not allowed to change the section attributes with a `PSECT_ATTR=` clause or collect them with the `COLLECT=` option to other clusters. This is because the placement and ordering of these sections are driven by the placement and ordering of the code sections to which they refer. By altering the placement or ordering of the code sections through the use of linker options or input file ordering, the sections containing unwind tables and unwind information blocks will likewise have the placement or ordering of their contributions altered.

`$LINKER UNWINDS` and `$LINKER UNWINFO$` have identical significant attributes and therefore end up in the same unwind segment. This is denoted in the Image Segment Synopsis section of the map by the `[UNWIND]` tag. The unwind segment is connected to the corresponding code segment by entries in the dynamic segment (which the image activator uses for activating an image).

If you have a complex link with an options file that contains a number of `CLUSTER=` or `COLLECT=` options, you may have more unwind segments than you really need. The I64 linker constructs one unwind segment per cluster with one or more code segments. To reduce the number of unwind segments, you should reduce the number of clusters containing code. This is done by collecting code sections onto a smaller number of clusters or onto a single cluster.

3.3. Creating Segments

On x86-64 and I64 systems, the linker creates **segments**, which are analogous to image sections on Alpha and VAX systems. Segments define the memory requirements and page protection characteristics of an image.

To create segments, the linker processes the sections in the object modules specified in the link operation. The number and type of segments the linker creates depend on the input files and what is specified in the link operation. For more information on creating segments, see Section 3.3.1, which describes how the clustering of input files affects segment creation, and Section 3.3.2, which describes the effects of section attributes on segment creation.

3.3.1. Processing Clusters to Create Segments

To create segments, the linker processes the section definitions in the input files you specify in the LINK command. The linker processes these input files on a cluster-by-cluster basis (as described in Section 2.3.1).

Each cluster spawns segments into which sections are placed. However, the linker crosses cluster boundaries when processing sections with the global (GBL) attribute. (In ELF, GBL corresponds to SHF_VMS_GLOBAL). When the linker encounters a section with the global attribute, it searches all the previously processed clusters for a section with the same name and attributes and, if it finds one, places the new definition of the global section in the same cluster as the first definition of the program section.

The linker processes input files in the order by which they appear in the clusters. Note that on x86-64 and I64 systems, there are no **based clusters**, that is, the x86-64 and I64 linkers do not allow you to enter a base address with the CLUSTER= option. In addition, the linkers only have to process clusters once.

For more information about creating clusters, see the descriptions of the CLUSTER= and the COLLECT= option in Chapter 10.

A LINK command to create an image using the object modules in Section 3.2 is shown in Example 3.6.

Example 3.6. Linking Examples 3.1, 3.2, and 3.3

```
$ LINK/MAP/FULL/CROSS MYTEST, MYADD, SYS$INPUT/OPT
CLUSTER=MYSUB_CLUS, ,MYSUB
Ctrl/Z
```

The CLUSTER= option in this link operation causes the linker to create a cluster named MYSUB_CLUS, which contains the object module MYSUB.OBJ. The linker puts the object modules MYTEST.OBJ and MYADD.OBJ in the default cluster. These clusters appear on the linker's cluster list in the following order:

1. MYSUB_CLUS
2. DEFAULT_CLUSTER
3. DECC\$SHR

The linker always processes the default cluster after any user-specified cluster (MYSUB_CLUS). DECC\$SHR was automatically picked up from IMAGELIB.OLB by the x86-64 and I64 linkers after the preceding clusters were processed and there were still unresolved symbols.

3.3.2. Combining Sections into Image Segments

The linker creates segments by grouping together sections with similar attributes. Within a segment, the linker organizes sections alphabetically by name. If more than one object module contributes to the same section, the linker lays out their contributions in the order it processes them.

Figure 3.5 shows how the linker groups the sections in the object modules from the sample link into segments, based on the setting of their significant attributes. In the figure, the settings of these significant attributes are represented by shading. (The figure considers attributes that are significant when creating executable images, and does not consider the SHR attribute as significant as it does with shareable images. Section 3.3.4 provides more information about which program section attributes are significant).

Note that in Figure 3.5, the relaxed definition from MYTEST.OBJ for GLOBAL_DATA appears in the MYSUB_CLUSTER cluster, even though the object module MYTEST.OBJ is in the default cluster. In general, the linker puts all contributions to a global section in the cluster in which it is first defined. In the relaxed case, the linker chooses the memory from the hard definition that occurs in MYSUB.OBJ.

Figure 3.5. Combining Sections into Image Segments — Part 1

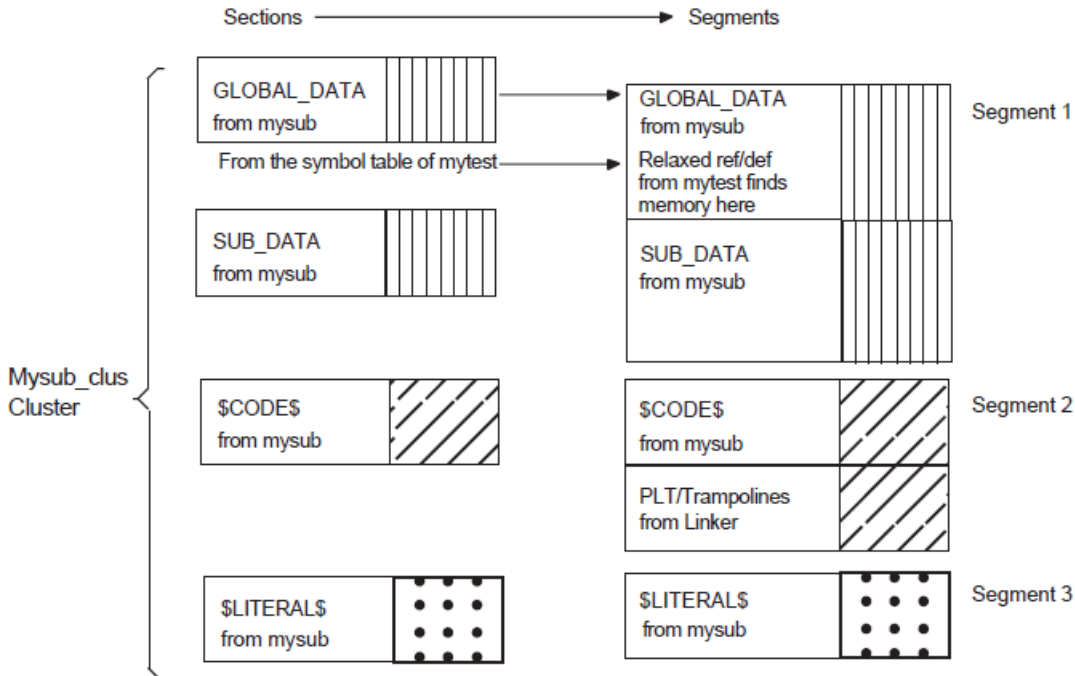

VM-1197A-AI

Figure 3.6 continues the representation in Figure 3.5.

Figure 3.6. Combining Sections into Image Segments — Part 2

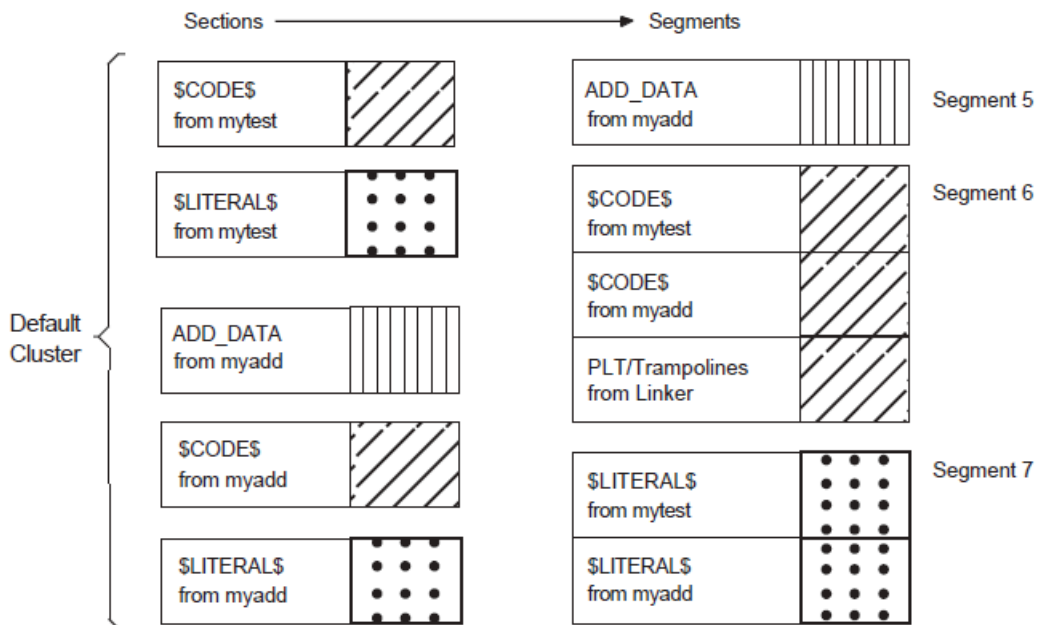

VM-1198A-AI

3.3.3. Traditional OpenVMS Image Attribute Terms and ELF Terms

The ELF format has fewer attributes than a traditional OpenVMS image. Some of the attributes are expressed in the segment header and some are not used on x86-64 and I64 systems. In addition, the linker creates an image file in the ELF format. However, for compatibility, the x86-64 and I64 linkers write a map file with image attribute names the same as for other OpenVMS systems. Other utilities like ANALYZE/IMAGE simply display the ELF terms. Table 3.3 shows how traditional OpenVMS image attribute terms are mapped ELF terms.

Table 3.3. Mapping OpenVMS Image Attribute Terms to ELF Terms

Traditional OpenVMS Image Attribute (prefix [E]ISD\$M_)	Display Name in Linker Map	ELF Image Attribute (prefix PHDR\$M_)
GBL	—	__ ¹
CRF	WRITE,SHARED	PF_VMS_SHARED,PF_W
Demand zero	DEMAND ZERO	Zero segment file size ²
EXE	EXECUTABLE	PF_X
WRT	READ WRITE	PF_W
MATCHCTL	—	__ ¹
LASTCLU	—	__ ³
FIXUPVEC	—	__ ¹
RESIDENT	RESIDENT	PF_VMS_RESIDENT ⁴
VECTOR	VECTOR	PF_VMS_VECTOR
PROTECT	PROTECT	PF_VMS_PROTECT

¹Not an attribute, implemented in the dynamic segment

²Zero PHDR\$Q_P_FILESZ and nonzero PHDR\$Q_P_MEMSZ

³Not used on x86-64 and I64

⁴Reserved to OpenVMS

Note

All sections, and therefore all segments, are position independent. Therefore, there is no PIC segment type on x86-64 and I64.

3.3.4. Processing Significant Section Attributes

When combining sections into segments, the linker considers only significant section attributes, that is, a subset of the section attributes. The set of significant attributes varies according to the type of image being created. When creating an executable image, the linker considers all combinations of the following attributes when combining sections into segments:

- Writability (WRT/NOWRT)
- Executability (EXE/NOEXE)
- Protected vector (VEC/NOVEC)

- Unmodified (NOMOD/MOD)
- Short (SHORT/NOSHORT)
- Allocation in P2 (ALLOC_64BIT/NOALLOC_64BIT)

When creating a shareable image, the linker considers all combinations of the following attributes when combining sections into segments:

- Writability (WRT/NOWRT)
- Executability (EXE/NOEXE)
- Shareability (SHR/NOSHR)
- Protected vector (VEC/NOVEC)
- Unmodified (NOMOD/MOD)
- Short (SHORT/NOSHORT)
- Allocation in P2 (ALLOC_64BIT/NOALLOC_64BIT)

Tables 3.4 and 3.5 list all the possible combinations of the significant section attributes for executable images and shareable images. Note that the order in which the combinations appear in the table (each row) is the same order in which the linker processes them.

For example, the linker first processes all sections with the WRT, NOEXE, NOVEC, MOD, and NOSHORT attributes, creating a segment of sections with these attributes. The linker then processes all sections with the WRT, NOEXE, NOVEC, NOMOD, and NOSHORT attributes, creating another segment for those sections. The linker continues this processing until all the combinations of significant attributes have been processed and all the sections in the cluster have been placed in a segment.

The tables include only sections that are relocatable (with the REL attribute). Absolute sections (with the ABS attribute), by definition, can have no allocation (they contain only constants) and cannot contribute to a segment.

To simplify the tables, they do not include the ALLOC_64BIT attribute. ALLOC_64BIT only determines if the section should be allocated in P2 space. The default is NOALLOC_64BIT. This attribute does not influence the segment attributes of the created segment. But obviously, two sections, whose attribute only differ in ALLOC_64BIT, end up in different segments. On I64, the ALLOC_64BIT attribute can be set for all sections except the ones with the SHORT attribute.

The linker creates additional segments that cannot be controlled by the user (see Section 3.4.3).

The tables assume that the images are linked using the /DEMAND_ZERO qualifier, which is the default. (When this qualifier is specified, the linker groups sections that do not contain any data into demand-zero segments, allocating memory for the segment but not writing zeros to disk). If the image is linked with the /NODEMAND_ZERO qualifier, then the linker allocates space for the segment in the image file. Note that the /NODEMAND_ZERO qualifier does not affect how the linker sorts sections; it proceeds exactly as specified by the table. However, when the image is written, the linker allocates disk space for the segment and fills the space with zeros.

The tables also show how a particular combination of section attributes determines the attributes of the segment in which it is placed. For more information about segment attributes, see Section 3.3.6.

Table 3.4. Mapping Section Attributes to Segment Attributes for Executable Images

Significant Section Attribute Settings					Segment Attributes Set (prefix PHDR\$V_)
NOEXE	WRT	NOVEC	MOD	NOSHORT	PF_R,PF_W
NOEXE	WRT	NOVEC	NOMOD	NOSHORT	PF_R,PF_W,Demand zero ¹
NOEXE	WRT	VEC	MOD	NOSHORT	PF_R,PF_W,PF_VMS_VECTOR, PF_VMS_PROTECT
EXE	NOWRT	NOVEC	MOD	NOSHORT	PF_R,PF_X
EXE	WRT	NOVEC	MOD	NOSHORT	PF_R,PF_W,PF_X
EXE	NOWRT	VEC	MOD	NOSHORT	PF_R,PF_X,PF_VMS_VECTOR, PF_VMS_PROTECT
EXE	WRT	VEC	MOD	NOSHORT	PF_R,PF_W,PF_X,PF_VMS_VECTOR, PF_VMS_PROTECT
EXE	NOWRT	* ²	NOMOD	NOSHORT	PF_R,PF_X
EXE	WRT	*	NOMOD	NOSHORT	PF_R,PF_W,PF_X
NOEXE	NOWRT	NOVEC	MOD	NOSHORT	PF_R
NOEXE	NOWRT	NOVEC	NOMOD	NOSHORT	PF_R,Demand zero ¹
NOEXE	NOWRT	VEC	MOD	NOSHORT	PF_R,PF_VMS_VECTOR, PF_VMS_PROTECT
*	WRT	*	*	SHORT	PF_R,PF_W,PF_VMS_SHORT
*	NOWRT	*	*	SHORT	PF_R,PF_VMS_SHORT

¹Demand zero is no attribute, it is expressed as a file size of zero for a segment with nonzero memory size. If the /NODEMAND_ZERO qualifier is specified, the file size is equal to the memory size of the segment.

²An asterisk (*) means any section attribute.

Table 3.5. Mapping Section Attributes to Segment Attributes for Shareable Images

Significant Section Attribute Settings						Segment Attributes Set (prefix PHDR\$V_)
NOSHR	NOEXE	WRT	NOVEC	MOD	NOSHORT	PF_R,PF_W
NOSHR	NOEXE	WRT	NOVEC	NOMOD	NOSHORT	PF_R,PF_W,Demand zero ¹
SHR	NOEXE	WRT	NOVEC	MOD	NOSHORT	PF_R,PF_W,PF_VMS_SHARED
SHR	NOEXE	WRT	NOVEC	NOMOD	NOSHORT	PF_R,PF_W,PF_VMS_SHARED
NOSHR	NOEXE	WRT	VEC	MOD	NOSHORT	PF_R,PF_W,PF_VMS_VECTOR, PF_VMS_PROTECT
SHR	NOEXE	WRT	VEC	MOD	NOSHORT	PF_R,PF_W,PF_VMS_VECTOR, PF_VMS_PROTECT
NOSHR	EXE	NOWRT	NOVEC	MOD	NOSHORT	PF_R,PF_X
NOSHR	EXE	WRT	NOVEC	MOD	NOSHORT	PF_R,PF_W,PF_X
SHR	EXE	NOWRT	NOVEC	MOD	NOSHORT	PF_R,PF_X,PF_VMS_SHARED
SHR	EXE	WRT	NOVEC	MOD	NOSHORT	PF_R,PF_W,PF_X, PF_VMS_SHARED
NOSHR	EXE	NOWRT	VEC	MOD	NOSHORT	PF_R,PF_X,PF_VMS_VECTOR, PF_VMS_PROTECT

Significant Section Attribute Settings						Segment Attributes Set (prefix PHDR\$V_)
NOSHR	EXE	WRT	VEC	MOD	NOSHORT	PF_R,PF_W,PF_X, PF_VMS_VECTOR, PF_VMS_PROTECT
SHR	EXE	NOWRT	VEC	MOD	NOSHORT	PF_R,PF_X,PF_VMS_VECTOR, PF_VMS_PROTECT,PF_VMS_ SHARED
SHR	EXE	WRT	VEC	MOD	NOSHORT	PF_R,PF_W,PF_X, PF_VMS_VECTOR, PF_VMS_PROTECT, PF_VMS_SHARED
* ²	EXE	NOWRT	*	NOMOD	NOSHORT	PF_R,PF_X
*	EXE	WRT	*	NOMOD	NOSHORT	PF_R,PF_W,PF_X
NOSHR	NOEXE	NOWRT	NOVEC	MOD	NOSHORT	PF_R
NOSHR	NOEXE	NOWRT	NOVEC	NOMOD	NOSHORT	PF_R,Demand zero ¹
SHR	NOEXE	NOWRT	NOVEC	MOD	NOSHORT	PF_R,PF_VMS_SHARED
SHR	NOEXE	NOWRT	NOVEC	NOMOD	NOSHORT	PF_R,PF_VMS_SHARED
NOSHR	NOEXE	NOWRT	VEC	MOD	NOSHORT	PF_R,PF_VMS_VECTOR, PF_VMS_PROTECT
SHR	NOEXE	NOWRT	VEC	MOD	NOSHORT	PF_R,PF_VMS_VECTOR, PF_VMS_PROTECT, PF_VMS_SHARED
*	*	WRT	*	*	SHORT	PF_R,PF_W,PF_VMS_SHORT
*	*	NOWRT	*	*	SHORT	PF_R,PF_VMS_SHORT

¹Demand zero is no attribute, it is expressed as a file size of zero for a segment with nonzero memory size. If the /NODEMAND_ZERO qualifier is specified, the file size is equal to the memory size of the segment.

²An asterisk (*) means any section attribute.

For example, Table 3.6 summarizes the settings of some significant attributes of the user controllable sections in the module MYSUB.OBJ (see Example 3.6).

Table 3.6. Significant Attributes of User Sections from Module MYSUB

User Section	Writability	Executability	Short Data
GLOBAL_DATA	WRT	NOEXE	NOSHORT
SUB_DATA	WRT	NOEXE	NOSHORT
\$CODE\$	NOWRT	EXE	NOSHORT
\$LITERAL\$	NOWRT	NOEXE	NOSHORT

The linker puts these four sections into three segments because only two have compatible attributes.

- The GLOBAL_DATA and SUB_DATA sections have identical attributes, including the WRT attribute.
- The \$CODE\$ and \$LITERAL\$ sections have the NOWRT attribute and differ in the EXE attribute.

The linker collects all these sections in segments in the named cluster `MYSUB_CLUS`, as requested with the `CLUSTER=` option in Example 3.6.

The linker performs similar processing of the sections in the default cluster in Example 3.6. The Image Segment Synopsis section of the map file lists the clusters the linker created and lists the segments it created for each cluster. This map section also describes the layout of the image in memory, including the base address of each segment within the image. Example 3.7 illustrates an excerpt of the Image Segment Synopsis section from the map file produced with the sample link (Example 3.6). Note that for x86-64 and I64, the listing does not include clusters for shareable images, like the VSI C Run-Time Library.

Example 3.7. Segment Information in a Map File

```

+-----+
! Image Segment Synopsis !
+-----+
Seg#  Cluster          Type      Base Addr  Protection  Attributes
-----
  0  MYSUB_CLUS         LOAD      00010000  READ WRITE
  1                               LOAD      00020000  READ ONLY  EXECUTABLE
  2                               LOAD      00030000  READ ONLY
  3                               LOAD      00040000  READ ONLY  [UNWIND]  ❶❷
  4  DEFAULT_CLUSTER   LOAD      00050000  READ WRITE
  5                               LOAD      00060000  READ ONLY  EXECUTABLE
  6                               LOAD      00070000  READ ONLY
  7                               LOAD      00080000  READ ONLY  [UNWIND]  ❶❷
  8                               LOAD      00090000  READ ONLY  SHORT  ❶
  9  DYNAMIC            Q-00000000
                               80000000  READ ONLY  ❶

```

- ❶ Linker created segments which can not be controlled by the user (see Section 3.4.3).
- ❷ UNWIND is not a segment attribute and is therefore printed in brackets. Marking the unwind segment here, helps to differentiate this segment from segments into which other sections are collected.

For more information about the image segment synopsis section of a map file, see Chapter 5.

To find out which sections the linker placed in each segment, look at the Program Section Synopsis section of the map file. This section lists all the sections in each cluster and lists the contributions (the number of bytes) to each section from each object module. By comparing the base address of the sections with the base address of the segments in the Image Segment Synopsis section, you can tell in which segment the sections appear. Example 3.8 is an excerpt from the Program Section Synopsis section of the map file produced by the sample link operation (Example 3.6).

Example 3.8. Section Information in a Map File

```

+-----+
! Program Section Synopsis !
+-----+
Psect Name Module/Image  Base      End      Length  Attributes  ❶
-----
GLOBAL_DATA
  MYSUB          00010000 00010003 00000004 ( 4.) NOEXE, WRT
SUB_DATA
  MYSUB          00010010 00010013 00000004 ( 4.) NOEXE, WRT
$CODE$
  MYSUB          00020000 0002008F 00000090 (144.) EXE, NOWRT
  <Linker>       00020070 0002008F 00000020 ( 32.)
$LITERAL$
  MYSUB          00030000 0003000C 0000000D ( 13.) NOEXE, NOWRT
$LINKER UNWIND$
  MYSUB          00040000 00040017 00000018 ( 24.) NOEXE, NOWRT
$LINKER UNWINFO$
  MYSUB          00040018 0004002F 00000018 ( 24.) NOEXE, NOWRT

```

```

MYSUB          00040018 0004002F 00000018 ( 24.)
ADD_DATA      00050000 00050003 00000004 (  4.) NOEXE, WRT
MYADD         00050000 00050003 00000004 (  4.) Initializing Contribution
$CODE$       00060000 000602CF 000002D0 ( 720.) EXE,NOWRT
MYTEST       00060000 000601BF 000001C0 ( 448.)
MYADD        000601C0 0006022F 00000070 ( 112.)
<Linker>     00060230 000602CF 000000A0 ( 160.)
$LITERAL$    00070000 0007003C 0000003D (  61.) NOEXE,NOWRT
MYTEST       00070000 00070027 00000028 (  40.)
MYADD        00070030 0007003C 0000000D (  13.)
$LINKER UNWIND$ 00080000 00080047 00000048 (  72.) NOEXE,NOWRT
MYTEST       00080000 0008002F 00000030 (  48.)
MYADD        00080030 00080047 00000018 (  24.)
$LINKER UNWINFO$ 00080048 000800A7 00000060 (  96.) NOEXE,NOWRT
MYADD        000601C0 0006022F 00000070 ( 112.)
<Linker>     00060230 000602CF 000000A0 ( 160.)
$LITERAL$    00070000 0007003C 0000003D (  61.) NOEXE,NOWRT
MYTEST       00070000 00070027 00000028 (  40.)
MYADD        00070030 0007003C 0000000D (  13.)
$LINKER UNWIND$ 00080000 00080047 00000048 (  72.) NOEXE,NOWRT
MYTEST       00080000 0008002F 00000030 (  48.)
MYADD        00080030 00080047 00000018 (  24.)
$LINKER UNWINFO$ 00080048 000800A7 00000060 (  96.) NOEXE,NOWRT
MYTEST       00080048 0008008F 00000048 (  72.)
MYADD        00080090 000800A7 00000018 (  24.)
$LINKER SDATA$ 00090000 000900B7 000000B8 ( 184.) NOEXE,NOWRT,SHORT
<Linker>     00090000 000900B7 000000B8 ( 184.)

```

- ❶ To fit on a page, the attribute column of the Program Section Synopsis is reduced to show only the attributes listed in Table 3.6.

For more information about the Program Synopsis Section of a map file, see Section 5.2.4.

3.3.5. Allocating Memory for Segments

When it creates a segment, the linker allocates enough memory for the image segment to accommodate all the sections it contains. Each section definition includes its size.

The linker aligns segments on CPU-specific page boundaries. Within a segment, the linker assigns to each section a virtual address relative to the base address of the segment.

Concatenated Sections

If the sections have the concatenated (CON) attribute set, the linker positions the sections one after the other within a segment, inserting padding bytes between the sections if necessary to achieve the alignment requirement of a particular contribution to a section. The linker retains the alignment specified for each section contribution but uses the largest alignment of a contributing module as the alignment of the whole section.

With a PSECT_ATTR= option you can align the section within the segment. However, aligning the section does not influence the alignment of the individual contributions to the section. The linker follows the compiler's alignment specification when it aligns each individual contribution. If you specify a smaller alignment for a section than any compiler-assigned alignment from all contributions, the linker issues a warning.

Overlaid Program Sections

If the sections have the overlaid (OVR) attribute set, the linker uses the same start address for the sections so that they occupy the same virtual memory (that is, the sections overlay each other). For overlaid sections, the linker allocates enough space to accommodate the largest of all the section contributions. Note that the linker does *not* generate a warning message if the contributions specify different size allocations.

Any module can initialize the contents of an overlaid program section. However, the x86-64 and I64 linkers only allow compatible initializations for the same section data. See Section 3.4.1 for an explanation of a compatible initialization.

Assigning Virtual Addresses

The linker allocates virtual memory to all the segments beginning at a page size boundary.

The x86-64 linker places code segments in the P2 region by default and uses the default page size of 2000 hexadecimal. The `/SEGMENT=CODE=P0` option can be specified to place code segments in the P0 region. Non-code segments (without the `ALLOC_64BIT` attribute specified) are placed in the P0 region by default.

The I64 linker places segments in the P0 region by default and uses the default page size of 10000 hexadecimal. The `/SEGMENT=CODE=P2` option can be specified to place segments in the P2 region.

For x86-64 and I64 linking, you can specify the page size value using the `/BPAGE` qualifier. For information about the `/BPAGE` qualifier, see Chapter 10.

On x86-64 systems, the first P0 segment is placed at 2000 hexadecimal. On I64 systems, the first P0 segment is placed at 10000 hexadecimal, leaving the first page unused as a guard page. The first P2 segment (for example, containing sections with the `ALLOC_64BIT` attribute) is placed at 80000000 hexadecimal. However, all segment base addresses are only suggestions for the OpenVMS image activator. The image activator can determine a different base address for each segment (within the address region) to map the segment. This is always the case for shareable images. This is also the case for all images being installed as resident images, where the `INSTALL` utility determines the addresses. Unlike the Alpha and VAX platforms, executable images can also have their segment base addresses determined by the image activator or the `INSTALL` utility.

An image not activated by the OpenVMS image activator might need a specific base address for the first segment. For such an image, you can specify this address with the `/BASE_ADDRESS` qualifier. (For information about the `/BASE_ADDRESS` qualifier, see Chapter 10).

Because the linker processes clusters in the order in which they appear in the cluster list, the virtual address space of the final image will generally contain contiguous segments of consecutive clusters on the basis of their order in the cluster list.

After allocating memory for all segments in a cluster, the linker relocates their contents by performing the following processing:

1. **Relocating each section in the segment.** The linker adds the starting virtual address of the segment to the relative offset of the section from the base of the segment.
2. **Relocating each global symbol in the section.** The linker adds the newly calculated section virtual address to the relative offset of the global symbols from the base of the section.

3.3.6. Segment Attributes

When creating segments, the linker assigns attributes to the segment based on the attributes of the sections it contains. The segment attributes describe certain characteristics of the portion of memory they represent, for example, the protection characteristics. For example, a segment that contains sections with the writability attribute also has the writability attribute set. Tables 3.4 and 3.5 include the segment attributes associated with a segment that contains sections with a particular set of attributes. Table 3.7 lists all the segment attributes. Segment attributes, like section attributes, are Boolean values that are either on or off.

Table 3.7. Segment Attributes

Attribute	Symbol (prefix PHDR\$V_)	Function
Executability	PF_X	The mapping of the EXE attribute from the section.
Write	PF_W	The mapping of the WRT attribute from the section.
Readability	PF_R	All segments have this attribute set.
Modified if Relocated	PF_VMS_NOWRIT_RELOC	The attribute is set by the linker if the the segment contents is changed when relocated. The image activator sets the protection to NOWRT after the relocation.
Initial Code	PF_VMS_INITALCODE	This attribute is reserved to OpenVMS.
Resident	PF_VMS_RESIDENT	This attribute is reserved to OpenVMS.
Vectored	PF_VMS_VECTOR	The mapping of the VEC attribute from the section.
Protected	PF_VMS_PROTECT	Protect indicates that a section is protected. The linker sets the PF_VMS_PROTECT attribute whenever PF_VMS_VECTOR is set. PROTECT is also set if the /PROTECT qualifier is used, or if the cluster that the segment is spawned from came after a PROTECT=YES option (and before a PROTECT=NO option).
Modified by Fix-Ups	PF_VMS_NOWRIT_FIXUP	The attribute is set by the linker if the segment contents is changed for fix-ups. The image activator sets the protection to NOWRT after the fix-ups are applied.
Short Data ¹	PF_VMS_SHORT	The mapping of the SHORT attribute from the section.
Shared	PF_VMS_SHARED	The SHR mapping of the SHR attribute from the sections.

¹I64 specific

The Image Segment Synopsis section of a map file lists the attributes of each segment created in the Protection and Attributes columns. See Example 3.7 for an illustration and see Table 3.3 for the display names in these columns. You can also get a listing of all the segments created by the linker by using the ANALYZE/IMAGE utility. The output generated by this utility includes a list of all the segments that make up the image, with their attributes. An excerpt from the analysis of the image file MYTEST.EXE is shown in Example 3.9.

Example 3.9. Image Segment Descriptions in an ANALYZE/IMAGE Display

```

SEGMENT HEADER ENTRY 0.
Offset   Description                               Hex (<bitmask>)  Interpretation
-----   -
00000000 Segment Type:                                00000001  PHDR$K_PT_LOAD
00000004 Segment Flags:                                00000006  ❶
          Segment is writeable:                <00000002>  PHDR$M_PF_W
          Segment is readable:                  <00000004>  PHDR$M_PF_R
00000008 Offset to Segment Data:              0000000000000400  ❷

```

```

00000010 Memory Virtual Address:      0000000000010000 ③
00000018 Page Fault Cluster Size:   0000000000000000 ④
00000020 Segment Size in File:       0000000000000014 ⑤
00000028 Segment Size in Memory:    0000000000000014 ⑥
00000030 Alignment Constraint:      0000000000000010
SEGMENT HEADER ENTRY 1. (0001)      56. (0038) bytes
Offset  Description                  Hex (<bitmask>)  Interpretation
-----  -----
00000000 Segment Type:                        00000001  PHDR$K_PT_LOAD
00000004 Segment Flags:                  00000005  ①
      Segment is executable:          <00000001> PHDR$M_PF_X
      Segment is readable:            <00000004> PHDR$M_PF_R
00000008 Offset to Segment Data:     0000000000000600 ②
00000010 Memory Virtual Address:     0000000000020000 ③
00000018 Page Fault Cluster Size:   0000000000000000 ④
00000020 Segment Size in File:       0000000000000090 ⑤
00000028 Segment Size in Memory:    0000000000000090 ⑥
00000030 Alignment Constraint:      0000000000000010
.
.
.

```

The items in the following list correspond to the numbers in Example 3.9:

- ① The settings of segment attributes. Table 3.7 lists these attributes.
- ② The offset in the image file in bytes, at which the segment begins.
- ③ The virtual base address assigned to the segment by the linker. Note that at run-time the image activator may decide to map this segment at a different address.
- ④ The number of page lets that should be mapped in when the initial page fault occurs. You can set this value by using the CLUSTER= option.
- ⑤ The size of the segment in the image file, expressed in bytes. Note that demand zero segments have a file size of zero but a nonzero memory size.
- ⑥ The size of the segment in the memory, expressed in bytes. For the shown segments, both sizes are identical so they are not demand zero segments.

3.3.7. Controlling Segment Creation

You can control how the linker combines sections into segments in the following ways:

- By modifying the attributes of sections
- By using the SOLITARY attribute
- By using the /SEGMENT_ATTRIBUTES qualifier
- By putting object modules into named clusters
- By collecting sections

3.3.7.1. Modifying Section Attributes

The linker combines sections in the same cluster into the same segment if they have the same settings for the significant section attributes. To force the linker to put the sections into different segments, change the attributes of one of the sections by using the PSECT_ATTR= option.

For example, in the sample link operation, the GLOBAL_DATA section has the WRT attribute. But its contents, the variable global_data, serves as a constant (initialized but never changed). If you want the GLOBAL_DATA section to appear in a read-only segment, change the writability attribute. For example, in the following link of the sample programs, the writability attribute is set to NOWRT.

```
$ LINK/MAP/FULL MYTEST,MYADD,SY$INPUT/OPT
CLUSTER=MYSUB_CLUS,,MYSUB
PSECT_ATTR=GLOBAL_DATA,NOWRT
Ctrl/Z
```

Example 3.10 shows the image and program section synopsis for the second link.

Example 3.10. Image and Program Section Synopsis of Second Link

```

+-----+
! Program Section Synopsis !
+-----+
Psect Name Module/Image   Base      End      Length  Attributes
-----
SUB_DATA                00010000 00010003 00000004 (  4.) NOEXE, WRT,NOVEC, MOD
MYSUB                   00010000 00010003 00000004 (  4.) Initializing Contribution
$CODE$                  00020000 0002008F 00000090 ( 144.) EXE,NOWRT,NOVEC, MOD
MYSUB                   00020000 0002006F 00000070 ( 112.)
<Linker>                00020070 0002008F 00000020 (  32.)
$LITERAL$               00030000 0003000C 0000000D (  13.) NOEXE,NOWRT,NOVEC, MOD
MYSUB                   00030000 0003000C 0000000D (  13.)
GLOBAL_DATA             00030010 00030013 00000004 (  4.) NOEXE,NOWRT,NOVEC, MOD
MYSUB                   00030010 00030013 00000004 (  4.) Initializing Contribution
$LINKER UNWIND$        00040000 00040017 00000018 (  24.) NOEXE,NOWRT,NOVEC, MOD
MYSUB                   00040000 00040017 00000018 (  24.)
.
.
.
```

Note that there is no change in the number and attributes of the segments. However, the GLOBAL_DATA section moved into an existing read-only segment. (It also moved in the address space.) The GLOBAL_DATA section is now in the same segment as the read-only \$LITERAL\$ section, which it follows, based on alphabetical order (for a comparison, see Example 3.8).

3.3.7.2. Alternate Way to Modify Section Attributes

With the /SEGMENT_ATTRIBUTE qualifier, you can change some attributes for a class of sections. The keywords SHORT_DATA, CODE, and SYMBOL_VECTOR define obvious classes of sections: all sections with the SHORT, all sections with the EXE attribute, and the symbol vector section. The attribute to change depends on the class.

For short data sections, you can set WRT. For executable sections, you can set or clear the ALLOC_64BIT attribute. For the I64 symbol vector, you can set or clear the SHORT attribute. For the x86-64 symbol vector, setting or clearing the SHORT attribute is ignored. To be compatible with other DCL command qualifiers, for the first two classes, more descriptive names are used: WRITE for WRT, P0 for NOALLOC_64BIT, P2 for ALLOC_64BIT. For information about the /SEGMENT_ATTRIBUTE qualifier, see Chapter 10.

With /SEGMENT_ATTRIBUTE, the section attributes are changed before the sections are collected into segments. As a result, the effect is the same as using the PSECT_ATTR= for each member of the class. However, /SEGMENT_ATTRIBUTE can do more because even the linker-generated sections are members of the classes (for example, \$LINKER SDATA\$ and \$LINKER SYMBOL_VECTOR\$).

To move all code into P2 space, you can use the /SEGMENT_ATTRIBUTE=CODE=P2 command qualifier. Please note, that if you use clusters in the same link command (with linker options) and if EXE sections are put on specific clusters, setting ALLOC_64BIT does not change the per cluster segment creation. You then will see more than one executable segment with base addresses in P2 space.

For I64 linking, the /SEGMENT_ATTRIBUTE=SHORT_DATA=WRITE command qualifier allows you to combine the read-only and the read-write short data segments into a single segment,

reclaiming up to 65,535 bytes of unused, read-only space (default value for /BPAGE). When setting `SHORT_DATA` to `WRITE`, your program may accidentally write to formerly read-only data. Therefore, this qualifier is recommended only if your short data segment has reached the limit of 4 MB.

On I64, the linker stores the shareable image's symbol vector into the read-only short data segment by default. That is, the linker created section `$LINKERSYMBOL_VECTOR$` has the `SHORT` attribute. By specifying `/SEGMENT_ATTRIBUTE=SYMBOL_VECTOR=NOSHORT`, the linker clears the `SHORT` attribute of the section and, therefore, collects the symbol vector into a read-only data segment of the default cluster. If the shareable image has no read-only data se is created. This frees up the symbol vector entries from the short data. This qualifier is recommended only if your short data segment has reached the limit of 4 MB.

3.3.7.3. Manipulating Cluster Creation

In general, the linker creates segments on a per-cluster basis; that is, only sections within a particular cluster can contribute to segment creation. (The linker can collect sections with the global attribute from all clusters into a single segment. However, there is one exception: sections with the I64 `SHORT` attribute can not be collected.) To ensure that a section appears in a particular segment, put the section in a specific cluster.

For example, in the sample link operation illustrated in Example 3.6, the linker puts all the sections in the object module `MYSUB.OBJ` in the cluster named `MYSUB_CLUS` because the `CLUSTER=` option is specified. If you wanted to group all of the sections that contain code from all the other clusters into the `MYSUB_CLUS` cluster, you could specify the `COLLECT=` option, as in the following example.

Note

Section naming conventions are language processor specific. By convention, most OpenVMS language processors put the code they generate into sections named `$CODE$`. An exception is the VSI C++ compiler which puts code into a section named `.text`.

```
$ LINK/MAP/FULL MYTEST, MYADD, SYS$INPUT/OPT
CLUSTER=MYSUB_CLUS, , ,MYSUB
COLLECT=MYSUB_CLUS, $CODE$
Ctrl/Z
```

3.3.7.4. Isolating a Section into a Segment

You can specify that the linker places a particular section into its own segment. This can be useful for programs that map data into predefined locations within an image.

To isolate a section into a segment, specify the `SOLITARY` attribute of the section using the `PSECT_ATTR=` option. For example, to isolate the `GLOBAL_DATA` section in the sample link into its own segment, specify the following:

```
$ LINK/MAP/FULL MYTEST, MYADD, SYS$INPUT/OPT
CLUSTER=MYSUB_CLUS, , ,MYSUB
PSECT_ATTR=GLOBAL_DATA, SOLITARY
Ctrl/Z
```

When mapping data into an existing location in the virtual memory of your program using the Create and Map Global Section (`$CRMPSC`) system service or the Map Global Section (`$MGBLSC`) system service, you must specify an address range (in the `inadr` argument) that is aligned on a CPU-specific page boundary. Because the linker aligns segments on CPU-specific page boundaries and the section in which the global section is to be mapped is the only section in the segment, you ensure that the start

address of the location is page aligned. In addition, because x86-64 and I64 systems must map at least an entire page of memory at a time, using the SOLITARY attribute allows you to ensure that no other data is in the segment. By default, the linker creates the next segment on the next page boundary so that no data can be overwritten.

Note that SHORT sections can not be isolated. That is, an attempt to set the SOLITARY attribute to a SHORT section is ignored by the I64 linker and a warning is issued.

3.4. Initializing an Image on x86-64 and I64 Systems

After allocating memory for the image, the linker initializes the image by writing the binary contents into the segment buffers, that is, by copying section data from the object modules. In addition, the linker inserts the addresses of symbols within the image wherever they are referenced.

3.4.1. Handling of Initialized Overlaid Sections

On x86-64 and I64 systems, the ELF object language does not implement the feature of the Alpha and VAX object language which allows the initialization of portions of the sections. When an initialization is made, the entire section is initialized. Subsequent initializations of this section can be performed only if they are compatible. A subsequent initialization is compatible if the number of initializers are less or equal to the existing ones and all the values match or if there are more initializers than the existing ones but all the existing values match.

The linker receives entire sections from the compilers that are already initialized. The linker reads all the applicable module initializations to the section and checks for compatible initializations. If they are not compatible, the linker issues the following error message:

```
%ILINK-E-INVORINI, incompatible multiple initializations for
overlaid section
  section: <section name>
  module:  <module name for first overlaid section>
  file:    <file name for first overlaid section>
  module:  <module name for second overlaid section>
  file:    <file name for second overlaid section>
```

In this message, the linker lists the first module, which contributes an initialization, and the first module with an incompatible initialization. Note that this is not a full list of all incompatible initializations; it is simply the first one that the linker encounters.

In the Program Section Synopsis of the linker map, each module with an initialization is flagged as Initializing Contribution. Use this information to identify and resolve all the incompatible initializations.

Example 3.11 shows the additional information in the map file shown in Example 3.12.

Example 3.11. Compatible Initializations

```
$ cre one.c
#pragma extern_model common_block
int common_data[]={0,1,2,3};
int main (void) {return 1;}
Ctrl/Z
$ cc one
$ cre two.c
#pragma extern_model common_block
int common_data[]={0,1};
Ctrl/Z
```

```

$ cc two
$ cre three.c
#pragma extern_model common_block
int common_data[]={0,1,2,3,4,5,6,7};
Ctrl/Z
$ cc three
$ link/map one,two,three
$

```

Example 3.12 shows the program section synopsis of the linker map for Example 3.11. Note that the Align and Attributes fields normally continue after the Length field but were modified to fit on the page.

Example 3.12. Linker Map Showing Program Section Synopsis

```

+-----+
! Program Section Synopsis !
+-----+

Psect Name Module/Image      Base      End      Length      Attributes
-----
COMMON_DATA                   00010000 0001001F 00000020 ( 32.) OVR,NOEXE, WRT,NOVEC, MOD
      ONE                     00010000 0001000F 00000010 ( 16.) Initializing Contribution
      TWO                     00010000 00010007 00000008 (  8.) Initializing Contribution
      THREE                   00010000 0001001F 00000020 ( 32.) Initializing Contribution

```

Example 3.13 shows an incompatible initialization and the resulting linker message.

Example 3.13. Incompatible Initialization

```

$ cre four.c
#pragma extern_model common_block
int common_data[]={0,1,0,0};
Ctrl/Z
$ cc /extern=common four
$ link one,two,three,four
%ILINK-E-INVORINI, incompatible multiple initializations for
overlaid section
      section: COMMON_DATA
      module: ONE
      file: DISK$USER:[JOE]ONE.OBJ;1
      module: FOUR
      file: DISK$USER:[JOE]FOUR.OBJ;1

```

Note that the sources use a `#pragma` to force the extern common model. For OpenVMS, the default extern model is the relaxed reference/definition (ref/def) model. In that model, only one explicit initialization is allowed. That is, even identical initializations result in a linker MULDEF message.

3.4.2. Writing the Binary Contents of Segments

An object module contains sections with compiler-initialized data. The linker copies the data into the corresponding segment buffer. For overlaid sections, subsequent data overwrites already existing data. With the compatibility check for overlaid sections, (as explained in Section 3.4.1) the linker ensures, that existing data is only overwritten with identical values.

If the compilers initialized data with binary zeros, the buffer contains zeros as well. To save some disk space, the linker can check a segment buffer contents for trailing zeros. This time-consuming operation is not performed by default. You can request it with the `PER_PAGE` keyword for the `/DEMAND_ZERO` qualifier. Similar to a demand-zero section, the trailing zeros are not written to the image file. The amount of trailing demand-zero bytes for such a segment is expressed as the difference between the memory size (including these zeros) and the file size (excluding them). For information about the `PER_PAGE` keyword and the `/DEMAND_ZERO` qualifier, see Chapter 10.

An object module can contain information to express link time calculations for addresses, offsets or values. For example, an offset between two global variables defined in two different object modules can be calculated by the linker and can be used to initialize another global variable. The link time expressions in the object modules are implemented in object relocations. The linker processes them similar to the other object relocations. The calculation is done in a linker internal accumulator and the results written into the corresponding buffer of the segment.

When this processing is complete, the linker has written the binary contents of all code and data sections into segment buffers in its own address space.

3.4.3. Other Image Segments

This section describes other segments created by the x86-64 and I64 linkers:

- Global Offset Table segments (x86-64 only) Section 3.4.3.1
- Unwind segments (I64 only) Section 3.4.3.2
- Short data segments (I64 only) Section 3.4.3.3
- Signature segments (I64 only) Section 3.4.3.4
- Dynamic segments Section 3.4.3.5

3.4.3.1. Global Offset Table Segments (x86-64 Only)

The x86-64 linker creates Global Offset Table (GOT) segments when required by code. They contain addresses of procedures and data. The code uses these addresses to access data and call procedures.

Each code segment in an x86-64 image usually has an associated GOT segment adjacent to it in memory. There are no linker options or qualifiers to control placement of a GOT.

3.4.3.2. Unwind Segments (I64 Only)

Creation of the unwind segments can not be controlled with linker options or qualifiers. You can indirectly influence where they appear by moving code sections. For each cluster with a code segment there is an unwind segment. That is, to move all unwind information into one segment you can collect all code sections on one cluster. Both, the sections and the segments, are listed in the corresponding sections of the linker map.

3.4.3.3. Short Data Segment (I64 Only)

The I64 linker usually creates two short data segments. One of them is read-only and the other is read-write. They must be placed by the image activator at addresses that are the same relative distance apart as the linker originally put them in the image. In other words, they must be relocated together as if they were one segment. Note that the qualifier `/SEGMENT_ATTRIBUTE=SHORT=WRITE` can be used to combine the two short data segments into one read-write segment.

3.4.3.4. Signature Segment (I64 Only)

In case the generated image needs to interoperate with translated images, the I64 linker may create another segment to save procedure signature information. Such a segment is only necessary if the signature can not be stored with the function descriptor (because the signature is greater than 8 bytes,

a quadword). Signatures describe the calling interface for translated images and are described in Section 3.2.1.3.

3.4.3.5. Dynamic Segment

The x86-64 and I64 linkers create a segment with image activator information, referred to as the dynamic segment. This segment contains the necessary information about the shareable images on which the image depends, including the required match control and pointers to the fix-ups. It contains linker flags, for example, if the image was linked with /DEBUG and (by default) should run under the control of the OpenVMS debugger. For shareable images, the dynamic segment contains a pointer to the symbol vector. For all images, it includes fix-up and image relocation information.

The linker flags are initially set by the linker. For x86-64 and I64 images, you can display the settings using the SHOW IMAGE command. The SET IMAGE command enables you to manipulate individual flags or to restore the initial linker setting. If you change the flags, you change the behavior of the image at activation or run-time.

Note

Changing linker flags might result in unexpected image behavior.

Table 3.8 shows the flags set by the linker.

Table 3.8. Linker Flags

Flag ¹	Description	Set by Linker Qualifier or Option
CALL_DEBUG	SY\$IMGSTA checks this flag to determine whether it calls the debugger.	See Table 3.9
DBG_IN_DSF	Debug information is present in the DSF file.	See Table 3.9
DBG_IN_IMG	Debug information is present in the image file.	See Table 3.9
EXE_INIT	Image has a pointer to EXE\$INITIALIZE.	Reserved to OpenVMS
IMGSTA	Image execution is to begin by calling SY\$IMGSTA. The image activator includes SY\$IMGSTA as the first address in the (traditional VMS style) transfer vector.	See Table 3.9
INITIALIZE	Image has a pointer to LIB\$INITIALIZE.	If at least one of the input object modules has a reference to LIB\$INITIALIZE.
MAIN	Image has a main transfer address.	In at least one of the input object modules a procedure was flagged as a main entry point by the corresponding language processor.
MKTHREADS	Enable multiple kernel thread use.	/THREADS_ENABLE=MULTIPLE_KERNEL_THREADS
NOP0BUFS	No P0 buffers for RMS image I/O.	IOSEGMENT=,NOP0BUFS

Flag ¹	Description	Set by Linker Qualifier or Option
P0IMAGE	Image is loaded only to P0 space.	/P0IMAGE
SIGNATURES	TIE Signatures are present.	/NONATIVE_ONLY
TBK_IN_DSF	Traceback records are present in the DSF file.	See Table 3.9
TBK_IN_IMG	Traceback records are present in the image file.	See Table 3.9
UPCALLS	User thread up calls are enabled.	/THREADS_ENABLE=UPCALLS

¹These dynamic segment flags are prefixed with DYNSEG\$SC_VMS_LF_ as a main entry point by the corresponding language processor.

Table 3.9 shows flags determined by a combination of linker qualifiers.

Table 3.9. Flag Settings Determined by /TRACEBACK, /DEBUG, and /DSF

Qualifier	IMGSTA ¹	CALL_DEBUG ¹	TBK_IN_IMG ¹	DBG_IN_IMG ¹	TBK_IN_DSF ¹	DBG_IN_DSF ¹
/NoTrace /NoDebug /NoDSF	0	0	0	0	0	0
/Trace /NoDebug /NoDSF	1	0	1	0	0	0
/NoTrace /Debug /NoDSF	1	1	1	1	0	0
/Trace /Debug /NoDSF	1	1	1	1	0	0
/NoTrace /NoDebug /DSF	0	0	0	0	1	1
/Trace /NoDebug /DSF	1	0	1	0	1	1
/NoTrace /Debug /DSF	1	1	1	0	1	1
/Trace /Debug /DSF	1	1	1	0	1	1

¹These dynamic segment flags are prefixed with DYNSEG\$SC_VMS_LF_.

Notes

- On x86-64 and I64 systems, the value of SY\$IMGSTA is not included in the image's transfer array; only a flag that indicates it is to be called. The image activator already knows the value of SY\$IMGSTA.
- Linker flags do not appear in a DSF file. DSF files are not activated by the image activator (they have no dynamic segment and, therefore, no linker flags field).
- When /DSF is specified along with /TRACEBACK or /DEBUG, the VMS_LF_TBK_IN_IMG (traceback in image) flag is set. This is a difference in behavior from Alpha, where traceback records are not included in the image when /TRACEBACK/DSF or /DEBUG/DSF is specified. Note that debugger records do not get copied to an image whenever /DEBUG/DSF is specified. Here, /DEBUG causes only the VMS_LF_IMGSTA bit to be set in the image.

The dynamic segment contains additional data taken from the linker qualifier keywords or values, or option arguments. Other than these, you can not influence the creation or contents of the dynamic segment.

Note that the linker, by default, assigns a P2 base address for the dynamic segment. The image activator needs the dynamic segment at image activation time, the segment is not used at run-time. The image activator maps the dynamic segment at the proposed P2 address and processes its contents.

The image activator maps the dynamic segments of the shareable images as well, also into P2 space. When all of the information of all these dynamic segments is processed, the image activator may unmap all of these segments.

Fixing Up Addresses, Relocating Images

While the linker assigns addresses to the segments of executable and shareable images in memory, their actual final address is determined by the image activator. Because the linker does not know the actual address that an image will be loaded, it cannot initialize external symbol references nor even symbol references internal to the image itself. In both cases, the image requires a virtual address to make the reference.

In the first case, the image needs to refer to external symbols which are usually resolved from shareable images that will be loaded in the future when the image is activated. For such symbols, the linker creates **fix-ups** that the image activator uses to resolve these external symbolic references.

In the second case, internal symbolic references, the linker creates **image relocations** that the image activator must use to relocate the image. These relocations are used if the image activator uses a load address different from the one proposed for it, which is the case for all shareable images.

The linker combines the fix-ups and image relocations with the activation information in the dynamic segment.

The linker generates fix-ups for symbol references to a shareable image. These references are to global data (by value or by reference) or to global procedures, which the shareable image offers. Depending on the type, the linker generates fix-ups for currently undetermined values or address data in an image segment. The image activator processes these fix-ups. At activation-time, the values and addresses of global data and procedures from the shareable image are known. Then, the image activator fills in the data in the segment to contain the values from the shareable image.

This collaboration of the linker and the image activator makes images independent of the implementation of a public interface, which is manifested in the shareable image and its symbol vector.

The linker generates image relocations for address data of resolved symbol references within the generated image. The address value has to change if the linker-proposed load address changes at image activation time. If the image activator determines a different load address, it uses the linker provided relocations to adjust the address data.

This combined effort of the linker and the image activator preserves the position independence of the images.

3.4.4. Keeping the Size of Image Files Manageable

On OpenVMS, uninitialized static data is initialized with bytes of zeros. Language processors usually do not provide explicit bytes of zeros for uninitialized static data within the object file. Instead, they create conceptual sections filled with bytes of zeros. In ELF, these are sections with a section type specified as SHT_NOBITS (equivalent to the traditional NOMOD section attribute). These sections occupy virtual memory when the image is activated but do not occupy any space in the object file. As these sections are collected together, they will generate demand-zero segments in the image file that will occupy virtual memory at image activation time but do not occupy space in the image file (just as the NOBITS sections do in object files).

When a reference is made to data in a demand-zero segment at run-time, the operating system will map an in-memory page of zeros rather than having to access the image file on disk to load a page of

zeros (a much slower process). Along with that benefit, demand-zero segments keep the image file size smaller.

If one or more contributions to a section do not have the NOMOD attribute set, the section is considered a non-demand-zero section and will be collected into anon-demand-zero segment.

On OpenVMS x86-64 and I64 systems, the linker can create demand-zero segments for both executable and shareable images. However, sections with the SHR and the NOMOD attributes set are not sorted into demand-zero segments in shareable images.

At run-time, uninitialized static data is identical to zero-initialized data. However, x86-64 and I64 language processors supply actual sections with bytes of zeros for static data explicitly initialized to zero in your source code. Such sections are not collected into demand-zero segments. However, the linker can search these non-demand-zero segment buffers for whole pages of trailing zero data and create demand-zero pages from them. Because this process, called **trailing demand-zero compression**, can be time-consuming, it is not done by default. To have this processing done, you must specify the PER_PAGE keyword in the /DEMAND_ZERO qualifier.

Trailing demand-zero compression reduces the size of the image file and usually enhances the performance of the program. As with demand-zero segments, a run-time reference made to data in a demand-zero page will cause the operating system to map an in-memory page of zeros rather than having to go out to disk for a block of zeros.

3.4.4.1. Controlling Demand-Zero Image Segment Creation

On x86-64 and I64 systems, you can force the linker to allocate disk blocks for demand-zero segments by specifying the /NODEMAND_ZERO qualifier. The linker initializes the segment data with zeros and writes the segment data into the image file. Note that the linker still sorts the sections with the NOMOD attribute into separate segments.

To control which sections are placed in demand-zero segments, you must reset the NOMOD attribute of the section by using the PSECT_ATTR=option. The NOMOD attribute cannot be set by the programmer in source code or with linker options, but it can be cleared with PSECT_ATTR=*psect-name*, MOD.

If you set the EXE or VEC attributes for a section for which the compiler has set the NOMOD attribute, the linker issues a warning and sets the section attributes back to NOEXE and NOVEC. The linker creates a read-only demand-zero segment for a segment with the NOWRT attribute. See Chapter 10 for more information.

To request trailing zero compression, you have to use the PER_PAGE keyword for the /DEMAND_ZERO qualifier.

The DZRO_MIN= and the ISD_MAX= options are not supported on x86-64 and I64 systems. The linker ignores these options and produces informational messages. For further explanation of these options, see Chapter 10.

3.4.5. Creating ELF Sections in the Image File

Debugger and traceback sections are processed only if you requested in the LINK command that the debug information be included using the /DEBUG qualifier and that the traceback information not be excluded using the /NOTRACE qualifier. Otherwise, this information is ignored. These sections contain their information in the Debugging With Attribute Record Format, or **DWARF**. DWARF information is kept in several sections, identified by a few section types and distinguished by name.

You are not able to control these sections with the `PSECT_ATTR=` or the `COLLECT=` option clauses. Also, the linker does not collect these sections into segments.

The DWARF sections are combined according to their section type and are usually written into the image file. You can request that the debug information go into a separate file called a debug symbol file (DSF) by using the `/DSF` qualifier. For information about the `/DSF` qualifier, see Chapter 10.

The linker saves some image information in the `.note` ELF section, referred to as the note section. It saves the link time and the linker ID, as well as the image name and the global symbol table name (GSTNAM). This section contains a copy of some of the original link-time value settings for additional fields that can be modified by the `SET IMAGE` command. Further, it contains a modification time stamp field, updated when the `SET IMAGE` command changes field values. Finally, it contains a modification timestamp the `PATCH` utility uses when it changes any data in the image file.

The linker writes global symbols into the image file under the following conditions:

- When you request a shareable image. (If you want to ship a shareable image that cannot be linked against, use `/NOGST` to exclude the global symbol from the shareable image file).
- When you request a debug version of the image.

Table 3.10 indicates where global symbol definitions are written during a link operation that uses the debugging qualifiers:

Table 3.10. Location of Global Symbols Determined by `/TRACEBACK`, `/DEBUG`, and `/DSF`

Qualifier	Global Symbols in Image	Global Symbols in DSF File
<code>/NoTrace /NoDebug /NoDSF</code>	0	0
<code>/Trace /NoDebug /NoDSF</code>	0	0
<code>/NoTrace /Debug /NoDSF</code>	1	0
<code>/Trace /Debug /NoDSF</code>	1	0
<code>/NoTrace /NoDebug /DSF</code>	0	1
<code>/Trace /NoDebug /DSF</code>	0	1
<code>/NoTrace /Debug /DSF</code>	0	1
<code>/Trace /Debug /DSF</code>	0	1

The linker creates the required ELF sections, to implement the symbol table. It creates a section named `.symtab` to contain the values and symbol attributes together with a pointer to a string section, `.strtab`, which contains the symbol names.

3.4.6. Writing the Main Output Files

To complete the image creation the generated data has to be written to the image file. The linker prepares all the necessary ELF header tables, which are updated, when writing segments and ELF sections. The linker writes the headers, and sections, that is the contents of the linker buffers in the following order:

1. Temporary ELF header, temporary segment header table
2. All segments to the image file.

3. The traceback sections to the image or debug symbol file, unless /NOTRACEB specified in the LINK command.
4. The debug sections to the image or debug symbol file, in case /DEBUG was specified in the LINK command.
5. The remaining sections of the map to the map file, if requested in the LINK command. (These sections include all requested sections except the Object Module Synopsis, which it already wrote, and the Link Run Statistics, which it cannot write until the linking operation finishes).
6. The global symbol table to the image file, and also to another separate file, if requested in the LINK command.
7. The supporting ELF sections to the image file.
8. The ELF section header table to the image file.
9. The updated ELF header and segment header table.
10. The link statistics to the map file, if requested in the LINK command.

Chapter 4. Creating Shareable Images (x86-64 and I64)

This chapter describes how to create shareable images on OpenVMS x86-64 and OpenVMS I64 systems and how to declare universal symbols in shareable images.

4.1. Overview of Creating Shareable Images on x86-64 and I64 Systems

To create a shareable image, specify the `/SHAREABLE` qualifier on the `LINK` command line. You can specify as input files in the link operation any of the types of input files accepted by the linker, as described in Chapter 1.

Note, however, to enable other modules to reference symbols in the shareable image, you must declare them as universal symbols. You must declare universal symbols at link time using linker options. The linker lists all universal symbols in the global symbol table (GST) of the shareable image. For x86-64 and I64 images the GST is implemented as a set of symbols in the ELF symbol table (SYMTAB) in the shareable image. The linker processes the GST of a shareable image specified as an input file in a link operation during symbol resolution. For more information about symbol resolution, see Chapter 2.

For x86-64 and I64 linking, you declare universal symbols by listing the symbols in a `SYMBOL_VECTOR=` option statement in a linker options file. You do not need to create a transfer vector to create an upwardly compatible shareable image, as you do with OpenVMS VAX shareable images. The symbol vector can provide upward compatibility. For more information about this topic, see Section 4.2.

The linker supports qualifiers and options that control various aspects of shareable image creation. Table 4.1 lists these qualifiers and options. For more information about linker qualifiers and options, see Chapter 10.

Table 4.1. Linker Qualifiers and Options Used to Create Shareable Images on x86-64 and I64 Systems

Qualifier	Description
<code>/GST</code>	Directs the linker to include universal symbols in the global symbol table (GST) of the shareable image, which is the default. When you specify the <code>/NOGST</code> qualifier, the linker creates an empty GST for the image. See Section 4.2.4 for more information about using this qualifier to create run-time kits.
<code>/PROTECT</code>	Directs the linker to protect the shareable image from write access by user or supervisor mode.
<code>/SHAREABLE</code>	Directs the linker to create a shareable image, when specified in the link command line. When appended to a file specification in a linker options file, this qualifier identifies the input file as a shareable image.

Option	Description
<code>GSMATCH=</code>	Sets the major and minor identification numbers in the shareable image and specifies the algorithm when comparing identification numbers.

Option	Description
PROTECT= ¹	When specified with the YES keyword in a linker options file, this option directs the linker to protect the clusters created by subsequent options specified in the options file. You turn off protection by specifying the PROTECT=NO option in the options file.
SYMBOL_TABLE= ²	When specified with the GLOBALS keyword, this option directs the linker to include in a symbol table file all the global symbols defined in the shareable image, in addition to the universal symbols. By default, the linker includes only universal symbols in a symbol table file associated with a shareable image (SYMBOL_TABLE=UNIVERSALS).
SYMBOL_VECTOR=	Specifies symbols in the shareable image that you want declared as universal.

¹It is recommended to protect the whole image with the /PROTECT qualifier, see Section 4.4.

²The only purpose of a symbol table file is to make symbols and their values known to the System Dump Analyzer (SDA). The option is intended for system developers who use SDA to look at a running system, a process, or crash dump.

4.2. Declaring Universal Symbols in x86-64 and I64 Shareable Images

To illustrate how to declare universal symbols, consider the programs in the following examples. Example 4.1 shows a shareable image test module. Example 4.2 shows the shareable image.

Example 4.1. Shareable Image Test Module: my_main.c

```
#include <stdio.h>
#pragma extern_model save
#pragma extern_model common_block
extern int my_data;
#pragma extern_model restore
extern int my_symbol;
extern int mysub( int, int );
main()
{
    int num1, num2, result;
    num1 = 7;
    num2 = 4;
    result = mysub( num1, num2 );
    printf("Result= %d\n", result);
    printf("Data implemented as overlaid psect= %d\n", my_data);
    printf("Global reference data is= %d\n", my_symbol);
}
```

Example 4.2. Shareable Image: my_math.c

```
#pragma extern_model save
#pragma extern_model common_block
int my_data = 5;
#pragma extern_model restore
int my_symbol = 10;
int add_data = -1;
int sub_data = -1;
int mul_data = -1;
int div_data = -1;
int myadd( int value_1, int value_2 )
{
    add_data = value_1 + value_2;
    return add_data;
}
int mysub( int value_1, int value_2 )
{
```

```

    sub_data = value_1 - value_2;
    return sub_data;}
int mymul( int value_1, int value_2 )
{
    mul_data = value_1 * value_2;
    return mul_data;
}
int mydiv( int value_1, int value_2 )
{
    div_data = value_1 / value_2;
    return div_data;
}

```

You must use the extern common model to make the VSI C for x86-64 or I64 compiler implement the symbol `my_data` as an overlaid section. The default model on VSI C is relaxed/refdef. For more information on the extern models and how they are enabled with pragmas or command qualifiers, see the *VSI C User's Guide for OpenVMS Systems*.

For x86-64 and I64 linking, you declare universal symbols by listing them in a `SYMBOL_VECTOR=` option. For each symbol listed in the `SYMBOL_VECTOR=` option, the linker creates an entry in the shareable image's symbol vector and creates an entry for the symbol in the shareable image's GST. When the shareable image is included in a subsequent link operation, the linker processes the symbols listed in its GST.

To enable images that linked against a shareable image to run with various versions of the shareable image, you must specify the identification numbers of the image. By default, the linker assigns a unique identification number to each version of a shareable image. At run-time, if the ID of the shareable image as it is listed in the executable image does not match the ID of the shareable image the image activator finds to activate, the activation will abort. For information about using the `GSMATCH=` option to specify ID numbers, see the description of the `GSMATCH=` option in Chapter 10.

To implement Example 4.2 as an x86-64 or I64 shareable image, you must declare the universal symbols in the image by using the following LINK command:

```

$ LINK/SHAREABLE MY_MATH, SYS$INPUT/OPT
GSMATCH=LEQUAL,1,1000
SYMBOL_VECTOR=(MYADD=PROCEDURE,-
                MYSUB=PROCEDURE,-
                MYMUL=PROCEDURE,-
                MYDIV=PROCEDURE,-
                MY_SYMBOL=DATA,-
                MY_DATA=PSECT)
Ctrl/Z

```

You must identify the type of symbol vector entry you want to create by specifying a keyword. The linker allows you to create symbol vector entries for procedures, data (relocatable or constant), and for global data implemented as an overlaid section.

A symbol vector entry is two quadwords (on x86-64 systems) or one quadword (on I64 systems) that contain information about the symbol that can be used in subsequent fix-up of images that are linked against the shareable image. The contents of the entry depend on what the symbol represents. If the symbol represents a procedure (`=PROCEDURE`), the symbol vector entry contains the procedure value, that is the function address. If the symbol represents a data item (`=DATA`), the symbol vector entry contains the address of the data location. If the symbol represents a data constant (`=DATA`), the symbol vector entry contains the actual value of the constant. If the symbol represents a section (`=PSECT`), the symbol vector entry contains the address of the location of the section.

The linker fills in the symbol vector with values and addresses. The address calculations are based on the assumption that the shareable image will be mapped at the default base address. This is done

despite the fact that the linker cannot know where the image will be in memory at run-time. The linker also adds relocation information so that the image activator can adjust the address values based on the actual base address of the shareable image at activation time. This way, at run-time the symbol vector contains the actual code or data addresses.

When you create the shareable image (by linking it specifying the `/SHAREABLE` qualifier), the value of a universal symbol listed in the GST is the zero-based index of the symbol in the symbol vector (expressed as index `z` in Figure 4.1 (x86-64) and Figure 4.2 (I64)).

When you include this shareable image in a subsequent link operation, the linker leaves references to the procedure, data or section empty. The linker create fix-ups in the executable image that reference symbols from the shareable image. The fix-up includes the symbol's index in the symbol vector of the shareable image.

The following example illustrates how to link the object module `MY_MAIN.OBJ` with the shareable image `MY_MATH.EXE`.

```
$ LINK MY_MAIN, SYS$INPUT/OPTMY_MATH/SHAREABLE  
Ctrl/Z
```

On x86-64 systems, when an executable image calls a function in a shareable image, the call goes through one or two linker-generated code stubs. In `MY_MAIN.EXE`, the call to `mysub` is redirected by the linker to a PLT stub. The PLT stub consists of a single instruction, an indirect jump through a GOT entry. Using the symbol vector in `MY_MATH.EXE`, the image activator fixes up the GOT entry in `MY_MAIN.EXE` so it contains the procedure value for `mysub`. Since, in this example, the code for `mysub` is located in P2, the procedure value points to another linker-generated stub. This stub does an indirect jump to `mysub` itself.

Figure 4.1. Accessing Universal Symbols Specified Using the SYMBOL_VECTOR=Option on x86-64

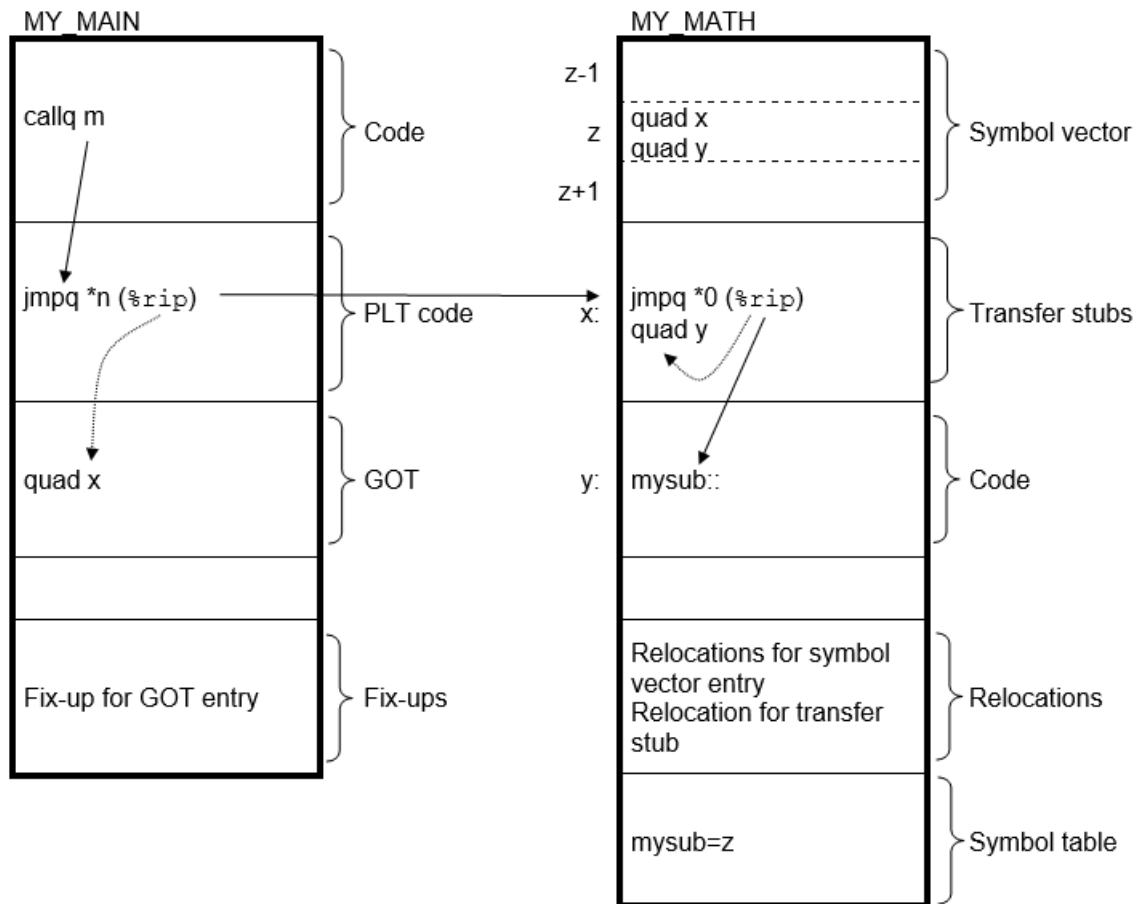

`m` = Offset from end of `callq` instruction to start of PLT entry
`n` = Offset from end of `jmpq` instruction to location of GOT entry
`x` = Address of transfer stub (procedure value)
`y` = Address of procedure
`z` = Symbol vector index

On I64 systems, at run-time, when the image activator maps the shareable image into memory, it calculates the actual locations of the routines and relocatable data within the image and stores these values in its symbol vector. The image activator then fixes up the references to these symbols in the executable image. For a symbol representing constant data, the constant from the symbol vector is copied into the executable image. For a symbol representing relocatable data, the address of the data from the symbol vector is copied into the executable image. For a symbol representing a procedure the contents of the FD pointed to by the address in the symbol vector, the code address and the global pointer, is copied into the executable image. When the executable image makes a call to the procedure, shown as the branch (`br.few`) instruction sequence in Figure 4.2, control is transferred directly to the location of the procedure within the shareable image.

Figure 4.2. Accessing Universal Symbols Specified Using the SYMBOL_VECTOR=Option on I64

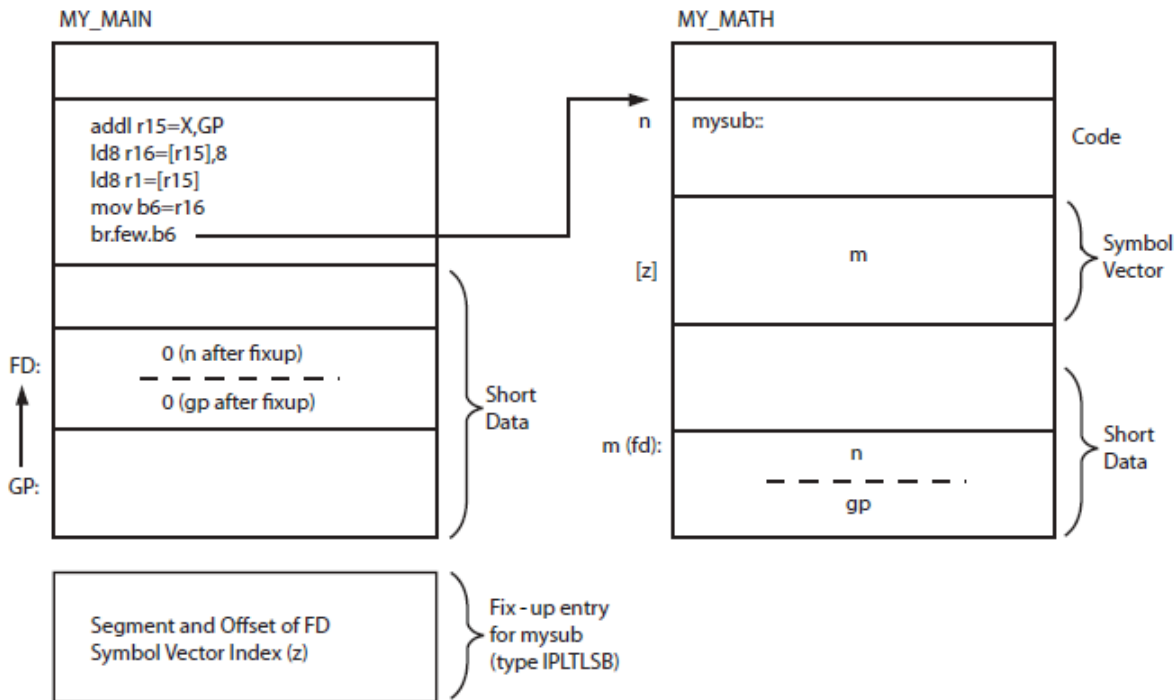

VM-1219A-AI

Note that the images are being activated by the image activator with all relocations applied, pointing out a single fix-up. That is, m and n are the virtual addresses after the image relocations are applied and gp is the relocated global pointer value.

Note also that, unlike VAX linking, global symbols implemented as overlaid sections are not universal by default. Instead, you control which of these symbols is a universal symbol by including it in the SYMBOL_VECTOR=option, specifying the PSECT keyword. The example declares the section my_data as a universal symbol.

4.2.1. Symbol Definitions Point to Shareable Image Sections

On x86-64 and I64 systems, the linker cannot overlay sections that are referenced by symbol definitions with shareable image sections of the same name.

For example, the VSI C compiler generates symbol definitions when the relaxed ref/def extern model is used (the default).

For hard symbol definitions, the compiler creates an overlaid section defining the memory requirements for that symbol. For tentative symbol definitions, there is no virtual memory allocated by the compiler. At link time, if there is no virtual memory for a symbol found, the linker creates an overlaid section defining the memory.

If an overlaid section was created for a symbol definition, such a section cannot be overlaid with shareable image sections that are created when you link a shareable image and use the PSECT keyword in your SYMBOL_VECTOR option. For more information on the extern models, see *VSI C User's Guide for OpenVMS Systems*.

If the linker detects this condition, it issues the following error:

```
%LINK-E-SHRSYMFND, shareable image psect <name> was pointed  
to by a symbol definition  
%LINK-E-NOIMGFIL, image file not created
```

The link continues, but no image is created. To work around this restriction, change the symbol vector keyword to DATA, or recompile your C program with the qualifier /EXTERN=COMMON.

For more information, see the *VSI C User's Guide for OpenVMS Systems*.

If the section specified in a SYMBOL_VECTOR= option does not exist, the linker issues a warning, places zeros in the symbol vector entry and does not create an entry for the section in the image's GST.

The linker maintains separate name spaces for global symbol names and section names. As described in Chapter 2, the section names are not used to resolve an undefined symbol. Because of the different name spaces, it is possible to specify an identical name in a symbol vector option when exporting a global symbol and a section. This depends on the main module's extern model and which entry in the symbol vector resolves or overlays a reference from the main module.

Note

Although this is correct linker behavior, using identical names in this manner can create confusion. As such, VSI discourages the use of this feature.

4.2.2. Creating Upwardly Compatible Shareable Images

The SYMBOL_VECTOR= option allows you to create upwardly compatible shareable images. You can create a shareable image that can be modified, recompiled, and relinked without causing the images that were linked against previous versions of the image to be relinked.

To ensure upward compatibility when using a SYMBOL_VECTOR= option, you must preserve the order and placement of the entries in the symbol vector with each relinking. Do not delete existing entries and only add new entries at the end of the list. If you use multiple SYMBOL_VECTOR= option statements in a single options file to declare the universal symbols, you must also maintain the order of the SYMBOL_VECTOR= option statements in the options file. If you specify SYMBOL_VECTOR= options in separate options files, make sure the linker always processes the options files in the same order. (The linker creates only one symbol vector for an image).

Use the GSMATCH mechanism to record any changes you make. GSMATCH handles the changes as follows:

- Major changes or incompatible changes, different orders of existing symbol vector entries, or deletion of entries most likely will result in a mismatch of the major ID number.
- Minor changes or compatible changes, or addition of new entries should result in a match of the major ID number but in a mismatch of the minor ID number.

By using the major and minor IDs in this manner, along with the LEQUAL keyword, you can create upwardly compatible shareable images. For example, a main image linked against minor ID 2 of a

shareable image is not allowed to run against the shareable image with a minor ID less than 2, if the shareable image was linked with the keyword `LEQUAL`. For more information, see the description of the `GSMATCH=` option in Chapter 10.

4.2.3. Deleting Universal Symbols Without Disturbing Upward Compatibility

To delete a universal symbol without disturbing the upward compatibility of an image, use the `PRIVATE_PROCEDURE` or `PRIVATE_DATA` keywords. In the following example, the symbol `mysub` is deleted using the `PRIVATE_PROCEDURE` keyword:

```
$ LINK/SHAREABLE MY_MATH, SYS$INPUT/OPT
GSMATCH=LEQUAL,1,1000
SYMBOL_VECTOR=(MYADD=PROCEDURE,-
                MYSUB=PRIVATE_PROCEDURE,-
                MYMUL=PROCEDURE,-
                MYDIV=PROCEDURE,-
                MY_SYMBOL=DATA,-
                MY_DATA=PSECT)
```

Ctrl/z

When you specify the `PRIVATE_PROCEDURE` or `PRIVATE_DATA` keyword in the `SYMBOL_VECTOR=` option, the linker creates symbol vector entries for the symbols *but does not create an entry for the symbol in the GST of the image*. The symbol still exists in the symbol vector and none of the other symbol vector entries have been disturbed. Images that were linked with previous versions of the shareable image that reference the symbol still work, but the symbol is not available for new images to link against.

Using the `PRIVATE_PROCEDURE` keyword, you can replace an entry for an obsolete procedure with a private entry for a procedure that returns a message that explains the status of the procedure.

4.2.4. Creating Run-Time Kits

If you use shareable images in your application, you may want to ship a run-time kit with versions of these shareable images that cannot be used in link operations.

To do this, you must first link your application, declaring the universal symbols in the shareable images using the `SYMBOL_VECTOR=` option so that references to these symbols can be resolved. After the application is linked, you must then relink the shareable images so that they have fully populated symbol vectors but empty global symbol tables (GSTs). The fully populated symbol vectors allow your application to continue to use the shareable images at run-time. The empty GSTs prevent other images from linking against your application.

To create this type of shareable image for a run-time kit (without having to disturb the `SYMBOL_VECTOR=` option statements in your application's options files), relink the shareable image after development is completed, specifying the `/NOGST` qualifier on the `LINK` command line. When you specify the `/NOGST` qualifier, the linker builds a complete symbol vector, containing the symbols you declared universal in the `SYMBOL_VECTOR=` option, but does not create entries for the symbols that you declared universal in the GST of the shareable image. For more information about the `/GST` qualifier, see Chapter 10.

4.2.5. Specifying an Alias Name for a Universal Symbol

For x86-64 and I64 linking, a universal symbol can have a name, called a **universal alias**, different from the name contributed by the object module in which it is defined. You specify the universal alias name when you declare the global symbol as a universal symbol using the `SYMBOL_VECTOR=` option. The universal alias name precedes the internal name of the global symbol, separated by a slash (/). In the following example, the global symbol `mysub` is declared as a universal symbol under the name `sub_alias`.

```
$ LINK/SHAREABLE MY_MATH, SYS$INPUT/OPT
GSMATCH=LEQUAL,1,1000
SYMBOL_VECTOR=(MYADD=PROCEDURE,-
                SUB_ALIAS/MYSUB=PROCEDURE,-
                MYMUL=PROCEDURE,-
                MYDIV=PROCEDURE,-
                MY_SYMBOL=DATA,-
                MY_DATA=PSECT)
```

Ctrl/Z

You can specify universal alias names for symbols that represent procedures or data; you cannot declare a universal alias name for a symbol implemented as an overlaid section. In link operations in which the shareable image is included, the calling modules must refer to the universal symbol by its universal alias name to enable the linker to resolve the symbolic reference.

The alias mechanism can also be used to map case sensitive symbols to case insensitive ones. With C and C++, case sensitivity becomes more important. You may want to create a shareable image that contains both symbols, so that object modules from traditional programming languages as MACRO and FORTRAN can link against your image as well as modules which compile from open sources and usually expect case sensitive names. In the following link operation for Example 4.2, for each routine or data, uppercase and lowercase symbols are defined with the alias mechanism, which are written into the GST.

```
$ LINK/SHAREABLE MY_MATH, SYS$INPUT/OPT
CASE_SENSITIVE=YES
SYMBOL_VECTOR=(MYADD=PROCEDURE,-
                myadd/MYADD=PROCEDURE,-
                MYSUB=PROCEDURE,-
                mysub/MYSUB=PROCEDURE,-
                MYMUL=PROCEDURE,-
                mymul/MYMUL=PROCEDURE,-
                MYDIV=PROCEDURE,-
                mydiv/MYDIV=PROCEDURE,-
                MY_SYMBOL=DATA,-
                my_symbol/MY_SYMBOL=DATA,-
                MY_DATA=PSECT)CASE_SENSITIVE=NO
```

Ctrl/Z

In a privileged shareable image, calls *from within the image* that use the alias name result in a fix-up and subsequent vectoring through the privileged library vector (PLV), which results in a mode change. Calls from within the shareable image that use the internal name are done in the caller's mode. (Calls from external images always result in a fix-up). For more information about creating a PLV, see the *VSI OpenVMS Programming Concepts Manual*.

4.3. Improving the Performance of Installed Shareable Images

On x86-64 and I64 systems, you can improve the performance of an installed shareable image by installing it as a resident image (by using the `/RESIDENT` qualifier of the `INSTALL` utility). `INSTALL` loads the executable and read-only segments of resident images into physical memory, with virtual

addresses in system space. Data or code of such images is directly accessed from memory. That is, at run-time image pages do not need to be read from the image file. See the documentation on the Install utility for more information about installing images as resident images.

4.4. Linking User-Written System Services

User-written system services allow user-mode programs to call routines that can perform functions that require privileges. These services are implemented in shareable images. Because of the privileged code, these images are also referred to as **privileged shareable images**. For security reasons, the privileged code and associated data must be protected from manipulations. Therefore, such images are also called **protected shareable images**.

As you would create any other shareable image, create a privileged shareable image by specifying the /SHAREABLE qualifier in the LINK command. However, because the privileged routine entry points in privileged shareable images must be routed through the OpenVMS system service dispatcher in order to change mode to a more privileged mode, declaring these entry points as universal requires additional steps:

- **Protect the privileged shareable image from user-mode or supervisor-mode write access** — Create a protected shareable image by specifying the /PROTECT qualifier. If you need to protect only certain segments in a privileged shareable image, use the PROTECT= option. For more information about this option, see Chapter 10.
- **Create a Privileged Library Vector (PLV) and put it in a protected section** — Create a PLV for a privileged shareable image. The image activator uses the information in the PLV to set up the change of mode code. You can create a protected shareable image by specifying the /PROTECT qualifier. For information about creating a PLV, see the *VSI OpenVMS Programming Concepts Manual*.

Note

On x86-64 and I64 systems, it is recommended to protect the entire image, rather than parts of the image (that is, individual image segments). Partial protection requires that you verify that all data to be protected is in the protected segment. Compilers for x86-64 and I64 put data in different types of sections. By doing so, it becomes difficult to control protection setting.

For example, compilers for I64 put some data into short data sections. The linker then must collect these sections into short data segments, which cannot be collected into user-defined clusters (the only clusters that you can protect with the linker option). That is, for partially protected images, you need control over that location that the compiler puts all your data. The compiler of your choice might not offer a reliable method to do so; therefore, it is recommended to protect the entire image.

Chapter 5. Interpreting an Image Map File (x86-64 and I64)

This chapter describes how to interpret information in an image map created by the linker on OpenVMS x86-64 and OpenVMS I64 systems. It describes the combinations of linker qualifiers used to produce a map.

For information about interpreting an image map file on OpenVMS Alpha and OpenVMS VAX systems, see Chapter 9.

5.1. Overview of x86-64/I64 Linker Map

At your request, the linker can generate information that describes the contents of the image and the linking process. This information, called an **image map**, can be helpful when determining programming and link-time errors, studying the layout of the image in virtual memory, and keeping track of global symbols.

You can obtain the following types of information about an image from its image map:

- The names of all modules included in the link operation, both explicitly in the LINK command and implicitly from libraries
- The names, sizes, and other information about the segments that comprise the image
- The names, sizes, and locations of sections within an image
- The names and values of all the global symbols referenced in the image, including the name of the module in which the symbol is defined and the names of the modules in which the symbol is referenced
- Statistical summary information about the image and the link operation itself

You determine which information the linker includes in a map file by specifying qualifiers in the LINK command line. If you specify the /MAP qualifier, the map file includes certain information by default (called a **default map**). You can also request a map file that contains less information about the image (called a **brief map**) or a map file that contains more information about the image (called a **full map**). Table 5.1 lists the LINK command qualifiers that affect map file production.

Table 5.1. LINK Command Map File Qualifiers

Qualifier	Description
/MAP	Directs the linker to create a map file. This is the default for batch jobs. /NOMAP is the default for interactive link operations.
/BRIEF	When used in combination with the /MAP qualifier, directs the linker to create a map file that contains only a subset of the default map sections.
/FULL	When used in combination with the /MAP qualifier, directs the linker to create a map file that contains extensive information of the image in the map file. To tailor the full information to your needs, you can use keywords to add or suppress specific information. The default value for /FULL is SECTION_DETAILS.

Qualifier	Description
	<ul style="list-style-type: none"> • <code>DEMANGLED_SYMBOLS</code> — Directs the linker to add a translation table of mangled and demangled (source code) names. You can request this section if you use a programming language, whose language processor performs name mangling (for example, Ada and C++) and the compiler provides the necessary information within the object modules. The table contains names of global definitions, procedures and data. Note that <code>/DNI</code> (to process display name information) must be present, which is by default. See Section 5.4 for more information. • <code>GROUP_SECTIONS</code> — Directs the linker to list all processed groups (ELF COMDATs). For example, C++ includes groups in its object modules and shareable images. Note when linking against C++ shareable images, all groups of these images will be listed; even for short programs this will create a long list. • <code>[NO]SECTION_DETAILS</code> — Directs whether or not the linker suppresses zero length contributions in the Program Section Synopsis. • <code>ALL</code> — The <code>ALL</code> keyword is equivalent to specifying all of the above listed keywords.
<code>/CROSS_REFERENCE</code>	When used in combination with the <code>/MAP</code> qualifier, directs the linker to replace the Symbols By Name section with a Symbol Cross-Reference section, in which all the symbols in each module are listed with the modules in which they are called. You cannot request this type of listing in a brief map file.

5.2. Components of an x86-64/I64 Image Map File

The linker formats the information it includes in a map file into sections. Table 5.2 lists the sections of a map file in the order in which they appear in the file. The table also indicates whether the section appears in a brief map, full map, or default map file.

Table 5.2. x86-64/I64 Image Map Sections

Section Name	Description	Default Map	Full Map	Brief Map
Object and Image Synopsis ¹	Lists all the object modules included in the image and the shareable images referenced in the order they are processed by the linker.	Yes	Yes	Yes
Cluster Synopsis	Lists all the clusters created by the linker	—	Yes	—
Image Segment Synopsis	Lists the image segments that were created	—	Yes	—
COMDAT Group Synopsis	Lists the processed groups ordered by group name	—	Keyword <code>GROUP_SECTIONS</code>	—

Section Name	Description	Default Map	Full Map	Brief Map
Program Section Synopsis ¹	Lists the sections and their attributes.	Yes	Yes	—
Symbol Cross Reference ¹	Lists each symbol name, its value, the name of the module that defined it, and the names of the modules that refer to it.	Yes /CROSS	Yes /CROSS	—
Symbols By Value	Lists all the symbols with their values in hexadecimal representation.	—	Yes	—
Cross Reference Footnotes	If the cross reference or the symbol value lists contain shortened name, this section is automatically created and the full names are listed.	Yes	Yes	—
Mangled/ Demangled Symbols	Lists all the mangled symbols with their demangled (source code) names.	—	Keyword DEMANGLED_ SYMBOLS	—
Image Synopsis	Presents statistics and other information about the output image.	Yes	Yes	Yes
Link Run Statistics	Presents statistics about the link run that created the image. Quota usage keeps track of quotas being used by the linker and may suggest which quota should be increased to improve performance.	Yes	Yes	Yes

¹In a full map file, these sections include information about modules that were included in the link operation from libraries but were not explicitly specified on the LINK command line.

5.2.1. Object and Image Synopsis Section

The first section that appears in a map file is the Object and Image Synopsis, which lists the name of each object or shareable image included in the link operation in the order in which they were processed. This section of the map file also includes other information about each module, arranged in columns. Example 5.1 shows the Object and Image Synopsis map.

This section corresponds to the OpenVMS Alpha section titled Object Module Synopsis. To compare with the linker map on Alpha, see Section 9.2.1.

Example 5.1. Object and Image Synopsis

```

+-----+
! Object and Image Synopsis !
+-----+

❶      ❷      ❸      ❹      ❺      ❻
Module/Image  File          Ident          Attributes      Bytes  Creation Date  Creator
-----
GETJPI              V1.0              Lkg  Dnrm      280  8-MAR-2019 15:50  VSI C X7.4-151
                DISK$USER:[JOE]GETJPI.OBJ;1
DECC$SHR              V8.3-00          Lkg              0  28-FEB-2019 10:57  Linker I02-68
                SYS$COMMON:[SYSLIB]DECC$SHR.EXE;1
SYS$PUBLIC_VECTORS  X-3              Sel Lkg              0  28-FEB-2019 10:56  Linker I02-68
                SYS$COMMON:[SYSLIB]SYS$PUBLIC_VECTORS.EXE;1

Key for Attributes
+-----+
! Sel - Module was selectively searched !
! Lkg - Contains call linkage information !
! Dnrm - Denormal IEEE FP model !
+-----+

```

- ❶ **Module/Image.** The name of each object module or shareable image included in the link operation. The modules/images are listed in the order in which the linker processed them. (Note that the order of processing can be different from the order in which the files were specified in the command line. For more information about how the linker processes input files, see Chapter 2). If the linker encounters an error during its processing of an object module or shareable image, an error message appears on the line directly following the line containing the name of that module or image.
- ❷ **File.** Full file specification of the input file, including device and directory. The specification is printed on a separate line. It starts at the File column and continues across the other columns. If the specification is longer than 111 characters, it is shortened by dropping the device portion of the file specification or both the device and directory portions of the file specification.
- ❸ **Attributes.** The attributes displays four subcolumns of module attributes. An explanation of the abbreviations used appears in the Key for Attributes legend that appears at the end of the Object and Image Synopsis section:

The first of the four subcolumns indicates whether the symbol search of the module was selective. If the symbol search was selective, the abbreviation *Sel* appears. If the symbol search of the module was not selective, this subcolumn is left blank.

The second subcolumn indicates whether the module has call linkage information. If the module has call linkage information, *Lkg* appears. If the module does not have call linkage information, this subcolumn is left blank.

The third subcolumn indicates whether the module was compiled with the Reduced Floating Point model. If it was, the abbreviation *RFP* appears. If the module was not compiled with the Reduced Floating Point model, this subcolumn is left blank. This designation is suppressed for shareable images.

The fourth subcolumn indicates the whole program Floating Point mode for the module. Several abbreviations can appear in this column. For example *Dnrm*, the denormal IEEE FP model.

The following example lists all of the possible abbreviations for this subcolumn in the Keys for Attributes legend. The Bytes, Creation Date and Creator columns are omitted from this example; refer to the preceding map example for the entire Object and Image Synopsis.

Module/Image	File	Ident	Attributes
NONE		V1.0	Lkg
NOFLOAT_CASE	DISK1:[JOE]NONE.OBJ;1		Lkg RFP
DNORM_CASE	DISK1:[JOE]NOFLOAT.OBJ;1		Lkg Dnrm
FAST_CASE	DISK1:[JOE]DENORM_W.OBJ;1		Lkg Fast
NEPCT_CASE	DISK1:[JOE]FAST_W.OBJ;1		Lkg Inex
SPCL_CASE	DISK1:[JOE]INEXACT_W.OBJ;1		Lkg Spcl
UNDER_CASE	DISK1:[JOE]SPECIAL_W.OBJ;1		Lkg Undr
DG_FL_CASE	DISK1:[JOE]UNDERFLOW_W.OBJ;1		Lkg VXfl
DECC\$SHR	DISK1:[JOE]VAXFLOAT_W.OBJ;1	V8.2-00	Lkg
SYS\$PUBLIC_VECTORS	RESO\$:[SYSLIB]DECC\$SHR.EXE;1	X-2	Sel Lkg
	RESO\$:[SYSLIB]SYS\$PUBLIC_VECTORS.EXE;1		

Key for Attributes

```

+-----+
! Sel - Module was selectively searched !
! Lkg - Contains call linkage information !
! RFP - Conforms to the reduced FP model !
! VXfl - VAX Float FP model !
! Dnrm - Denormal IEEE FP model !
! Fast - Fast IEEE FP model !
! Inex - Inexact IEEE FP model !
! Undr - Underflow-to-zero IEEE FP model !
! Spcl - Special FP model !
+-----+

```

- ④ Bytes. The number of bytes the object module contributes to the image. Because shareable images do not contribute to the image the value 0 (zero) appears in this column.
- ⑤ Creation Date. The date and time the module or image was created.
- ⑥ Creator. Identification of the language processor or other utility that created the module or image.

5.2.2. Cluster Synopsis Section

The Cluster synopsis section (Example 5.2) shows clusters that were created for and used by the linker, the order in which they were processed, and Global Section Match (GSMATCH) criteria.

Example 5.2. Cluster Synopsis

```

+-----+
! Cluster Synopsis !①
+-----+

② Cluster          ③ Match      Majorid  Minorid
-----
MYCLU
DEFAULT_CLUSTER
DECC$SHR          LESS/EQUAL    1         1
SYS$PUBLIC_VECTORS EQUAL         9525     361572293

```

- ① Cluster Synopsis. On x86-64 and I64 systems, there are separate map sections titled Cluster Synopsis and Image Segment Synopsis. The Cluster Synopsis section on x86-64 and I64 does not contain segment information.

- ② Cluster. The Cluster column shows the names of the clusters created for and used by the linker, and the order in which they were processed. STARLET.OLB is an exception. It is on the default cluster but its processing is postponed after processing IMAGELIB.OLB. See Chapter 2 for more information on processing default libraries.
- ③ Match, Majorid, and Minorid. The Match, Majorid, and Minorid columns show the GSMATCH criteria along with the major and minor version numbers, if this information is available. For more information, see the GSMATCH= option in Chapter 10.

5.2.3. Image Segment Synopsis Section

The Image Segment Synopsis section of the linker map file (Example 5.3) lists the image segments created by the linker. The image segments appear in the order in which the linker created them. The order of the segments depends on the order of the clusters as shown in the linker's image cluster synopsis (see Section 5.2.2). On x86-64 and I64 systems, segments of the shareable images which are included in the link operation are not listed in the Image Segment Synopsis.

This section of the image map includes other information about the image segments, formatted in columns. To compare with the Alpha Image Section Synopsis map, see Section 9.2.3.

Example 5.3. Image Segment Synopsis

```

+-----+
! Image Segment Synopsis !①
+-----+

```

② Seg#	③ Cluster	④ Type	⑤ Pglts	⑥ Base Addr	⑦ Disk VBN	⑧ PFC	⑨ Protection	⑩ Attributes
0	MYCLU	LOAD	1	00010000		2	0	READ WRITE
1		LOAD	1	00020000		0	0	READ WRITE DEMAND ZERO
2		LOAD	1	00030000		3	0	READ ONLY EXECUTABLE, SHARED
3		LOAD	1	00040000		4	0	READ ONLY SHARED
4		LOAD	1	00050000		5	0	READ ONLY [UNWIND]
5	DEFAULT_CLUSTER	LOAD	1	00060000		6	0	READ ONLY SHORT ^①
6		DYNAMIC	2	Q-00000000 80000000		7	0	READ ONLY

Key for special characters above

```

+-----+
! Q - Quad Value !
+-----+

```

- ① The Image Segment Synopsis section shows each segment as it was created.
- ② Seg#. The image's segment number, indicating segments in the order the linker created them and used in image relocations and image fix-ups that are applied to a segment by the image activator.

Using the ANALYZE/IMAGE/SEGMENT=DYNAMIC command, you can format the dynamic segment, which includes the image relocations and fix-ups. The following extract of the ANALYZE shows how the segment numbers are used for image relocations:

```

Segment Offset Modified: 0000000000000050 imr$q_rela_offset
Image Relocation Type: 00000081 imr$l_type
Segment Being Modified: 00000003 imr$l_rela_seg
Image Relocation Addend: 0000000000000000 imr$q_addend
Symbol Segment Offset: 0000000000000000 imr$q_sym_offset
Symbol Segment Number: 00000000 imr$l_sym_seg
Virtual Address Affected: 0000000000040050

```

- ③ Cluster. The name of each cluster the linker created, listed in the order in which the linker created them. For better readability, the cluster name is only shown for the first segment in the cluster.

- ④ Type. The type of the segment, indicating if a segment will be in memory at run-time (LOAD), or if the segment is used to activate the image (DYNAMIC).
- ⑤ Pagelets. The length of each segment, expressed in pagelets (512-byte quantities).
- ⑥ Base Address. The base address assigned to the segment. Note that all segments are relocatable, the image activator may relocate the base address.
- ⑦ Disk VBN (virtual block number). The virtual block number of the image file on disk where the segment begins. The number 0 indicates that the segment is not in the image file. This is the case for demand-zero segments.
- ⑧ Page fault cluster (PFC). The number of pagelets read into memory by the operating system when the initial page fault occurs for that segment. The number 0 indicates that the system parameter PFCDEFAULT determines this value, rather than the linker.
- ⑨ Protection. The protection attributes of the segment:

Keyword	Meaning
READ ONLY	Indicates that the segment is protected against write access.
READ WRITE	Indicates that the segment allows both read and write access.

- ⑩ Attributes. A keyword phrase that characterizes the settings of certain attributes of the image segment, such as the attributes that affect paging.

The following table lists the keywords used by the linker to indicate these characteristics of an image segment:

Keyword	Meaning
DEMAND ZERO	Indicates that the segment is a demand-zero segment. For more information, see Section 3.4.4.
DZRO COMPRESSED	Indicates that a segment had the trailing pagelets containing zeros compressed. For more information, see Section 3.4.4.
EXECUTABLE	Indicates that the segment contains code.
FIXED OFFSET ¹	Indicates that this segment position relative to the previous segment must be maintained when the image is loaded and activated.
PROTECTED	Indicates that a segment at run-time will be protected from user-mode and supervisor-mode write access. The image activator ensures the protection when the segment is in memory. For more information, see Section 4.4.
SHARED	Indicates that a segment can be shared between several processes.
SHORT ²	Indicates a short data segment, data which is addressed with small offsets from the global pointer. For more information, see Section 3.4.3.3.
VECTOR	Indicates that a segment contains privileged change-mode vectors or message vectors.
[UNWIND]	Indicates that a segment contains unwind information. Please note that UNWIND is not an attribute. The linker flags this segment for better readability because all other attributes may be identical to other segments. For more information, see Section 3.2.1.5.

¹x86-64 specific

²I64 specific

The linker may use more than one keyword to describe a segment. For example, to describe a segment that contains code, the linker uses the READ ONLY and EXECUTABLE keywords.

- ① (I64 specific) If the module was compiled with /TIE and the image is linked /NONATIVE_ONLY and if the image contains nonstandard signatures, a separate segment appears immediately after the short data segment that contains them.

5.2.4. Program Section Synopsis Section

The Program Section Synopsis section lists the sections that comprise the image, along with information about the size of the section, its starting- and ending-addresses, and its attributes. The Module Name column in this map section lists the modules that contribute to each section. Example 5.4 shows the Program Section Synopsis.

Example 5.4. Program Section Synopsis

```

+-----+
! Program Section Synopsis !
+-----+

```

Psect Name ^①	Module/Image ^②	Base ^③	End ^④	Length ^⑤	Align ^⑥	Attributes ^⑦
ITMLET		00010000	0001000F	00000010 (16.) OCTA 4	OVR,REL,GBL,NOSHR,NOEXE, WRT,NOVEC, MOD
	GETJPI	00010000	0001000F	00000010 (16.) OCTA 4	Initializing Contribution ^⑧
FILLEN		00020000	00020003	00000004 (4.) OCTA 4	OVR,REL,GBL,NOSHR,NOEXE, WRT,NOVEC,NOMOD
	<Linker> ^⑨	00020000	00020003	00000004 (4.) OCTA 4	
FILLM		00020010	00020013	00000004 (4.) OCTA 4	OVR,REL,GBL,NOSHR,NOEXE, WRT,NOVEC,NOMOD
	<Linker>	00020010	00020013	00000004 (4.) OCTA 4	
IOSB		00020020	00020023	00000004 (4.) OCTA 4	OVR,REL,GBL,NOSHR,NOEXE, WRT,NOVEC,NOMOD
	<Linker>	00020020	00020023	00000004 (4.) OCTA 4	
STATUS		00020030	00020033	00000004 (4.) OCTA 4	OVR,REL,GBL,NOSHR,NOEXE, WRT,NOVEC,NOMOD
	<Linker>	00020030	00020033	00000004 (4.) OCTA 4	
\$CODE\$		00030000	0003015F	00000160 (352.) OCTA 4	CON,REL,LCL, SHR, EXE,NOWRT,NOVEC, MOD
	GETJPI	00030000	0003015F	00000160 (352.) OCTA 4	
\$LINKER C\$0		00030160	0003019F	00000040 (64.) OCTA 4	CON,REL,LCL, SHR, EXE,NOWRT,NOVEC, MOD
	<Linker> ^⑩	00030160	0003019F	00000040 (64.) OCTA 4	
\$LITERAL\$		00040000	00040012	00000013 (19.) OCTA 4	CON,REL,LCL, SHR,NOEXE,NOWRT,NOVEC, MOD
	GETJPI	00040000	00040012	00000013 (19.) OCTA 4	
\$LINKER UNWIND\$		00050000	0005002F	00000030 (48.) QUAD 3	CON,REL,LCL,NOSHR,NOEXE,NOWRT,NOVEC, MOD
	GETJPI	00050000	0005002F	00000030 (48.) QUAD 3	
\$LINKER UNWINFOS		00050030	0005005F	00000030 (48.) QUAD 3	CON,REL,LCL,NOSHR,NOEXE,NOWRT,NOVEC, MOD
	GETJPI	00050030	0005005F	00000030 (48.) QUAD 3	
\$LINKER SYMBOL_VECTOR\$		00060000	00060007	00000008 (8.) OCTA 4	CON,REL,GBL,NOSHR,NOEXE,NOWRT,NOVEC, MOD,SHORT
	<Linker Option>	00060000	00060007	00000008 (8.) OCTA 4	
\$LINKER SDATA\$		00060008	000600AF	000000A8 (168.) OCTA 4	CON,REL,GBL,NOSHR,NOEXE,NOWRT,NOVEC, MOD,SHORT
	<Linker>	00060008	000600AF	000000A8 (168.) OCTA 4	

There are two types of line entries: first type is a section entry (Psect Name); the second type are individual module contributions to that section (Module/Image).

- ① Psect Name. The name of each section in the image in ascending order of its base virtual address.
- ② Module/Image. The names of the modules that contribute to the section whose name appears on the line directly above in the Psect Name column. If a shareable image appears in this column, the section is overlaid onto the section in the shareable image.
- ③ Base. The starting virtual address of the section or of a module that contributes to a section. If the section is overlaid onto a section in a shareable image, the virtual address is taken from the shareable image.
- ④ End. The ending virtual address of the section or of a module that contributes to a section. If the section is overlaid onto a section in a shareable image, the virtual address is taken from the shareable image.
- ⑤ Length. For the section entry line, the total length of the section in bytes; for the individual module contribution lines, the length of the individual contribution in bytes.
- ⑥ Align. The type of alignment used for the entire section or for an individual section contribution. The alignment is expressed in two ways. In the first column, the alignment is expressed using a predefined keyword, such as OCTA. In the second column, the alignment is expressed as an integer that is the power of 2 that creates the alignment. For example, octaword alignment would

be expressed as the keyword OCTA and as the integer 4 (because $2^4 = 16$). For more information on the effects of alignment with the PSECT= option see Chapter 10.

If the linker does not support a keyword to express an alignment, it puts the text “2 **” in the column in which the keyword usually appears. When read with the integer in the second column, it expresses these alignments, such as $2^5 = 32$.

- ⑦ Attributes. The attributes associated with the section. For a complete list of all the possible attributes, see Chapter 3.
- ⑧ The linker indicates which modules made initializations (if there were any) to sections which have the attributes OVR, REL and GBL with the designation Initializing Contribution. If you get multiple initialization errors, the linker will have two or more sections marked with the designation Initializing Contribution, in order to help you debug an instance that has many contributors.
- ⑨ The linker contributes storage for common or relaxed ref/def symbols. It is marked with <Linker> under the Module/Image header. The section name is always named after the symbol. (In this example map the C module was compiled with the default switch /EXTERN=RELAXED, and the variables ITMLST, FILLEN, FILLIM and IOSB are relaxed ref/def symbols).
- ⑩ The linker makes a contribution to the code section containing trampolines (instructions with larger branches within the same code segment) or code to branch to another segment (either inside or outside the image). It is marked with <Linker> under the Module/Image header.

Note

If a routine is extracted from the default system library to resolve a symbolic reference, the Program Section Synopsis section in a full map contains information about the program sections comprising that routine. The Program Section Synopsis section in a default map does not.

5.2.5. Symbol Cross-Reference Section

The Symbol Cross-Reference section is a superset of the Symbols By Name section. It is produced in place of the Symbols By Name section when you specify the /CROSS_REFERENCE qualifier. It lists all symbols referenced in the image, along with the module in which they are defined and with all the modules that reference them. Example 5.5 shows how the Symbol Cross-Reference Section formats this information.

Example 5.5. Symbol Cross-Reference

① Symbol	② Value	③ Defined By	④ Referenced By ...
-----	-----	-----	-----
DECC\$TXPRINTF	00000496-X⑤	DECC\$SHR	GETJPI
ELF\$TFRADR	00060050-R	WK-GETJPI	
FILLEN	00020000-R	GETJPI	GETJPI
FILLM	00020010-R	GETJPI	GETJPI
GETJPI (U)	00000000	<Linker Option>	
INTERNAL_GETJPI	00060098-R	GETJPI	
IOSB	00020020-R	GETJPI	GETJPI
ITMLST	00010000-R	GETJPI	
STATUS	00020030-R	GETJPI	GETJPI
SYS\$GETJPIW	0000009A-X	SYS\$PUBLIC_VECTORS	GETJPI

```
+-----+
! Symbol Cross Reference !
+-----+
```

- ❶ Symbol. The name of the global symbol.
- ❷ Value. The value of the global symbol, expressed in hexadecimal. The linker appends characters to the end of the symbol value to describe other characteristics of the symbol. For an explanation of these symbols, see Section 5.2.6.
- ❸ Defined By. The name of the module in which the symbol is defined. For example, the symbol ITMLST is defined in the module named GETJPI.
- ❹ Referenced By... . The name or names of all the modules that contain at least one reference to the symbol.
- ❺ On x86-64 and I64 systems, the designation of an external symbol is always X (external). The linker can not know whether or not an external symbol is relocatable or not. As a result, the designation R (relocatable) can not be attached.

5.2.6. Symbols By Value Section

The Symbols By Value section lists all the global symbols in the image in ascending order by value. The linker formats the information into columns. Example 5.6 shows the Symbols By Value map section.

Example 5.6. Symbols by Value

```

+-----+
! Symbols By Value !
+-----+

❶ Value          ❷ Symbols...
-----          -----
00000000        GETJPI (U)
0000009A        X-SYS$GETJPIW
00000496        X-DECC$TXPRINTF
00010000        R-ITMLST
00020000        R-FILLEN
00020010        R-FILLM
00020020        R-IOSE
00020030        R-STATUS
00060050        R-ELF$TFRADR
00060098        R-INTERNAL_GETJPI

Key for special characters above❸
+-----+
! * - Undefined  !
! (U) - Universal !
! R - Relocatable !
! X - External   !
! C - Code Address !
! WK - Weak      !
! UxWk - Unix-Weak !
+-----+
```

- ❶ Value. The value of each global symbol, expressed in hexadecimal, in ascending numerical order.
- ❷ Symbols... . The names of the global symbols. If more than one symbol has the same value, the linker lists them on more than one line. The characters prefixed to the symbol names indicate other characteristics of the symbol, such as its scope.
- ❸ Keys for Special Characters. The keys for special characters used in the Symbols column are defined as follows:
 - On x86-64 and I64, the special character C appears for code address. On I64, when a function does not have a function descriptor assigned by the linker, its value is its code address.

- On x86-64 and I64 systems, universal symbols appear once with a suffix of (U) defined by <Linker Option> to indicate the external value, and again, possibly with the prefix or suffix R, that indicates their internal value. The external value is the index into the symbol vector. If you had a symbol vector with an alias name, the alias name appears with the universal value, and the internal name appears with the internal value.

For example:

```
symbol_vector=(getjpi/internal_getjpi=procedure)
```

yields:

```
00000000      GETJPI (U)
00050098      R-INTERNAL_GETJPI
```

Note that the OpenVMS Alpha prefixes and suffixes A and I (for Alias and Internal) are not used by OpenVMS x86-64 and I64.

- WK designates a weak symbol.
- UxWk designates a UNIX-style weak symbol, which is similar to an OpenVMS weak symbol. However, more than one symbol with a UNIX-style weak definition can be processed when linking multiple modules without producing a multiple definitions error. UNIX-style weak symbols are currently produced by the C++ compiler. For more information about symbol types, see Chapter 2.

5.2.7. Image Synopsis Section

The Image Synopsis section contains miscellaneous information about the image, such as its name and identification numbers, and a summary of various attributes of the image, such as the number of files used to build the image. Example 5.7 illustrates the format of this section of a map file. The list following the example provides more information about items in this section that are not self-explanatory.

Example 5.7. Image Synopsis

```

+-----+
! Image Synopsis !
+-----+

Virtual memory allocated:①      00010000 0006FFFF 00060000 (393216. bytes, 768. pages)
64-Bit Virtual memory allocated:② 00000000 00000000 00000000
                                80000000 80010000 00010000 (65536. bytes, 128. pages)
                                0. pages
Stack size:③
Image header virtual block limits:④      1.      1. ( 1. block)
Image binary virtual block limits:⑤      2.      8. ( 7. blocks)
Image name and identification:      GETJPI V1.0
Number of files:      5.
Number of modules:      3.
Number of program sections:      8.
Number of global symbols:      3364.
Number of cross references:      17.
Number of image segments:      7.
Transfer address from module:      GETJPI
User transfer FD address:⑥      00000000 00060050
User transfer code address:⑦      00000000 00030000
Initial FP mode:      00000000 09800000 (IEEE DENORM_RESULTS)
Number of code references to shareable images:      2.
Image type:      SHAREABLE. Global Section Match=EQUAL, Ident, Major=9533, Minor=3817251083
Reduced Floating Point model (RFP):      Image does not use RFP model
Map format:      FULL WITH CROSS REFERENCE in file DISK$USER:[JOE]GETJPI.MAP;1
Estimated map length:      443. blocks

```

- ❶ Virtual memory allocated. This line contains the following information:
 - The starting address of the image (base address)
 - The ending address of the image
 - The total size of the image, expressed in bytes, in hexadecimal radix

The numbers in parentheses at the end of the line indicate the total size of the image, expressed in bytes and in pagelets. Both these values are expressed in decimal.

- ❷ 64-Bit Virtual memory allocated. The next two lines contain information on the image portions in P2 space. The virtual addresses are printed by column, in two rows, with the high order digits in the first row. The values are as in the preceding line: the starting-address, the ending-address, the size.

Sections with the attribute `ALLOC_64BIT` are collected into P2 space (For more information on collecting sections and assigning virtual addresses see Chapter 3). The linker usually places the image activator information (dynamic segment) into the 64-bit space. Therefore, for all x86-64 and I64 images, 64-bit virtual memory is usually allocated.

- ❸ Stack size.
- ❹ Image header virtual block limits. For x86-64 and I64 images, the header blocks contain the ELF header and the segment header table. This is usually one disk block.
- ❺ Image binary virtual block limits. For x86-64 and I64 images, the binary blocks contain the image binaries (the segments) and other sections, depending on the type of image. There can be traceback and debug information as well as symbol tables. Also, the section header table describing such sections is counted here.
- ❻ (I64 specific) User transfer FD address. The virtual address of the function descriptor (FD) for the main entry. This is an address in the short data segment.
- ❼ User transfer code address. The virtual address of the first code instruction in the main entry. This is an address in an executable segment.

5.2.8. Link Run Statistics Section

The Link Run Statistics section contains miscellaneous statistical information about the link operation, such as performance indicators. Example 5.8 shows the formatting of this section.

Note that the link command line and the linker options are part of the Link Run Statistics Section.

Example 5.8. Link Run Statistics

```

+-----+
! Link Run Statistics !
+-----+

Performance Indicators                               Page Faults   CPU Time       Elapsed Time
-----
Command processing:                                52            00:00:00.01    00:00:00.00
Pass 1:                                             187           00:00:00.01    00:00:00.01
Allocation/Relocation:                             10            00:00:00.01    00:00:00.02
Pass 2:                                             537           00:00:00.00    00:00:00.00
Write program segments:                             15            00:00:00.01    00:00:00.05
Symbol table output:                                3             00:00:00.00    00:00:00.06
Map data after object module synopsis:              6             00:00:00.00    00:00:00.01
Total run values:                                  810           00:00:00.04    00:00:00.17

Quota usage❶                                         ByteCount      FileCount      PgFlCount
-----
Available:                                           255616         128            700000

```

Command processing:	384	3	7040
Pass 1:	384	3	9504
Allocation/Relocation:	576	4	9504
Pass 2:	384	3	17824
Write program segments:	576	4	17952
Symbol table output:	384	3	17952
Map data after object module synopsis:	384	3	17952

Using a working set limited to 18784 pages and 11105 pages of data storage (excluding image)

Number of modules extracted explicitly = 0
with 0 extracted to resolve undefined symbols

1 library searches were for symbols not in the library searched^②

A total of 1 global symbol table entries was written^③

```
LINK/MAP/FULL/CROSS/SHARE GETJPI/OPT
<DISK$USER:[JOE]GETJPI.OPT;1>
cluster=myclu,,getjpi.obj
symbol_vector=(getjpi/internal_getjpi=procedure)③
```

- ① Quota usage. For x86-64 and I64, includes Quota usage information in the Link Run Statistics section. This information can help you to keep track of the quotas that are being used by the linker. If quota issues occur, the linker is usually able to work around them. However, the linker outputs a special message to the Quota Usage section indicating what quota should be increased to improve performance. For example:

```
Performance of this link operation could be improved by increasing quotas
Quota related to status return: %SYSTEM-SECTBLFUL, process or global
section table is full
2688 extra file I/O operations performed due to current process quota(s)
36 performed on object files; 2652 performed on library files
```

- ② Library searches were for symbols not in the library searched. When resolving undefined symbols, libraries are searched for definitions (see Chapter 2 for more information on symbol resolution). The printed number shows how often undefined symbols are not found in a library. For example, assume that module MAIN references the symbols MY_ADD and MY_SUB, which are defined by modules in ADDLIB.OLB and SUBLIB.OLB. Using the link command:

```
$ LINK MAIN, MAINLIB/LIB, ADDLIB/LIB, SUBLIB/LIB
```

if the MY_ADD and MY_SUB symbols are not found in MAINLIB, MY_SUB is not found in ADDLIB. This results in "3 library searches for symbols not in the library searched".

- ③ The number of global symbols written into a shareable image corresponds to the procedure and data entries in the symbol vector option. In this example, there is only a single entry in the symbol vector option.

5.3. Shortened Names with Footnotes in the Cross-Reference

Some sections of the linker map have tables with a fixed amount of space for their columns. The Symbol Cross-Reference and the Symbols By Value map sections are examples. If names exceed the given column size, the linker prints a shortened name. On x86-64 and I64, for the cross reference and the symbol value list the linker attaches a footnote, referring to the full name. If there are footnotes attached to any name, the linker automatically adds a Cross-Reference Footnotes section. The footnote section contains the footnote index and the full name, wrapped to several lines, if necessary.

The following example demonstrates how to read the footnotes. The long names were constructed for demonstration purpose only. In Example 5.9, the qualifiers /MAP/CROSS/FULL were specified to get both the cross-reference and the symbol value list.

Example 5.9. Shortened Symbol and Module Names

```

+-----+
! Symbol Cross Reference !
+-----+
❶
Symbol                               Value                               Defined By                               Referenced By ...
-----                               -
a_very_very_very_very_very_very_very_very_very_very_very_very_very_very_very_very_very_very_very_long_variable_name...[1]
                                00010000-R                               A_VERY_LONG_MODULE_NAME_JUST_F...[2]

+-----+
! Symbols By Value !
+-----+
❸
Value                               Symbols...
-----                               -
00010000                               R-a_very_very_very_very_very_very_very_very_very_very_very_very_very_very_very_very_very_very_very_lon...[1]

```

- ❶ In the symbol cross reference, the symbol name does not fit on one line. The name is shortened, which is shown with the trailing ellipses. And index of the footnote is in the rightmost column.
- ❷ In the symbol cross reference, the module name exceeds the size for the column Defined By. Again, ellipses show that the name is shortened and an index of the footnote is attached.
- ❸ The same symbol shows in the Symbols By Value section. Even less space is provided to fit the symbol into the Symbols... column. The name, therefore, is shortened with ellipses and a footnote index is attached. Because this is the same symbol as in the Cross-Reference Section (although more shortened), the same index points to the same full name, and the entry in the footnote section.

Example 5.10 shows an example of a Cross Reference Footnotes section, automatically added by the linker.

Example 5.10. Cross Reference Footnotes

```

+-----+
! Cross Reference Footnotes !
+-----+
❶
Index  Full Symbol Name
-----
1  a_very_very_very_very_very_very_very_very_very_very_very_very_very_very_very_very_very_very_very_long_variable_name
   _used_only_for_demonstration_purpose
2  A_VERY_LONG_MODULE_NAME_JUST_FOR_DEMO

```

- ❶ In this example, the full name does not fit into the footnote column. The full symbol name will be wrapped to multiple lines, as necessary.

5.4. Translation Table for Mangled Names

Some compilers mangle symbol names to implement language features (for example, overloading) or to use shortened, unique names. Ada and C++ compilers, for example, do so. The linker receives only **mangled names** from the compilers for resolving symbols and for exporting universal symbols. There is no general rule to derive a mangled name from a source codename or vice versa. If you need to know the source code name for a given mangled name, you need the **demangler** support from that programming language processor.

Recent compilers are able to add demangling information to the object modules. With this information and the language specific demangler routines (usually available with run-time libraries), the linker can create a translation table for mangled names. To obtain this table, use the DEMANGLED_SYMBOLS keyword for the /FULL qualifier when requesting a map. The linker lists all the global symbol definitions from the input object modules with their source code names. Example 5.11 shows a translation table in the linker map.

Example 5.11. Mangled/Demangled Symbols

```

+-----+
! Mangled/Demangled Symbols !
+-----+

Symbol = Source Code Name
-----
CX3$ZN4RW22RWRDNRYXCHNGI2LM6VES❶
= "int __rw::__rw_ordinary_exchange<int, int>(int&, int const&)"
CX3$_Z10DESCENDINGRIS_2OLL9N5
= "descending(int&, int&)"❷
CX3$_Z6MYSWAPIIEVRT_S1_1658A7V
= "void myswap<int>(int&, int&)"❷
CX3$_Z9ASCENDINGRIS_162K6TK
= "ascending(int&, int&)"❷
CXXL$ZN4RW10RWGARDCLERN3D2
= "__rw::__rw_guard::$_complete$__rw_guard(__rw::__rw_mutex_base&)"
CXXL$ZN4RW10RWGARDC2EPNS05KBR8A
= "__rw::__rw_guard::$_subobject$__rw_guard(__rw::__rw_mutex_base*)"
CXXL$ZN4RW10RWGARDC9EPNS20LCU4S
= "__rw::__rw_guard::__rw_guard(__rw::__rw_mutex_base*)"
CXXL$ZN4RW10RWGARDC9ERN3D2
= "__rw::__rw_guard::__rw_guard(__rw::__rw_mutex_base&)"
CXXL$ZN4RW17RWSTTCMTXB8C19J9SHI
= "__rw::__rw_static_mutex<bool>::_C_mutex"
CXXL$ZN4RW17RWSTTCMTXJ8C1AJH16C
= "__rw::__rw_static_mutex<unsigned int>::_C_mutex"
CXXL$ZN4RW20RWTMXCXCHNGII0DCUDA8
= "int __rw::__rw_atomic_exchange<int, int>(int&, int const&, __rw::__rw_mutex_base&)"
CXXL$ZLNKST15BSCSTRAMBFC03029KV
= "std::basic_streambuf<char, std::char_traits<char> >::_C_write_avail() const"
CXXL$ZLNKST5CTYPEICE5WDNC2S864U0
= "std::ctype<char>::widen(char) const"

```

- ❶ The translation table is sorted by the mangled names. Sorting the names by the source code name is not helpful. For example, the C++ source code function names contain the return type, which would determine the sort order rather than the function names.

Note that the mangled names might contain a dollar sign (\$) character. This does not necessarily indicate an OpenVMS reserved name.

- ❷ The table only contains global symbol definitions from the object modules included in the link. However, there might be more names than expected; the compiler may generate some names (for example, when implementing C++ templates). In the map extract, "descending(int&, int&)", "void myswap <int>(int&, int&)" and "ascending(int&, int&)" are the user-defined template functions from the example Example 2.3. Other names are C++ generated names.

Chapter 6. Understanding Symbol Resolution (Alpha and VAX)

This chapter describes how the linker performs symbol resolution on OpenVMS Alpha and OpenVMS VAX systems.

For information on performing symbol resolution on OpenVMS x86-64 and OpenVMS I64 systems, see Chapter 2.

As one of its primary tasks, the linker must resolve symbolic references between modules. This chapter describes how you can control the process to ensure that the linker resolves symbolic references as you intend.

6.1. Overview

Programs are typically made up of many interdependent modules. For example, one module may define a symbol to represent a program location or data element that is referenced by many other modules. The linker is responsible for finding the correct definition of each symbol referenced in all the modules included in the link operation. This process of matching symbolic references with their definitions is called **symbol resolution**.

6.1.1. Types of Symbols

Symbols can be categorized by their scope, that is, the range of modules over which they are intended to be visible. Some symbols, called **local symbols**, are meant to be visible only within a single module. Because the definition and the references to these symbols must be confined to a single module, language processors such as compilers can resolve these references.

Other symbols, called **global symbols**, are meant to be visible to external modules. A module can reference a global symbol that is defined in another module. Because the value of the symbol is not available to the compiler processing the source file, it cannot resolve the symbolic reference. Instead, a compiler creates a global symbol directory (GSD) in an object module that lists all of the global symbol references and global symbol definitions it contains.

In shareable images, symbols that are intended to be visible to external modules are called **universal symbols**. A universal symbol in a shareable image is the equivalent of a global symbol in an object module. Note, however, that only those global symbols that have been declared as universal are listed in the global symbol table (GST) of the shareable image and are available to external modules to link against.

Language processors determine whether a symbol is local or global. For example, in VAX FORTRAN, statement numbers are local symbols and module entry points are global symbols. In other languages, you can explicitly specify whether a symbol is local or global by including or excluding particular attributes in the symbol definition. Note also that some languages allow you to specify symbols as **weak** or **strong** (see Section 6.5 for more information).

You must explicitly declare universal symbols as part of the link operation in which the shareable image is created. For more information about declaring universal symbols, see Chapter 8.

Note

In some VSI programming languages, certain types of global symbols, such as external variables in C and COMMON data in FORTRAN, are not listed in the GSD as global symbol references or definitions. Because these data types implement virtual memory that is shared, the languages implement them as program sections that are overlaid. These symbols appear as program section definitions in the GSD, not as a symbol definition or reference. (Compilers use program sections to define the memory requirements of an object module). The linker does not include program section definitions in its symbol resolution processing. For information about how the linker processes program sections, see Chapter 7.

On VAX systems, the VAX C language extensions `globalref` and `globaldef` allow you to create external variables that appear as symbol references and definitions in the GSD. For more information, see the VAX C documentation.

On Alpha systems, the VSI C compiler supports the `globalref` and `global deflanguage` extensions. In addition, VSI C supports command line qualifiers and source code pragma statements that allow you to control whether it implements external variables as program sections or as global symbol references and definitions. For more information, see the VSI C documentation.

6.1.2. Linker Symbol Resolution Processing

During its first pass through the input files specified in the link operation, the linker attempts to find the definition for every symbol referenced in the input files. By default, the linker processes all the global symbols defined and referenced in the GSD of each object module and all the universal symbols defined and referenced in the GST of each shareable image. The definition of the symbol provides the value of the symbol. The linker substitutes this value for each instance where the symbol is referenced in the image.

The value of a symbol depends on what the symbol represents. A symbol can represent a routine entry point or a data location within an image. For these symbols, the value of the symbol is an address. A symbol can also represent a data constant (for example, $X = 10$). In this case, the value of the symbol is its actual value (in the example, the value of X is 10).

For symbols that represent addresses in object modules, the value is expressed initially as an offset into a program section. This is how language processors express addresses. Later in its processing, when the linker combines the program sections contributed by all the object modules into the image sections that define the virtual memory layout of the image, it determines the actual value of the address. For information about how the linker determines the virtual memory layout of an image, see Chapter 7.

For symbols that represent addresses in a shareable image, the value of the symbol at link time is architecture specific.

For Alpha images, at link time, the value of a symbol in a shareable image (as listed in the GST of the image) is the offset of the symbol's entry in the symbol vector of the image. A symbol vector entry is a pair of quadwords that contain information about the symbol. The contents of these quadwords depend on whether the symbol represents a procedure entry point, data location, or a constant. Figure 6.1 illustrates the contents of a symbol vector entry for each of these three types of symbols. Note that, at link time, a symbol vector entry for a procedure entry point or a data location is expressed as an offset into the image. At image activation time, when the image is loaded into memory and the base address of the image is known, the image activator converts the image offset

into a virtual address. Figure 6.1 shows the contents of the symbol vector at link time and at image activation time.

Figure 6.1. Symbol Vector Contents

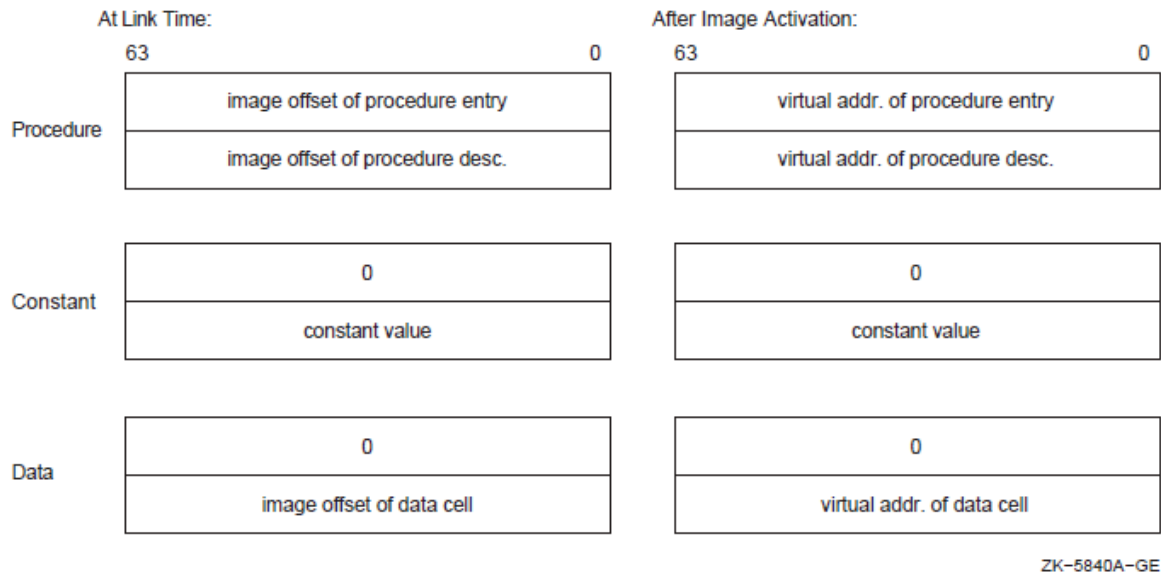

Note that the linker does not allow programs to make procedure calls to symbols that represent data locations.

For VAX images, at link time, the value of a symbol in a shareable image (as listed in the GST of the image) is the offset into the image of the routine or data location, if the symbol was declared universal using the UNIVERSAL=option. If the symbol was declared universal using a transfer vector, the value of the symbol is the offset into the image of the transfer vector entry. If the symbol represents a constant, the GST contains the actual value of the constant.

The actual value of an address symbol in a shareable image is determined *at run-time* by the image activator when it loads the shareable image into memory. The image activator **relocates** all the address references within a shareable image when it loads the image into memory. Once it has determined the absolute values of these addresses, the image activator **fixes up** references to these addresses in the image that linked against the shareable image. Previously, the linker created **fix-ups** that flag to the image activator where it must insert the actual addresses to complete the linkage of a symbolic reference to its definition in an image. The linker listed these fix-ups in the **fix-up section** it creates for the image. For more information about shareable images, see Chapter 8.

For VAX images, you can specify the address at which you want a shareable image loaded into memory by using the BASE= option. When you specify this option, the linker can calculate the absolute addresses of symbols within the shareable image because the base address of the shareable image is known. By specifying a base address, you eliminate the need for the image activator to perform fix-ups and relocations.

Note, however, that basing a shareable image can potentially destroy upward compatibility between the shareable image and other images that were linked against it.

Figure 6.2 illustrates the interdependencies created by symbolic references among the modules that make up an application. In the figure, arrows point from a symbol reference to a symbol definition. (The statements do not reflect a specific programming language.)

Figure 6.2. Symbol Resolution

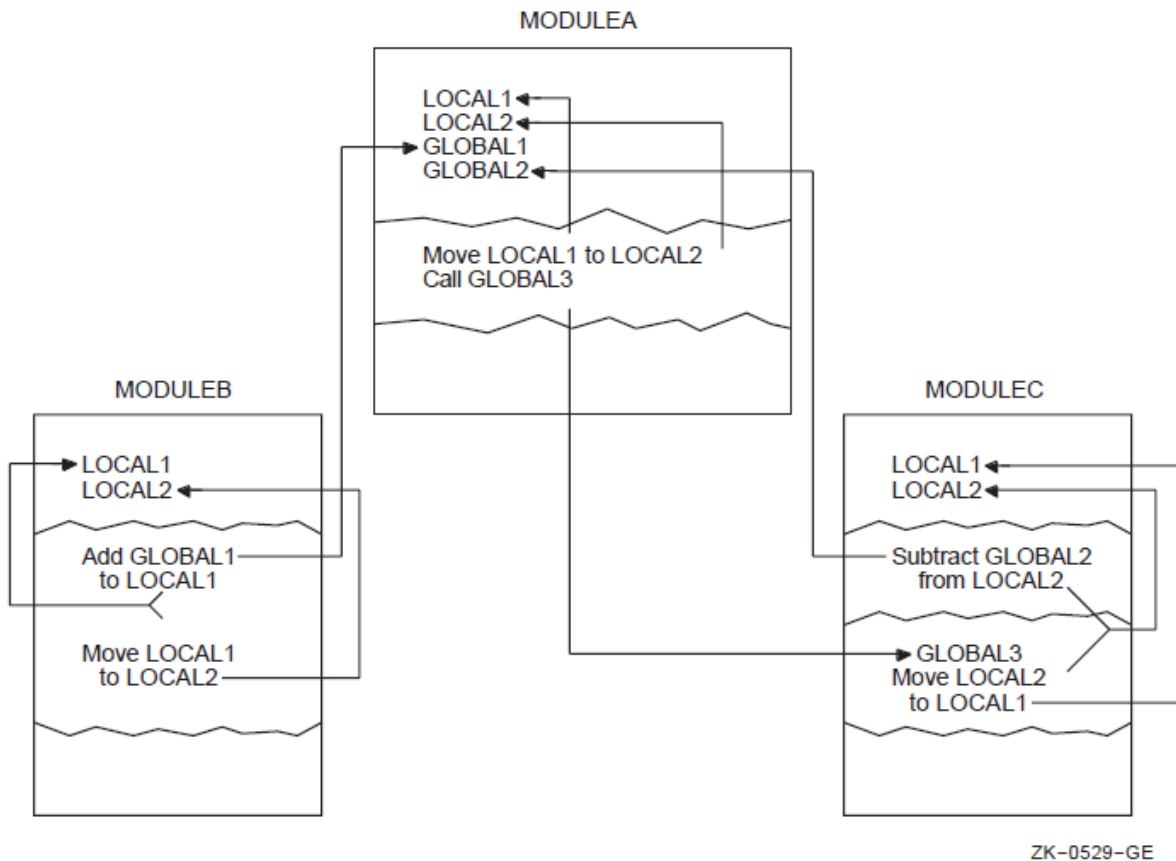

The linker creates an image even if it cannot find a definition for every symbol referenced in the input files it processes. The linker reports these undefined symbols as in the following example, if at least one of these unresolved references is a strong reference. (For information about strong and weak symbolic references, see Section 6.5). The linker includes the message in the map file, if a map file was requested.

```
$ link my_main ! The module MY_MATH is omitted
%LINK-W-NUDFSyms, 1 undefined symbols:
❶ %LINK-I-UDFSYM,          MYSUB
❷ %LINK-W-USEUNDEF, undefined symbol MYSUB referenced
    in psect $CODE offset %X0000001A
    in module MY_MAIN file WORK:[PROGRAMS]MY_MAIN.OBJ;1
```

- ❶ The linker issues an informational message for each symbol for which it cannot find a definition.
- ❷ The linker issues a warning message for each instance where an undefined symbol is referenced in the image.

If you run an image that contains undefined symbols and the symbols are never accessed, the program will run successfully. If you run an image that contains undefined symbols and the image accesses the symbols at run-time, the image will abort, in most cases, with an access violation because the linker assigns the value zero to undefined symbols, as in the following example:

```
$ run my_main
%SYSTEM-F-ACCVIO, access violation, reason mask=00, virtual address=00000000,
PC=00001018, PSL=03C00000
%TRACE-F-TRACEBACK, symbolic stack dump follows
module name      routine name      line   rel PC   abs PC
MY_MAIN          main              15    00000018 00001018
```

6.2. Input File Processing for Symbol Resolution

The linker can include object modules, shareable images, and libraries in its symbol resolution processing. For VAX images, the linker can also include a symbol table file in its symbol resolution processing. (Options files, in which linker options and input files are specified, are not included in symbol resolution).

By default, when the linker processes an object module or shareable image, it includes all the symbol definitions from the object module or shareable image in its processing. However, if you append the `/SELECTIVE_SEARCH` qualifier to the object module or shareable image file specification, the linker includes in its processing only those symbols from the object module or shareable image that define symbols referenced in a previously processed input file. For more information about selectively processing input files, see Section 6.2.4.

Table 6.1 summarizes how the linker processes these different types of input files when performing symbol resolution. The following sections provide more detail on the linker's processing of each type of input file.

Table 6.1. Linker Input File Processing

Input File	How Processed
Object file (.OBJ)	By default, the linker processes all the symbol definitions and references listed in the GSD of the module. If you append the <code>/SELECTIVE_SEARCH</code> qualifier to the input file specification, the linker includes in its processing only those symbol definitions from the GSD that resolve symbolic references found in previously processed input files.
Shareable image file (.EXE)	By default, the linker processes all symbol definitions and references listed in the GST of the image. Note, however, to avoid cluttering the map file of the resultant image, the linker lists only those symbol definitions in the map file that are referenced by other modules. If you append the <code>/SELECTIVE_SEARCH</code> qualifier to the input file specification, the linker includes in its processing only those symbol definitions from the GST that resolve symbolic references found in previously processed input files.
Symbol table file (.STB) ¹	By default, the linker processes all the symbol definitions and references in the GSD of the module. If you append the <code>/SELECTIVE_SEARCH</code> qualifier to the input file specification, the linker includes in its processing only those symbol definitions from the module that resolve symbolic references found in previously processed input files.
Library files (.OLB)	The linker searches the name table of the library for symbols that are undefined in previously processed input files. (A library file's name table lists all the symbols available in all of the modules it contains). If the linker finds the definition of a symbol referenced by a previously processed input file, it includes in the link operation the module in the library that contains the definition of the symbol. Once the object module or shareable image is included in the link operation, the linker processes it as any other object module or shareable image.

Input File	How Processed
	<p>If you append the <code>/INCLUDE</code> qualifier to a library file specification, the linker does <i>not</i> search the library's name table to find undefined symbolic references. Instead, the linker simply includes the specified object module or shareable image specified as a parameter to the <code>/INCLUDE</code> qualifier.</p> <p>You cannot process a library file selectively. However, if the Librarian utility's <code>/SELECTIVE_SEARCH</code> qualifier was specified when the object module or shareable image was inserted into the library, the linker will process the module selectively when it extracts it from the library.</p>

¹VAX specific

6.2.1. Processing Object Modules

The way the linker processes object modules to resolve symbolic references illustrates how the linker processes most other input files. (Symbol table files are object modules. The GST of a shareable image, which the linker processes in symbol resolution, is also created as an object module appended to the shareable image).

For example, the program in Example 6.1 references the symbol `mysub`.

Example 6.1. Module Containing a Symbolic Reference: `my_main.c`

```
#include <stdio.h>
int mysub();
main()
{
    int num1, num2, result;
    num1 = 5;
    num2 = 6;
    result = 0;
    result = mysub( num1, num2 );
    printf("Result is: %d\n", result);
}
```

`mysub`, which Example 6.1 references, is defined in the program in Example 6.2.

Example 6.2. Module Containing a Symbol Definition: `my_math.c`

```
int myadd(int value_1,int value_2) {
    int result;
    result = value_1 + value_2;
    return( result);
}
int mysub(int value_1,int value_2)
    int result;
    result = value_1 - value_2;
    return( result);
}
int mymul(int value_1,int value_2)
    int result;
    result = value_1 * value_2;
    return( result);
}
int mydiv(int value_1,int value_2)
    int result;
    result = value_1 / value_2;
    return( result);
}
```

The GSD created by the language processor for the object module MY_MAIN.OBJ lists the *reference* to the symbol `mysub`. Because object modules cannot be examined using a text editor, the following representation of the GSD is taken from the output of the ANALYZE/OBJECT utility. The example is from the analysis of an OpenVMS Alpha object module. Differences between the format of the symbol reference between VAX object files and Alpha object files are highlighted in the list following the example.

```

4. GLOBAL SYMBOL DIRECTORY (EOBJ$C_GSD) ❶, 344 bytes
.
.
.
9) Global Symbol Specification (EGSD$C_SYM) ❷
  data type: DSC$K_DTYPE_Z (0)
  symbol flags:
    (0) EGSY$V_WEAK      0
    (1) EGSY$V_DEF      0
    (2) EGSY$V_UNI      0
    (3) EGSY$V_REL      0
    (4) EGSY$V_COMM     0
    (5) EGSY$V_VECEP    0 ❸
    (6) EGSY$V_NORM     0 ❹
  symbol: "MYSUB"

```

- ❶ For VAX object files, the symbol for the global symbol directory is OBJ\$C_GSD.
- ❷ For VAX object files, the symbol for a global symbol specification is GSD\$C_SYM.
- ❸ For VAX object files, this field is not included.
- ❹ For VAX object files, this field is not included. For Alpha object files, the value of this field is always zero for symbolic *references*.

The GSD created by the language processor for the object module MY_MATH.OBJ contains the *definition* of the symbol `mysub`, as well as the other symbols defined in the module. The definition of the symbol includes the value of the symbol.

The following excerpt from an analysis of the OpenVMS Alpha object module (performed using the ANALYZE/OBJECT utility) shows the format of a GSD symbol definition entry. Note that, in an OpenVMS Alpha object module, a symbol definition is listed as a Global Symbol Specification.

```

4. GLOBAL SYMBOL DIRECTORY (EOBJ$C_GSD), 46 bytes
.
.
.
9) Global Symbol Specification (EGSD$C_SYM)
  data type: DSC$K_DTYPE_Z (0)
  symbol flags:
    (0) EGSY$V_WEAK      0
    (1) EGSY$V_DEF      1
    (2) EGSY$V_UNI      0
    (3) EGSY$V_REL      1
    (4) EGSY$V_COMM     0
    (5) EGSY$V_VECEP    0
    (6) EGSY$V_NORM     1 ❶
  ❷ psect: 3
  ❸ value: 64 (%X'00000040')
  ❹ code address psect: 5
  ❺ code address: 8 (%X'00000008')
  symbol: "MYSUB"
.
.
.

```

- ❶ The value of the EGSY\$V_NORM flag is 1 if the symbol represents a procedure. The value is set to zero if the symbol represents data.
- ❷ The index of the program section that contains the procedure descriptor for `mysub`.

- ③ The location of the procedure descriptor expressed as the offset from the starting address of the program section that contains the procedure descriptor.
- ④ Index of program section that contains the code entry point.
- ⑤ The location of the code entry point, expressed as the offset from the starting address of the program section that contains the entry point.

The following excerpt from an analysis of the OpenVMS VAX object module (performed using the ANALYZE/OBJECT utility) shows the format of a GSD symbol definition entry. Note that, on VAX systems, a symbol definition is listed as an Entry Point Symbol and Mask Definition record.

```
4. GLOBAL SYMBOL DIRECTORY (OBJ$C_GSD), 46 bytes
.
.
.
2) Entry Point Symbol and Mask Definition (GSD$C_EPM)
   data type: DSC$K_DTYPE_Z (0)
   symbol flags:
       (0) GSY$V_WEAK      0
       (1) GSY$V_DEF      1
       (2) GSY$V_UNI      0
       (3) GSY$V_REL      1
       (4) GSY$V_COMM     0
   psect: 0
   value: 0 (%X'0000000C')
   entry mask: <>
   symbol: "MYSUB"
.
.
.
```

The value of the symbol is expressed as an offset into a program section.

When you link the modules shown in Example 6.1 and Example 6.2 together to create an image, you specify both object modules on the command line, as in the following example:

```
$ LINK MY_MAIN, MY_MATH
```

When the linker processes these object modules, it reads the contents of the GSDs, obtaining the value of the symbol from the symbol definition.

Note that, for Alpha images, in the map file associated with the image, the value of the symbol `mysub` is the location within the image of the procedure descriptor for the routine. The procedure descriptor contains the address of the routine within the image.

For VAX images, the value of the symbol `mysub` is represented in the map file as the location of the entry point mask.

6.2.2. Processing Shareable Images

When the linker processes a shareable image specified as input in a link operation, it processes all the symbol definitions and references in the GST of the image. The GST contains all the universal symbols defined in the shareable image. Because the linker creates the GST of a shareable image in the format of an object module, the processing of shareable images for symbol resolution is similar to the processing of object modules. Note that the linker includes in the map file only those symbols that resolve references to avoid cluttering the listing with extraneous symbols.

For example, the program in Example 6.2 (in Section 6.2.1) can be implemented as a shareable image. (For information about creating a shareable image, see Chapter 8). The shareable image can be included in the link operation as in the following example:

```
$ LINK/MAP/FULL MY_MAIN, SYS$INPUT/OPT
MY_MATH/SHAREABLE
```

The GST created by the linker for the shareable image MY_MATH.EXE contains the *definition* of the symbol `mysub`, as well as the other symbols defined in the module.

Because images cannot be examined using a text editor, the following representations of the GST are taken from the output of the ANALYZE/IMAGE utility.

For Alpha images, the universal symbol `mysub` in the shareable image MY_MATH.EXE appears in the GST of the image as a Universal Symbol Specification record, as illustrated in the following example:

```
SHAREABLE IMAGE - GLOBAL SYMBOL TABLE
.
.
.
4. GLOBAL SYMBOL DIRECTORY (EOBJ$C_EGSD), 200 bytes
.
.
.
3) Universal Symbol Specification (EGSD$C_SYMG)
   data type: DSC$K_DTYPE_Z (0)
   symbol flags:
       (0) EGSY$V_WEAK      0
       (1) EGSY$V_DEF       1
       (2) EGSY$V_UNI       1
       (3) EGSY$V_REL       1
       (4) EGSY$V_COMM      0
       (5) EGSY$V_VECEP     0
       (6) EGSY$V_NORM      1
   psect: 0
   value: 16 (%X'00000010')
   symbol vector entry (procedure)
       %X'00000000 00010008'
       %X'00000000 00000040'
   symbol: "MYSUB"
.
.
.
```

Note that the value of the symbol, as it appears in the Universal Symbol Specification, is the location of the symbol's entry in the image's symbol vector, expressed as an offset from the base of the symbol vector. The symbol vector entry contains the address of `mysub`'s entry point and the address of its procedure descriptor. These locations are expressed as offsets from the base of the image. The entry for a symbol in the GST of an image is a duplicate of the symbol's entry in the symbol vector.

For VAX images, the universal symbol `mysub` in the shareable image MY_MATH.EXE appears in the GST of the image as an Entry Point Symbol and Mask Definition record, as illustrated in the following example:

```
SHAREABLE IMAGE - GLOBAL SYMBOL TABLE
.
.
.
2) Entry Point Symbol and Mask Definition (GSD$C_EPM)
   data type: DSC$K_DTYPE_Z (0)
   symbol flags:
       (0) GSY$V_WEAK      0
       (1) GSY$V_DEF       1
       (2) GSY$V_UNI       1
       (3) GSY$V_REL       1
       (4) GSY$V_COMM      0
   psect: 0
   value: 8 (%X'00000008')
   entry mask: <>
   symbol: "MYSUB"
.
.
.
```

Note that the flag GSY\$V_UNI is set for universal symbols to distinguish them from global symbols in object modules that use the same record format.

Implicit Processing of Shareable Images

For VAX linking, when you specify a shareable image in a link operation, the linker not only processes the shareable image you specify, but also all the shareable images that the shareable image has been linked against. (A shareable image contains a global image section descriptor [GISD] for each shareable image to which it has been linked).

For Alpha linking, the linker does not process the shareable images that the shareable image you specify has been linked against. (Shareable images on Alpha systems still contain GISDs for each shareable image that they have been linked against, however). If your application's build procedure depends on implicit processing of shareable images, you may need to add these shareable images to your linker options file.

6.2.3. Processing Library Files

Libraries specified as input files in link operations contain either object modules or shareable images. The way in which the linker processes library files depends on how you specify the library in the link operation. Sections 6.2.3.1, 6.2.3.2, and 6.2.3.3 describe these differences. Note, however, that once an object module or shareable image is included from the library into the link operation, the linker processes the file as it would any other object module or shareable image.

For example, to create a library and insert the object module version of the program in Example 6.2 into the library, you could specify the following command:

```
$ LIBRARY/CREATE/INSERT MYMATH_LIB MY_MATH
```

The librarian includes the module in its module list and all of the global symbols defined in the module in its name table. To view the library's module list and name table, specify the LIBRARY command with the /LIST and /NAMES qualifiers, as in the following example:

```
$ LIBRARY/LIST/NAMES MYMATH_LIB
Directory of OBJECT library WORK:[PROGS]MYMATH_LIB.OLB:1 on 3-NOV-2000 11:11:33
Creation date: 3-NOV-2000 11:08:04 Creator: VAX-11 Librarian V04-00
Revision date: 3-NOV-2000 11:08:04 Library format: 3.0
Number of modules: 1 Max. key length: 31
Other entries: 5 Preallocated index blocks: 49
Recoverable deleted blocks: 0 Total index blocks used: 2
Max. Number history records: 20 Library history records: 0
Module MY_MATH
MYADD MYDIV
MYMUL MYSUB
```

You can specify the library in the link operation using the following command:

```
$ LINK/MAP/FULL MY_MATH, MYMATH_LIB/LIBRARY
```

The map file produced by the link operation verifies that the object module MY_MATH.OBJ was included in the link operation.

6.2.3.1. Identifying Library Files Using the /LIBRARY Qualifier

When the linker processes a library file identified by the /LIBRARY qualifier, the linker processes the library's name table, looking for the definitions of symbols referenced in previously processed input files.

Note that, to resolve a reference to a symbol defined in a library, the linker must process the module that references the symbol *before* processing the library file. Thus, while the ordering of object

modules and shareable images is not usually important in a link operation, the ordering of library files can be important. For more information about controlling the order in which the linker processes input files, see Section 6.3.

Once the object module or shareable image is included from the library into the link operation, the linker processes all the symbol definitions and references in the module. If you want the linker to selectively process object modules or shareable images that are included in the link operation from a library, you must append the Librarian utility's `/SELECTIVE_SEARCH` qualifier to the file specification of the object module or shareable image when you insert it into the library. Appending the linker's `/SELECTIVE_SEARCH` qualifier to a library file specification in a link operation is illegal. For more information about processing input files selectively, see Section 6.2.4.

Processing Object Module Libraries

When the linker finds a symbol in the name table of an object module library, it extracts from the library the object module that contains the definition and includes it in the link operation. The linker then processes the GSD of the object module extracted from the library, adding an entry to the linker's list of symbol definitions for every symbol defined in the object module, and adding entries to the linker's undefined symbol list for all the symbols referenced by the module (as described in Section 6.2.1). The linker continues to process the undefined symbol list until there are no definitions in the library for any outstanding references. When the linker finishes processing the library, it has extracted all the modules that resolve references generated by modules previously extracted from the library.

Processing Shareable Image Libraries

When the linker finds a symbol in the name table of a shareable image library, it notes which shareable image contains the symbol and then looks for the shareable image to include it in the link operation. By default, the linker looks for the shareable image in the same device and directory as the library file.

For VAX linking, if the linker cannot find the shareable image in the device and directory of the library file, the linker looks for the shareable image in the directory pointed to by the logical name `SYSS$LIBRARY`.

For Alpha linking, if the linker cannot find the shareable image in the device and directory of the library file, the linker looks for the shareable image in the directory pointed to by the logical name `ALPHA$LIBRARY`.

Once it locates the shareable image, the linker processes the shareable image as it does any other shareable image (as described in Section 6.2.2).

6.2.3.2. Including Specific Modules from a Library Using the `/INCLUDE` Qualifier

If the library file is specified with the `/INCLUDE` qualifier, the linker does *not* process the library's name table. Instead, the linker includes in the link operation the modules from the library specified in the `/INCLUDE` qualifier and processes them as it would any other object module or shareable image.

If you append both the `/LIBRARY` qualifier and the `/INCLUDE` qualifier to a library file specification, the linker processes the library's name table to search for modules that contain needed definitions. When the linker finds an object module or shareable image in the library that contains a needed definition, it processes it as described in Section 6.2.3.1. In addition, the linker also includes the modules specified with the `/INCLUDE` qualifier in the link operation and processes them as it would any other object module or shareable image.

6.2.3.3. Processing Default Libraries

In addition to the libraries you specify using the `/LIBRARY` qualifier or the `/INCLUDE` qualifier, the linker also processes certain other libraries by default. The linker processes these default libraries in the following order:

1. **Default user library files.** You specify a default user library by associating the library with one of the linker's default logical names from the range `LNK$LIBRARY`, `LNK$LIBRARY_1`, ... `LNK$LIBRARY_999`. If the `/NOUSERLIBRARY` qualifier is specified, the linker skips processing default user libraries. For more information about defining a default user library, see the description of the `/USERLIBRARY` qualifier in Chapter 10.

If the default user library contains shareable images, the linker looks for the shareable image as described in Section 6.2.3.1.

2. **Default system shareable image library file.** The linker processes the default system shareable image library `IMAGELIB.OLB` by default unless you specify the `/NOSYSSHR` or the `/NOSYSLIB` qualifier.

Note that when the linker needs to include a shareable image from `IMAGELIB.OLB` in a link operation, it always looks for the shareable images in `SYSS$LIBRARY` for VAX linking or `ALPHA$LIBRARY` for Alpha linking. The linker does *not* look for the shareable image in the device and directory of `IMAGELIB.OLB` as it does for other shareable image libraries.

3. **Default system object module library file.** The linker processes the default system object library `STARLET.OLB` by default unless you specify the `/NOSYSLIB` qualifier.

For Alpha linking, when the linker processes `STARLET.OLB` by default, it also processes the shareable image (`SYSS$PUBLIC_VECTORS.EXE`). This shareable image is needed to resolve references to system services. (For VAX linking, references to system services are resolved by linking against the file `SYSS$P1_VECTOR`, which resides in `STARLET.OLB`).

When `STARLET` is not processed by default (for example, when the `/NOSYSLIB` qualifier is specified), the linker does not process `SYSS$PUBLIC_VECTORS.EXE` automatically, even if you explicitly specify `STARLET.OLB` in an options file.

If you specify `SYSS$PUBLIC_VECTORS.EXE` explicitly in an options file when it is already being processed by default, the linker displays the following warning:

```
%LINK-W-MULCLUOPT, cluster SYSS$PUBLIC_VECTORS multiply defined
in options file [filename]
```

6.2.3.4. Open Systems Library Support

If you are developing portable applications using the Network Application Support (NAS) products, a second image library, similar to `IMAGELIB`, is used. The second image library contains components that conform to NAS conventions rather than to OpenVMS conventions. By default, the linker will not search this library because it may contain symbols that do not conform to the OpenVMS global symbol naming rules.

If you want the linker to include the open image library in its processing, define the logical name `LNK$OPEN_LIB` with any non null string value. If the `LNK$OPEN_LIB` logical is defined at link time, the linker searches `OPEN_LIB` in the same way it searches `IMAGELIB`. The open image library search is in addition to any other searches, and it is done after user libraries are searched and before other system libraries are searched, as follows:

1. User libraries, if defined with LNK\$LIBRARY_ *nnn*
2. OPEN_LIB, if LNK\$OPEN_LIB logical is defined
3. IMAGELIB, unless /NOSYSSHR is specified
4. STARLET, unless /NOSYSLIB is specified

6.2.4. Processing Input Files Selectively

By default, the linker processes all the symbol definitions and references in an object module or a shareable image specified as input in a link operation. However, if you append the /SELECTIVE_SEARCH qualifier to an input file specification, the linker processes from the input file only those symbol definitions that resolve references in previously processed input files.

Processing input files selectively can reduce the amount of time a link operation takes and can conserve the linker's use of virtual memory. Note, however, that selective processing can also introduce dependencies on the ordering of input files in the LINK command.

Note

Processing files selectively does not affect the size of the resultant image; the entire object module is included in the image even if only a subset of the symbols it defines is referenced. (Shareable images do not contribute to the size of an image).

For example, in the link operation in Section 6.2.2, the linker processes the shareable image MY_MATH.EXE before it processes the object module MY_MAIN.OBJ because of the way in which the linker clusters input files. (For information about how the linker clusters input files, see Section 6.3.2.1). When it processes the shareable image, the linker includes on its list of symbol definitions all the symbols defined in the shareable image. When it processes the object module MY_MAIN.OBJ and encounters the reference to the symbol `mysub`, the linker has the definition to resolve the reference.

If you append the /SELECTIVE_SEARCH qualifier to the shareable image file specification and all of the other input files are specified on the command line, the link will fail. In the following example, because the linker has no symbols on its undefined symbol list when it processes the shareable image file MY_MATH.EXE, it does not include any symbol definitions from the shareable image in its processing. When it subsequently processes the object module MY_MAIN.OBJ that references the symbol `mysub`, the linker cannot resolve the reference to the symbol. For information about how to correct this link operation, see Section 6.3.2.1.

```
$ LINK MY_MAIN, SYS$INPUT/OPT
MY_MATH/SHAREABLE/SELECTIVE_SEARCH
Ctrl/Z
%LINK-W-NUDFSYMS, 1 undefined symbol:
%LINK-I-UDFSYM,      MYSUB
%LINK-W-USEUNDEF, undefined symbol MYADD referenced
      in psect $CODE offset %X00000011
      in module MY_MAIN file WORK:[PROGRAMS]MY_MAIN.OBJ;6
```

To process object modules or shareable images in a library selectively, you must specify the /SELECTIVE_SEARCH qualifier when you insert the module in the library. The following example creates the library MYMATH_LIB.OLB and inserts the file MY_MATH.OBJ into the library. For more information about using the Librarian utility, see the *VSI OpenVMS Command Definition, Librarian, and Message Utilities Manual*.

```
$ LIBRARY/CREATE/INSERT MYMATH_LIB MY_MATH/SELECTIVE_SEARCH
```

6.3. Ensuring Correct Symbol Resolution

For many link operations, the order in which the input files are specified in the LINK command is not important. However, in complex link operations that specify many library files or process input files selectively, to ensure that the linker resolves all the symbolic references among the input files as you intend, you may need to be aware of the order in which the linker processes the input files. To control the order in which the linker processes input files, you must understand how the linker parses the command line.

6.3.1. Understanding Cluster Creation

As it parses the command line, the linker groups the input files you specify into **clusters** and places these clusters on a cluster list. A cluster is an internal linker construct that determines image section creation. The position of an input file in a cluster and the position of that cluster on the linker's cluster list determine the order in which the linker processes the input files you specify.

The linker always creates at least one cluster, called the **default cluster**. The linker may create additional clusters, called **named clusters**, depending on the types of input files you specify and the linker options you specify. If it creates additional clusters, the linker places them on the cluster list ahead of the default cluster, in the order in which it encounters them in the options file. The default cluster appears at the end of the cluster list. (Within the default cluster, input files appear in the same order in which they are specified on the LINK command line).

Clusters for shareable images specified in shareable image libraries appear *after* the default cluster on the cluster list because they are created later in linker processing, when the linker knows which shareable images in the library are needed for the link operation.

The linker groups input files into clusters according to file type. Table 6.2 lists the types of input files accepted by the linker and describes how the linker processes them when creating clusters.

Table 6.2. Linker Input File Cluster Processing

Input File	Cluster Processing
Object file (.OBJ)	Placed in the default cluster unless explicitly placed in a named cluster using the CLUSTER= option.
Shareable image file (.EXE)	Always placed in a named cluster.
Symbol table file (.STB) ¹	Placed in the default cluster unless explicitly placed in a named cluster using the CLUSTER= option.
Library files (.OLB)	<p>Placed in the default cluster unless explicitly placed in a named cluster using the CLUSTER= option. If the library contains shareable images and the linker includes a shareable image from the library in the link operation, the linker creates a new cluster for the shareable image.</p> <p>The linker puts input files included in a link operation from a library using the /INCLUDE qualifier in the same cluster as the library.</p> <p>The linker puts modules extracted from any default user library that is an object library and from STARLET.OLB in the default cluster. However, because they are shareable images, the linker puts modules extracted from IMAGELIB.OLB into new clusters at the end of the cluster list (after the default cluster).</p>

Input File	Cluster Processing
Options file (.OPT)	Not placed in a cluster.

¹VAX specific

The following example illustrates how the linker puts the various types of input files in clusters. To see which clusters the linker creates for this link operation, look at the Image Section Synopsis section of the image map file. Figure 6.3 illustrates the clusters created for this link operation.

```
$ DEFINE LNK$LIBRARY SYS$DISK:[ ]MY_DEFAULT_LIB.OLB
$ LINK MY_MAIN.OBJ, MY_LIB.OLB/LIBRARY, SYS$INPUT/OPT
CLUSTER=MY_CLUS, , MY_PROG.OBJ
MY_SHARE.EXE/SHAREABLE
MY_SHARE_LIB.OLB/LIBRARY
MY_TAB.STB
```

Figure 6.3. Clusters Created for Sample Link

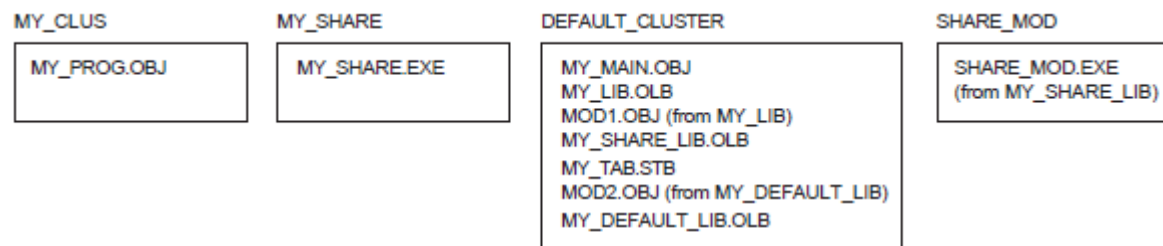

ZK-5291A-GE

The linker processes input files in cluster order: processing each input file starting with the first file in the first cluster, then the second, and so on, until it has processed all files in the first cluster. Then it does the same for the second cluster, and the next, and so on, until it has processed all files in all clusters.

6.3.2. Controlling Cluster Creation

You can control in which cluster the linker places an input file by using either of the following linker options:

- CLUSTER= option
- COLLECT= option

6.3.2.1. Using the CLUSTER= Option to Control Clustering

The CLUSTER= option causes the linker to create a named cluster and to place in the cluster the object modules specified in the option. (The linker puts shareable images in their own clusters by default).

For example, you can use the CLUSTER= option to fix the link operation illustrated in Section 6.2.4, where the link failed because a shareable image was processed selectively. To make the linker process the object module MY_MAIN.OBJ before it processes the shareable image MY_MAIN.EXE, put the object module in a named cluster. In the following example, the /EXECUTABLE qualifier is specified on the command line to specify the name of the resultant image, because MY_MAIN is not specified on the command line.

```
$ link/executable=my_main sys$input/opt
CLUSTER=mymain_clus,,,my_main
my_math/shareable/selective_search
Ctrl/Z
```

The Object Module Synopsis section of the image map file verifies that the linker processed the object module MY_MAIN before it processed the shareable image MY_MATH, as in the following map file excerpt:

```
+-----+
! Object Module Synopsis !
+-----+
Module Name      Ident      Bytes      File
-----
MY_MAIN          V1.0          105 MY_MAIN.OBJ;1
MY_MATH          V1.0           12 MY_MATH.EXE;1
.
.
.
```

6.3.2.2. Using the COLLECT= Option to Control Clustering

You can also create a named cluster by specifying the COLLECT= option. The COLLECT= option directs the linker to put specific program sections in a named cluster. The linker creates the cluster if it does not already exist. Note that the COLLECT= option manipulates program sections, *not* input files.

The linker sets the global (GBL) attribute of the program sections specified in a COLLECT= option to enable a global search for the definition of that program section.

6.4. Resolving Symbols Defined in the OpenVMS Executive

For VAX linking, you link against the OpenVMS executive by specifying the system symbol table (SY\$LIBRARY:SYS.STB) in the link operation. Because a symbol table file is an object module, the linker processes the symbol table file as it would any other object module.

For Alpha linking, you link against the OpenVMS executive by specifying the /SYSEXE qualifier. When this qualifier is specified, the linker selectively processes the system shareable image, SY\$BASE_IMAGE.EXE, located in the directory pointed to by the logical name ALPHA\$LOADABLE_IMAGES. The linker does not process SY\$BASE_IMAGE.EXE by default.

Note that, because the linker is processing a shareable image, references to symbols in the OpenVMS executive are fixed up at image activation, not fully resolved at link time as they are for VAX linking. Also note that the linker looks for SY\$BASE_IMAGE.EXE in the directory pointed to by the logical name ALPHA\$LOADABLE_IMAGES, *not* in the directory pointed to by the logical name SY\$LIBRARY as for VAX linking.

When the /SYSEXE qualifier is specified, the linker processes the file selectively. To disable selective processing, specify the /SYSEXE=NOSELECTIVE qualifier. For more information about using the /SYSEXE qualifier, see the description of the qualifier in Chapter 10.

Relation to Default Library Processing

When you specify the /SYSEXE qualifier, the linker processes the SY\$BASE_IMAGE.EXE file *after* processing the system shareable image library, IMAGELIB.OLB, and *before* processing the system object library, STARLET.OLB. (Note that the linker also processes the system service shareable image, SY\$PUBLIC_VECTORS.EXE, when it processes STARLET.OLB by default).

The `/SYSSHR` and `/SYSLIB` qualifiers, which control processing of the default system libraries, do not affect `SYSS$BASE_IMAGE.EXE` processing. When the `/NOSYSSHR` qualifier is specified with the `/SYSEXE` qualifier, the linker does not process `IMAGELIB.OLB`, but still processes `SYSS$BASE_IMAGE.EXE` and then `STARLET.OLB` and `SYSS$PUBLIC_VECTORS.EXE`. When `/NOSYSLIB` is specified, the linker does not process `IMAGELIB.OLB`, `STARLET.OLB`, or `SYSS$PUBLIC_VECTORS`, but still processes `SYSS$BASE_IMAGE.EXE`.

To process `SYSS$BASE_IMAGE.EXE` before the shareable images in `IMAGELIB.OLB`, specify `SYSS$BASE_IMAGE.EXE` in a linker options file as you would any other shareable image. If you specify `SYSS$BASE_IMAGE.EXE` in your options file, do not use the `/SYSEXE` qualifier.

Figure 6.4 illustrates how the `/SYSEXE` qualifier, in combination with the `/SYSSHR` and `/SYSLIB` qualifiers, can affect linker processing. (The default syntax illustrated in the figure is rarely specified).

Figure 6.4. Linker Processing of Default Libraries and `SYSS$BASE_IMAGE.EXE`

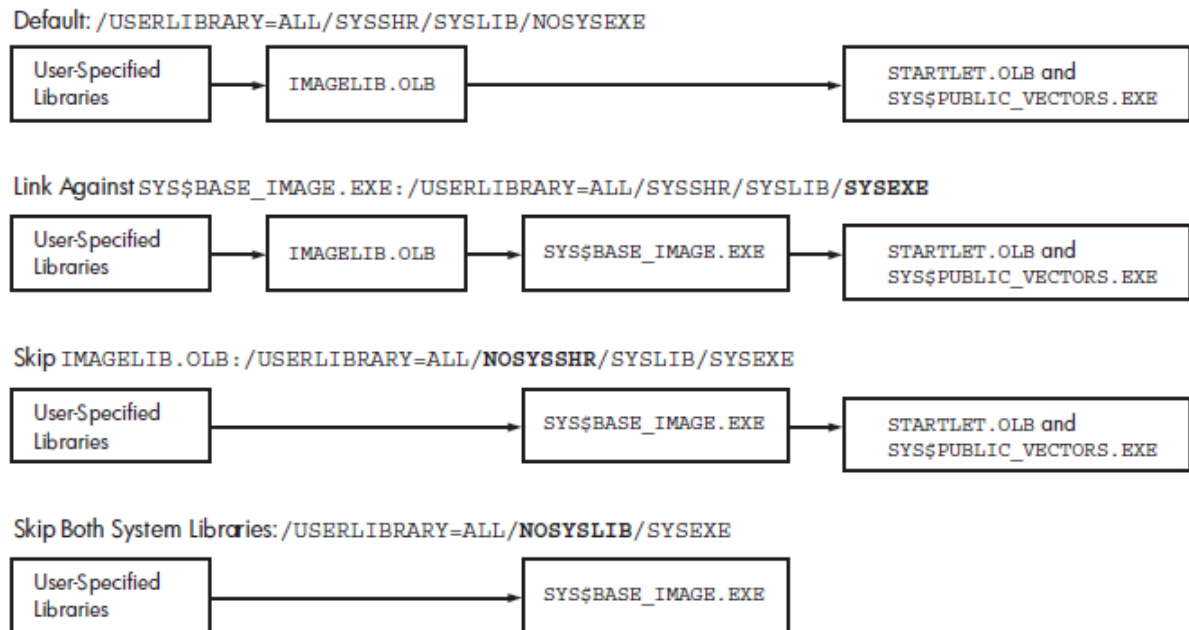

VM-1202A-AI

6.5. Defining Weak and Strong Global Symbols

In the dialects of MACRO, BLISS, and Pascal supported on both VAX and Alpha systems, you can define a global symbol as either strong or weak, and you can make either a strong or a weak reference to a global symbol.

In these languages, all definitions and references are strong by default. To make a weak definition or a weak reference, you must use the `.WEAK` assembler directive (in MACRO), the `WEAK` attribute (in BLISS), or the `WEAK_GLOBAL` or `WEAK_EXTERNAL` attribute (in Pascal).

The linker records each symbol definition and each symbol reference in its global symbol table, noting for each whether it is strong or weak. The linker processes weak references differently from strong references and weakly defined symbols differently from strongly defined symbols.

A strong reference can be made to a weakly defined symbol or to a strongly defined symbol.

For a strong reference, the linker checks all explicitly specified input modules and libraries and all default libraries for a definition of the symbol. In addition, if the linker cannot locate the definition needed to resolve the strong reference, it reports the undefined symbol and assigns the symbol a value, which usually results in a run-time error for accessing the data or calling the routine.

A weak reference can be made to a weakly defined symbol or to a strongly defined symbol. In either case, the linker resolves the weak reference in the same way it does a strong reference, with the following exceptions:

- The linker will not search library modules that have been specified with the `/LIBRARY` qualifier or default libraries (user-defined or system) solely to resolve a weak reference. If, however, the linker resolves a strong reference to another symbol in such a module, it will also use that module to resolve any weak references.
- If the linker cannot locate the definition needed to resolve a weak reference, it assigns the symbol a value of 0, but does not report an error (as it does if the reference is strong). If, however, the linker reports any unresolved strong references, it will also report any unresolved weak references.

One purpose of making a weak reference arises from the need to write and test incomplete programs. The resolution of all symbolic references is crucial to a successful linking operation. Therefore, a problem arises when the definition of a referenced global symbol does not yet exist (as would be the case, for example, if the global symbol definition is an entry point to a module that is not yet written). The solution is to make the reference to the symbol weak, which informs the linker that the resolution of this particular global symbol is not crucial to the link operation.

By default, all global symbols in all VAX and Alpha languages have a strong definition.

A strongly defined symbol in a library module is included in the library symbol table; a weakly defined symbol in a library module is not. As a result, if the module containing the weak symbol definition is in a library but has not been specified for inclusion by means of the `/INCLUDE` qualifier, the linker will not be able to resolve references (strong or weak) to the symbol. If, however, the linker has selected that library module for inclusion (in order to resolve a strong reference), it will be able to resolve references (strong or weak) to the weakly defined symbol.

If the module containing the weak symbol definition is explicitly specified either as an input object file or for extraction from a library (by means of the `/INCLUDE` qualifier), the weak symbol definition is as available for symbol resolution as a strong symbol definition.

Chapter 7. Understanding Image File Creation (Alpha and VAX)

This chapter describes how the linker creates an image on OpenVMS Alpha and OpenVMS VAX systems. The linker creates images from the input files you specify in a link operation. You can control image file creation by using linker qualifiers and options.

7.1. Overview of Creating Images on Alpha/VAX Systems

After the linker has resolved all symbolic references between the input files specified in the LINK command (described in Chapter 6), the linker knows all the object modules and shareable images that are required to create the image. For example, the linker has extracted from libraries specified in the LINK command those modules that contain the definitions of symbols required to resolve symbolic references in other modules. The linker must now combine all these modules into an image.

To create an image, the linker must perform the following processing:

- **Determine the memory requirements of the image.** The memory requirements of an image are the sum of the memory requirements of each object module included in the link operation. The language processors that create the object modules specify the memory requirements of an object module as **program section** definitions. A program section represents an area of memory that has a name, a length, and other characteristics, called **attributes**, which describe the intended or permitted usage of that portion of memory. Section 7.2 describes program sections.

The linker processes the program section definitions in each object module, combining program sections with similar attributes into an **image section**. Each image section specifies the size and attributes of a portion of the virtual memory of an image. The image activator uses the image section attributes to determine the characteristics of the physical memory pages into which it loads the image, such as protection.

Figure 7.1 illustrates how memory requirements are communicated from the language processor to the linker and from the linker to the image activator. Section 7.3 provides more information about this process.

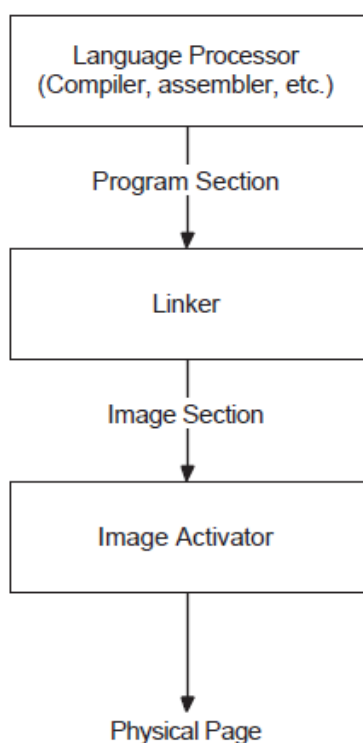
Figure 7.1. Communication of Image Memory Requirements on Alpha/VAX

ZK-5199A-GE

Note that shareable images included in link operations have already been processed by the linker. These images are separate images with their own memory requirements, as specified by their own image sections. The linker does, however, create special global image section descriptors (GISDs) for each shareable image to which an image has been linked. The image activator activates these shareable images at run-time.

- **Initialize the image.** When image sections are first created, they are empty. In this step of linker processing, the linker fills the image sections with the machine code and data, as specified by the Text Information and Relocation (TIR) commands in the object module. Section 7.4 provides more information about this process.

For Alpha linking, the linker also attempts to optimize the performance of an image by replacing Jump to Subroutine (JSR) instruction sequences with the more efficient Branch to Subroutine (BSR) instruction sequences.

After creating image sections and filling them with binary code and data, the linker writes the image to an image file. Section 7.4.1 describes this process. To keep the size of image files manageable, the linker does not allocate space in the image file for image sections that have not been initialized with any data unless this function has been disabled (that is, the linker does not write pages of zeros to the image file). The linker can create **demand-zero** image sections, which the operating system initializes at run-time when a reference to the image section requires the operating system to move the pages into memory. Section 7.4.3 describes how the linker creates demand-zero image sections.

7.2. Creating Program Sections (Alpha/VAX)

Language processors create program sections and define their attributes. The number of program sections created by a language processor and the attributes of these program sections are dependent

upon language semantics. For example, some programming languages implement global variables as separate program sections with a particular set of attributes. Programmers working in high-level languages typically have little direct control over the program sections created by the language processor. Medium- and low-level languages provide programmers with more control over program section creation. For more information about the program section creation features of a particular programming language, please refer to the appropriate OpenVMS programming language documentation.

In general, the linker does not create program sections. However, for Alpha linking, the linker creates a special program section for a shareable image, named \$SYMVECT, which contains the symbol vector of the shareable image.

Program Section Attributes

The language processors define the attributes of the program sections they create and communicate these attributes to the linker in program section definition records in the global symbol directory (GSD) in an object module. (The GSD also contains global symbol definitions and references, as described in Chapter 6).

Program section attributes control various characteristics of the area of memory described by the program section, such as the following:

- **Access.** Using program section attributes, compilers can prohibit some types of access, such as write access. Using other program section attributes, compilers can allow access to the program section by more than one process.
- **Positioning.** By specifying certain program section attributes, compilers can specify to the linker how it should position the program section in memory.

Program section attributes are Boolean values, that is, they are either on or off. Table 7.1 lists all program section attributes with the keyword you can use to set or clear the attribute, using the PSECT_ATTR=option. For more information about using the PSECT_ATTR= option, see Section 7.3.6.

For example, to specify that a program section should have write access, specify the writability attribute as WRT. To turn off an attribute, specify the negative keyword. Some attributes have separate keywords that express the negative of the attribute. For example, to turn off the global attribute (GBL), you must specify the local attribute (LCL). Note that the alignment of a program section is not strictly considered an attribute of the program section. However, because you can set it using the PSECT_ATTR= option, it is included in the table.

Table 7.1. Program Section Attributes (Alpha/VAX)

Attribute	Keyword	Description						
Alignment	—	Specifies the alignment of the program section as an integer that represents the power of 2 required to generate the desired alignment. For certain alignments, the linker supports keywords to express the alignment. The following table lists all the alignments supported by the linker with their keywords:						
		<table border="1"> <thead> <tr> <th>Power of 2</th> <th>Keyword</th> <th>Meaning</th> </tr> </thead> <tbody> <tr> <td>0</td> <td>BYTE</td> <td>Alignment on byte boundaries.</td> </tr> </tbody> </table>	Power of 2	Keyword	Meaning	0	BYTE	Alignment on byte boundaries.
		Power of 2	Keyword	Meaning				
0	BYTE	Alignment on byte boundaries.						

Attribute	Keyword	Description		
		1	WORD	Alignment on word boundaries.
		2	LONG	Alignment on longword boundaries.
		3	QUAD	Alignment on quadword boundaries.
		4	OCTA	Alignment on octaword boundaries.
		9	—	Alignment on 512-byte boundaries.
		13	—	Alignment on 8 KB boundaries.
		14	—	Alignment on 16 KB boundaries.
		15	—	Alignment on 32 KB boundaries.
		16	—	Alignment on 64 KB boundaries.
		—	PAGE	Alignment on the default target page size, which is 64 KB for Alpha linking and 512 bytes for VAX linking. You can override this default by specifying the /BPAGE qualifier.
Position Independence	PIC/NOPIC	Specifies that the program section can run anywhere in virtual address space. Applicable in shareable images only. Note that this attribute is not meaningful for Alpha images, but it is still used to sort program sections.		
Overlaid/Concatenated	OVR/CON	When set to OVR, specifies that the linker may combine (overlay) this program section with other program sections with the same name and attribute settings. Program sections that are overlaid are assigned the same base address. When set to CON, the linker concatenates the program sections.		
Relocatable/Absolute	REL/ABS	When set to REL, specifies that the linker can place the program section anywhere in virtual memory, according to the memory allocation strategy for the type of image being produced. When set to ABS, this attribute specifies that the program section is an absolute program section that contains no binary data or code and appears to be based at virtual address 0. Absolute program sections are used by compilers primarily to define constants.		

Attribute	Keyword	Description
Global/Local	GBL/LCL	When set to GBL, specifies that the linker should gather contributions to the program section <i>from all clusters</i> and place them in the same image section. When set to LCL, the linker gathers program sections into the same image section only if they are in the same cluster. The memory for a global program section is allocated in the cluster that contains the first contributing module.
Shareability	SHR/NOSHR	Specifies that the program section can be shared between several processes. Only used to sort program sections in shareable images.
Executability	EXE/NOEXE	Specifies that the program section contains executable code. If an image transfer address is defined in a nonexecutable program section, the linker issues a diagnostic message.
		¹ For Alpha linking, the EXE attribute is propagated to the image section descriptor where it is used by the Install utility when it is installing the image as a resident image. For information about resident images, see the description of the /SECTION_BINDING qualifier in Chapter 10.
Writability	WRT/NOWRT	Specifies that the contents of a program section can be modified at run-time.
Protected Vectors	VEC/NOVEC	Specifies that the program section contains privileged change-mode vectors or message vectors. In shareable images, image sections with the VEC attribute are automatically protected.
Solitary	SOLITARY	Specifies that the linker should place this program section in its own image section. Useful for programs that map data into specific locations in their virtual memory space. Note that compilers do not set this attribute. You can set this attribute using the PSECT_ATTR=option.
Unmodified ¹	NOMOD/MOD	When set, specifies that the program section has not been initialized (NOMOD). On Alpha systems, the linker uses this attribute to create demand zero sections; see Section 7.4.3. Only compilers can set this attribute. You can clear this attribute only by specifying the MOD keyword in the PSECT_ATTR=option.
COM ¹	—	Used by the VSI C compiler to implement the relaxed symbol reference/definition model for external variables. See the C documentation for more information. This attribute cannot be modified using the PSECT_ATTR= option.
Readability	RD	Reserved to OpenVMS.

Attribute	Keyword	Description
User/Library	USR/LIB	Reserved to OpenVMS. To ensure future compatibility, this attribute should be clear.

¹Alpha specific

To illustrate program section creation, consider the program sections created by the VAX C compiler when it processes the sample programs in the following examples.

Example 7.1. Sample Program MYTEST.C

```
extern int global_data;
int myadd();
int mysub();
main()
{
    int num1, num2, res1, res2;
    static int my_data;
    num1 = 5;
    num2 = 6;
    res1 = myadd( num1, num2 );
    res2 = mysub( num1, num2 );
    printf("res1 = %d, res2 =%d, globaldata=%d\n",
           res1,res2,global_data);
}
```

Example 7.2. Sample Program MYADD.C

```
#include <stdio.h>
myadd(value_1,value_2)
    int value_1;
    int value_2;
{
    int result;
    static int add_data;
    printf("In MYADD.C\n");
    result = value_1 + value_2;
    return( result );
}
```

Example 7.3. Sample Program MYSUB.C

```
int global_data = 5;
mysub(value_1,value_2)
    int value_1;
    int value_2;
{
    int result;
    static int sub_data;
    result = value_1 - value_2;
    return( result );
}
```

To see what program sections the VAX C compiler creates for these programs, use the ANALYZE/OBJECT utility to examine the global symbol directory (GSD) in each object module. (Note that the names the language processors assign to program sections are architecture specific).

Example 7.4 presents an excerpt from the analysis of the object module MYTEST.OBJ. Only the program section definitions are included in the excerpt.

Example 7.4. Program Sections Generated by Example 7.1

```

4. GLOBAL SYMBOL DIRECTORY (OBJ$C_GSD), 138 bytes
.
.
.
6) Program Section Definition (GSD$C_PSC)
  ❶ alignment: 4-byte boundary      <-- psect 0
  ❷ attribute flags:
      (0) GPS$V_PIC      1
      (1) GPS$V_LIB      0
      (2) GPS$V_OVR      0
      (3) GPS$V_REL      1
      (4) GPS$V_GBL      0
      (5) GPS$V_SHR      1
      (6) GPS$V_EXE      1
      (7) GPS$V_RD       1
      (8) GPS$V_WRT      0
      (9) GPS$V_VEC      0
  ❸ allocation: 63 (%X'0000003F')
  ❹ symbol: "$CODE"
7) Program Section Definition (GSD$C_PSC)
  alignment: 4-byte boundary      <-- psect 1
  attribute flags:
      (0) GPS$V_PIC      1
      (1) GPS$V_LIB      0
      (2) GPS$V_OVR      0
      (3) GPS$V_REL      1
      (4) GPS$V_GBL      0
      (5) GPS$V_SHR      0
      (6) GPS$V_EXE      0
      (7) GPS$V_RD       1
      (8) GPS$V_WRT      1
      (9) GPS$V_VEC      0
  allocation: 4 (%X'00000004')
  symbol: "DATA"
8) Program Section Definition (GSD$C_PSC)
  alignment: 4-byte boundary      <-- psect 2
  attribute flags:
      (0) GPS$V_PIC      1
      (1) GPS$V_LIB      0
      (2) GPS$V_OVR      1
      (3) GPS$V_REL      1
      (4) GPS$V_GBL      1
      (5) GPS$V_SHR      1
      (6) GPS$V_EXE      0
      (7) GPS$V_RD       1
      (8) GPS$V_WRT      1
      (9) GPS$V_VEC      0
  allocation: 4 (%X'00000004')
  symbol: "GLOBAL_DATA"
9) Program Section Definition (GSD$C_PSC)
  alignment: 4-byte boundary      <-- psect 3
  attribute flags:
      (0) GPS$V_PIC      1
      (1) GPS$V_LIB      0
      (2) GPS$V_OVR      0
      (3) GPS$V_REL      1
      (4) GPS$V_GBL      0
      (5) GPS$V_SHR      0
      (6) GPS$V_EXE      0
      (7) GPS$V_RD       1
      (8) GPS$V_WRT      1
      (9) GPS$V_VEC      0
  allocation: 36 (%X'00000024')
  symbol: "$CHAR_STRING_CONSTANTS"
.
.
.

```

Note that you can also determine the program sections in an object module *after* a link operation by looking at the Program Section Synopsis section of an image map file, as illustrated in Example 7.7.

- ❶ Alignment specifies the address boundary at which the linker places a module's contribution to the program section.
- ❷ Attribute flags indicate which program section attributes are set. The attributes are listed by their full symbolic name, that is, each abbreviation is preceded by the character string “GPS\$V_”. Note that, for attributes that are turned off by specifying different keywords, only the keyword that sets the attribute is listed. For example, you can see whether the program section is overlaid by checking attribute flag number 2. If the value is 1, the program section is overlaid; if the value is 0, the program section must be concatenated. Table 7.1 lists all the program section attributes. Note that the solitary attribute is not included in the GSD of an object module because that attribute is not set by language processors.

For Alpha linking, the program section display includes several additional attribute flags. The COM attribute is reserved to OpenVMS. The NOMOD attribute indicates that the program section does not contain initialized data. The linker gathers program sections with this attribute into demand-zero image sections. Section 7.4.3 describes how the linker creates demand-zero image sections.

- ❸ Allocation indicates the number of bytes required for the program section.
- ❹ Symbol indicates the name of the program section.

Figure 7.2 illustrates the program sections created by the VAX C compiler for the programs in Examples 7.1, 7.2, and 7.3. (The shaded areas represent the settings of the program section attributes the linker considers when sorting the program sections into image sections in an executable image. See Section 7.3.3 for more information about how the linker creates image sections).

Figure 7.2. Program Sections Created for Examples 7.1, 7.2, and 7.3

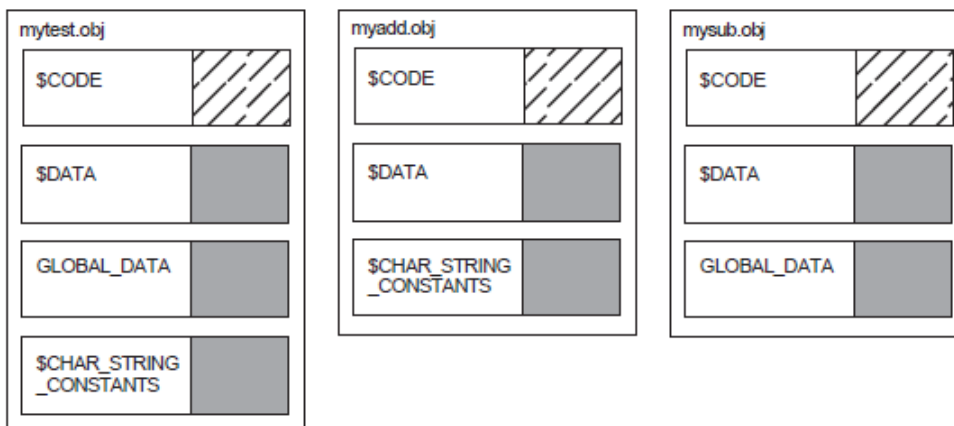

ZK-5200A-AI

7.3. Creating Image Sections

To create the image sections that define the memory requirements and page protection characteristics of an image, the linker processes the program section definitions in the object modules specified in the link operation. The number and type of image sections the linker creates depend on the number of clusters the linker creates when processing the LINK command and on the attributes of the program sections in the object modules in each cluster. Section 7.3.1 describes how the clustering of input files affects image section creation. Section 7.3.2 describes the effects of program section attributes on image section creation.

7.3.1. Processing Clusters to Create Image Sections

To create image sections, the linker processes the program section definitions in the input files you specify in the LINK command. The linker processes these input files on a cluster-by-cluster basis (as described in Section 6.3.1).

In general, only program sections in a particular cluster can contribute to a particular image section. However, the linker crosses cluster boundaries when processing program sections with the global (GBL) attribute. When the linker encounters a program section with the global attribute, it searches all the previously processed clusters for a program section with the same name and attributes and, if it finds one, places the new definition of the global program section in the same cluster as the first definition of the program section.

The linker processes input files in the order in which they appear in the clusters, making two passes through the cluster list.

On its first pass, the linker processes **based** clusters. Based clusters specify the location within memory at which the linker must position them. A based cluster can be a cluster that contains a based shareable image or a cluster, created by the CLUSTER= option, in which a base address was specified.

For VAX linking, you can also use the BASE= option to specify the base address of the default cluster.

For more information about creating based clusters, see the descriptions of the CLUSTER= and BASE= options in Chapter 10.

After processing based clusters, the linker then processes non based clusters. The linker ignores non based (position-independent) shareable image clusters because they are allocated virtual memory at run-time.

A LINK command to create an image using the object modules in Section 7.2 is shown in Example 7.5.

Example 7.5. Linking Examples 7.1, 7.2, and 7.3

```
$ LINK/MAP/FULL MYTEST, MYADD, SYS$INPUT/OPT
CLUSTER=MYSUB_CLUS, ,MYSUB
SYS$LIBRARY:VAXCTRL/SHARE
Ctrl/Z
```

The CLUSTER= option in this LINK command causes the linker to create a cluster named MYSUB_CLUS, which contains the object module MYSUB.OBJ. The linker also creates a cluster for the C Run-Time Library shareable image VAXCTRL.EXE. The linker puts the object modules MYTEST.OBJ and MYADD.OBJ in the default cluster. These clusters appear on the linker's cluster list in the following order:

1. MYSUB_CLUS
2. VAXCTRL
3. DEFAULT_CLUSTER

The linker always processes the default cluster last. (For Alpha linking, you do not need to explicitly include the C Run-Time Library shareable image in the link operation because it resides in the default system shareable image library IMAGELIB.OLB, which the linker processes by default).

7.3.2. Combining Program Sections into Image Sections

The linker creates image sections by grouping together program sections with similar attributes. Within an image section, the linker organizes program sections alphabetically by name. If more than one object module contributes to the same program section, the linker lays out their contributions in the order it processes them.

Figure 7.3 shows how the linker groups the program sections in the object modules from the sample link into image sections, based on the setting of their significant attributes. In the figure, the settings of these significant attributes are represented by shading. (The figure considers attributes that are significant when creating executable images, not shareable images. Section 7.3.3 provides more information about which program section attributes are significant).

Note, in the figure, that the overlaid contributions from `MYSUB.OBJ` and `MYTEST.OBJ` to the program section, `GLOBAL_DATA`, both appear in the `MYSUB_CLUS` cluster, even though the object module `MYTEST.OBJ` is in the default cluster. The linker puts all contributions to a global program section in the cluster in which it is first defined.

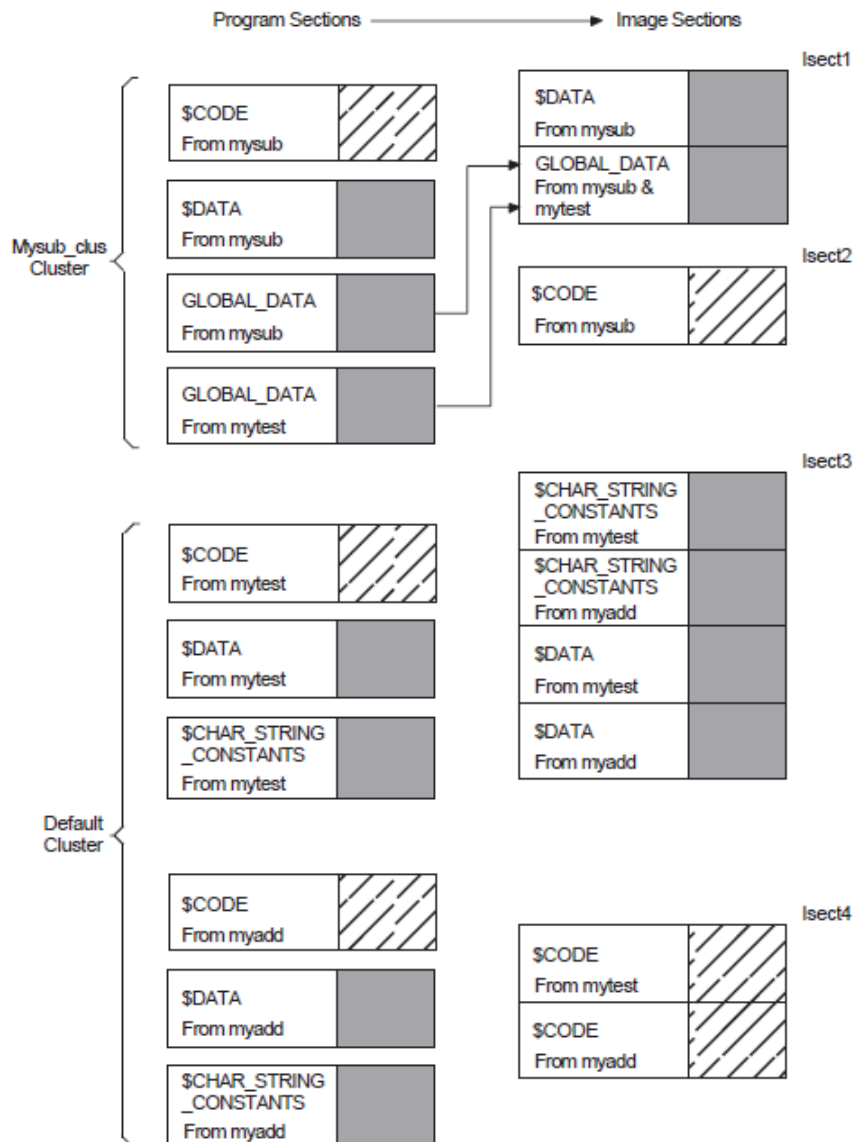
Figure 7.3. Combining Program Sections into Image Sections

ZK-5201A-AI

7.3.3. Processing Significant Program Section Attributes (Alpha/VAX)

When combining program sections into image sections, the linker considers only a subset of program section attributes. The set of significant attributes varies according to the type of image being created. When creating an executable image, the linker considers all combinations of the following attributes when combining program sections into image sections:

- Writability (WRT/NOWRT)
- Executability (EXE/NOEXE)
- Protected vector (VEC/NOVEC)
- Unmodified (NOMOD/MOD) (Alpha linking only)

When creating a shareable image, the linker considers all combinations of the following attributes when combining program sections into image sections:

- Writability (WRT/NOWRT)
- Executability (EXE/NOEXE)
- Shareability (SHR/NOSHR)
- Position independence (PIC/NOPIC)
- Protected vector (VEC/NOVEC)
- Unmodified (NOMOD/MOD) (Alpha linking only)

The linker creates only one large image section for system images, so combining program sections by attributes is not applicable.

Tables 7.2 and 7.3 list all the possible combinations of program section attributes for executable images and shareable images. Note that the order in which the combinations appear in the table (each row) is the same order in which the linker processes them. For example, the linker first processes all program sections with the NOWRT, NOEXE, and NOVEC attributes, creating an image section of program sections with these attributes. The linker then processes all program sections with the WRT, NOEXE, and NOVEC attributes, creating an image section for these program sections. The linker continues this processing until all the combinations of significant attributes have been processed and all the program sections in the cluster have been placed in an image section.

The tables include only program sections that are relocatable (with the REL attribute). Absolute program sections (with the ABS attribute), by definition, can have no allocation (they contain only constants) and cannot contribute to an image section.

For OpenVMS Alpha images, the tables assume that the images are linked using the /DEMAND_ZERO qualifier, which is the default. (When this qualifier is specified, the linker groups program sections that do not contain any data into demand-zero image sections, allocating memory for the image section but not writing zeros to disk). If the image is linked with the /NODEMAND_ZERO qualifier, the linker allocates space for the image section in the image file. Note that the /NODEMAND_ZERO qualifier does not affect how the linker sorts program sections; it proceeds exactly as specified by the table. However, when the image is written, the linker allocates disk space for the image section and fills the space with zeros.

The tables also show how a particular combination of program section attributes determines the attributes of the image section in which it is placed. For more information about image section attributes, see Section 7.3.5.

Table 7.2. Mapping Program Section Attributes to Image Section Attributes for Executable Images

Significant Psect Attribute Settings ¹				Type of Isect	Isect Attributes Set ²
NOWRT	NOEXE	NOVEC	³ MOD	NORMAL	—
WRT	NOEXE	NOVEC	³ MOD	"	WRT, CRF
NOWRT	EXE	NOVEC	³ MOD	"	⁴ EXE
WRT	EXE	NOVEC	³ MOD	"	WRT, CRF, ⁴ EXE
NOWRT	NOEXE	VEC	³ MOD	"	VECTOR, PROTECT

Significant Psect Attribute Settings ¹				Type of Isect	Isect Attributes Set ²
WRT	NOEXE	VEC	³ MOD	"	WRT, VECTOR, PROTECT, CRF
NOWRT	EXE	VEC	³ MOD	"	VECTOR, PROTECT, ⁴ EXE
WRT	EXE	VEC	³ MOD	"	WRT, VECTOR, PROTECT, ⁴ EXE
³ NOWRT	³ NOEXE	³ NOVEC	³ NOMOD	"	DZRO
³ WRT	³ NOEXE	³ NOVEC	³ NOMOD	"	WRT, DZRO ⁵

¹For Alpha images, these attributes are prefixed with EGPS\$V_. For VAX images, these attributes are prefixed with GPS\$V_.

²For Alpha images, these attributes are prefixed with EISD\$V_. For VAX images, these attributes are prefixed with ISD\$V_.

³Alpha specific

⁴For Alpha images, these attributes are prefixed with EGPS\$V_. For VAX images, these attributes are prefixed with GPS\$V_.

⁵If the /NODEMAND_ZERO qualifier is specified, the copy-on-reference (CRF) attribute is set instead of the DZRO attribute.

Table 7.3. Mapping Program Section Attributes to Image Section Attributes for Shareable Images

Significant Psect Attribute Settings ¹					Type of Isect	Isect Attributes Set ²	
NOWRT	NOEXE	SHR	NOPIC	NOVEC	³ MOD	SHRFXD	—
WRT	NOEXE	SHR	NOPIC	NOVEC	³ MOD	"	WRT
NOWRT	EXE	SHR	NOPIC	NOVEC	³ MOD	"	³ EXE
WRT	EXE	SHR	NOPIC	NOVEC	³ MOD	"	WRT, ³ EXE
NOWRT	NOEXE	NOSHR	NOPIC	NOVEC	³ MOD	PRVFXD	—
WRT	NOEXE	NOSHR	NOPIC	NOVEC	³ MOD	"	WRT, CRF
NOWRT	EXE	NOSHR	NOPIC	NOVEC	³ MOD	"	³ EXE
WRT	EXE	NOSHR	NOPIC	NOVEC	³ MOD	"	WRT, CRF, ³ EXE
NOWRT	NOEXE	SHR	PIC	NOVEC	³ MOD	SHRPIC	PIC
WRT	NOEXE	SHR	PIC	NOVEC	³ MOD	"	WRT, PIC
NOWRT	EXE	SHR	PIC	NOVEC	³ MOD	"	PIC, ³ EXE
WRT	EXE	SHR	PIC	NOVEC	³ MOD	"	WRT, PIC, ³ EXE
NOWRT	NOEXE	NOSHR	PIC	NOVEC	³ MOD	PRVPIC	PIC
WRT	NOEXE	NOSHR	PIC	NOVEC	³ MOD	"	WRT, CRF, PIC
NOWRT	EXE	NOSHR	PIC	NOVEC	³ MOD	"	PIC, ³ EXE
WRT	EXE	NOSHR	PIC	NOVEC	³ MOD	"	WRT, CRF, PIC, ³ EXE
NOWRT	NOEXE	SHR	NOPIC	VEC	³ MOD	SHRFXD	VECTOR, PROTECT
WRT	NOEXE	SHR	NOPIC	VEC	³ MOD	"	WRT, VECTOR, PROTECT

Significant Psect Attribute Settings ¹						Type of Isect	Isect Attributes Set ²
NOWRT	EXE	SHR	NOPIC	VEC	³ MOD	"	VECTOR, PROTECT, ³ EXE
WRT	EXE	SHR	NOPIC	VEC	³ MOD	"	WRT, VECTOR, PROTECT, ⁴ EXE
NOWRT	NOEXE	NOSHR	NOPIC	VEC	³ MOD	PRVFXD	VECTOR, PROTECT
WRT	NOEXE	NOSHR	NOPIC	VEC	³ MOD	"	WRT, CRF
NOWRT	EXE	NOSHR	NOPIC	VEC	³ MOD	"	VECTOR, PROTECT, ³ EXE
WRT	EXE	NOSHR	NOPIC	VEC	³ MOD	"	WRT, CRF, VECTOR, PROTECT, ⁴ EXE
NOWRT	NOEXE	SHR	PIC	VEC	³ MOD	SHRPIC	PIC, VECTOR, PROTECT
WRT	NOEXE	SHR	PIC	VEC	³ MOD	"	WRT, PIC, VECTOR, PROTECT
NOWRT	EXE	SHR	PIC	VEC	³ MOD	"	PIC, VECTOR, PROTECT, ³ EXE
WRT	EXE	SHR	PIC	VEC	³ MOD	"	WRT, PIC, VECTOR, PROTECT, ⁴ EXE
NOWRT	NOEXE	NOSHR	PIC	VEC	³ MOD	PRVPIC	PIC, VECTOR, PROTECT
WRT	NOEXE	NOSHR	PIC	VEC	³ MOD	"	WRT, CRF, PIC, VECTOR, PROTECT
NOWRT	EXE	NOSHR	PIC	VEC	³ MOD	"	PIC, VECTOR, PROTECT, ³ EXE
WRT	EXE	NOSHR	PIC	VEC	³ MOD	"	WRT, CRF, PIC, VECTOR, PROTECT, ³ EXE
³ NOWRT	³ NOEXE	³ SHR	³ NOPIC	³ NOVEC	³ NOMOD	SHRFXD	—
³ WRT	³ NOEXE	³ SHR	³ NOPIC	³ NOVEC	³ NOMOD	"	WRT
³ NOWRT	³ NOEXE	³ NOSHR	³ NOPIC	³ NOVEC	³ NOMOD	PRVFXD	DZRO
³ WRT	³ NOEXE	³ NOSHR	³ NOPIC	³ NOVEC	³ NOMOD	"	WRT, DZRO ⁴
³ NOWRT	³ NOEXE	³ NOSHR	³ PIC	³ NOVEC	³ NOMOD	PRVPIC	DZRO
³ WRT	³ NOEXE	³ NOSHR	³ PIC	³ NOVEC	³ NOMOD	"	WRT, DZRO ⁴ , PIC

Significant Psect Attribute Settings ¹						Type of Isect	Isect Attributes Set ²
³ NOWRT	³ NOEXE	³ SHR	³ PIC	³ NOVEC	³ NOMOD	SHRPIC	PIC
³ WRT	³ NOEXE	³ SHR	³ PIC	³ NOVEC	³ NOMOD	"	WRT, PIC

²For Alpha images, these attributes are prefixed with EISDSV_. For VAX images, these attributes are prefixed with ISDSV_.

³Alpha specific

⁴If the /NODEMAND_ZERO qualifier is specified, the copy-on-reference (CRF) attribute is set instead of the DZRO attribute.

For example, Table 7.4 summarizes the settings of the significant attributes of the program sections in the module MYADD.OBJ. (Because this is an OpenVMS VAX object module, the MOD attribute is not considered).

Table 7.4. Significant Attributes of Program Sections in MYSUB_CLUS Cluster

	Writability	Executability	Protected Vector
\$CODE	NOWRT	EXE	NOVEC
DATA	WRT	NOEXE	NOVEC
\$CHAR_STRING_CONSTANTS	WRT	NOEXE	NOVEC

The linker puts both the DATA and \$CHAR_STRING_CONSTANTS program sections in the same image section because they both have the same settings of significant attributes. Within the image section, the linker organizes the program sections alphabetically, so the \$CHAR_STRING_CONSTANTS program section appears before the DATA program section. The linker creates a separate image section for the \$CODE program section.

The linker performs similar processing of the program sections in the default cluster. The Image Section Synopsis section of the map file lists the clusters the linker created and lists the image sections it created for each cluster. This section also describes the layout of the image in memory, including the base address of each image section. Example 7.6 illustrates an excerpt of the Image Section Synopsis section from the map file produced with the sample link. The listing includes clusters for contributions for the VAX C Run-Time Library.

Example 7.6. Image Section Information in a Map File

```

+-----+
! Image Section Synopsis !
+-----+
Cluster      Type Pages  Base Addr  Disk VBN PFC Protection and Paging  ...
-----
MYSUB_CLUS   0      1    00000200      2  0  READ WRITE  COPY ON REF
              0      1    00000400      3  0  READ ONLY
VAXCRTL      3      4    00000000-R    0  0  READ ONLY
              3      1    00000800-R    0  0  READ ONLY
              4      1    00000A00-R    0  0  READ WRITE  COPY ON REF
              3     17    00000C00-R    0  0  READ ONLY
              3    142    00002E00-R    0  0  READ ONLY
              4     21    00014A00-R    0  0  READ WRITE  COPY ON REF
              4      1  P-00017400-R  0  0  READ WRITE  COPY ON REF
              2      3    00017600-R    0  0  READ WRITE  FIXUP VECTORS
LIBRTL       3     193    00000000-R    0  0  READ ONLY
              4      8    00018200-R    0  0  READ WRITE  DEMAND ZERO
MTHRTL       3     335    00000000-R    0  0  READ ONLY
              2      1    00029E00-R    0  0  READ WRITE  FIXUP VECTORS
DEFAULT_CLUSTER 0      1    00000600      4  0  READ WRITE  COPY ON REF
              0      1    00000800      5  0  READ ONLY
              0      1    00000A00      6  0  READ WRITE  FIXUP VECTORS
              253   20    7FFFD800      0  0  READ WRITE  DEMAND ZERO

```

For more information about the image section synopsis section of a map file, see Section 9.2.3.

To find out which program sections the linker placed in each image section, look at the Program Section Synopsis section of the map file. This section lists all the program sections in each cluster and lists the contributions (the number of bytes) to each program section from each object module. By comparing the base-address of the program sections with the base-addresses of the image sections in the Image Section Synopsis section, you can tell in which image section the program sections appear. Example 7.7 is an excerpt from the Program Section Synopsis section of the map file produced by the sample link operation.

Example 7.7. Program Section Information in a Map File (VAX Example)

```

+-----+
! Program Section Synopsis !
+-----+
Psect Name Module Name   Base      End      Length      Align      Attributes
-----
$DATA
    MYSUB      00000200 00000203 00000004 ( 4.) LONG 2 PIC,USR,CON ...
GLOBAL_DATA
    MYSUB      00000204 00000207 00000004 ( 4.) LONG 2 PIC,USR,OVR ...
    MYTEST     00000204 00000207 00000004 ( 4.) LONG 2
$CODE
    MYSUB      00000400 0000040B 0000000C (12.) LONG 2 PIC,USR,CON ...
$CHAR_STRING_CONSTANTS
    MYTEST     00000600 00000623 00000024 (36.) LONG 2 PIC,USR,CON ...
    MYADD      00000624 0000062D 0000000A (10.) LONG 2
$DATA
    MYTEST     00000630 00000637 00000008 ( 8.) LONG 2 PIC,USR,CON ...
    MYADD      00000634 00000637 00000004 ( 4.) LONG 2
$CODE
    MYTEST     00000800 00000858 00000059 (89.) LONG 2 PIC,USR,CON ...
    MYADD      00000800 0000083E 0000003F (63.) LONG 2
    MYADD      00000840 00000858 00000019 (25.) LONG 2
.
.
.

```

For more information about the program synopsis section of a map file, see Section 9.2.4.

7.3.4. Allocating Memory for Image Sections

When it creates an image section, the linker allocates enough memory for the image section to accommodate all the program sections it contains. Each program section definition includes its size.

The linker aligns image sections on CPU-specific page boundaries. Within an image section, the linker assigns to each program section a virtual address relative to the base address of the image section.

Concatenated Program Sections

If the program sections have the concatenated (CON) attribute set, the linker positions the program sections one after the other within an image section, inserting padding bytes between the program sections if necessary to achieve the alignment requirement of a particular contribution to a program section. The linker retains the alignment specified for each program section contribution but uses the largest alignment of a contributing module as the alignment of the whole program section.

Overlaid Program Sections

If the program sections have the overlaid (OVR) attribute set, the linker uses the same start address for the program sections so that they occupy the same virtual memory (that is, the program sections overlay each other). For overlaid program sections, the linker allocates enough space to accommodate

the largest of all the program section contributions. Note that the linker does *not* generate a warning message if the contributions specify different size allocations.

Any module can initialize the contents of an overlaid program section. However, the final contents of the program section are determined by the last contributing module. Therefore, the order in which you specify the input modules is important.

Assigning Virtual Addresses

The linker keeps track of free (available) virtual addresses by maintaining a free virtual memory list. For each cluster, the linker determines the number of pages required, searches the list beginning at the lowest virtual address for a contiguous number of pages large enough to contain the cluster, allocates those addresses to the cluster, then removes those addresses from the list.

The linker allocates virtual memory to the first cluster beginning at a page size boundary for executable images in the P0 region of the user's virtual address space, unless the cluster is based, in which case it allocates virtual memory beginning at the specified address. For VAX linking, the default is 512 (200 hexadecimal). However, you can specify the page size using the `/BPAGE` qualifier. For information about the `/BPAGE` qualifier, see Chapter 10.

On its first pass through the cluster list, the linker allocates virtual addresses to any based user clusters or based shareable image clusters on the cluster list, removing the allocated addresses from the free virtual memory list as it proceeds. On its second pass, it repeats this procedure for non based user clusters. (Remember that non based shareable image clusters will have memory allocated for them at run-time).

Because the linker processes clusters in the order of their appearance on the cluster list, the virtual address space of the final image will generally contain contiguous image sections of consecutive clusters on the basis of their order in the cluster list. The presence of based clusters, however, may prevent such an outcome, and for this reason they are not recommended.

After allocating memory for a cluster, the linker relocates its contents by performing the following processing:

1. **Relocating each image section.** The linker adds the starting virtual address of the cluster to the relative offset of the image section from the cluster base and places the result in the appropriate field of the image section descriptor (ISD).
2. **Relocating each program section in the image section.** The linker adds the newly calculated starting virtual address of the image section to the relative offset of the program section from the base of the image section.
3. **Relocating each global symbol in the program section.** The linker adds the newly calculated program section virtual address to the relative offset of the global symbols from the base of the program section.

7.3.5. Image Section Attributes

When it creates image sections, the linker assigns attributes to the image section based on the attributes of the program sections it contains. The image section attributes describe certain characteristics of the portion of memory they represent, for example, the protection characteristics. For example, an image section that contains program sections with the writability attribute also has the writability attribute set. Tables 7.2 and 7.3 include the image section attributes associated with an

image section that contains program sections with a particular set of attributes. Table 7.5 lists all the image section attributes. Image section attributes, like program section attributes, are Boolean values that are either on or off.

Table 7.5. Image Section Attributes

Attribute	Symbol	Function
Global	[E]ISD\$M_GBL	GBL is set when the ISD came from a shareable image. On both VAX and Alpha systems, the first ISD of a shareable image is included in the base image for use by the image activator. For VAX linking, if the shareable image is based, all of its ISDs are included in the image being linked.
Copy On Reference	[E]ISD\$M_CRF	CRF is set whenever the psect attributes are WRT and not SHR. CRF is also set by the linker whenever it creates fix-ups to the section (which require the image activator to write to it).
Demand Zero	[E]ISD\$M_DZRO	<p>Demand zero is set for VAX linking for executable images if:</p> <ul style="list-style-type: none"> • The section was never written to with a TIR (Text and Information Relocation) command. • The section resulted from compression of empty pages from an existing section. <p>Demand zero is set for Alpha executable and Alpha shareable images if the user has not specified /NODEMAND_ZERO and if:</p> <ul style="list-style-type: none"> • The section was never written to with an ETIR command. • The program sections in the section have the NOMOD bit set. <p>DZRO is always set for stack ISDs on both Alpha images and VAX images.</p>
Executability	[E]ISD\$M_EXE	The EXE attribute is inherited from the program section.
Write	[E]ISD\$M_WRT	The WRT attribute is inherited from the program section. WRT is also set by the linker if fix-ups are made to the section. When this is done, the linker also generates a change protection fix-up so that the image activator can change the protection back to NOWRT after the fix-up is applied.
Match Control	ISD\$M_MATCHCTL	This is used only for VAX images. It is not an attribute. MATCHCTL is a 3-bit field inside the flags field. It contains the match control bits. For Alpha images, this information is contained in a completely separate field.

Attribute	Symbol	Function
Last Cluster	[E]ISD\$M_LASTCLU	LASTCLU is set only for sections inexecutable images. LASTCLU indicates that an image section was generated off of the last cluster (which was not a shareable image cluster) in the cluster list. If FIXUPVEC is set, LASTCLU is clear.
Initial Code	[E]ISD\$M_INITALCODE	This attribute is reserved to OpenVMS.
Based	[E]ISD\$M_BASED	BASED indicates that the section is based. This is set when BASE= is specified in the options file. This attribute may also be set if based shareable images are encountered during linking. This attribute is present but not used for Alpha linking.
Fix-Up Vectors	[E]ISD\$M_FIXUPVEC	FIXUPVEC marks the section that contains the image activator fix-ups. This section is created by the linker. The attribute cannot be set by the user.
Resident	[E]ISD\$M_RESIDENT	This attribute is reserved to OpenVMS.
Vectored	[E]ISD\$M_VECTOR	VECTOR indicates a vectored section, either a message section or a privileged library vector.
Protected	[E]ISD\$M_PROTECT	Protect indicates that a section is protected. The linker sets the PROTECT attribute whenever VECTOR is set. PROTECT is also set if the /PROTECT qualifier is used, or if the cluster that the section is spawned from came after a PROTECT=YES option (and before a PROTECT=NO option).

The linker uses type designations instead of image section attributes to propagate the SHR and PIC program section attributes. The linker assigns the type designation [E]ISD\$K_NORMAL for image sections in executable images. Image sections in shareable images can be any of the following types:

Image Section Type	Attribute Settings
Share fixed ([E]ISD\$K_SHRFXD)	SHR, NOPIC
Private fixed ([E]ISD\$K_PRVFXD)	NOSHR, NOPIC
Share position-independent ([E]ISD\$K_SHRPIC)	SHR, PIC
Private position-independent ([E]ISD\$K_PRVPIC)	NOSHR, PIC

The Image Section Synopsis section of a map file lists the attributes of each image section created in the Protection and Paging column. See Example 7.6 for an illustration. You can also get a listing of all the image sections created by the linker by using the ANALYZE/IMAGE utility. The output generated by this utility includes a list of all the image sections that make up the image, with their attributes. An excerpt from the analysis of the image file MYTEST.EXE is shown in Example 7.8.

Example 7.8. Image Section Descriptions in an ANALYZE/IMAGE Display

```
Image Section Descriptors (ISD)
1) ❶ image section descriptor (16 bytes)
    ❷ page count: 1
    ❸ base virtual address: %X'00000200' (P0 space)
    ❹ page fault cluster size: default
```

```

5 IS flags:
(0) ISD$V_GBL      0
(1) ISD$V_CRF     1
(2) ISD$V_DZRO    0
(3) ISD$V_WRT     1
(7) ISD$V_LASTCLU 0
(8) ISD$V_INITALCODE 0
(9) ISD$V_BASED   0
(10) ISD$V_FIXUPVEC 0
(11) ISD$V_RESIDENT 0
(17) ISD$V_VECTOR 0
(18) ISD$V_PROTECT 0

6 section type: ISD$K_NORMAL
7 base VBN: 2
.
.
.
9) image section descriptor (31 bytes)
page count: 193
base virtual address: %X'00000000' (P0 space)
page fault cluster size: default
IS flags:
(0) ISD$V_GBL      1
(1) ISD$V_CRF     0
(2) ISD$V_DZRO    0
(3) ISD$V_WRT     0
(7) ISD$V_LASTCLU 0
(8) ISD$V_INITALCODE 0
(9) ISD$V_BASED   0
(10) ISD$V_FIXUPVEC 0
(11) ISD$V_RESIDENT 0
(17) ISD$V_VECTOR 0
(18) ISD$V_PROTECT 0
section type: ISD$K_SHRPIC
base VBN: 0
8 global section major id: %X'01', minor id: %X'00000E'
9 match control: ISD$K_MATLEQ
10 global section name: "LIBRTL_001"

```

- 1 The size of the image section descriptor.
- 2 The size of the image section, expressed in pages. For Alpha images, the value is expressed in bytes.
- 3 The start address assigned to the image section by the linker. Note that this address is an offset from the beginning of the image, which is assumed to start at virtual address zero. (The linker always inserts an empty page at the beginning of every executable image). Note also that the linker does not assign a start address for image sections representing shareable images because this information cannot be determined until run-time, when the shareable image is loaded into memory by the image activator.
- 4 The number of pagelets that should be mapped in when the initial page fault occurs. You can set this value by using the CLUSTER= option.
- 5 The settings of image section attributes. Table 7.5 lists these attributes.
- 6 The type of image section, based on the combination of image section attributes.
- 7 The virtual block in the image file at which the image section begins.
- 8 Image sections that represent shareable images include the global section identification number, which specifies the identification number of the shareable image.
- 9 Image sections that represent shareable images also include a match control field that identifies the match control algorithm the image activator should apply to the global image section identification number when it activates the shareable image this ISD describes.
- 10 Image sections that represent shareable images include the global section name field, which is the name of the shareable image. The “_001” is appended to the name by the linker to indicate which ISD in the image this represents.

7.3.6. Controlling Image Section Creation

You can control how the linker combines program sections into image sections in the following ways:

- By modifying the attributes of program sections
- By putting object modules into named clusters
- By using the SOLITARY attribute

7.3.6.1. Modifying Program Section Attributes

The linker combines program sections in the same cluster into the same image section if they have the same settings for the significant program section attributes. To force the linker to put the program sections into different image sections, change the attributes of one of the program sections by using the PSECT_ATTR= option.

For example, in the sample link operation, the DATA program section and the \$CHAR_STRING_CONSTANTS program section are combined into the same image section. If you want the \$CHAR_STRING_CONSTANTS program section to appear in a different image section, change one of the significant attributes. For example, in the following link of the sample programs, the writability attribute is set to NOWRT. (For Alpha linking, you do not need to explicitly specify the C Run-Time Library in the link operation because it resides in the default system shareable image library [IMAGELIB.OLB], which the linker processes by default).

```
$ LINK/MAP/FULL MYTEST,MYADD,SYS$INPUT/OPT
CLUSTER=MYSUB_CLUS,,MYSUB
PSECT_ATTR=$CHAR_STRING_CONSTANTS,NOWRT
SYS$LIBRARY:VAXCRTL/SHARE
Ctrl/Z
```

Example 7.9 presents an excerpt from the Image Section Synopsis section of the map file produced by this link.

Example 7.9. Image Section Synopsis of Second Link

Cluster	Type	Pages	Base	Addr	Disk	VCN	PFC	Protection and Paging ...
.....
	.							
	.							
	.							
DEFAULT_CLUSTER	0	1	00000600		4	0	0	READ ONLY
	0	1	00000800		0	0	0	READ WRITE DEMAND ZERO
	0	1	00000A00		5	0	0	READ ONLY
	0	1	00000C00		6	0	0	READ WRITE FIXUP VECTORS
	253	20	7FFFD800		0	0	0	READ WRITE DEMAND ZERO
	.							
	.							
	.							

Note that the default cluster contains one additional image section, a read-only image section beginning at virtual address 0x00000600, than the default cluster in the original link, illustrated in Section 7.3.1.

7.3.6.2. Manipulating Cluster Creation

In general, the linker creates image sections on a per-cluster basis; that is, only program sections within a particular cluster can contribute to image section creation. (The linker can collect program

sections with the global attribute from all clusters into a single image section). To ensure that a program section appears in a particular image section, put the program section in a specific cluster.

For example, in the sample link operation illustrated in Example 7.5, the linker puts all the program sections in the object module MYSUB.OBJ in the cluster named MYSUB_CLUS because the CLUSTER= option is specified. If you wanted to group all of the program sections that contain code from all the other clusters into the MYSUB_CLUS cluster, you could specify the COLLECT= option, as in the following example. (By convention, VAX language processors put the code they generate into program sections named \$CODE. Program section naming conventions are architecture specific).

```
$ LINK/MAP/FULL MYTEST, MYADD, SYS$INPUT/OPT
CLUSTER=MYSUB_CLUS, , MYSUB
COLLECT=MYSUB_CLUS, $CODE
SYS$LIBRARY:VAXCRTL/SHARE
Ctrl/Z
```

7.3.6.3. Isolating a Program Section into an Image Section

You can specify that the linker place a particular program section into its own image section. This can be useful for programs that map data into predefined locations within an image.

To isolate a program section into an image section, specify the SOLITARY attribute of the program section using the PSECT_ATTR= option. For example, to isolate the GLOBAL_DATA program section in the sample link into its own image section, specify the following:

```
$ LINK/MAP/FULL MYTEST, MYADD, SYS$INPUT/OPT
CLUSTER=MYSUB_CLUS, , MYSUB
PSECT_ATTR=GLOBAL_DATA, SOLITARY
Ctrl/Z
```

For Alpha linking, when mapping data into an existing location in the virtual memory of your program using the Create and Map Global Section (\$CRMPSC) system service or the Map Global Section (\$MGBLSC) system service, you must specify an address range (in the *inadr* argument) that is aligned on a CPU-specific page boundary. Because the linker aligns image sections on CPU-specific page boundaries and the program section in which the section is to be mapped is the only program section in the image section, you ensure that the start address of the location is page aligned. In addition, because Alpha systems must map at least an entire page of memory at a time, using the SOLITARY attribute allows you to ensure that no other data in the image section is inadvertently overwritten by the mapping. By default, the linker creates the next image section on the next page boundary so that no data can be overwritten.

7.4. Initializing an Image on Alpha/VAX Systems

After allocating memory for the image, the linker initializes the image by writing the binary contents of the image sections by processing text information and relocation (TIR) records in the object modules. These records direct the linker in the initialization of the image section by telling it what to store in the image section buffers. In addition, the linker inserts the addresses of symbols within the image wherever they are referenced.

7.4.1. Writing the Binary Contents of Image Sections

A TIR record contains object language commands, such as stack and store commands. Stack commands direct the linker to put information on its stack, and store commands direct the linker to write the information from its stack to the buffer for that image section.

During this image section initialization, the linker keeps track of the program section being initialized and the image section to which it has been allocated. The first attempt to initialize part of an image section by storing nonzero data causes the linker to allocate a buffer in its own program region to contain the binary contents of the generated image section. This allocation is achieved by the Expand Region (\$EXPREG) system service, and it requires that the linker have available a virtually contiguous region of its own memory at least as large as the image section being initialized.

A buffer is not allocated for an image section until the linker executes a store command (with nonzero data) within that image section.

Debugger information (DBG) records and traceback information (TBT) records are processed only if the debugger was requested and traceback information was not excluded by the /NOTRACE qualifier in the LINK command. Otherwise, these records are ignored. The records contain stack and store object language commands (TIR records), but they are stored in the debugger symbol table (DST) instead of in an image section. (The linker expands its memory region to accommodate the DST, unless the /NOTRACEBACK qualifier was specified in the LINK command).

When the linker processes end-of-module (EOM) records, it checks that its internal stack has been collapsed to its initial state. When this processing is complete, the linker has written the binary contents of all image sections to image section buffers in its own address space.

The linker writes the contents of its buffers in the following order:

1. All image sections to the image file.
2. The debugger symbol table to the image file, unless /NOTRACEBACK was specified in the LINK command.
3. The remaining sections of the map to the map file, if requested in the LINK command. (These sections include all requested sections except the Object Module Synopsis, which it already wrote, and the Link Run Statistics, which it cannot write until the linking operation finishes).
4. The global symbol table to the image file, and also to another separate file, if requested in the LINK command.
5. The image header to the image file.
6. The link statistics to the map file, if requested in the LINK command.

7.4.2. Fixing Up Addresses

Executable images and based images are loaded into memory at a known location in P0 space. The linker cannot know where in memory a shareable image will be located when it is loaded into memory at run-time by the image activator. Thus, the linker cannot initialize references to symbols within the shareable image from external modules or to internal symbolic references within the shareable image itself. For shareable images, the linker creates **fix-ups** that the image activator must resolve when it activates the images at run-time.

The linker uses the fix-up image section in the following ways:

- The fix-up image section adjusts the values stored by any .ADDRESS directives that are encountered during the creation of the non based shareable image. This action, together with subsequent adjustment of these values by the image activator, preserves the position independence of the shareable image.

On Alpha systems, an error message informs you at link time that the linker is placing global symbols from shareable images in byte- or word-sized fields. The OpenVMS Alpha image header format does not allow byte or word fix-ups.

Following is an example of the kind of error message the system displays:

```
%LINK-E-NOFIXSYM, unable to perform WORD fixup for symbol TPU$_OPTIONS
      in psect $PLIT$ in module TEST_MODULE file USER:[ACCOUNT]TEST.OLB;1
```

To work around the Alpha image header format restriction, move the symbolic value into a selected location at run-time rather than at link time. For example, in MACRO, rather than performing `.WORD TPU$_OPTIONS`, use the following instruction:

```
MOVW #TPU$_OPTIONS, dest
```

- For VAX linking, the fix-up image section processes all general-address-mode code references to targets in position-independent shareable images. In this way, it creates the linkage between these code references and their targets, whose locations are not known until run-time.

7.4.3. Keeping the Size of Image Files Manageable

Because neither language processors nor the linker initialize data areas in a program with zeros, leaving this task to the operating system instead, some image sections might contain uninitialized pages. To keep the size of the image file as small as possible, the linker does not write pages of zeros to disk for these uninitialized pages unless you explicitly disable this function. The linker can search image sections that contain initialized data for groups of contiguous, uninitialized pages and creates demand-zero image sections out of these pages (called **demand-zero compression**). Demand-zero image sections reduce the size of the image file and enhance the performance of the program. At run-time, when a reference is made that initializes the section, the operating system initializes the allocated page of physical memory with zeros (hence the name “demand-zero”).

The Alpha compilers identify to the linker program sections that have not been initialized by setting the NOMOD attribute of the program section. The linker groups these uninitialized program sections into a demand-zero image section.

If two modules contribute to the same program section and one contribution has the NOMOD attribute set and the other does not, the linker performs a logical AND of the NOMOD bits so that the two contributions end up in the same (non-demand-zero) image section.

Note that the linker creates demand-zero image sections only for OpenVMS VAX executable images. On OpenVMS Alpha systems, the linker can create demand-zero image sections for both executable and shareable images. Program sections with the SHR and the NOMOD attributes set are not sorted into demand-zero image sections in shareable images.

7.4.3.1. Controlling Demand-Zero Image Section Creation

When performing demand-zero compression, by default the linker searches the pages of existing image sections looking for the default minimum of contiguous, uninitialized pages. You can specify a different minimum by using the `DZRO_MIN=` option. For more information about the effect of this option on image size and performance, see the description of the `DZRO_MIN=` option in Chapter 10.

You can control demand-zero compression by specifying the maximum number of image sections that the linker can create using the `ISD_MAX=` option.

Chapter 8. Creating Shareable Images (Alpha and VAX)

This chapter describes how to create shareable images on OpenVMS Alpha and OpenVMS VAX systems and how to declare universal symbols in shareable images.

For information on how to create shareable images on OpenVMS x86-64 and OpenVMS I64 systems, see Chapter 4.

8.1. Overview of Creating Shareable Images on Alpha/VAX Systems

To create a shareable image, specify the `/SHAREABLE` qualifier on the `LINK` command line. You can specify as input files in the link operation any of the types of input files accepted by the linker, as described in Chapter 1.

Note, however, to enable other modules to reference symbols in the shareable image, you must declare them as universal symbols. High- and mid-level languages do not provide semantics to declare universal symbols. You must declare universal symbols at link time using linker options. The linker lists all universal symbols in the global symbol table (GST) of the shareable image. The linker processes the GST of a shareable image specified as an input file in a link operation during symbol resolution. For more information about symbol resolution, see Chapter 6.

For Alpha linking, you declare universal symbols by listing the symbols in a `SYMBOL_VECTOR=` option statement in a linker options file. You do not need to create a transfer vector to create an upwardly compatible shareable image. The symbol vector can provide upward compatibility. For more information about this topic, see Section 8.3.

For VAX linking, you declare universal symbols by listing the symbols in a `UNIVERSAL=` option statement in a linker options file. You can create shareable images that can be modified, recompiled, and relinked without causing the images that were linked against previous versions of the shareable image to be relinked. To provide this upward compatibility, you must create a **transfer vector** that contains an entry for each universal symbol in the image. For more information about these topics, see Section 8.2.

The linker supports qualifiers and options that control various aspects of shareable image creation. Table 8.1 lists these qualifiers and options. For more information about linker qualifiers and options, see Chapter 10.

Table 8.1. Linker Qualifiers and Options Used to Create Shareable Images

Qualifier	Description
<code>/GST¹</code>	For Alpha images, directs the linker to include universal symbols in the global symbol table (GST) of the shareable image, which is the default. When you specify the <code>/NOGST</code> qualifier, the linker creates an empty GST for the image. See Section 8.3.4 for more information about using this qualifier to create run-time kits. Not supported for VAX images.
<code>/PROTECT</code>	Directs the linker to protect the shareable image from write access by user or supervisor mode.

Qualifier	Description
/SHAREABLE	Directs the linker to create a shareable image, when specified in the link command line. When appended to a file specification in a linker options file, this qualifier identifies the input file as a shareable image.
Option	Description
GSMATCH=	Sets the major and minor identification numbers in the header of the shareable image and specifies the algorithm the linker uses when comparing identification numbers.
PROTECT=	When specified with the YES keyword in a linker options file, this option directs the linker to protect the clusters created by subsequent options specified in the options file. You turn off protection by specifying the PROTECT=NO option in the options file.
SYMBOL_TABLE= ¹	For Alpha linking, when specified with the GLOBALS keyword, this option directs the linker to include in a symbol table file all the global symbols defined in the shareable image, in addition to the universal symbols. By default, the linker includes only universal symbols in a symbol table file associated with a shareable image (SYMBOL_TABLE=UNIVERSALS). Not supported for VAX linking.
SYMBOL_VECTOR= ¹	For Alpha linking, specifies symbols in the shareable image that you want declared as universal. Not supported for VAX linking.
UNIVERSAL= ²	For VAX linking, specifies symbols in the shareable image that you want declared as universal. Not supported for Alpha linking.

¹Alpha specific²VAX specific

8.2. Declaring Universal Symbols in VAX Shareable Images

For VAX linking, you declare universal symbols by specifying the UNIVERSAL=option in an options file. List the symbol or symbols you want to be universal as an argument to the option. The symbols listed in a UNIVERSAL= option can represent procedures, relocatable data, or constants. For each symbol declared as universal, the linker creates an entry in the global symbol table (GST) of the image. At link time, when the linker performs symbol resolution, it processes the symbols listed in the GSTs of the shareable images included in the link operation.

To illustrate how to declare universal symbols, consider the programs in the following examples.

Example 8.1. Shareable Image Test Module: my_main.c

```
#include <stdio.h>
extern int my_data;
globalref int my_symbol;
int mysub();
main()
{
  int num1, num2, result;
  num1 = 5;
  num2 = 6;
  result = mysub( num1, num2 );
  printf("Result= %d\n", result);
  printf("Data implemented as overlaid psect= %d\n", my_data);
  printf("Global reference data is= %d\n", my_symbol);
}
```

Example 8.2. Shareable Image: my_math.c

```

int my_data = 5;
globaldef int my_symbol = 10;
myadd(value_1, value_2)
int value_1;
int value_2;
{
int result;
result = value_1 + value_2;
return( result );
}
mysub(value_1,value_2)
int value_1;
int value_2;
{
int result;
result = value_1 - value_2;
return( result );
}
mydiv( value_1, value_2 )
int value_1;
int value_2;
{
int result;
result = value_1 / value_2;
return( result );
}
mymul( value_1, value_2 )
int value_1;
int value_2;
{
int result;
result = value_1 * value_2;
return( result );
}

```

To implement Example 8.2 as a shareable image, you must declare the universal symbols in the image by using the following LINK command:

```

$ LINK/SHAREABLE MY_MATH, SYS$INPUT/OPT
PSECT_ATTR=my_data,NOSHR
UNIVERSAL=myadd
UNIVERSAL=mysub
UNIVERSAL=mymul
UNIVERSAL=mydiv
UNIVERSAL=my_symbol
Ctrl/Z

```

Note that the symbol `my_data` in Example 8.2 does not have to be declared universal because of the way in which VAX C implements it. Several programming languages, including VAX C and Fortran for OpenVMS VAX, implement certain external variables as program sections with the overlaid (OVR), global (GBL), and relocatable (REL) attributes. When the linker processes these object modules, it **overlays** the program sections so that the various object modules that reference the variable access the same virtual memory. Symbols implemented in this way are declared universal (appear in the GST of the image) by default.

In the sample link operation, the SHR attribute of the program section that implements the data symbol `my_data` is reset to NOSHR. If you do not reset the shareable attribute for program sections that are writable, you must install the shareable image to run the program. (The shareable attribute [SHR] determines whether multiple processes have shared access to the memory).

The following example illustrates how to link the object module `MY_MAIN.OBJ` with the shareable image `MY_MATH.EXE`. Note that the LINK command sets the shareability attribute of the program section `my_data` to NOSHR, as in the link operation in which the shareable was created.

```
$ LINK MY_MAIN, SYS$INPUT/OPT
MY_MATH/SHAREABLE
PSECT_ATTR=my_data,NOSHR
Ctrl/Z
```

8.2.1. Creating Upwardly Compatible Shareable Images (VAX Only)

For VAX linking, you can create a shareable image that can be modified, recompiled, and relinked without causing the images that were linked against previous versions of the image to be relinked. To provide this upward compatibility, you must ensure that the values of relocatable universal symbols within the image remain constant with each relinking.

Universal Symbols that Represent Procedures

To fix the locations of universal symbols that represent procedures in shareable image, create a **transfer vector** for the shareable image. In a transfer vector, you create small routines in VAX MACRO that define an entry point in the image and then transfer control to another location in memory. You declare the entry points defined in the transfer vector as the universal symbols and have each routine transfer control to the actual location of the procedures within the shareable image. As long as you ensure that the location of the transfer vector remains the same with each relinking, images that linked with previous versions of the shareable image will access the procedures at the locations they expect.

Figure 8.1 illustrates the flow of control at run-time between a main image and a shareable image in which the actual routines are declared as universal symbols (as shown in Section 8.2) and between a main image and a shareable image in which the transfer vector entry points are declared as universal symbols (as shown in Section 8.2.1.1).

Figure 8.1. Comparison of UNIVERSAL= Option and Transfer Vectors

Accessing symbols by using the UNIVERSAL=option:

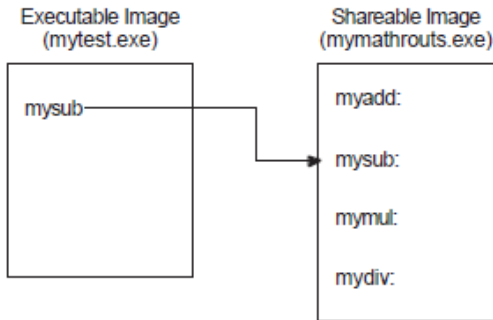

Accessing symbols by using transfer vectors:

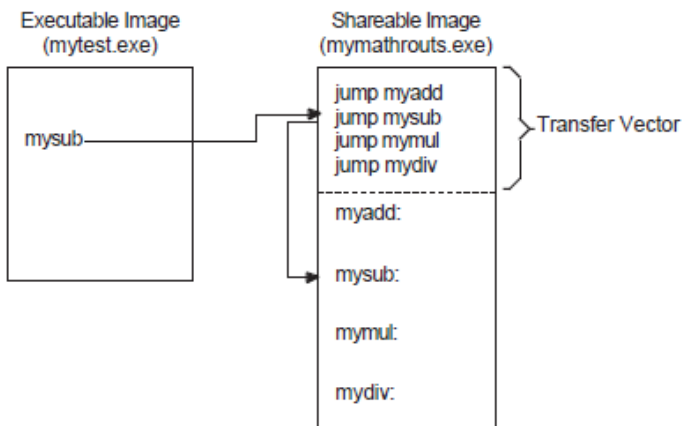

ZK-5089A-GE

Universal Symbols that Represent Data

To provide upwardly compatible symbols that represent data locations, you must also fix these locations within memory. You can accomplish this by allocating the data symbols at the end of the transfer vector file. In this way, when you fix the location of the transfer vector within an image, the data locations also remain the same.

8.2.1.1. Creating a Transfer Vector (VAX Only)

You create a transfer vector using VAX MACRO. Specify the .TRANSFER directive because it declares the symbol that you specify as its argument as a universal symbol by default. VSI recommends the following coding conventions for creating a transfer vector:

```

❶ .transfer    FOO          ;Begin transfer vector to FOO
❷ .mask       FOO          ;Store register save mask
❸ jmp         L^FOO+2      ;Jump to routine

```

- ❶ The .TRANSFER directive causes the symbol, named FOO in the example, to be added to the shareable image's global symbol table. (You do not need to also specify the symbol in a UNIVERSAL= statement in a linker options file).
- ❷ The .MASK directive causes the assembler to allocate 2 bytes of memory, find the register save mask accompanying the entry point (FOO in the example), and store the register save mask of the procedure. (According to the OpenVMS calling standard, procedure calls using the CALLS

or CALLG instructions include a word, called the register save mask, whose bits represent which registers must be preserved by the routine).

- ③ The JMP instruction transfers control to the address specified as its argument. In the example, this address is two bytes past the routine entry point FOO (the first two bytes of the routine are the register save mask).

It is recommended to use a jump instruction (for example, JMP L^) in the transfer vector. Transferring control with a BSBW or JSB instruction results in saving the address of the next instruction from the transfer vector on the stack. In addition, the displacement used by the BSBW instruction must be expressible in 16 bits, which may not be sufficient to reach the target routine. Also, to avoid making the image position dependent, do not use an absolute mode instruction.

Note that the preceding convention assumes that the routine is called using the procedure call format, the default for most high-level language compilers. If a routine is called as a subroutine, using the JSB instruction, you do not need to include the .MASK directive. When creating a transfer vector for a subroutine call, VSI recommends adding bytes of padding to the transfer vectors. This padding makes a subroutine transfer vector the same size as a transfer vector for a procedure call. If you need to replace a subroutine transfer vector with a procedure call transfer vector, you can make the replacement without disturbing the addresses of all the succeeding transfer vectors.

The following example illustrates a subroutine transfer vector that uses the .BLKB directive to allocate the padding:

```
.TRANSFER FOO ;Begin transfer vector to FOO
JMP L^FOO ;Jump to routine
.BLKB 2 ;Pad vector to 8 bytes
```

To ensure upward compatibility, follow these guidelines when creating a transfer vector:

- Preserve the order and placement of entries in a transfer vector. Once you establish the order in which entries appear in a transfer vector, do not change it. Images that were linked against the shareable image depend on the location of the symbol in the transfer vector.

You can reserve space within a transfer vector for future growth by specifying dummy transfer vector entries at various positions in a transfer vector.

- Add new entries to the end of a transfer vector. When including universal data in a transfer vector file, use padding to leave adequate room for future growth between the end of the transfer vector and the beginning of the list of universal data declarations.

A transfer vector for the program in Example 8.2 is illustrated in Example 8.3.

Example 8.3. Transfer Vector for the Shareable Image MY_MATH.EXE

```
.transfer myadd
.mask myadd
jmp l^myadd+2
.transfer mysub
.mask mysub
jmp l^mysub+2
.transfer mymul
.mask mymul
jmp l^mymul+2
.transfer mydiv
.mask mydiv
jmp l^mydiv+2
.end
```

Assemble the transfer vector file to create an object module that can be included in a link operation:

```
$ MACRO MY_MATH_TRANS_VEC.MAR
```

8.2.1.2. Fixing the Location of the Transfer Vector in Your Image (VAX Only)

For VAX linking, you include a transfer vector in a link operation as you would any other object module. However, to ensure upward compatibility, you must make sure that the transfer vector always appears in the same location in the image. The best way to accomplish this is to make the transfer vector always appear at the beginning of the image by forcing the linker to process it first. If you put the transfer vector file in a named cluster, using the `CLUSTER=option`, and specify it as the first option in an options file that can generate a cluster, the transfer vector will appear at the beginning of the file. For more information about controlling cluster creation, see Section 6.3.

The following example illustrates how to include the transfer vector in the link operation, using the `CLUSTER=` option, so that the linker processes it first:

```
$ LINK/SHAREABLE MY_MATH, SYS$INPUT/OPT
❶ GSMATCH=lequal,1,1000
❷ CLUSTER=trans_vec_clus,,,MY_MATH_TRANS_VEC.OBJ
Ctrl/Z
```

- ❶ To enable images that linked against a shareable image to run with various versions of the shareable image, you must specify the identification numbers of the image. By default, the linker assigns a unique identification number to each version of a shareable image. At run-time, if the ID of the shareable image as it is listed in the executable image does not match the ID of the shareable image the image activator finds to activate, the activation will abort. For information about using the `GSMATCH=` option to specify ID numbers, see the description of the `GSMATCH=` option Chapter 10.
- ❷ This `CLUSTER=` option causes the linker to create the named cluster `TRANS_VEC_CLUS` and to put the transfer vector file in this cluster.

8.2.2. Creating Based Shareable Images (VAX Linking Only)

For VAX linking, you can create a **based** shareable image by specifying the `BASE=` option in a linker options file. In a based image, you specify the starting address at which you want the linker to begin allocating memory for the image. For more information about the `BASE=` option, see Chapter 10.

VSI does not recommend using based shareable images.

Based shareable Alpha images are not supported.

8.3. Declaring Universal Symbols in Alpha Shareable Images

For Alpha linking, you declare universal symbols by listing them in a `SYMBOL_VECTOR=` option. For each symbol listed in the `SYMBOL_VECTOR=` option, the linker creates an entry in the shareable image's symbol vector and creates an entry for the symbol in the shareable image's global symbol table (GST). When the shareable image is included in a subsequent link operation, the linker processes the symbols listed in its GST.

To implement Example 8.2 as an Alpha shareable image, you must declare the universal symbols in the image by using the following LINK command:

```
$ LINK/SHAREABLE MY_MATH, SYS$INPUT/OPT
GSMATCH=lequal,1,1000
SYMBOL_VECTOR=(myadd=PROCEDURE,-
mysub=PROCEDURE,-
mymul=PROCEDURE,-
mydiv=PROCEDURE,-
my_symbol=DATA,-
my_data=PSECT)
Ctrl/Z
```

You must identify the type of symbol vector entry you want to create by specifying a keyword. The linker allows you to create symbol vector entries for procedures, data (relocatable or constant), and for global data implemented as an overlaid program section.

A symbol vector entry is a pair of quadwords that contains information about the symbol. The contents of these quadwords depends on what the symbol represents. If the symbol represents a procedure, the symbol vector entry contains the address of the procedure entry point and the address of the procedure descriptor. If the symbol represents a data location, the symbol vector entry contains the address of the data location. If the symbol represents a data constant, the symbol vector entry contains the actual value of the constant.

When you create the shareable image (by linking it specifying the /SHARE qualifier), the value of a universal symbol listed in the GST is the offset of its entry into the symbol vector (expressed as the offset *z* in Figure 8.2).

When you include this shareable image in a subsequent link operation, the linker puts this value in the linkage pair in the linkage section of the executable image that references the symbol. A linkage pair is a data structure defined by the *VSI OpenVMS Calling Standard*.

At run-time, when the image activator loads the shareable image into memory, it calculates the actual locations of the routines and relocatable data within the image and stores these values in the symbol vector. The image activator then fixes up the references to these symbols in the executable image that references symbols in the shareable image, moving the values from the symbol vector in the shareable image into the linkage section in the executable image. When the executable image makes the call to the procedure, shown as the Jump-to-Subroutine (JSR) instruction sequence in Figure 8.2, control is transferred directly to the location of the procedure within the shareable image.

Figure 8.2. Accessing Universal Symbols Specified Using the SYMBOL_VECTOR=Option

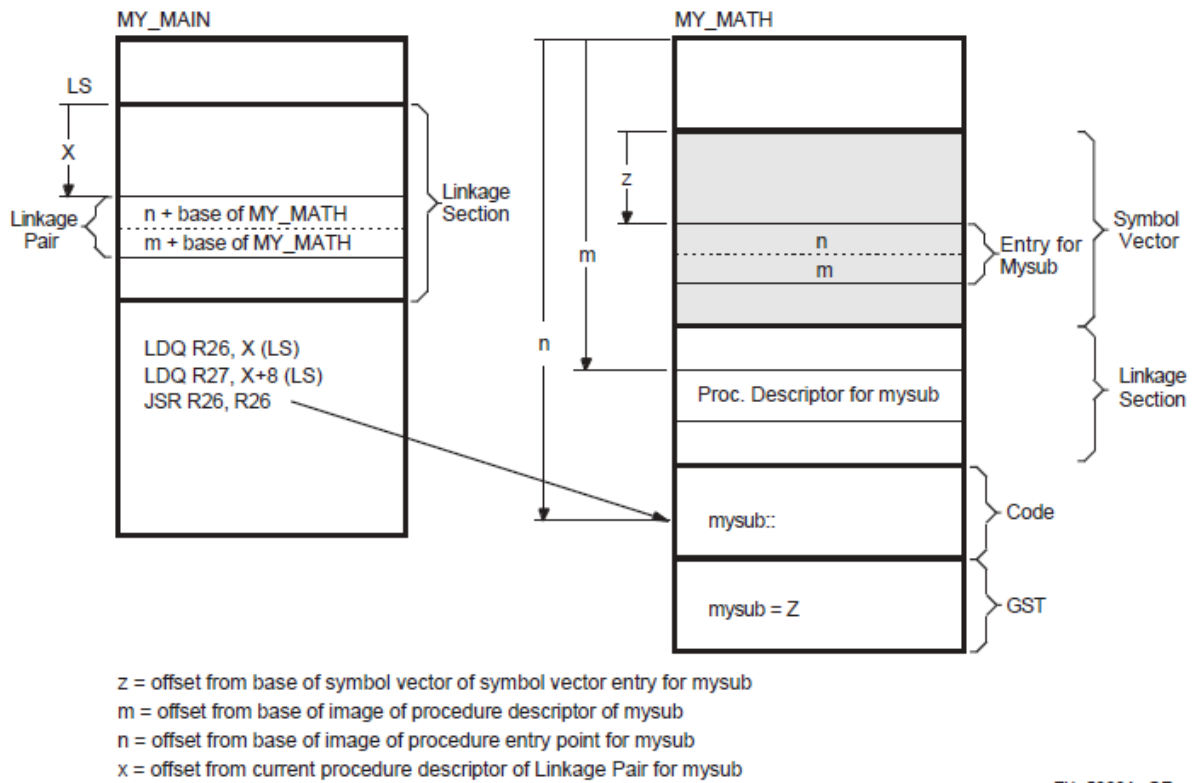

Note that, unlike VAX linking, global symbols implemented as overlaid program sections are not universal by default. Instead, you control which of these symbols is a universal symbol by including it in the `SYMBOL_VECTOR=option`, specifying the `PSECT` keyword. The example declares the program section `my_data` as a universal symbol.

You must specify the qualifier `/EXTERN_MODEL=COMMON` on the compile command line to make the VSI C for OpenVMS Alpha compiler implement the symbol as an overlaid program section. If you do not specify the `COMMON` keyword, the default keyword is `RELAXED_REFDEF`.

8.3.1. Symbol Definitions Point to Shareable Image Psects (Alpha Only)

On Alpha systems, the linker cannot overlay program sections that are referenced by symbol definitions with shareable image program sections of the same name. The C compiler generates symbol definition records that contain the index of an overlaid program section when the relaxed ref-def extern model is used (the default).

Shareable image program sections are created when you link a shareable image and use the `PSECT` keyword in your `SYMBOL_VECTOR` option.

If the linker detects this condition, it issues the following error:

```
%LINK-E-SHRSYMFND, shareable image psect <name> was pointed to
by a symbol definition
%LINK-E-NOIMGFIL, image file not created
```

The link continues, but no image is created. To work around this restriction, change the symbol vector keyword to `DATA`, or recompile your C program with the qualifier `/EXTERN=COMMON`.

For more information, see the VSI C for OpenVMS Alpha documentation.

The name of a symbol implemented as an overlaid program section can duplicate the name of a symbol representing a procedure or data location. If the program section specified in a `SYMBOL_VECTOR=` option does not exist, the linker issues a warning, places zeros in the symbol vector entry, and does not create an entry for the program section in the image's GST.

8.3.2. Creating Upwardly Compatible Shareable Images (Alpha Only)

The `SYMBOL_VECTOR=` option allows you to create upwardly compatible shareable images without requiring you to create transfer vectors as for VAX images.

However, as with transfer vectors, to ensure upward compatibility when using a `SYMBOL_VECTOR=` option, you must preserve the order and placement of the entries in the symbol vector with each relinking. Do not delete existing entries. Add new entries only at the end of the list. If you use multiple `SYMBOL_VECTOR=` option statements in a single options file to declare the universal symbols, you must also maintain the order of the `SYMBOL_VECTOR=` option statements in the options file. If you specify `SYMBOL_VECTOR=` options in separate options files, make sure the linker always processes the options files in the same order. (The linker creates only one symbol vector for an image).

Note, however, that there is no need to anchor the symbol vector at a particular location in memory, as you would anchor a transfer vector for a VAX link. The value at link time of a universal symbol in an Alpha shareable image is its location in the symbol vector, expressed as an offset from the base of the symbol vector, and the location of the symbol vector is stored in the image header. (For VAX linking, the value of a universal symbol at link time is the location of the symbol in the image, expressed as an offset from the base of the image). Thus, the relative position of the symbol vector within the image does not affect upward compatibility.

8.3.3. Deleting Universal Symbols Without Disturbing Upward Compatibility (Alpha Only)

To delete a universal symbol without disturbing the upward compatibility of an image, use the `PRIVATE_PROCEDURE` or `PRIVATE_DATA` keywords. In the following example, the symbol `mysub` is deleted using the `PRIVATE_PROCEDURE` keyword:

```
$ LINK/SHAREABLE MY_MATH, SYS$INPUT/OPT
GSMATCH=lequal,1,1000
SYMBOL_VECTOR=(myadd=PROCEDURE,-
mysub=PRIVATE_PROCEDURE,-
mymul=PROCEDURE,-
mydiv=PROCEDURE,-
my_symbol=DATA,-
my_data=PSECT)
Ctrl/Z
```

When you specify the `PRIVATE_PROCEDURE` or `PRIVATE_DATA` keyword in the `SYMBOL_VECTOR=` option, the linker creates symbol vector entries for the symbols *but does not create an entry for the symbol in the GST of the image*. The symbol still exists in the symbol vector and none of the other symbol vector entries have been disturbed. Images that were linked with previous versions of the shareable image that reference the symbol will still work, but the symbol will not be available for new images to link against.

Using the `PRIVATE_PROCEDURE` keyword, you can replace an entry for an obsolete procedure with a private entry for a procedure that returns a message that explains the status of the procedure.

8.3.4. Creating Run-Time Kits (Alpha Only)

If you use shareable images in your application, you may want to ship a run-time kit with versions of these shareable images that cannot be used in link operations.

To do this, you must first link your application, declaring the universal symbols in the shareable images using the `SYMBOL_VECTOR=` option so that references to these symbols can be resolved. After the application is linked, you must then relink the shareable images so that they have fully populated symbol vectors but empty global symbol tables (GSTs). The fully populated symbol vectors allow your application to continue to use the shareable image at run-time. The empty GSTs prevent other images from linking against your application.

To create this type of shareable image for a run-time kit (without having to disturb the `SYMBOL_VECTOR=` option statements in your application's options files), relink the shareable image after development is completed, specifying the `/NOGST` qualifier on the `LINK` command line. When you specify the `/NOGST` qualifier, the linker builds a complete symbol vector, containing the symbols you declared universal in the `SYMBOL_VECTOR=` option, but does not create entries for the symbols that you declared universal in the GST of the shareable image. For more information about the `/GST` qualifier, see Chapter 10.

8.3.5. Specifying an Alias Name for a Universal Symbol (Alpha Only)

For Alpha linking, a universal symbol can have a name, called a **universal alias**, different from the name contributed by the object module in which it is defined. You specify the universal alias name when you declare the global symbol as a universal symbol using the `SYMBOL_VECTOR=` option. The universal alias name precedes the internal name of the global symbol, separated by a slash (/). In the following example, the global symbol `mysub` is declared as a universal symbol under the name `sub_alias`.

```
LINK/SHAREABLE MY_SHARE/SYS$INPUT/OPT
SYMBOL_VECTOR=(myadd=procedure,-
               sub_alias/mysub=procedure,-
               mymul=procedure,-
               mydiv=procedure,-
               my_symbol=DATA,-
               my_data=PSECT)

Ctrl/Z
```

You can specify universal alias names for symbols that represent procedures or data; you cannot declare a universal alias name for a symbol implemented as an overlaid program section. In link operations in which the shareable image is included, the calling modules must refer to the universal symbol by its universal alias name to enable the linker to resolve the symbolic reference.

In a privileged shareable image, calls *from within the image* that use the alias name result in a fix-up and subsequent vectoring through the privileged library vector (PLV), which results in a mode change. Calls from within the shareable image that use the internal name are done in the caller's mode. (Calls from external images always result in a fix-up). For more information about creating a PLV, see the *VSI OpenVMS Programming Concepts Manual*.

8.3.6. Improving the Performance of Installed Shareable Images (Alpha Only)

For Alpha linking, you can improve the performance of an installed shareable image by installing it as a resident image (by using the `/RESIDENT` qualifier of the `INSTALL` utility). `INSTALL` moves the

executable, read-only pages of resident images into system space where they reside on huge pages. Executing your image in huge pages improves performance.

Chapter 9. Interpreting an Image Map File (Alpha and VAX)

This chapter describes how to interpret the information returned in an image map on OpenVMS Alpha and OpenVMS VAX systems and describes the combinations of linker qualifiers used to obtain a map.

For information about interpreting an image map file on OpenVMS x86-64 and OpenVMS I64 systems, see Chapter 5.

9.1. Overview of Alpha/VAX Linker Map

At your request, the linker can generate information that describes the contents of the image and the linking process itself. This information, called an **image map**, can be helpful when locating link-time errors, studying the layout of the image in virtual memory, and keeping track of global symbols.

You can obtain the following types of information about an image from its image map:

- The names of all modules included in the link operation, both explicitly in the LINK command and implicitly from libraries
- The names, sizes, and other information about the image sections that comprise the image
- The names, sizes, and locations of program sections within an image
- The names and values of all the global symbols referenced in the image, including the name of the module in which the symbol is defined and the names of the modules in which the symbol is referenced
- Statistical summary information about the image and the link operation itself

You determine which information the linker includes in a map file by specifying qualifiers in the LINK command line. If you specify the /MAP qualifier, the map file includes certain information by default (called the **default map**). You can also request a map file that contains less information about the image (called a **brief map**) or a map file that contains more information about the image (called a **full map**). Table 9.1 lists the LINK command qualifiers that affect map file production.

Table 9.1. LINK Command Map File Qualifiers

/MAP	Directs the linker to create a map file. This is the default for batch jobs. /NOMAP is the default for interactive link operations.
/BRIEF	When used in combination with the /MAP qualifier, directs the linker to create a map file that contains only a subset of all the possible information.
/FULL	When used in combination with the /MAP qualifier, directs the linker to create a map file that contains all the possible information.
/CROSS_REFERENCE	When used in combination with the /MAP qualifier, directs the linker to replace the Symbols By Name section with a Symbol Cross-Reference section, in which all the symbols in each module are listed with the modules in which they are called. You cannot request this type of listing in a brief map file.

9.2. Components of an Image Map File (Alpha/VAX)

The linker formats the information it includes in a map file into sections. Table 9.2 lists the sections of a map file in the order in which they appear in the file. The table also indicates whether the section appears in a brief map, full map, or default map file.

Table 9.2. Image Map Sections

Section Name	Description	Default Map	Full Map	Brief Map
Object Module Synopsis ¹	Lists all the object modules in the image.	Yes	Yes	Yes
Module Relocatable Reference Synopsis ²	Specifies the number of .ADDRESS directives in each module.	—	Yes	—
Image Section Synopsis	Lists all the image sections and clusters created by the linker.	—	Yes	—
Program Section Synopsis ¹	Lists the program sections and their attributes.	Yes	Yes	—
Symbols By Name ¹	Lists global symbol names and values.	Yes	Yes	—
Symbol Cross-Reference ¹	Lists each symbol name, its value, the name of the module that defined it, and the names of the modules that refer to it. Replaces the Symbols By Name section when the /CROSS_REFERENCE qualifier is specified.	Yes	Yes	—
Symbols By Value	Lists all the symbols with their values (in hexadecimal representation).	—	Yes	—
Image Synopsis	Presents statistics and other information about the output image.	Yes	Yes	Yes
Link Run Statistics	Presents statistics about the link run that created the image.	Yes	Yes	Yes

¹In a full map file, these sections include information about modules that were included in the link operation from libraries but were not explicitly specified on the LINK command line.

²VAX specific

The following sections describe each of the image map sections in detail. The examples of the map sections are taken from the map file created in a link operation of the executable image in Chapter 8.

9.2.1. Object Module Synopsis (Alpha/VAX)

The first section that appears in a map file is the Object Module Synopsis. This section lists the name of each module included in the link operation in the order in which it was processed. Note that shareable images included in the link operation are listed here as well. This section of the map file also includes other information about each module, arranged in columns, as in the following example:

```

+-----+
! Object Module Synopsis !
+-----+

Module Name ①  Ident ②  Bytes ③  File ④  Creation Date ⑤  Creator ⑥
-----
MY_MATH      V1.0      0  WORK:[PROGS]MY_MATH.EXE;11  3-NOV-2000 12:27  Linker T10-37
MY_MAIN     V1.0     553 WORK:[PROGS]MY_MAIN.OBJ;15  3-NOV-2000 12:27  C X1.1-048E
DECC$SHR    V1.0      0  [SYSLIB]DECC$SHR.EXE;2  9-JUL-2000 07:49  Linker T10-03
SYS$PUBLIC_VECTORS
X-26      0  [SYSLIB]SYS$PUBLIC_VECTORS.EXE;2  9-JUL-2000 07:34  Linker T10-03

```

- ① **Module Name.** The name of each object module included in the link operation. The modules are listed in the order in which the linker processed them. If the linker encounters an error during its processing of an object module, an error message appears on the line directly following the line containing the name of that object module.
- ② **Ident.** The text string in the IDENT field in an object module or in the image header of a shareable image.
- ③ **Bytes.** The number of bytes the object module contributes to the image. Because shareable images are activated at run-time, the linker cannot calculate the size of their contributions to the image. Thus, the value 0 (zero) is associated with shareable images.
- ④ **File.** Full file specification of the input file, including device and directory. If the specification is longer than 35 characters, it is shortened by dropping the device portion of the file specification or both the device and directory portions of the file specification.
- ⑤ **Creation Date.** The date and time the file was created.
- ⑥ **Creator.** Identification of the language processor or other utility that created the file.

The order in which the modules are listed in this section reflects the order in which the linker processes the input files specified in the link operation. Note that the order of processing can be different from the order in which the files were specified in the command line. For more information about how the linker processes input files, see Chapter 6.

9.2.2. Module Relocatable Reference Synopsis (VAX Only)

For VAX linking, the information contained in the Module Relocatable Reference Synopsis section varies with the type of image being created. For shareable images, this section lists all of the modules that contain at least one .ADDRESS directive. For executable or system images, this section lists the names of all object modules containing at least one .ADDRESS reference *to a shareable image*. The section lists the modules in the order in which the linker processes them, including the number of .ADDRESS references found. The linker formats the information as in the following example:

```

+-----+
! Module Relocatable Reference Synopsis !
+-----+

Module Name ①      Number ②  Module Name      Number  Module Name      Number
-----
MAIN1            1

```

- ❶ Module Name. The name of each object module included in the link operation. The modules are listed in the order in which the linker processed them.
- ❷ Number. The number of .ADDRESS references found.

Note that you can reduce linker and image activator processing time by removing .ADDRESS directives from input files.

9.2.3. Image Section Synopsis Section (Alpha/VAX)

The Image Section Synopsis section of the linker map file lists the image sections created by the linker. The image sections appear in the order in which the linker created them, which is the same order as the clusters in the linker's cluster list. (For more information about clusters, see Chapter 6). The section includes other information about these image sections, formatted in columns, as in the following example:

```

+++++
! Image Section Synopsis !
+++++

❶ ❷ ❸ ❹ ❺ ❻ ❼ ❽ ❾ ❿ ⓫
Cluster Type Pglts Base Addr Disk VBN PFC Protection and Paging Global Sec. Name Match Majorid Minorid
-----
MY_MATH      2 1 00000000R 0 0 READ WRITE COPY ON REF MY_MATH_001 EQUAL 113 5598831
              2 1 00010000R 0 0 READ WRITE COPY ON REF MY_MATH_002 EQUAL 113 5598831
              3 1 00020000R 0 0 READ ONLY MY_MATH_003 EQUAL 113 5598831
              4 1 00030000R 0 0 READ WRITE COPY ON REF MY_MATH_004 EQUAL 113 5598831
              2 1 00040000R 0 0 READ WRITE FIXUP VECTORS MY_MATH_005 EQUAL 113 5598831

DEFAULT_CLUSTER 0 1 00010000 3 0 READ WRITE NONSHAREABLE ADDRESS DATA
                0 1 00020000 4 0 READ ONLY
                0 1 00030000 5 0 READ WRITE FIXUP VECTORS
                253 20 7FFF0000 0 0 READ WRITE DEMAND ZERO

DECC$SHR      2 132 00000000-R 0 0 READ WRITE COPY ON REF DECC$SHR_001 LESS/EQUAL 1 0
              2 4 00020000-R 0 0 READ WRITE COPY ON REF DECC$SHR_002 LESS/EQUAL 1 0
              3 11 00030000-R 0 0 READ ONLY DECC$SHR_003 LESS/EQUAL 1 0
              3 965 00040000-R 0 0 READ ONLY DECC$SHR_004 LESS/EQUAL 1 0
              4 7 000C0000-R 0 0 READ WRITE COPY ON REF DECC$SHR_005 LESS/EQUAL 1 0
              4 71 000D0000-R 0 0 READ WRITE COPY ON REF DECC$SHR_006 LESS/EQUAL 1 0
              4 1 P-000E0000-R 0 0 READ WRITE COPY ON REF DECC$SHR_007 LESS/EQUAL 1 0
              2 9 000F0000-R 0 0 READ WRITE FIXUP VECTORS DECC$SHR_008 LESS/EQUAL 1 0

SYS$PUBLIC_VECTORS
              2 15 00000000-R 0 0 READ ONLY SYS$PUBLIC_VECTO EQUAL 113 14651409
              1 24 00004000-R 0 0 READ WRITE COPY ON REF SYS$PUBLIC_VECTO EQUAL 113 14651409
              2 1 00008000-R 0 0 READ WRITE FIXUP VECTORS SYS$PUBLIC_VECTO EQUAL 113 14651409

Key for special characters above:
+++++
! R Relocatable !
! P Protected !
+++++

```

1. Cluster. The name of each cluster the linker created, listed in the order in which the linker created them.
2. Type. The type of image section, expressed as one of the following codes:

Code	Image Section Type
1	Shareable fixed image section
2	Private fixed image section
3	Shareable position-independent image section
4	Private position-independent image section
253	Stack image section

For more information about the types of image sections the linker creates, see Section 7.3.5.

3. Pages or pagelets. The length of each image section, expressed in pages or pagelets.

4. **Base Address.** The base address assigned to the image section. Note that if the cluster is relocatable, the image activator relocates the base address. In this case, the base address entry for each image section in the cluster MY_MATH has the letter “R” appended to it, indicating that the base address entry is an offset to be added to the cluster base address assigned by the image activator.

For Alpha linking, when images are installed as resident images, the Install utility moves image sections containing code into system space. This invalidates the base addresses listed for these image sections in this section of the map file. Note, however, that the relative positions of the program sections within the image section, listed in the Program Section Synopsis section of the map file, remain valid when the image section is moved into system space.

5. **Disk VBN (virtual block number).** The virtual block number of the image file on disk where the image section begins. The number 0 indicates that the image section is not in the image file.
6. **Page fault cluster (PFC).** The number of pagelets read into memory by the operating system when the initial page fault occurs for that image section. The number 0 indicates that the system parameter PFCDEFAULT determines this value, rather than the linker.
7. **Protection and Paging.** A keyword phrase that characterizes the settings of certain attributes of the image section, such as the attributes that affect protection and paging. The following table lists the keywords used by the linker to indicate these characteristics of an image section:

Keyword	Meaning
COPY ON REF	Indicates that the image section is a copy-on-reference image section. Because a copy-on-reference image section is readable and writable, but not shareable, each process receives a copy of it.
DEMAND ZERO	Indicates that the image section is a demand-zero image section. For more information, see Section 7.4.3.
EXECUTABLE	Indicates that the image section contains code.
FIXUP VECTORS	Indicates that the image section contains the fix-up section. There is always a change-protection fix-up for the fix-up section, so that when the image activator is done, the image activator changes the protection of the image section to READ ONLY.
NON-SHAREABLE ADDRESS DATA	Indicates that the linker set a READONLY page in the image section to WRITE so that the image activator can fix up address references (.ADDRESS) in the image section. The linker creates a change-protection fix-up for these image sections that causes the image activator to set the attributes of the image section back to READ ONLY when it finishes processing the address references.
READ ONLY	Indicates that the image section is protected against write access.
READ WRITE	Indicates that the image section allows both read and write access.

The linker may use more than one keyword to describe an image section. For example, to describe an image section that contains code, the linker uses the READ ONLY and EXECUTABLE keywords.

Note that a program section that you may have protected from write access (by setting the NOWRT program section attribute) may appear in the map file as writable (with the READ WRITE keyword). If this program section also has the NON-SHAREABLE ADDRESS DATA keyword (as the first image section in DEFAULT_CLUSTER illustrates), the linker has enabled write access to the program section to allow the image activator to fix up address references in the image section at run-time. The image activator resets the program section attributes to READ ONLY after it is finished.

8. Global Section Name. The name assigned by the linker to each image section comprising a shareable image. The linker creates the names by appending the characters “_00x” after the file name, where “x” is an integer, starting with 1, and incremented for each image section in a shareable image.
9. Match. The algorithm the image activator uses when comparing identification numbers in a shareable image, expressed by the keyword LESS/EQUAL, EQUAL, or ALWAYS. For more information about this topic, see the description of the GSMATCH= option in Chapter 10.
10. Majorid. An identification number assigned to the image. The linker assigns the number to the image if it is not specified as part of the link operation in the GSMATCH= option.
11. Minorid. An identification number assigned to the image. The linker assigns the number to the image if it is not specified as part of the link operation in the GSMATCH= option.

9.2.4. Program Section Synopsis Section (Alpha/VAX)

The Program Section Synopsis section lists the program sections that comprise the image, with information about the size of the program section, its starting- and ending-addresses, and its attributes. The Module Name column in this section lists the modules that contribute to each program section. The following example illustrates this format:

Psect Name ¹	Module Name ²	Base ³	End ⁴	Length ⁵	Align ⁶	Attributes ⁷	
\$LINK\$	MY_MAIN	00010000	000100BF	000000C0 (192.)	OCTA 4	NOPIC, CON, REL, LCL, NOSHR, NOEXE, NOWRT, NOVBC, MOD
		00010000	000100BF	000000C0 (192.)	OCTA 4	
MY_DATA	MY_MAIN	00010010	00010013	00000004 (4.)	OCTA 4	NOPIC, OVR, REL, GBL, NOSHR, NOEXE, WRT, NOVBC, MOD
	MY_MAIN	00010010	00010010	00000000 (0.)	OCTA 4	
	MY_MAIN	00010010	00010013	00000004 (4.)	OCTA 4	
\$LITERAL\$	MY_MAIN	000100C0	00010108	00000049 (73.)	OCTA 4	PIC, CON, REL, LCL, SHR, NOEXE, NOWRT, NOVBC, MOD
		000100C0	00010108	00000049 (73.)	OCTA 4	
\$READONLY\$	MY_MAIN	00010110	00010110	00000000 (0.)	OCTA 4	NOPIC, CON, REL, LCL, NOSHR, NOEXE, NOWRT, NOVBC, MOD
		00010110	00010110	00000000 (0.)	OCTA 4	
\$BSS\$	MY_MAIN	00020000	00020000	00000000 (0.)	OCTA 4	NOPIC, CON, REL, LCL, NOSHR, NOEXE, WRT, NOVBC, MOD
		00020000	00020000	00000000 (0.)	OCTA 4	
\$DATA\$	MY_MAIN	00020000	00020000	00000000 (0.)	OCTA 4	NOPIC, CON, REL, LCL, NOSHR, NOEXE, WRT, NOVBC, MOD
		00020000	00020000	00000000 (0.)	OCTA 4	
\$CODE\$	MY_MAIN	00020000	0002011B	0000011C (284.)	OCTA 4	PIC, CON, REL, LCL, SHR, EXE, NOWRT, NOVBC, MOD
		00020000	0002011B	0000011C (284.)	OCTA 4	

VM-0319A-AI

1. Psect Name. The name of each program section in the image in ascending order of its base virtual address.
2. Module Name. The names of the modules that contribute to the program section whose name appears on the line directly above in the Psect Name column. If a shareable image appears in this column, the linker processed the program section as a shareable image reference.
3. Base. The starting virtual address of the program section or of a module that contributes to a program section.

4. End. The ending virtual address of the program section or of a module that contributes to a program section.
5. Length. The total length of the program section or of a module that contributes to a program section.
6. Align. The type of alignment used for the entire program section or for an individual program section contribution. The alignment is expressed in two ways. In the first column, the alignment is expressed using a predefined keyword, such as OCTA. In the second column, the alignment is expressed as an integer that is the power of 2 that creates the alignment. For example, octaword alignment would be expressed as the keyword OCTA and as the integer 4 (because $2^4 = 16$).

If the linker does not support a keyword to express an alignment, it puts the text "2 **" in the column in which the keyword usually appears. When read with the integer in the second column, it expresses these alignments, such as 2^{**5} .

7. Attributes. The attributes associated with the program section. For a list of all the possible attributes, see Chapter 7.

For Alpha linking, the linker includes the MOD attribute in the list of program section attributes (as illustrated in the example). To make room in the display for this attribute, the linker leaves out the Readability (RD/NORD) and User Library (USR/LIB) attributes, which are reserved for future use.

For VAX linking, the list of attributes includes the Readability (RD/NORD) and User Library (USR/LIB) attributes. The Modified (MOD/NOMOD) attribute, which is not supported for VAX images, is not included.

Note that, if a routine is extracted from the default system library to resolve a symbolic reference, the Program Section Synopsis section in a full map contains information about the program sections comprising that routine. The Program Section Synopsis section in a default map does not.

9.2.5. Symbols By Name Section (Alpha/VAX)

The Symbols By Name section lists the global symbols contained in all the modules included in the link operation. The section includes the value of the symbol, in the following format:

```

+-----+
! Symbols By Name !
+-----+

Symbol ❶      Value ❷  Symbol      Value      Symbol      Value      Symbol      Value
-----
DECC$EXIT      00001FD0-RX
DECC$GPRINTF   00001710-RX
DECC$MAIN      000007D0-RX
MAIN           00010000-R
MYSUB          00000010-RX
MY_SYMBOL      00000050-RX
SYS$IMGSTA     00000340-RX
__MAIN        00010078-R

```

- ❶ Symbol. The names of the image's global symbols in alphabetical order.
- ❷ Value. The value of the symbol, expressed in hexadecimal. The linker appends characters to the end of the symbol value to describe other characteristics of the symbol. For an explanation of these symbols, see Section 9.2.7.

Note that this section is replaced by the Symbol Cross-Reference section when you specify the `/CROSS_REFERENCE` qualifier in the `LINK` command. The Symbols by Value section, described in Section 9.2.7, lists the same symbols by value.

9.2.6. Symbol Cross-Reference Section (Alpha/VAX)

The Symbol Cross-Reference Section, which is produced in place of the Symbols By Name section when you specify the `/CROSS_REFERENCE` qualifier, lists all of the symbols referenced in the image, along with the module in which they are defined and with all the modules that reference them. The section formats this information as in the following example:

```

+-----+
! Symbol Cross Reference !
+-----+

Symbol ❶      Value ❷      Defined By ❸      Referenced By ... ❹
-----
DECC$EXIT    00001FD0-RX      DECC$SHR          MY_MAIN
DECC$GPRINTF 00001710-RX      DECC$SHR          MY_MAIN
DECC$MAIN    000007D0-RX      DECC$SHR          MY_MAIN
MAIN         00010000-R       MY_MAIN
MYSUB       00000010-RX      MY_MATH           MY_MAIN
MY_SYMBOL   00000050-RX      MY_MATH           MY_MAIN
SYS$IMGSTA  00000340-RX      SYS$PUBLIC_VECTORS
__MAIN     00010078-R       MY_MAIN

```

- ❶ Symbol. The name of the global symbol.
- ❷ Value. The value of the global symbol, expressed in hexadecimal. The linker appends characters to the end of the symbol value to describe other characteristics of the symbol. For an explanation of these symbols, see Section 9.2.7.
- ❸ Defined By. The name of the module in which the symbol is defined. For example, the symbol `mysub` is defined in the module named `MY_MATH`.
- ❹ Referenced By.... The name or names of all the modules that contain at least one reference to the symbol.

9.2.7. Symbols By Value Section (Alpha/VAX)

The Symbols By Value section lists all the global symbols in the image

The Symbols By Value section lists all the global symbols in the image in order by value, in ascending numeric order. The linker formats the information into columns, as in the following example:

```

+-----+
! Symbols By Value !
+-----+

Value ❶      Symbols... ❷
-----
00000010    RX-MYSUB
00000050    RX-MY_SYMBOL
00000340    RX-SYS$IMGSTA
000007D0    RX-DECC$MAIN
00001710    RX-DECC$GPRINTF
00001FD0    RX-DECC$EXIT
00010000    R-MAIN
00010078    R-__MAIN

```

- ❶ Value. The value of each global symbol, expressed in hexadecimal, in ascending numerical order.
- ❷ Symbols... The names of the global symbols. If more than one symbol has the same value, the linker lists them on more than one line. The characters prefixed to the symbol names indicate other characteristics of the symbol, such as its scope. Table 9.3 lists these codes.

Table 9.3. Symbol Characterization Codes (Alpha/VAX)

Code	Meaning
asterisk(*)	Symbol is undefined.
A ¹	Symbol is the alias name for a universal symbol.
I ¹	Symbol is the internal name of a symbol that has a universal alias name.
U	Symbol is a universal symbol.
R	Symbol is a relocatable symbol.
X	Symbol is an external symbol.
WK	Symbol is a weak symbol. (For more information, see Chapter 6).

¹Alpha specific

9.2.8. Image Synopsis Section (Alpha/VAX)

The Image Synopsis section contains miscellaneous information about the image, such as its name and identification numbers, and a summary of various attributes of the image, such as the number of files used to build the image. The following example illustrates the format of this section of a map file. The list following the example provides more information about items in this section that are not self-explanatory.

```

+-----+
! Image Synopsis !
+-----+

Virtual memory allocated:❶      00010000 0003FFFF 00030000 (196608. bytes, 384. pages)
Stack size:                    20. pages
Image header virtual block limits:      1.      2. (  2. blocks)
Image binary virtual block limits:     3.      5. (  3. blocks)
Image name and identification:          MY_MAIN V1.0
Number of files:                      7.
Number of modules:                     4.
Number of program sections:            11.
Number of global symbols:              944.
Number of cross references:             13.
Number of image sections:              20.
User transfer address:                 00010078
Debugger transfer address:             00000340
Number of code references to shareable images: 6.
Image type:                           EXECUTABLE.
Map format:                            FULL WITH CROSS REFERENCE in file WORK:[PROGS]MY_MAIN.MAP:15
Estimated map length:                  148. blocks

```

❶ Virtual memory allocated. This line contains the following information:

- The starting-address of the image (base-address)
- The ending-address of the image
- The total size of the image, expressed in bytes, in hexadecimal radix

The numbers in parentheses at the end of the line indicate the total size of the image, expressed in bytes and in pagelets. Both these values are expressed in decimal.

9.2.9. Link Run Statistics Section (Alpha/VAX)

The Link Run Statistics section contains miscellaneous statistical information about the link operation, such as performance indicators, formatted as in the following example:

+-----+
! Link Run Statistics !
+-----+

Performance Indicators	Page Faults	CPU Time	Elapsed Time
-----	-----	-----	-----
Command processing:	93	00:00:00.18	00:00:00.81
Pass 1:	345	00:00:00.55	00:00:12.04
Allocation/Relocation:	9	00:00:00.04	00:00:00.30
Pass 2:	29	00:00:00.14	00:00:00.62
Map data after object module synopsis:	3	00:00:00.05	00:00:00.31
Symbol table output:	0	00:00:00.00	00:00:00.10
Total run values:	479	00:00:00.96	00:00:14.18

Using a working set limited to 2048 pages and 946 pages of data storage (excluding image)

Total number object records read (both passes): 167
of which 0 were in libraries and 0 were DEBUG data records containing 0 bytes

Number of modules extracted explicitly = 0
with 0 extracted to resolve undefined symbols

5 library searches were for symbols not in the library searched

A total of 0 global symbol table records was written

LINK/MAP/FULL/CROSS MY_MAIN,SYS\$INPUT/OPT
my_math/share

Chapter 10. LINK Command Reference

10.1. LINK Command

LINK

LINK — Invokes the OpenVMS Linker utility to link one or more input files into a program image and defines the execution characteristics of the image.

Format

LINK file-spec [,...]

Qualifiers	Supported Platform	Defaults
/ALPHA	Alpha, VAX	Platform dependent, see reference description.
/BASE_ADDRESS[=address]	x86-64, I64	/NOBASE_ADDRESS
/BPAGE[=page-size-indicator]	All	Platform dependent, see reference description.
/BRIEF	All	None.
/CONTIGUOUS	All	/NOCONTIGUOUS
/CROSS_REFERENCE	All	None.
/DEBUG[=file-spec]	All	/NODEBUG
/DEMAND_ZERO[=PER_PAGE]	64-bit platforms	/DEMAND_ZERO
/DNI (Display Name Information)	x86-64, I64	/DNI
/DSF[=file-spec] (Debug Symbol File)	64-bit platforms	/NODSF
/EXECUTABLE[=file-spec]	All	/EXECUTABLE
/FP_MODE=keyword	x86-64, I64	/NOFP_MODE
/FULL[=(keyword[,...])]	All	None.
/GST (Global Symbol Table)	64-bit platforms	/GST
/HEADER	Alpha, VAX	/NOHEADER ¹
/INCLUDE=(module-name[,...])	All	None.
/INFORMATIONALS	All	/INFORMATIONALS
/LIBRARY	All	None.
/MAP[=file-spec]	All	/NOMAP (in interactive mode)
/NATIVE_ONLY	I64, Alpha	/NATIVE_ONLY

Qualifiers	Supported Platform	Defaults
/OPTIONS	All	None.
/P0IMAGE	All	/NOP0IMAGE
/PROTECT	All	/NOPROTECT
/REPLACE	Alpha	/REPLACE ¹
/SECTION_BINDING[=(CODE,DATA)]	Alpha	/NOSECTION_BINDING ¹
/SEGMENT_ATTRIBUTE=(segm-attribute, [...])	x86-64, I64	None.
/SELECTIVE_SEARCH	All	None.
/SHAREABLE[=file-spec]	All	/NOSHAREABLE
/SYMBOL_TABLE[=file-spec]	All	/NOSYMBOL_TABLE
/SYSEXE	64-bit platforms	/NOSYSEXE
/SYSLIB	All	/SYSLIB
/SYSSHR	All	/SYSSHR
/SYSTEM[=base-address]	Alpha, VAX	/NOSYSTEM
/THREADS_ENABLE	All	/NOTHREADS_ENABLE
/TRACE	All	/TRACE
/USERLIBRARY[=(table[,...])]	All	/USERLIBRARY=ALL
/VAX	Alpha, VAX	Platform dependent, see reference description.

¹On x86-64 and I64 systems, the qualifier is accepted by the linker but has no effect.

Parameters

file-spec [, ...]

Specifies one or more input files (wildcard characters are not allowed). Input files may be object modules, shareable images, libraries to be searched for external references or from which specific modules are to be included, or options files to be read by the linker. Separate multiple input file specifications with commas (,) or plus signs (+). In either case, the linker creates a single image file.

If you omit the file type in an input file specification, the linker supplies default file types, based on the nature of the input file. For object modules, the default file type is .OBJ. For more information about specifying input files, see Chapter 1.

10.2. Qualifier Descriptions

This section describes the LINK command qualifiers.

/ALPHA (Alpha and VAX)

/ALPHA (Alpha and VAX) — Directs the linker to produce an OpenVMS Alpha image. On OpenVMS Alpha or VAX systems, when neither /ALPHA nor /VAX is specified, the default action is to create an OpenVMS VAX image on an OpenVMS VAX system and to create an OpenVMS Alpha image on an OpenVMS Alpha system.

Format

```
/ALPHA
```

Description

This qualifier is used to instruct the linker to accept OpenVMS Alpha object files and library files to produce an OpenVMS Alpha image.

You must inform the linker where OpenVMS Alpha system libraries and shareable images are located with the logical names ALPHA\$LOADABLE_IMAGES and ALPHA\$LIBRARY. On an OpenVMS Alpha system, these logicals are already defined to point to the correct directories on the current system disk. On OpenVMS VAX, you must define these logical names so that they translate to the location of an OpenVMS Alpha system disk residing on the system where the Alpha linking is to occur.

For more information on cross-architecture linking, see Section 1.5.

Example

```
$ DEFINE ALPHA$LIBRARY DKB100:[VMS$COMMON.SYSLIB]
$ DEFINE ALPHA$LOADABLE_IMAGES DKB100:[VMS$COMMON.SYS$LDR]
$ LINK/ALPHA ALPHA.OBJ
```

This example, which is performed on an OpenVMS VAX system, shows the definition of logical names to point to the appropriate a reason an OpenVMS Alpha system disk mounted on device DKB100. The qualifier /ALPHA tells the linker to expect the object file,ALPHA.OBJ, to be an OpenVMS Alpha object file and to link it using the OpenVMS Alpha libraries and images on DKB100, if necessary.

/BASE_ADDRESS (x86-64 and I64)

/BASE_ADDRESS (x86-64 and I64) — Assigns a virtual address for executable images that are not activated by the OpenVMS image activator, such as images used in the boot process.

Format

```
/BASE_ADDRESS=address
```

```
/NOBASE_ADDRESS (default)
```

Qualifier Values

address

The location at which you want the first segment of the executable image located. You can express this location as decimal (%D), octal (%O), or hexadecimal (%X) numbers. The default is hexadecimal.

Description

The /BASE_ADDRESS qualifier assigns a virtual address for executable images that are not activated by the OpenVMS image activator, such as images used in the boot process. The base address is the

starting address that you want the linker to assign to an executable image. The OpenVMS image activator is free to ignore any linker-assigned starting address. This qualifier is used primarily by system developers.

The `/BASE_ADDRESS` qualifier does not replace the `BASE=` option or the base-address specifier in the `CLUSTER=` option, which is illegal on OpenVMS x86-64 and I64 systems.

For all images (executable and shareable), the starting address is determined by the image activator. Any linker assigned address value can be changed when activating the image.

/BPAGE

`/BPAGE` — Specifies the page size the linker should use when it creates the segments (on x86-64 and I64 systems) or image sections (on Alpha and VAX systems) that make up an image.

Format

`/BPAGE[=page-size-indicator]`

Qualifier Values

`page-size-indicator`

An integer that specifies a page size as the power of 2 required to create a page that size. For example, to get an 8 KB page size, specify the value 13 because 2^{13} equals 8 K. The following table lists the page sizes supported by the linker with the defaults:

Value	Page Size	Defaults
9	512 bytes	Default value for VAX links when the <code>/BPAGE</code> qualifier is not specified.
13	8 KB	Default value for VAX links when the <code>/BPAGE</code> qualifier is specified without a value.
14	16 KB	—
15	32 KB	—
16	64 KB	Default value on 64-bit systems when <code>/BPAGE</code> is not specified or when the <code>/BPAGE</code> qualifier is specified without a value.

Description

The images the linker creates are made up of segments (on x86-64 and I64 systems) or image sections (on Alpha and VAX systems) that the linker allocates on page boundaries. When you specify a larger pagesize, the origin of segments or image sections increases to the next multiple of that size.

An image linked to a page size that is larger than the page size of the CPU generally runs correctly, but it might consume more virtual address space.

On 64-bit systems, by default the linker creates segments or image sections on 64 KB boundaries, thus allowing the images to run properly on any 64-bit system, regardless of the hardware page size.

On VAX systems, linking a shareable image to a larger page size can cause the value of transfer vector offsets to change if they were not allocated in page 0 of the image. Do not link against as hareable

image that was created with a different page size. (You cannot determine the page size used in the creation of a VAX image from the image).

Example

```
$ LINK/BPAGE=16 MY_PROG.OBJ
```

Including the value 16 with the /BPAGE qualifier causes the linker to create segments (on x86-64 and I64 systems) or image sections (on Alpha and VAX systems) on 64 KB page boundaries.

/BRIEF

/BRIEF — Directs the linker to produce a brief image map. For more information, see also the /MAP and /FULL qualifiers.

Format

```
/MAP/BRIEF
```

Qualifier Values

None.

Description

On x86-64 and I64 systems, a brief map contains the following sections:

- Object and Image Synopsis
- Image Segment Synopsis
- Link Run Statistics

On Alpha and VAX systems, a brief map contains the following sections:

- Object Module Synopsis
- Image Section Synopsis
- Link Run Statistics

In contrast, on x86-64 and I64 systems, the default image map contains the Object and Image Synopsis, Image Synopsis, Link Run Statistics, Program Section Synopsis, and Symbols By Name sections. On Alpha and VAX systems, the default image map contains the Object Module Synopsis, Image Synopsis, Link Run Statistics, Program Section Synopsis, and Symbols By Name sections. For more information about image maps, see Chapter 5 (x86-64 and I64) and Chapter 9 (Alpha and VAX).

The /BRIEF qualifier must be specified with the /MAP qualifier and is incompatible with the /FULL qualifier and the /CROSS_REFERENCE qualifier.

Example

```
$ LINK/MAP/BRIEF MY_PROG
```

In this example, the linker creates a brief image map with the filename MY_PROG.MAP.

/CONTIGUOUS

`/CONTIGUOUS` — Directs the linker to place the entire image in consecutive disk blocks. If sufficient contiguous space is not available on the output disk, the linker reports an error and terminates the link operation.

Format

`/CONTIGUOUS`

`/NOCONTIGUOUS` (default)

Description

You can use the `/CONTIGUOUS` qualifier to speed up the activation time of any type of image because images usually activate more slowly if their image disk blocks are not contiguous. Note, however, that in most cases performance benefits do not warrant the use of the `/CONTIGUOUS` qualifier.

You can also use the `/CONTIGUOUS` qualifier when linking bootstrap programs for certain system images that require contiguity.

Even when you do not specify the `/CONTIGUOUS` qualifier, the file system tries to use contiguous disk blocks for images, if sufficient contiguous space is available.

Example

```
$ LINK/CONTIGUOUS MY_PROG
```

This example directs the linker to place the entire image named `MY_PROG.EXE` in consecutive disk blocks.

/CROSS_REFERENCE

`/CROSS_REFERENCE` — Directs the linker to replace the Symbols By Name section in a full or default image map with the Symbol Cross-Reference section.

Format

`/MAP/CROSS_REFERENCE`

Description

The Symbol Cross-Reference section lists, in alphabetical order, the name of each global symbol, together with the following information about each:

- Its value
- The name of the first module in which it is defined
- The name of each module in which it is referenced

The number of symbols listed in the cross-reference section depends on whether the linker generates a full map or a default map. In a full map, this section includes global symbols from all modules in the image, including those extracted from all libraries. In a default map, this section does not include

global symbols from modules extracted from the default system libraries IMAGELIB.OLB and STARLET.OLB. For more information about image map files, see Chapter 5 (x86-64 and I64) and Chapter 9 (Alpha and VAX).

The `/CROSS_REFERENCE` qualifier is incompatible with the `/BRIEF` qualifier.

Example

```
$ LINK/MAP/CROSS_REFERENCE MY_PROG
```

This example produces an image map file named `MY_PROG.MAP` that includes a Symbol Cross-Reference section.

/DEBUG

`/DEBUG` — Directs the linker to generate debug and traceback information and to give the debugger control when the image is run.

Format

```
/DEBUG[=file-spec]
```

```
/NODEBUG (default)
```

Qualifier Values

file-spec (Alpha and VAX)

Identifies a user-written debugger module.

If you specify the `/DEBUG` qualifier without entering a file specification, the OpenVMS Debugger gains control at run-time. Requesting the OpenVMS Debugger does not affect the location of code within the image because the debugger is mapped into the process address space at run-time, not at link time. See the *VSI OpenVMS Debugger Manual* for additional information.

On x86-64 and I64 systems, a file specification is not allowed.

On Alpha and VAX systems, if you specify the `/DEBUG` qualifier with a file specification, the user-written debugger module that the file specification identifies gains control at run-time. The linker assumes a default file type of `.OBJ`. Requesting a user-written debugger module does affect the location of code within the image.

Description

The `/DEBUG` qualifier automatically includes the `/TRACE` qualifier. If you specify the `/DEBUG` qualifier and the `/NOTRACE` qualifier, the linker overrides your specification and includes traceback information.

To debug a shareable image, you must compile and link it with the `/DEBUG` qualifier and then include it in a link operation that creates a debuggable image (that link operation must also use the `/DEBUG` qualifier).

For x86-64 and I64 systems, Table 3.10 indicates where global symbol definitions are written during a link operation that uses the debug related qualifiers as `/DEBUG`, `/DSF`, or `/TRACE`. Table 3.9 shows how these qualifiers determine the link flags in the generated image.

On 64-bit systems, Table 10.1 shows the effects of debug-related qualifiers when running an image.

Table 10.1. Effects of /DEBUG, /DSF and /TRACE when Running an Image on 64-Bit Systems

	RUN	RUN/ DEBUG	RUN/NODEBUG	Traceback Info	Debug Info
/NoTrace /NoDebug /NoDSF	Start main	Same as RUN	Same as RUN	None	None
/Trace /NoDebug /NoDSF	Enable traceback handler; start main	Set initial breakpoint; start debugger	Same as RUN	Automatic: in image	None
/NoTrace /Debug /NoDSF	The linker converts /NoTrace to /Trace: see next row				
/Trace /Debug /NoDSF	Set initial breakpoint; start debugger	Same as RUN	Enable traceback handler; start main	Automatic: in image	Automatic: in image
/NoTrace /NoDebug /DSF	Start main	Same as RUN	Same as RUN	Not used	Not used
/Trace /NoDebug /DSF	Enable traceback handler; start main	Set initial breakpoint; start debugger	Same as RUN	Automatic: in image ¹	Manual: in DSF
/NoTrace /Debug /DSF	The linker converts /NoTrace to /Trace: see next row				
/Trace /Debug /DSF	Set initial breakpoint; start debugger	Same as RUN	Enable traceback handler; start main	Automatic: in image ¹	Manual: in DSF

¹x86-64 and I64 specific. On Alpha systems, the traceback info is in the DSF file; for a RUN, the traceback handler is enabled but it cannot print the line information, because it is not in the image.

Additional information:

- The VAX linker does not generate a DSF file. For VAX, a reduced table with /NoDSF lines applies.
- Start main — Execution starts at the main entry of the image
- None — No traceback or debug information is generated by the linker
- Enable traceback handler — In case of an error, a traceback with source line information is printed. if there is no handler, in case of an error, a register dump is printed.
- Set initial breakpoint — Depending on the programming language, the initial breakpoint may be at main or before main
- Start debugger — The debugger controls the execution of the image

- Not used — There is traceback or debug information in the image or DSF file, however it is not used.
- Automatic — Automatically found by the debugger.
- Manual — Automatically found by the debugger if the DSF is in the same directory as the image. Manually points to a different directory of the DSF file with the logical `DBG$IMAGE_DSF_PATH`.

Example

```
$ LINK/DEBUG MY_PROG
```

This example produces an executable image named `MY_PROG.EXE`. Upon image activation, control will be passed to the debugger.

/DEMAND_ZERO (64-Bit Systems)

`/DEMAND_ZERO (64-Bit Systems)` — Enables demand-zero segment (on x86-64 and I64 systems) or image section (on Alpha systems) production for both executable and shareable images.

Format

```
/DEMAND_ZERO (default)
```

```
/DEMAND_ZERO[ =PER_PAGE ]
```

```
/NODEMAND_ZERO
```

Qualifier Values

PER_PAGE

On x86-64 and I64 systems, directs the linker to compress trailing zeros for each segment (that is, demand-zero compression of zeros on trailing pages).

On Alpha systems, enables the linker to perform demand-zero compression on Alpha images on a per-page basis. If this keyword is not used, the linker performs demand-zero compression on an image-section basis only.

Description

On x86-64 and I64 system, compilers identify uninitialized sections by setting the `NOBITS` section type, which is interpreted by the linker as the `NOMOD` program section attribute.

On Alpha systems, compilers identify to the linker which program sections have not been initialized by setting the `NOMOD` program section attribute.

The linker collects these uninitialized program sections into demand-zero segments (on x86-64 and I64 systems) or image sections (on Alpha systems). For more information about demand-zero segment or image section production, see Section 3.4.4 (x86-64 and I64) and Section 7.4.3 (Alpha).

If you specify the `/NODEMAND_ZERO` qualifier, the linker still gathers uninitialized program sections into demand-zero segments or image sections but writes them to disk. Thus, the virtual

memory layout of an image is the same when the `/DEMAND_ZERO` qualifier is specified and when the `/NODEMAND_ZERO` qualifier is specified.

If you specify the `/NODEMAND_ZERO` qualifier, the linker turns the demand-zero segments or image sections containing the `NOMOD` sections into regular segments or image sections. The Alpha linker sets the copy-on-reference (CRF) attribute if the write (WRT) attribute is set.

To force the linker to write a section to disk that otherwise would be included in a demand-zero segment or image section, turn off the `NOMOD` attribute of the section by using the `PSECT_ATTRIBUTE=` option, as in the following example:

```
PSECT_ATTRIBUTE=psect-name,MOD
```

Note that only language processors can set the `NOMOD` attribute of a section.

Examples

1. `$ LINK/NODEMAND_ZERO`

In this example, the linker does not perform demand-zero compression.

2. `$ LINK/DEMAND_ZERO`

In this example, the linker by default performs demand-zero compression on a per-segment basis (on x86-64 and I64 systems) or per-image-section basis (on Alpha systems).

3. `$ LINK/DEMAND_ZERO=PER_PAGE`

In this example, on x86-64 and I64 systems, the linker performs demand-zero compression on both a per-segment and per-trailing-pages basis. On Alpha systems, the linker performs demand-zero compression on both a per-image-section and per-page basis.

/DNI (x86-64 and I64)

`/DNI` (x86-64 and I64) — Controls the processing of the demangling information. Specify `/DNI` (the default) to allow the linker to attempt symbol name demangling and move the necessary demangling information into the shareable image being created.

Format

```
/DNI (default)
```

```
/NODNI
```

Description

The `/DNI` qualifier controls the processing of the demangling information.

The object modules generated by the VSI C, VSI C++, GNAT Pro Ada, and possibly other compilers can have symbol names in the symbol table that have been altered; a process is commonly referred to as "mangling". These names are the symbol names visible to the linker, which the linker uses for symbol resolution.

The reason for mangling can be an overload feature in the programming language or simply the need to uniquely shorten names. When you link such modules and get an undefined-symbol

message, the linker displays only the symbol name from the object module's symbol table (that is, the mangled name). This processing makes it difficult to match the undefined, mangled symbol with the unmangled, source code name. The linker displays the source code name; that is, the linker can "demangle" the undefined symbol name. Further, if there is demangling information for universal symbols (that is, those to be exported from a shareable image), the linker can include that information in the generated shareable images so that when you link against the shareable image at a later time, the linker can demangle the name when it issues an error message.

The symbol resolution process remains unchanged. The linker still uses the mangled symbol names for symbol definitions and to resolve symbol references. The symbol vector option remains the same as well; it still requires the names found in the symbol tables (the mangled names).

Specify `/DNI` (the default) to allow the linker to attempt symbol name demangling and move the necessary demangling information into the shareable image being created. Specify `/NODNI` when:

- You do not want the demangled names to be displayed in error messages.
- You do not want the demangling information to be moved into the shareable image.

`/DSF (64-Bit Systems)`

`/DSF (64-Bit Systems)` — Directs the linker to create a file called a debug symbol file (DSF) for use by the OpenVMS Debugger or the OpenVMS System-Code Debugger.

Format

```
/DSF[=file-spec]
```

```
/NODSF (default)
```

Qualifier Values

`file-spec`

Specifies the character string you want the linker to use as the name of the debug symbol file. If you do not include a file type in the character string, the linker appends the `.DSF` file type to the file name.

If you specify the `/DSF` qualifier without the file specification, the linker creates a debug symbol file with the file name of the first input file and the default file type `.DSF`. If you append the `/DSF` qualifier to one of the input file specifications, the linker creates a debug symbol file with the file name of the file to which the qualifier is appended and with the default file type `.DSF`.

The OpenVMS Debugger (whether you use it in System-Code Debugger mode or user mode) requires that the name of the DSF file be the same as the name of the image file, except that the file extension is `.DSF`. If you use the `/EXECUTABLE` or `/SHAREABLE` qualifier and a file name with the `LINK` command, you must also include the same file name with the `/DSF` qualifier. (You must also use the `.DSF` file type).

Description

The `/DSF` qualifier directs the linker to create a separate file to contain the debug information used by the OpenVMS Debugger. The `/DSF` qualifier can be used with the `/NOTRACE` qualifier to suppress the call of `SY$IMGSTA` at activation time. For x86-64 and I64 linking, the `/DSF` qualifier

determines link flags and if traceback information is written into the image file (see Table 3.9). For Alpha linking, the /DSF qualifier has no effect on the contents of the image, including the image header. For more information on the effects of using /DSF combined with /DEBUG and /TRACE, see /DEBUG.

To use the information in the DSF file when you run the image and in case the DSF file is not in the same directory as the image file, you must define the logical name `DBG$IMAGE_DSF_PATH` to point to disk and directory where the DSF file resides. For more information, see the *VSI OpenVMS Debugger Manual*.

Example

```
$ LINK/DSF/NOTRACE MY_PROG.OBJ
```

In this example, the linker creates the files `MY_PROG.DSF` and `MY_PROG.EXE`.

/EXECUTABLE

/EXECUTABLE — Directs the linker to create an executable image, as opposed to a shareable image or a system image.

Format

```
/EXECUTABLE[=file-spec] (default)
```

```
/NOEXECUTABLE
```

Qualifier Values

file-spec

Specifies the character string you want the linker to use as the name of the image file produced by the link operation. If you do not specify a file type in the character string, the linker assigns the .EXE file type by default.

If you do not specify a file name with the /EXECUTABLE qualifier, the linker creates an executable image with the file name of the first input file. If you append the /EXECUTABLE qualifier to an input file specification, the linker creates an executable image with the file name of the file to which the qualifier is appended.

Description

The /NOEXECUTABLE qualifier directs the linker to perform the linking operation but to not create an image file. Use the /NOEXECUTABLE qualifier to have the linker process the input files you specify without creating an image file to check for errors in your LINK command syntax or other link-time errors. You can also use the linker to produce a map file or symbol table file only by specifying the /NOEXECUTABLE qualifier with the /MAP qualifier or the /SYMBOL_TABLE qualifier.

The linker assumes the /EXECUTABLE qualifier as the default unless you specify the /NOEXECUTABLE qualifier, the /SHAREABLE qualifier, or the /SYSTEM qualifier. Note, however, that on Alpha and VAX, when used with the /SYSTEM qualifier, you can use the /EXECUTABLE qualifier to specify the name of a system image.

Examples

1. `$ LINK/NOEXECUTABLE MY_PROG`

This example directs the linker to link the object module in the file MY_PROG.OBJ without creating an image file.

2. `$ LINK/EXECUTABLE MY_PROG`

This example directs the linker to produce an executable image named MY_PROG.EXE. (The command line `$ LINK MY_PROG` will yield the same result because the `/EXECUTABLE` qualifier is the default).

3. `$ LINK/EXECUTABLE=MY_IMAGE MY_PROG`

This example directs the linker to produce an executable image with the name MY_IMAGE.EXE instead of the name MY_PROG.EXE.

/FP_MODE (x86-64 and I64)

`/FP_MODE (x86-64 and I64)` — Determines the program's initial floating-point mode when one is not provided by the module that provides the main transfer address.

Format

`/FP_MODE=keyword`

`/NOFP_MODE (default)`

Qualifier Values

keyword

The linker accepts the following keywords to set the floating-point mode:

Keyword	Description
D_FLOAT, G_FLOAT	Sets VAX floating-point modes.
IEEE_FLOAT[=ieee_behavior]	Sets the IEEE floating-point mode to the default or a specific behavior. The OpenVMS x86-64 and I64 linkers accept the following IEEE behavior keywords: FAST UNDERFLOW_TO_ZERO DENORM_RESULTS (default) INEXACT
LITERAL=fp_ctrl_mask	Sets the floating-point mode to a literal control mask. You can express this mask as a decimal (%D), octal (%O), or hexadecimal (%X) value (for example, %X09800000, which is equivalent to the default, IEEE_FLOAT=DENORM_RESULTS).

Description

The OpenVMS x86-64 and I64 linkers determine the program's initial floating-point mode using the floating point mode provided by the module that provides the main transfer address. Use

the `/FP_MODE` qualifier to set an initial floating point mode only if the module that provides the main transfer address does not provide an initial floating-point mode. The `/FP_MODE` qualifier does not override an initial floating point mode provided by the main transfer module.

For more information about the initial floating-point mode, see the *VSI OpenVMS Calling Standard*.

/FULL

`/FULL` — Directs the linker to create a full image map file. For more information, see also the `/MAP`, `/CROSS_REFERENCE`, and `/BRIEF` qualifiers.

Format

```
/MAP/FULL[(keyword[ , . . . ])]
```

Qualifier Values

keyword (x86-64, I64)

The OpenVMS x86-64 I64 linkers accept the following keywords to tailor the map (the default is `/FULL=SECTION_DETAILS`):

Keyword	Description
ALL	For the OpenVMS x86-64 and I64 linkers, the ALL keyword is equivalent to specifying the DEMANGLED_SYMBOLS, GROUP_SECTIONS and SECTION_DETAILS keywords.
DEMANGLED_SYMBOLS	For the OpenVMS x86-64 and I64 linkers, when display name information is available and processed (DNI), directs the linkers to add a translation table to the map file. The table contains both mangled and demangled names for global symbols.
GROUP_SECTIONS	Directs the OpenVMS x86-64 and I64 linkers to list all processed groups.
[NO]SECTION_DETAILS	Directs whether or not the OpenVMS x86-64 and I64 linkers suppress zero length contributions in the Program Section Synopsis.

Description

On x86-64 and I64 systems, a full map contains the following sections:

- Object and Image Synopsis
- Cluster Synopsis
- Image Segment Synopsis
- Program Section Synopsis
- Symbols By Name (and the Symbol Cross-Reference section if the `/CROSS_REFERENCE` qualifier is specified)
- Symbols By Value

- Image Synopsis
- Link Run Statistics

On Alpha and VAX systems, a full map contains the following sections:

- Object Module Synopsis
- Module Relocatable Reference Synopsis (VAX only)
- Image Section Synopsis
- Program Section Synopsis
- Symbols By Name (and the Symbol Cross-Reference section if the `/CROSS_REFERENCE` qualifier is specified)
- Symbols By Value
- Image Synopsis
- Link Run Statistics

By default, a full linker map lists all the module contributions in the Program Section Synopsis on all systems.

The full map also contains information about modules included from the default system libraries `STARLET.OLB` and `IMAGELIB.OLB` in the Object Module Synopsis, Program Section Synopsis, and Symbols By Name sections. For more information about image map files, see Chapter 5 (x86-64 and I64) and Chapter 9 (Alpha and VAX).

The `/FULL` qualifier is valid only if you also specify the `/MAP` qualifier in the `LINK` command. The `/FULL` qualifier is compatible with the `/CROSS_REFERENCE` qualifier, but it is not compatible with the `/BRIEF` qualifier.

On x86-64 and I64 systems, you can request a map section containing a translation table for the global symbol definitions. This table correlates the mangled symbol names with their demangled equivalents. By default, the linker does not generate this section in the map file. To request this section, specify the keyword `DEMANGLED_SYMBOLS` to the `/FULL` qualifier. As with other keywords for the `/FULL` qualifier, specify the `/MAP` qualifier. You should not specify the `/NODNI` qualifier. The translation table in the map can be helpful to verify the symbol vector entries.

Example

```
$ LINK/MAP/FULL MY_PROG
```

This example directs the linker to produce a full image map named `MY_PROG.MAP`.

/GST (64-Bit Systems)

`/GST (64-Bit Systems)` — Directs the linker to include in the global symbol table (GST) of a shareable image those symbols that have been declared as universal symbols in a symbol vector.

Format

/GST (default)

/NOGST

Description

By default, the linker lists in the GST of a shareable image the global symbols in the image that have been declared universal. By listing these symbols in the GST, the linker allows them to be referenced in link operations where the shareable image is specified as an input file.

To create a shareable image that can be activated by the images that linked against it, but that cannot be used to resolve symbolic references in a link operation, you can specify the /NOGST qualifier. When this qualifier is specified, the linker creates the image with an empty GST. (The linker still creates a GST). By using the /NOGST qualifier, you can create a run-time version of a shareable image without having to remove the symbol vector from the link operation.

The images that were linked against the shareable image can still access symbols within the image because the /NOGST qualifier does not affect the symbol vector in the image.

This qualifier is valid only when used with the /SHAREABLE qualifier to create a shareable image.

Example

```
$ LINK/NOGST/SHAREABLE MY_SHARE,UNIVERSALS/OPTIONS
```

This example creates the shareable image MY_PROG.EXE without listing entries for universal symbols in its global symbol table. The image contains an empty global symbol table.

/HEADER (Alpha and VAX)

/HEADER (Alpha and VAX) — On Alpha and VAX systems, when specified with the /SYSTEM qualifier, directs the linker to include an image header in a system image.

Format

/HEADER

/NOHEADER (default)

Description

On Alpha and VAX systems, the linker always creates executable images and shareable images with headers; a required component of those image files. The linker creates system images without a header by default. To create a system image with a header, you must specify the /HEADER qualifier along with the /SYSTEM qualifier on the command line.

The linker ignores the /HEADER qualifier if it is specified for any other type of image (executable or shareable).

Example

```
$ LINK/SYSTEM/HEADER MY_SYS
```

This example directs the linker to produce a system image named MY_SYS.EXE with an image header. For more information about when to specify the /HEADER qualifier with the /SYSTEM qualifier, see the description of the /SYSTEM qualifier.

/INCLUDE

/INCLUDE — Identifies the input file specification to which it is appended as a library file and directs the linker to include in the link operation the module or modules specified as the value of the qualifier.

Format

```
library-name /INCLUDE=(module-name [ , . . . ])
```

Qualifier Values

library-name

Specifies the name of the library from which you want a module or modules extracted. The file name must specify a library file. The linker assumes the default file type of .OLB.

module-name

Specifies the module or modules that you want to extract from the library. To specify more than one module, enclose the list in parentheses and separate the module names with commas.

Description

Note that the /INCLUDE qualifier does not cause the linker to process the library for the definitions of unresolved symbolic references. If you want the linker to search the library for definitions of unresolved symbols, you must also specify the /LIBRARY qualifier before the /INCLUDE qualifier.

Examples

1. `$ LINK MY_PROG,MY_LIB /INCLUDE=(MOD1,MOD2,MOD5)`

This example directs the linker to include modules MOD1, MOD2, and MOD5 from the library MY_LIB.OLB in the link operation with MY_PROG.

2. `$ LINK MY_PROG,MY_LIB /LIBRARY /INCLUDE=(MOD1,MOD2,MOD5)`

This example directs the linker to extract modules MOD1, MOD2, and MOD5 from the library MY_LIB.OLB and then to search that library for symbol definitions that are unresolved in all four modules.

/INFORMATIONALS

/INFORMATIONALS — Directs the linker to output informational messages produced by a link operation.

Format

`/INFORMATIONALS` (default)

`/NOINFORMATIONALS`

Description

The linker outputs informational messages by default. To suppress informational messages, specify the `/NOINFORMATIONALS` qualifier.

Example

```
$ LINK/NOINFORMATIONALS MY_PROG
```

When the `/NOINFORMATIONALS` qualifier is specified, informational messages are suppressed.

/LIBRARY

`/LIBRARY` — Identifies the input file specification to which it is appended as a library file and directs the linker to process the library's name table as part of its symbol resolution processing. When the linker finds in the library the definition of a symbol referenced in a previously processed input file, the linker includes from the library the module in which the symbol is defined.

Format

`library-name/LIBRARY`

Qualifier Values

library-name

Specifies the name of the library to be included in the link operation. You must specify a library file. The linker assumes the default file type of `.OLB`.

Description

The order in which a library file is specified in the command string (or in an options file) is important because the linker uses the library file to resolve undefined symbols in previously processed (not subsequently processed) modules *only*. For more information about how the linker processes input files to resolve symbolic references, see Chapter 2 (x86-64 and I64) and Chapter 6 (Alpha and VAX).

Note that shareable image libraries do not contain a copy of an image. They contain the image's name, the image's identification information and a table including the image's universal symbols. The identification information is provided by the `GSMATCH=` option, when the shareable image is linked. (See the `GSMATCH=` option for more information).

It is possible that a shareable image is relinked but a library is not updated. To handle this case, the linker looks for compatibility. On Alpha and VAX systems, the linker makes the same verification that the image activator does; that is, it uses the `GSMATCH` criteria to verify compatibility.

On VAX systems, the linker also compares against the date and time, signaling `LINK-I-DATMISMCH`, if they are different.

On Alpha systems, the initial behavior of the linker was the same as the VAX linker. The check was seen as too sensitive and the default behavior was changed to use only the GSMATCH criteria. If you prefer, you can obtain the former VAX behavior by setting the logical name LINK\$SHR_DATE_CHECK.

Examples

1. `$ LINK MY_PROG,MY_LIB/LIBRARY,PROG2,PROG3`

In this example, the linker uses the library MY_LIB.OLB to resolve undefined symbols in MY_PROG, but not in PROG2 or PROG3.

2. `$ LINK MY_PROG,PROG2,PROG3,MY_LIB/LIBRARY`

In this example, the linker can resolve undefined symbols in MY_PROG, PROG2, and PROG3 from the library MY_LIB.OLB.

/MAP

/MAP — Directs the linker to create an image map file.

For more information, see also the /BRIEF, /CROSS_REFERENCE, and /FULL qualifiers.

Format

`/MAP[=file-spec]/NOBRIEF/NOCROSS_REFERENCE/NOFULL`
(default in batch mode)

`/NOMAP`
(default in interactive mode)

Qualifier Values

file-spec

If you enter a file specification with the /MAP qualifier, the linker creates an image map file with that file name. If you do not enter a file type after the file name, the linker assumes a file type of .MAP.

If you do not enter a file specification with the /MAP qualifier, the linker creates an image map file with the file name of the first input file specified on the command line and the file type .MAP. (If there are no input files specified on the command line, the linker names the map file .MAP).

If you append the /MAP qualifier to one of the input file specifications, the linker creates an image map file with the file name of the file to which the qualifier is appended, using the .MAP file type.

Description

On OpenVMS x86-64 and I64 systems, the /MAP qualifier causes the linker to produce a default image map file containing the following sections:

- Object and Image Synopsis
- Program Section Synopsis
- Symbols By Name
- Image Synopsis

- Link Run Statistics

On OpenVMS Alpha and VAX systems, the /MAP qualifier causes the linker to produce a default image map file containing the following sections:

- Object Module Synopsis
- Program Section Synopsis
- Symbols By Name
- Link Run Statistics

See Chapter 5 (x86-64 and I64) and Chapter 9 (Alpha and VAX) for more information about image map files.

Examples

1. `$ LINK/MAP MY_PROG`

This example directs the linker to produce an image map with the default name of MY_PROG.MAP.

2. `$ LINK/MAP=MY_MAP MY_PROG`

This example directs the linker to produce an image map with the name of MY_MAP.MAP instead of the default name of MY_PROG.MAP.

3. `$ LINK MY_PROG,MY_SUB/MAP`

This example directs the linker to produce an image map with the default name of MY_SUB.MAP.

4. `$ LINK MY_PROG,SY$INPUT/OPTIONS/MAP
MY_SHARE/SHAREABLE
Ctrl/Z`

This example directs the linker to produce an image map with the default name of .MAP, because SY\$INPUT is a device specification without a file name.

/NATIVE_ONLY (I64 and Alpha)

/NATIVE_ONLY (I64 and Alpha) — On I64 and Alpha systems, prevents the linker from generating procedure signature information.

Format

`/NATIVE_ONLY (default)`

`/NONATIVE_ONLY`

Description

On I64 and Alpha systems, prevents the linker from generating procedure signature information. Procedure signatures are required to allow the native code being linked to interoperate with images translated from either VAX or Alpha binary code. To build an executable or shareable image that calls or can be called by translated code, link it using /NONATIVE_ONLY. Code that is to interoperate

with translated images must also be compiled using the /TIE qualifier. (See the associated compiler documentation for details).

Since OpenVMS x86-64 does not support translated imaged, this option is ignored on x86-64 systems.

Example

1. `$ LINK/NATIVE_ONLY MY_PROG`

In this example, the linker creates an image, named MY_PROG.EXE, that cannot interoperate with translated OpenVMS images.

2. `$ LINK/NONATIVE_ONLY MY_PROG`

In this example, the linker creates an image, named MY_PROG.EXE, that can interoperate with translated OpenVMS images.

/OPTIONS

/OPTIONS — Identifies the input file specification to which it is appended as a linker options file.

Format

`options-file-name/OPTIONS`

Qualifier Values

options-file-name

The file specification of a linker options file. The linker assumes the file type .OPT by default.

Description

A linker options file can contain linker option specifications and input file specifications. For information about creating an options file, see Chapter 1.

Examples

1. `$ LINK MY_PROG,MY_OPTIONS/OPTIONS`

This example directs the linker to use an options file named MY_OPTIONS.OPT to produce an executable image named MY_PROG.EXE.

2. `$ LINK MY_PROG,SY$INPUT/OPTIONSMY_SHARE/SHAREABLE
Ctrl/Z`

This example illustrates how to create an options file interactively by specifying SY\$INPUT as the file specification. After entering the options, press Ctrl/Z to end the options file.

/P0IMAGE

/P0IMAGE — Directs the linker to place an executable image entirely in P0 address space. When the /P0IMAGE qualifier is specified, the user stack and OpenVMS RMS buffers, which usually reside in P1 space, are placed in P0 space by the image activator.

Format

`/P0IMAGE`

`/NOP0IMAGE` (default)

Description

For Alpha and VAX, note that the address of the stack shown in the map of an image linked with the `/P0IMAGE` qualifier does not reflect the true address of the stack at run-time because, when `/P0IMAGE` is specified, the virtual address space for the stack is dynamically allocated at the end of P0 space at run-time.

`/P0IMAGE` is used to create executable images that modify P1 address space.

Example

```
$ LINK/P0IMAGE MY_PROG
```

This example directs the linker to set up an executable image named `MY_PROG.EXE` to be run entirely in the P0 address space.

/PROTECT

`/PROTECT` — Directs the linker to protect an entire shareable image from user-mode write access and supervisor-mode write access. Can be specified only with the `/SHAREABLE` qualifier.

Format

`/PROTECT`

`/NOPROTECT` (default)

Description

The `/PROTECT` qualifier protects an entire shareable image from user-mode write access and supervisor-mode write access. To protect only specific segments (on x86-64 and I64 systems) or image sections (on Alpha systems) within a shareable image, but not the entire shareable image, use the `PROTECT=` option. For more information about using the `PROTECT=` option, see its description later in this section.

The `/PROTECT` qualifier is commonly used to protect shareable images that are used to implement user-written system services (called privileged shareable images) from user-mode access.

On x86-64 and I64 systems, it is recommended to protect the whole image with the `/PROTECT` qualifier (see Section 4.4).

The `/PROTECT` qualifier is incompatible with the `/EXECUTABLE` qualifier and the `/SYSTEM` qualifier.

Example

```
$ LINK/SHAREABLE/PROTECT MY_SHARE
```

This example directs the linker to produce a privileged shareable image named MY_SHARE.EXE.

/REPLACE (Alpha Only)

/REPLACE (Alpha Only) — For Alpha linking, specifies that the linker should perform certain optimizations to improve the performance of the resultant image, when instructed by the compiler. This qualifier is ignored by the OpenVMS x86-64 and I64 linkers.

Format

```
/REPLACE (default)
```

```
/NOREPLACE
```

Description

For Alpha linking, it is more efficient to execute a procedure call as a branch, using the BSR (Branch to Subroutine) instruction sequence, than it is to execute the call as a jump, using the JSR (Jump to Subroutine) instruction sequence. In a BSR instruction, the destination can be expressed as an offset, requiring fewer memory fetches than a JSR instruction sequence.

Compilers cannot always take advantage of the efficiency of the BSR instruction because the information needed to calculate the offset is not available until link time, when the linker lays out the image sections that make up the image. To achieve this performance enhancement, compilers flag uses of the JSR instruction sequence and the linker examines each use and attempts to replace it with the BSR instruction sequence wherever possible.

In addition to code replacement, the linker can also specify **hints** to improve the performance of the JSR instructions that remain in the image. A hint is used to index the instruction cache and can improve performance. Hints are generated for JSR instructions within the image and for JSR instructions to shareable images.

/SECTION_BINDING (Alpha Only)

/SECTION_BINDING (Alpha Only) — For Alpha linking, directs the linker to create an image that can be installed as a resident image and to flag coding practices in the image that would prevent this. This qualifier is ignored by the OpenVMS x86-64 and I64 linkers. The x86-64 and I64 linkers always produce images that can be installed as resident images.

Format

```
/[NO]SECTION_BINDING[=(CODE,DATA)]
```

```
/NOSECTION_BINDING (default)
```

Qualifier Values

CODE

Prevents the linker from replacing the Jump to Subroutine (JSR) instruction sequence with the more efficient Branch to Subroutine (BSR) instruction sequence when the target of the branch crosses an image section boundary.

DATA

Directs the linker to check for address calculations that create dependencies on the layout of data image sections. The linker reports such occurrences.

When the `/SECTION_BINDING` qualifier is specified without either the `CODE` or `DATA` keyword, the linker performs both types of checking by default.

Description

For Alpha linking, you can improve the performance of an installed image by installing it as a resident image (by using the `/RESIDENT` qualifier of the `Install` utility). The `Install` utility moves portions of resident images into system space where they reside on a large single page with granularity hints set (called a granularity hint region or GHR), thus improving performance.

For an image to be installed as a resident image, it must not contain any dependencies on the layout of image sections, such as branch instructions that cross image section boundaries. The offsets calculated by the linker for such branches depend on the layout of the image sections. The relative position of the code image sections changes when they are moved to system space and the accuracy of the offsets calculated by the linker is destroyed. (These dependencies are created by the linker when it replaces the `JSR` instruction sequence with the `BSR` instruction sequence. For more information, see the description of the `/REPLACE` qualifier).

When the `/SECTION_BINDING` qualifier is specified, the linker does not replace `JSR` instructions when the destination crosses an image section boundary. The linker still replaces the `JSR` instruction sequence for calls that stay within the boundaries of an image section.

In addition to eliminating image section layout dependencies in code image sections, the linker can also check the data image sections in an image to see if they contain coding practices that produce dependencies on image section layout.

The image activator can reposition data image sections to eliminate the gaps in virtual memory left by the code image sections that were moved to system space. However, data image sections can also contain dependencies on image section layout. For example, when an image initializes an address by performing arithmetic on two addresses that reside in two different image sections, the address calculation creates a dependency on the layout of the data image sections, as in the following example:

```
OWN
  FOO: INITIAL ( FOO - BAR)
```

If the linker detects the compiler adding or subtracting two intra-image addresses, it assumes that a relative branch is being calculated and displays the following warning:

```
%LINK-W-BINDFAIL, failed to bind reference at %X00030000 between sections
  at locations %X00030000 and %X00010000
  in module X file WORK:[TEST]X.OBJ;6
```

The warning message produced by the linker indicates the two addresses being operated on and the virtual address where it was trying to write the result. To find the source code that is creating the dependency, examine the map file to determine what entities reside at these addresses and then search the source code for places where they are used in calculations. In this example, module `X` contained a data cell, `FOO`, initialized with the difference between `FOO`'s address and `BAR`'s (as in the previous code example). In the image map, `FOO` resides at `%X00030000` and `BAR` at `%X00010000`. Because these addresses appear in different image sections, the calculation introduces a dependency on the layout of image sections. To fix this dependency, rewrite the source code to remove the calculation

or move the two data cells into the same image section by using the COLLECT= option or the PSECT_ATTRIBUTE= option.

The linker issues a message for each address calculation in data image sections that create dependencies on the layout of image sections, as in the following example:

```
%LINK-W-BINDISABLE, section binding of data has been disabled
%LINK-W-BINDFAIL, failed to bind reference at %X0000865D between sections
    at locations %X00008000 and %X00000000
    in module MKDRIVER file X56Y_RESD$:[DRIVER.OBJ]DRIVER.OLB;1
%LINK-W-BINDFAIL, failed to bind reference at %X00008665 between sections
    at locations %X00008000 and %X00000000
    in module MKDRIVER file X56Y_RESD$:[DRIVER.OBJ]DRIVER.OLB;1
%LINK-W-BINDFAIL, failed to bind reference at %X0000866D between sections
    at locations %X00008000 and %X00000000
    in module MKDRIVER file X56Y_RESD$:[DRIVER.OBJ]DRIVER.OLB;1
```

Example

```
$ LINK/SHAREABLE/SECTION_BINDING MY_PROG
```

In this example, the linker creates the image MY_PROG.EXE and processes it so that it can be installed as a resident image.

/SEGMENT_ATTRIBUTE (x86-64 and I64)

/SEGMENT_ATTRIBUTE (x86-64 and I64) — Instructs the OpenVMS x86-64 and I64 linkers to set certain attributes for segments.

Format

```
/SEGMENT_ATTRIBUTE=(segm-attribute[,...])
```

Qualifier Values

segm-attribute

The linker accept the following keywords to set segment attributes:

```
CODE=address_region
DYNAMIC=address_region
SHORT_DATA=WRITE (I64 only)
SYMBOL_VECTOR=[NO]SHORT
```

where an *address_region* can be specified with keywords P0 and P2.

Description

By default, the linker assigns code segments to P2 space on x86-64 systems and P0 space on I64 systems. With the CODE=P0 or CODE=P2 keywords, you can override the default spaces for placing code segments. When the image activator activates an image, code segments will be placed in the space specified by the CODE=*address_region* keyword.

By default, the linker puts the dynamic segment, which contains information for the image activator, into P2 space. For images not activated by the OpenVMS image activator, DYNAMIC=P0 forces the linker to put the dynamic segment into P0 space. This qualifier is primarily used by system developers.

On I64 systems, the `SHORT_DATA=WRITE` keyword allows you to combine the read-only and the read-write short data segments into a single segment, reclaiming up to 65,535 bytes of unused, read-only space (when `/BPAGE=16`, the default value). When setting `SHORT_DATA` to `WRITE`, your program may accidentally write to formerly read-only data. Therefore, this qualifier is recommended only if your short data segment has reached the limit of 4 MB.

By default, for shareable images, the linker stores the symbol vector into the read-only short data segment. By specifying `SYMBOL_VECTOR=NOSHORT`, the linker collects the symbol vector into a read-only data segment of the default cluster. If the shareable image has none, such a segment is created. This frees up the short data of the symbol vector entries. This qualifier is recommended only if your short data segment has reached the limit of 4 MB.

/SELECTIVE_SEARCH

`/SELECTIVE_SEARCH` — When this qualifier is appended to an input file specification, the linker processes only those symbols in the input file that have been referenced by previously processed input files.

Format

```
input-file-name/SELECTIVE_SEARCH
```

Qualifier Values

input-file-name

The input file you want included in the link operation. The `/SELECTIVE_SEARCH` qualifier works with object modules and shareable images only. This qualifier is illegal with library files. (To process the modules in a library selectively, you specify the `/SELECTIVE_SEARCH` qualifier when inserting the files into the library. For more information, see the *VSI OpenVMS Command Definition, Librarian, and Message Utilities Manual*).

Description

If you do not specify the `/SELECTIVE_SEARCH` qualifier with an input file, the linker includes all the input file's global symbols in the linker's internal global symbol table for symbol resolution by default.

Note that the `/SELECTIVE_SEARCH` qualifier does not affect the size of the resultant image. The entire object module is included in the image, even if only a subset of the symbols in its global symbol table are needed to resolve symbolic references. Specifying the `/SELECTIVE_SEARCH` qualifier can improve the performance of a link operation and conserve the linker's use of virtual memory.

Examples

```
1. $ LINK/MAP MY_MAIN,MY_PROG/SELECTIVE_SEARCH
```

In this example, the linker processes the object module `MY_PROG.OBJ` selectively. You can verify this processing by checking the list of symbols in the image map file created in this link. The only symbols from the file `MY_PROG.OBJ` that will appear in the map file are those symbols that were referenced by `MY_MAIN.OBJ`.

```
2. $ LINK/MAP=MY_MAIN/EXECUTABLE=MY_MAIN SYS$INPUT/OPTIONS
   CLUSTER=MY_MAIN_CLUS, , ,MY_MAIN
```

```
MY_SHARE/SHAREABLE/SELECTIVE_SEARCH
Ctrl/Z
```

In this example, the linker processes the shareable image MY_SHARE.EXE selectively. Note that, to ensure that the linker processes references to symbols in the shareable image before it processes the shareable image selectively, the input file MY_MAIN.OBJ is placed in a named cluster(MY_MAIN_CLUS), using the CLUSTER= option. If the object modules had been specified on the LINK command line, the linker would have put it in the default cluster. The linker processes named clusters before it processes the default cluster.

3. \$ LIBRARIAN/INSERT/SELECTIVE_SEARCH MY_LIB MY_PROG
\$ LINK MY_PROG,MY_LIB/LIBRARY

In this example, the object module MY_PROG.OBJ is inserted into the library MY_LIB.OLB selectively. When the library is specified in a link operation, the linker processes the object module selectively. This link operation is equivalent to the link operation in Example 1.

/SHAREABLE

/SHAREABLE — When specified anywhere on the LINK command line, the /SHAREABLE qualifier directs the linker to create a shareable image. When the /SHAREABLE qualifier is appended to a file specification in a linker options file, it identifies the input file as a shareable image.

Format

```
/SHAREABLE[=file-spec]
```

```
/NOSHAREABLE (default)
```

```
shareable-image-file-name/SHAREABLE
```

Qualifier Values

file-spec

When the /SHAREABLE qualifier is used to create a shareable image, this parameter specifies the name you want the linker to assign to the shareable image being created. If you do not include a file specification, the linker assigns the shareable image the name of the file to which the /SHAREABLE qualifier is appended in the LINK command line. If the /SHAREABLE qualifier is not appended to an input file specification, the linker assigns to the shareable image the name of the first input file specified on the command line using the extension .EXE.

If you designate a file name but omit the file type, the linker assigns the shareable image the file type .EXE.

shareable-image-file-name

Specifies the name of a shareable image. Note that you can use the /SHAREABLE qualifier to identify a shareable image only in a linker options file. It is illegal to include a shareable image in a link operation by specifying it on the LINK command line.

Description

The linker creates executable images by default; you must specify the /SHAREABLE qualifier to create a shareable image. The /SHAREABLE qualifier is incompatible with the /SYSTEM qualifier.

For more information about creating and using shareable images, see Chapter 4 (x86-64 and I64) and Chapter 8 (Alpha and VAX).

Examples

1. `$ LINK/SHAREABLE MY_SHARE, UNIVERSALS/OPTIONS`

This example directs the linker to produce a shareable image named MY_SHARE.EXE. The options file UNIVERSALS.OPT contains declarations of the universal symbols in the shareable image.

2. `$ LINK/SHAREABLE=MY_APP MY_SHARE, UNIVERSALS/OPTIONS`

This example directs the linker to produce a shareable image named MY_APP.EXE using the object module MY_SHARE.OBJ as input.

3. `$ TYPE MY_OPTIONS.OPTMY_SHARE/SHAREABLE`
`$ LINK MY_PROG,MY_OPTIONS.OPT/OPTIONS`

In this example, a shareable image is included in a link operation. The shareable image is specified in the options file MY_OPTIONS.OPT, which is specified as an input file on the LINK command line.

4. `$ LINK MY_PROG,SY$INPUT/OPTIONS`
`MY_SHARE/SHAREABLE`
`Ctrl/Z`

This example shows how the shareable image MY_SHARE.EXE is used, together with the object file MY_PROG.OBJ, to create an executable image named MY_PROG.EXE.

Note how you can specify options interactively at the command line by identifying the logical name SY\$INPUT as an options file. The linker interprets the lines following the LINK command as the contents of an options file, until you terminate the options by entering the Ctrl/Z key sequence.

/SYMBOL_TABLE

/SYMBOL_TABLE — Directs the linker to create a symbol table file.

Format

/SYMBOL_TABLE[=file-spec]

/NOSYMBOL_TABLE (default)

Qualifier Values

file-spec

Specifies the character string you want the linker to use as the name of the symbol table file. If you do not include a file type in the character string, the linker appends the .STB file type to the file name.

If you specify the /SYMBOL_TABLE qualifier without the file specification, the linker creates a symbol table file with the file name of the first input file and the default file type .STB. If you append the /SYMBOL_TABLE qualifier to one of the input file specifications, the linker creates a symbol table file with the file name of the file to which the qualifier is appended, with the default file type .STB.

Description

A symbol table file contains a copy of the image's global symbol table, excluding definitions from shareable images, in object module format.

On 64-bit systems, you cannot specify symbol table files as input files in a link operation. Symbol table files of images are intended only as an aid in debugging crash dumps using the OpenVMS System Dump Analyzer utility (SDA). For more information, see Section 1.2.4.

On 64-bit systems, note that you can direct the linker to include global symbols in a symbol table file associated with a shareable image by specifying the `SYMBOL_TABLE=GLOBALS` option. When you specify this option, the linker includes global symbols as well as universal symbols in a symbol table file by default.

On VAX systems, a global symbol table produced by a link that creates a shareable image contains only universal symbols. A global symbol table produced by a link that creates an executable image contains all the global symbols in the image.

On VAX systems, you can specify symbol table files as input files in link operations if they were produced in an operation in which an executable or system image was created. Symbol table files produced in a link operation in which a shareable image was created do not always contain enough information to be used as input files in link operations. For more information, see Section 1.2.4.

Examples

1. `$ LINK/SYMBOL_TABLE/NOEXECUTABLE MY_PROG`

In this example, the linker produces a symbol table file named `MY_PROG.STB` without producing an executable image.

2. `$ LINK/SYMBOL_TABLE=MY_PROG_SYMB_TAB MY_PROG`

In this example, the linker produces a symbol table file named `MY_PROG_SYMB_TAB.STB`. An executable image file named `MY_PROG.EXE` is also produced.

3. `$ LINK/SHAREABLE/SYMBOL_TABLE MY_SHARE,SYSS$INPUT/OPTIONS
GSMATCH=LEQUAL,1,1000
SYMBOL_VECTOR=(MYPROC=PROCEDURE, -
MYDATA=DATA, -
MYPROC2=PROCEDURE)SYMBOL_TABLE=GLOBALS
Ctrl/Z`

In this example, the linker creates a symbol table file on 64-bit systems, named `MY_SHARE.STB`, that contains both global symbols and universal symbols because the linker option `SYMBOL_TABLE=GLOBALS` is specified in the options file.

/SYSEXE (64-Bit Systems)

`/SYSEXE (64-Bit Systems)` — Directs the linker to process the system shareable image, `SYSS$BASE_IMAGE.EXE`, in a link operation. The linker looks for `SYSS$BASE_IMAGE.EXE` in the directory pointed to by the logical name `X86$LOADABLE_IMAGES` on x86-64 systems, `IA64$LOADABLE_IMAGES` on I64 systems, and `ALPHA$LOADABLE_IMAGES` on Alpha systems.

Format

```
/SYSEXE [= [NO] SELECTIVE ]
```

```
/NOSYSEXE (default)
```

Qualifier Values

SELECTIVE (default)

When the /SYSEXE qualifier is specified with no keyword, the linker processes the SYSS\$BASE_IMAGE.EXE file selectively.

When you specify /SYSEXE with the SELECTIVE keyword, the linker processes the SYSS\$BASE_IMAGE.EXE file selectively, including only those symbols from the global symbol table of the SYSS\$BASE_IMAGE.EXE file that were referenced by input files previously processed in the link operation.

NOSELECTIVE

When you specify the NOSELECTIVE keyword, the linker includes all the symbols from the SYSS\$BASE_IMAGE.EXE global symbol table in the link operation.

Description

When you specify the /SYSEXE qualifier, the linker processes the SYSS\$BASE_IMAGE.EXE file selectively *after* processing the system shareable image library, IMAGELIB.OLB, and *before* processing the system object library, STARLET.OLB, and the system service shareable image, SYSS\$PUBLIC_VECTORS.EXE, which is associated with STARLET.OLB. (By default, the linker processes IMAGELIB.OLB, STARLET.OLB, and SYSS\$PUBLIC_VECTORS.EXE, in that order, to resolve symbols that remain undefined after all the files specified in the LINK command have been processed and after any user-specified libraries have been processed). Note that the linker qualifiers that determine whether the linker processes the default system libraries, /SYSSHR and /SYSLIB, do not affect SYSS\$BASE_IMAGE.EXE processing.

If you want the linker to process SYSS\$BASE_IMAGE.EXE before processing IMAGELIB.OLB, specify SYSS\$BASE_IMAGE.EXE in an options file, as you would any other shareable image. If you specify SYSS\$BASE_IMAGE.EXE in your options file, do not specify the /SYSEXE qualifier in the LINK command.

For more information about linking against the OpenVMS executive, see Section 2.4 (x86-64 and I64) and Section 6.4 (Alpha).

Example

```
$ LINK/SHAREABLE/SYSEXE MY_SHARE, SYSS$INPUT/OPTIONS
SYMBOL_VECTOR=(MY_PROC=PROCEDURE)
Ctrl/Z
```

In this example, the linker processes the OpenVMS system executive file, SYSS\$BASE_IMAGE.EXE, to create a shareable image named MY_SHARE.EXE.

/SYSLIB

/SYSLIB — Directs the linker to process the default system shareable image library, IMAGELIB.OLB, and the default system object module library, STARLET.OLB, to resolve symbolic

references that remain undefined after all specified input files and any default user libraries have been processed.

Format

```
/SYSLIB (default)
```

```
/NOSYSLIB
```

Description

The linker first searches IMAGELIB.OLB, the default system shareable image library, then STARLET.OLB, the default system object library.

On 64-bit systems, the linker also searches the shareable image SYSS\$PUBLIC_VECTORS.EXE to resolve references to system services. (For more information about processing SYSS\$PUBLIC_VECTORS.EXE, see the description of the /SYSEXE qualifier). The linker looks for these default libraries in the directory pointed to by the logical name X86\$LIBRARY for x86-64 links, IA64\$LIBRARY for I64 links, and ALPHA\$LIBRARY for Alpha links.

For VAX linking, the linker looks for these default libraries in the directory that the logical name SYSS\$LIBRARY points to.

If you specify the /NOSYSLIB qualifier and the /SYSSHR qualifier, the /SYSSHR qualifier is ignored.

If you want the linker to search IMAGELIB.OLB but not STARLET.OLB, specify the /NOSYSLIB qualifier (to inhibit the default search of both default system libraries), and then specify IMAGELIB.OLB in the LINK command line or in an options file.

Example

```
$ LINK/NOSYSLIB MY_PROG
```

In this example, the linker creates the executable image MY_PROG.EXE without referencing the default system libraries IMAGELIB.OLB or STARLET.OLB.

/SYSSHR

/SYSSHR — Directs the linker to process the default system shareable image library (IMAGELIB.OLB) to resolve symbolic references that remain undefined after all specified input files and any default user libraries have been processed.

Format

```
/SYSSHR (default)
```

```
/NOSYSSHR
```

Description

The linker searches IMAGELIB.OLB, the default system shareable image library, and resolves symbolic references that remain undefined after all specified input files and any default user libraries have been processed.

If you want the linker to skip processing the default shareable image library, IMAGELIB.OLB, but still process the default system object library, STARLET.OLB, specify the /NOSYSSHR qualifier.

See the description of the /SYSLIB qualifier for information about controlling how the linker processes the default system libraries.

Example

```
$ LINK/NOSYSSHR MY_PROG
```

In this example, the linker processes the default system object library (STARLET.OLB), but does not process the default system shareable image library (IMAGELIB.OLB), to resolve symbolic references while producing an executable image named MY_PROG.EXE.

/SYSTEM (Alpha and VAX)

/SYSTEM (Alpha and VAX) — On Alpha and VAX systems, directs the linker to create a system image and optionally allows you to specify the address at which the image should be loaded into memory. A system image cannot be activated with the RUN command; it must be bootstrapped or otherwise loaded into memory.

Format

```
/SYSTEM[=base-address]
```

```
/NOSYSTEM (default)
```

Qualifier Values

base-address

Specifies the address at which the image is to be loaded in virtual memory. You can specify a base address in hexadecimal (%X), octal (%O), or decimal (%D) format. The default base address is %X80000000.

Note that if you specify the /HEADER qualifier, the linker adjusts the base address to the next highest page boundary if it is not already a page boundary. The next highest page boundary is the smallest number that is greater than the value specified in the **base-address** parameter and that is divisible by the default page size (which is architecture specific) or the page size specified using the /BPAGE qualifier.

Description

System images are intended for special purposes, such as standalone operating system diagnostics. When the linker creates a system image, it orders the program sections in alphanumeric order and ignores all program section attributes.

The linker creates the system image with the file name of the first input file and the file type .EXE. If you want a different output file specification, specify that file specification with the /EXECUTABLE qualifier.

If you specify the /SYSTEM qualifier, you cannot specify the /SHAREABLE qualifier or the /DEBUG qualifier.

Example

```
$ LINK/SYSTEM MY_SYS
```

This example directs the linker to produce a system image named MY_SYS.EXE based at address %X80000000.

/THREADS_ENABLE

/THREADS_ENABLE — Kernel threads allow a multithreaded application to have a thread executing on every CPU in a multiprocessor system. The **/THREADS_ENABLE** qualifier allows you to turn kernel threads on and off on a per-image basis.

Format

```
/THREADS_ENABLE [= ( MULTIPLE_KERNEL_THREADS , UPCALLS ) ]
```

```
/NOTTHREADS_ENABLE (default)
```

Qualifier Values

MULTIPLE_KERNEL_THREADS

When you specify this qualifier, the OpenVMS linker sets the appropriate bits in the dynamic segment (on x86-64 and I64 systems) or the image header (on Alpha and VAX systems) of the image being linked. These bits control the following:

- Whether the image is allowed to enter a multiple kernel threads environment
- Whether the image can receive upcalls from the OpenVMS scheduler

On 64-bit systems, this keyword sets the **MULTIPLE_KERNEL_THREADS** bit in the dynamic segment (on x86-64 and I64 systems) or the image header (on Alpha systems) of the image being built. This bit indicates to the image activator that the image can be run in a multiple kernel threads environment.

If you specify this keyword for OpenVMS VAX links, it is ignored.

UPCALLS

This qualifier sets the **UPCALLS** bit in the OpenVMS dynamic segment (on x86-64 and I64 systems) and image header (on Alpha and VAX systems) of the image being built. This bit indicates to the image activator that the process can receive upcalls from the OpenVMS scheduler.

When the **/THREADS_ENABLE** qualifier is specified without either the **MULTIPLE_KERNEL_THREADS** or **UPCALLS** keyword, the linker sets both bits by default.

Description

The principal benefit of threading is to allow you to launch multiple paths of execution within a process. With threading, you can have some threads running while others are waiting for an external event to occur, such as I/O. The multi-threading kernel of OpenVMS can place threads on separate central processing units for concurrent execution; this enables a process to run faster.

The set bits allow you to control your threads environment on a per-process basis rather than system-wide. The image activator examines these bits to determine the environment in which the image is to run.

Caution

The OpenVMS linker does no analysis whatsoever to determine if the image can be safely placed in a multiple kernel threads environment. The linker only sets the bits.

For more information on kernel threads, see the *Guide to the POSIX Threads Library*.

Examples

1. `$ LINK /NOTHEADS_ENABLE`

This command, which is the default, keeps the `MULTIPLE_KERNEL_THREADS` and `UPCALLS` bits clear in the image being built.

2. `$ LINK/THREADS_ENABLE`

For this command, the result on 64-bit systems is different from the result on VAX systems:

- On 64-bit systems, this command sets the `UPCALLS` and `MULTIPLE_KERNEL_THREADS` bits in the image being built.
- On VAX systems, the command sets only the `UPCALLS` bit in the image being built.

3. `$ LINK/THREADS_ENABLE=UPCALLS`

This command sets the `UPCALLS` bit in the images being built on all systems.

4. `$ LINK/THREADS_ENABLE=MULTIPLE_KERNEL_THREADS`

For this command, the result on 64-bit systems is different from the result on VAX systems:

- On 64-bit systems, the command sets the `MULTIPLE_KERNEL_THREADS` bit in the image being built.
- On VAX systems, the qualifier and keyword are ignored.

5. `$ LINK/THREADS_ENABLE=(MULTIPLE_KERNEL_THREADS,UPCALLS)`

For this command, the result on 64-bit systems is different from the result on VAX systems:

- On 64-bit systems, the command sets the `UPCALLS` and `MULTIPLE_KERNEL_THREADS` bits in the image being built.
- On VAX systems, the command sets only the `UPCALLS` bit in an image being built.

/TRACE

`/TRACE` — Directs the linker to include traceback information in the image file. If you specify the `/DEBUG` qualifier, the linker includes traceback information by default, overriding the `/NOTRACE` qualifier if it is specified.

Format

`/TRACE (default)`

`/NOTRACE`

Description

Traceback is a facility that displays information from the call stack when a program error occurs. The output shows which modules were called before the error occurred.

For more information on the effects of using /TRACE combined with /DEBUG and /DSF, see /DEBUG.

Example

```
$ LINK/NOTRACE MY_PROG
```

In this example, the linker does not include traceback information in the executable image named MY_PROG.EXE.

/USERLIBRARY

/USERLIBRARY — Directs the linker to process one or more default user libraries to resolve symbolic references that remain undefined after all specified input files have been processed.

Format

```
/USERLIBRARY[(table[, ...])]
```

```
/NOUSERLIBRARY
```

```
/USERLIBRARY=ALL (default)
```

Qualifier Values

table

Specifies the logical name tables that the linker searches for default user libraries. The following keywords are the only acceptable parameter values:

Keyword	Description
ALL	Directs the linker to search the process, group, and system logical name tables for default user library definitions. This is the default.
GROUP	Directs the linker to search the group logical name table for default user library definitions.
NONE	Directs the linker not to search any logical name table; the /USERLIBRARY=NONE qualifier is equivalent to the /NOUSERLIBRARY qualifier.
PROCESS	Directs the linker to search the process logical name table for default user library definitions.
SYSTEM	Directs the linker to search the system logical name table for default user library definitions.

Description

A default user library may be an object module library or a shareable image library.

To define a default user library, you must use the DCL command `DEFINE` or `ASSIGN` to equate the logical name `LNK$LIBRARY` to the file specification of the library, because the linker looks for this logical name to determine if a default user library exists.

Further, to control access to the library, you can define `LNK$LIBRARY` in the process, group, or system logical name tables by using the `/PROCESS` qualifier, the `/GROUP` qualifier, and the `/SYSTEM` qualifier, respectively, in the `DEFINE` command.

For example, if you want the library `MY_LIB` to be your default user library, the library `GROUP_LIB` to be the default user library of everyone else in your group, and the library `ANY_LIB` to be the default user library of everyone else on the system, you would issue the following commands:

```
$ DEFINE LNK$LIBRARY DB2:[MARK]MY_LIB
$ DEFINE/GROUP LNK$LIBRARY DB2:[PROJECT]GROUP_LIB
$ DEFINE/SYSTEM LNK$LIBRARY SYS$LIBRARY:ANY_LIB
```

Note that the `GRPNAM` and `SYSNAM` privileges are required to use the `/GROUP` qualifier and the `/SYSTEM` qualifier, respectively.

If you are defining more than one library in a single logical name table, use the logical names `LNK$LIBRARY` for the first library, `LNK$LIBRARY_1` for the second library, `LNK$LIBRARY_2` for the third, and so on, up to the last possible logical name of `LNK$LIBRARY_999`. However, you must specify these logical names in numeric order without skipping any, because when the linker does not find the next sequential logical name, it stops searching in that logical name table.

The search of default user libraries proceeds as follows:

1. If you specify the `/USERLIBRARY=PROCESS` qualifier or the `/USERLIBRARY` qualifier, the linker searches the process logical name table for the name `LNK$LIBRARY`. If this entry exists, the linker translates the logical name and searches the specified library for unresolved strong references. If you exclude `PROCESS` from the table list in the `/USERLIBRARY` qualifier or if no entry exists for `LNK$LIBRARY`, the linker proceeds to step 4 (searching the group logical name table).
2. If any unresolved strong references remain, the linker searches the process logical name table for the name `LNK$LIBRARY_1` and follows the logic of step 1. If no entry exists for `LNK$LIBRARY_1`, the linker proceeds to step 4 (searching the group logical name table).
3. If any unresolved strong references remain, the linker follows the logic of step 1 for `LNK$LIBRARY_2`, `LNK$LIBRARY_3`, and so on, until it finds no match in the process logical name table, at which point it proceeds to step 4.
4. If you specify the `/USERLIBRARY=GROUP` qualifier or the `/USERLIBRARY` qualifier, the linker follows the logic in steps 1 through 3 using the group logical name table. If you exclude `GROUP` from the table list in the `/USERLIBRARY` qualifier or when any logical name translation fails, the linker proceeds to step 5.
5. If you specify the `/USERLIBRARY=SYSTEM` qualifier or the `/USERLIBRARY` qualifier, the linker follows the logic in steps 1 through 3 using the system logical name table. If you exclude `SYSTEM` from the table list in the `/USERLIBRARY` qualifier or when any logical name translation fails, the search of default user libraries is complete. By default, the linker proceeds to search the default system libraries if any unresolved references remain.

Search lists are not recognized in `LNK$LIBRARY*` logical names. Instead, use `LNK$LIBRARY_ddd` with a single library specification.

Example

```
$ LINK/USERLIBRARY=(GROUP) MY_PROG
```

In this example, the linker searches only the group logical name table to translate the logical names LNK\$LIBRARY, LNK\$LIBRARY_1, LNK\$LIBRARY_2, and so on.

/VAX (Alpha and VAX)

/VAX (Alpha and VAX) — Directs the linker to produce an OpenVMS VAX image. The default action, when neither /ALPHA nor /VAX is specified, is to create an OpenVMS VAX image on an OpenVMS VAX system and to create an OpenVMS Alpha image on an OpenVMS Alpha system.

Format

```
/VAX
```

Description

This qualifier is used to instruct the linker to accept OpenVMS VAX object, image and library files to produce an OpenVMS VAX image.

You must inform the linker where OpenVMS VAX system libraries and shareable images are located. On an OpenVMS VAX system, you use the logical name SYS\$LIBRARY to do this. On an OpenVMS Alpha system, you use the logical name VAX\$LIBRARY to do this. Therefore, if the link is to occur on an OpenVMS Alpha system, you must define the logical VAX\$LIBRARY so that it translates to the location of an OpenVMS VAX system disk residing on the system where the VAX linking is to occur.

For more information on cross-architecture linking, see Section 1.5.

Example

```
$ DEFINE VAX$LIBRARY DKB200:[VMS$COMMON.SYSLIB]
$ LINK/VAX VAX.OBJ
```

This example, performed on an OpenVMS Alpha system, shows the definition of the logical name VAX\$LIBRARY to point to an OpenVMS VAX system disk mounted on device DKB200 in the appropriate area. The qualifier tells the linker to expect the object file, VAX.OBJ, to be an OpenVMS VAX object file and to link it using the OpenVMS VAX libraries and images on DKB200, if necessary.

10.3. Option Descriptions

This section describes the linker options that you can specify in a linker options file. For information about creating and using linker options files, see Chapter 1.

You can express numeric parameters in decimal (%D), hexadecimal (%X), or octal (%O) radix by prefixing the number with the corresponding radix operator. If no radix operator is specified, the linker assumes decimal radix.

The default and maximum numeric values in this manual are expressed in decimal numbers, as are the values in any linker messages relating to these options.

Options	Supported Platform	Defaults
BASE=address	VAX	See reference description.
CASE_SENSITIVE=YES/NO	All	NO
CLUSTER=cluster-name	All	None.
COLLECT=cluster-name	All	None.
DZRO_MIN=number-of-pages	Alpha, VAX	Platform specific, see reference description.
GSMATCH=keyword,major-id,minor-id	All	See reference description.
IDENTIFICATION=id-name	All	See reference description.
IOSEGMENT=number-of-pagelets[, [NO]P0BUFS]	All	0,NOP0BUFS
ISD_MAX=number-of-image-sections	Alpha, VAX	Approximately 96
NAME=image-name	All	Name of the image
PROTECT=YES/NO	All	NO
PSECT_ATTRIBUTE=psect-name,attribute- keyword[,...]	All	None.
RMS_RELATED_CONTEXT=YES/NO	All	YES
STACK=number-of-pagelets	All	20
SYMBOL=symbol-name,symbol-value		None.
SYMBOL_TABLE=GLOBALS/ UNIVERSALS	64-bit platforms	UNIVERSALS
SYMBOL_VECTOR=(<i>[alias/]name= entry- type[,...]</i>)	64-bit platforms	None.
UNIVERSAL=symbol-name[,...]	VAX	None.

BASE= (VAX Only)

BASE= (VAX Only) — For VAX linking, specifies the base address (starting address) that you want the linker to assign to the image.

Format

BASE=address

Option Values

address

The address at which you want the image based. You can express the number in decimal (%D), octal (%O), or hexadecimal (%X) notation. If the address specified is not divisible by 512, the linker automatically adjusts it upward to the next multiple of 512, that is, to the next highest page boundary. Do not attempt to base an image linked with a larger page size (specified using the /BPAGE qualifier).

The linker bases shareable images at address 0, by default, and bases system images at address %X80000000, by default.

Description

The `BASE=` option is illegal in a link operation that produces a system image. To specify a base address for a system image, use the `/SYSTEM` qualifier.

The `BASE=` option is not supported on 64-bit systems. On x86-64 and I64 systems, you cannot create any based image. On Alpha systems, however, you can create a based executable image but you cannot create a based *shareable* image.

On Alpha systems, you can set the base address for an executable image by specifying the base address argument to the `CLUSTER= cluster-name,base-address` option. On x86-64 and I64 systems, the base address argument must be omitted in a `CLUSTER=` option.

In general, the use of based images is not recommended. The image activator, a component of the OpenVMS operating system, cannot relocate a based image in the virtual address space, which can result in conflicts in the address space: when two or more based images overlap. It can also result in fragmentation of the used virtual address space.

The linker processes the `BASE=` option by assigning the specified base address to the default cluster. If the linker creates additional clusters before it searches the default libraries, which it does if a `CLUSTER=` or `COLLECT=` option is specified or if a shareable image is explicitly specified, the following effects may occur:

- If the additional clusters are based (that is, if the `CLUSTER=` option specifies a base address or if the shareable image is a based shareable image), the linker must check that memory requirements for each based cluster do not conflict. Memory requirements conflict when more than one cluster requires the same section of address space. If they do conflict, the linker issues an error message and aborts the linking operation. If they do not conflict, the linker allocates each cluster the memory space it requests.
- If the additional clusters are not based, there will be no conflicting memory requirements. However, the linker will place each additional cluster at an address higher than that of the default cluster (because the base address of the default cluster must be the base address of the entire image). Consequently, the location of clusters (relative to each other) in the image will differ from what you would expect based on the position of each cluster in the cluster list. (Remember that the additional clusters precede the default cluster on the cluster list and that the linker typically allocates memory for clusters beginning at the first cluster on the cluster list, then the second, and so on). For more information about the linker's clustering algorithm, see Chapter 6. For more information about the linker's memory allocation algorithm, see Chapter 7.

CASE_SENSITIVE=

`CASE_SENSITIVE=` — Directs the linker to preserve the mixture of uppercase and lowercase characters used in character string arguments to linker options.

Format

`CASE_SENSITIVE=YES/NO`

`CASE_SENSITIVE=NO` (default)

Option Values

YES

Enables case sensitivity. You can use any mixture of uppercase and lowercase characters when specifying the keyword YES.

NO

Disables case sensitivity. Note that you must use only uppercase characters when specifying the keyword NO because case sensitivity is enabled and the linker does not accept mixed case in keywords.

Description

Once case sensitivity has been enabled, the linker preserves the case of all succeeding character string arguments to linker options until you explicitly disable it. When the `CASE_SENSITIVE=` option is disabled (which is the default), the linker changes all the characters in a character string to uppercase before processing the string.

Note that the `CASE_SENSITIVE=` option only affects how the linker processes arguments to linker options. When it searches object files and shareable image files for symbols that need to be resolved, the linker preserves the case used in the symbol names (created by the language compilers). Also, the names of the linker options (all the characters preceding the equal sign, as in the `NAME=` option) are unaffected by the case-sensitivity option. The linker changes all the characters in option names to uppercase characters before processing the option, even if case sensitivity has been enabled.

Carefully delimit the section of a linker options file in which you use case sensitivity to avoid unintentional side effects. For example, if you include options in the case sensitive region that accept keyword arguments, such as YES, NO, EXE, and SHR, make sure the keywords are specified using uppercase characters. Because these keywords appear after the equal sign, they are affected by case sensitivity. Similarly, character string arguments used to name a program section, cluster, or image are also affected by case sensitivity.

Symbol names issued by compilers are upper-cased by default. But you can use compiler switches to preserve mixed-case source code names. Be aware that this may result in mixed-case module or program section names as well. For example, if you have a library include statement and the module names in the library are mixed-case, then set `CASE_SENSITIVE=YES` to operate on mixed-case names in the options file.

The following excerpt from an options file illustrates how the linker changes or preserves the syntactical elements of an option line. The example contains mixed-case names that you want to preserve by setting the linker to case-sensitive mode:

```
case=Yes
My_Lib/library/include=(Add_Func, Sub_Func)
symbol_vector=(Add_Func=PROCEDURE, PAGE_COUNT=DATA)
case=NO
```

When processed by the linker, the text appears as follows:

```
CASE=YES
MY_LIB/LIBRARY/INCLUDE=(Add_Func, Sub_Func)
SYMBOL_VECTOR=(Add_Func=PROCEDURE, PAGE_COUNT=DATA)
CASE=NO
```

The case of all names to the right of the first equal sign in each option remains the same.

Note

It is recommended to switch to case sensitivity only when needed.

Example

```
$ LINK/SHAREABLE/MAP/FULL TEST, SYS$INPUT/OPTIONS
CASE_SENSITIVE=YES
NAME=ImageName
SYMBOL=OneSymbol, 1
CASE_SENSITIVE=NO
SYMBOL_VECTOR=(myroutine=PROCEDURE)
Ctrl/Z
```

In the example, the `CASE_SENSITIVE=` option with the value `YES` enables case sensitivity in the linker options file. Because case sensitivity has been enabled, the linker preserves the mix of uppercase and lowercase characters used in character string arguments to all succeeding linker options. In the example, this includes the character string `Image Name` passed to the `NAME=` option and the character string `One Symbol` passed to the `SYMBOL=` option.

Specifying the `CASE_SENSITIVE=` option with the value `NO` turns off case sensitivity. Note that you must use uppercase characters when specifying the keyword `NO`. Because case sensitivity has been disabled, the linker changes all the characters in the universal symbol `my routine` to uppercase. The following excerpt from the map file produced by this link illustrates how these identifiers were stored by the linker:

```
ImageName
OneSymbol
MYROUTINE
```

CLUSTER=

`CLUSTER=` — Directs the linker to create a cluster. (The linker groups input files into clusters before processing their contents).

Format

```
CLUSTER=cluster-name[ ,base-address[ ,pfc[ ,file-spec[ ,... ] ] ] ]
```

Option Values

cluster-name

The name you want assigned to the cluster.

base-address

The base virtual address for the cluster. If you omit the base-address value, you must still enter the comma.

On x86-64 and I64 systems, the base address must be omitted.

On Alpha systems, it is illegal to specify a base address for a cluster when creating a shareable image.

pfc (page fault cluster)

The number of pagelets read into memory by the operating system when the initial page fault occurs for a page in the cluster. If you do not specify the **pfc** parameter, the operating system uses the default value established by the system parameter PFCDEFAULT. If you omit the page fault cluster value, you must still enter the comma.

file-spec

The file you want the linker to place in the cluster. Note that you should not specify in the LINK command itself any file that you specify with the CLUSTER= option (unless you want to include two copies of the file in the final image).

Description

You can use the CLUSTER= option in the following ways:

- To control the order in which the linker processes input files
- To cause specified modules to be placed close together in virtual memory

If you do not specify the CLUSTER= option, the linker always creates at least one cluster, called the default cluster. For more information about how the linker creates clusters, see Chapter 2 (x86-64 and I64) and Chapter 6 (Alpha and VAX).

You can also create a cluster by specifying the COLLECT= option

Example

```
$ LINK MY_PROG,SYSS$INPUT/OPTIONS CLUSTER=MY_CLUSTER,,PROG2,PROG3
```

In this example, the linker creates a cluster, named MY_CLUSTER, that contains the input files named PROG2.OBJ and PROG3.OBJ.

COLLECT=

COLLECT= — Directs the linker to place the specified program section (or program sections) into the specified cluster.

Format

```
COLLECT=cluster-name  
[ /ATTRIBUTES=(RESIDENT,INITIALIZATION_CODE) ],psect-name[ , ... ]
```

Option Values**cluster-name**

Name of the cluster.

psect-name

Name of the program sections (psects) you want placed in the cluster.

Qualifier

/ATTRIBUTES

On 64-bit systems, directs the linker to mark the cluster 'cluster-name' with the indicated qualifier keyword value. Attributes set by this qualifier are only evaluated by the loader. This qualifier is used to build OpenVMS drivers. See *Writing OpenVMS Alpha Device Drivers in C* for guidelines for using this qualifier.

Qualifier Values

RESIDENT—Marks the cluster 'cluster-name' as RESIDENT so that the segment (on x86-64 and I64 systems) or image section (on Alpha systems) created from that cluster has the RESIDENT flag set. This will cause the loader to map the segment or image section into non-paged memory.

INITIALIZATION_CODE—Marks the cluster 'cluster-name' as INITIALIZATION_CODE so that the segment (on x86-64 and I64 systems) or image section (on Alpha systems) created from that cluster has the INITALCOD flagset. The initialization code will be executed by the loader. This keyword is specifically intended for use with program sections from modules SYSSDOINIT and SYSSDRIVER_INIT in STARLET.OLB.

Description

If the specified cluster does not already exist, the linker creates the cluster when it processes the COLLECT= option.

The linker sets the global (GBL) attribute for all the program sections specified, if they do not already have this attribute set. Program sections exported from a shareable image referenced in the options file with the /SHAREABLE qualifier cannot be specified in the COLLECT= option.

Example

```
LINK MY_PROG,SYSS$INPUT/OPTIONS
COLLECT=MY_CLUSTER,PSECT2,PSECT3
Ctrl/Z
```

In the example, the linker creates the cluster named MY_CLUSTER, if it does not already exist, and puts the program sections named PSECT2 and PSECT3 in the cluster.

DZRO_MIN= (Alpha and VAX)

DZRO_MIN= (Alpha and VAX) — On Alpha and VAX systems, specifies the minimum number of contiguous, uninitialized pages that the linker must find in an image section before it can extract the pages from the image section and place them in a newly created demand-zero image section. By creating demand-zero image sections (image sections that do not contain initialized data), the linker can reduce the size of images.

Format

DZRO_MIN=number-of-pages

Option Values

number-of-pages

Specifies the minimum number of contiguous pages.

For VAX linking, the linker, by default, uses a minimum of 5 pages. Each VAX page equals 512 bytes.

For Alpha linking, the linker, by default, uses a minimum of 1 page. The size of an Alpha page is CPU-specific. The initial set of Alpha systems uses an 8 KB page. The page size used is that of the current link operation. (See the /BPAGE qualifier).

The number of pages must be equal to or greater than the value specified in the parameter.

Description

A demand-zero image section contains uninitialized, writable pages, which do not occupy physical space in the image file on disk, but which, when accessed during program execution, are allocated memory and initialized with binary zeros by the operating system. For more information about demand-zero compression on Alpha and VAX, see Chapter 7.

When specifying a value for this option, be aware that a low value (less than the default value) increases the likelihood that the linker will encounter the required number of contiguous, uninitialized pages and thus may increase the number of demand-zero image sections the linker creates for the image (depending on the contents of the object modules). While this can reduce the size of the image file on disk, it can also decrease the image's paging performance during execution. Conversely, a value higher than the default value decreases the likelihood that the linker will encounter the required number of contiguous, uninitialized pages; decreases the number of demand-zero image sections the linker creates; and may increase the size of the image file on disk but provide better paging performance during execution.

The linker stops creating demand-zero image sections when the total number of image sections in the image reaches the value specified by the ISD_MAX= option or the default value. For more information, see the description of the ISD_MAX= option.

The DZRO_MIN= option is illegal in a link operation that produces a system image.

Example

```
$ LINK MY_PROG, SYS$INPUT/OPTIONS
DZRO_MIN=15
Ctrl/Z
```

In this example, the value of the DZRO_MIN= is set to 15.

GSMATCH=

GSMATCH= — Sets match control parameters for a shareable image and specifies the match algorithm. This option allows you to control whether executable images that link with a shareable image must be relinked each time the shareable image is updated and relinked.

Format

GSMATCH=keyword, major-id, minor-id

GSMATCH=EQUAL, link-time-derived-major-id, link-time-derived-minor-id
(default)

Option Values

keyword

Identifies the match algorithm used by the image activator. Specify one of the following keywords:

Keyword	Meaning
EQUAL	<p>Directs the image activator to allow the image to map to the referenced shareable image when one condition is met:</p> <ul style="list-style-type: none"> the major and minor ID for the shareable image, as saved at link time in the image file, are equal to the IDs found in the actual shareable image file at activation time.
LEQUAL	<p>Directs the image activator to allow the image to map to the referenced shareable image when two conditions are met:</p> <ul style="list-style-type: none"> the major ID for the shareable image, as saved at link time in the image file, is equal to the major ID found in the actual shareable image file at activation time the minor ID for the shareable image, as saved at link time in the image file, is less than or equal to the minor ID found in the actual shareable image file at activation time.
ALWAYS	<p>Directs the image activator to unconditionally allow the image to map to the referenced shareable image:</p> <ul style="list-style-type: none"> regardless of the values of the major and minor ID for the shareable image, as saved at link time in the image file, and the values of the IDs found in the actual shareable image file at activation time. <p>Note that you must still specify values for the major ID and minor ID parameters to satisfy the requirements of the option syntax.</p>

major-id

Specifies the major identification number.

minor-id

Specifies the minor identification number.

When a shareable image is created without specifying a `GSMATCH=` option, the linker by default creates one. It sets the `EQUAL` match control and uses portions of the image creation time, as a binary value, for the major and minor IDs. In general this is sufficient to set a unique value for the IDs each time the shareable image is linked. On x86-64 and I64 systems, the linker uses bits 40 through 54 of the binary time value for the major ID and bits 8 through 39 for the minor ID. On Alpha and VAX systems, the linker uses bits 32 through 46 of the binary time value for the major ID and bits 16 through 31 for the minor ID.

Description

The `GSMATCH=` option causes a major identification parameter (`major-id`), a minor identification parameter (`minor-id`), and a match control keyword to be stored in the shareable image file. The control keyword together with the IDs is called the `GSMATCH` information.

When an image is linked with a shareable image, together with the reference to the shareable image its GSMATCH information is saved in the image file.

When the image is run, the image activator encounters the reference to the shareable image. At this time, the image activator compares the GSMATCH information as saved in the image with the GSMATCH information retrieved from the actual shareable image. The implementation details on different systems are slightly different, the mechanism and its effects are the same.

The following information describes the GSMATCH mechanism for an executable image linked against a shareable image. "Executable" is used to clearly differentiate between the referencing image and the referenced image, the shareable image. However, in general any image, executable or shareable, can be linked against a shareable image and the described mechanism applies.

- On x86-64 and I64 systems, the GSMATCH= option causes a major identification parameter (major-id), a minor identification parameter (minor-id), and a match control keyword to be stored in the dynamic segment of the shareable image. It is the DT_VMS_IDENT field which holds this information.

When an executable image is linked with a shareable image, the dynamic segment of the executable image contains the name of the shareable image. This information is saved in the field DT_NEEDED. The name is accompanied by the GSMATCH information of the shareable image, taken at link time. This information is saved in the field DT_VMS_NEEDED_IDENT.

When the executable image is run and the image activator begins processing the dynamic segment of the executable image, the image activator encounters the name of the shareable image. At that time, the image activator looks up the shareable image file based on this name, either as a logical name, pointing to a file, or as a file name in the directory SYSS\$LIBRARY. If an image file was found, the image activator continues to process the GSMATCH information.

- On Alpha and VAX systems, the GSMATCH= option causes a major identification parameter (major-id), a minor identification parameter (minor-id), and a match control keyword to be stored in the image header of the shareable image.

When an executable image is linked with a shareable image, the image header of the executable image contains an image section descriptor (ISD) for the shareable image (as well as an ISD for each image section in the image). The ISD for the shareable image contains a major ID, minor ID, and match control keyword, which the linker copies from the shareable image at link time.

When the executable image is run and the image activator begins processing the ISDs in the image header of the executable image, the image activator encounters the ISD for the shareable image. As such, the image activator looks up the shareable image file based on its name, either as a logical name, pointing to a file, or as a file name in the directory SYSS\$LIBRARY. If an image file was found, the image activator compares the image section name in the ISD to the image section name in the image header of the current shareable image file. If the image section names do not match, the image activator does not allow the executable image to map to the shareable image, regardless of the GSMATCH parameters. If the image section names match, the image activator continues to process the GSMATCH information.

- To process the GSMATCH information, the image activator compares the major ID parameters. If they do not match, the image activator does not allow the executable image to map to the shareable image unless GSMATCH=ALWAYS has been specified.

If the major ID parameters match, the image activator compares the minor ID parameters. If the relation between the minor ID parameters does not satisfy the relation specified by the match

control keyword, the image activator does not allow the executable image to map to the shareable image. Then the image activator issues an error message stating that the executable image must be relinked.

The match control keyword must be the same in both the shareable and executable image files. If it is different, then the more restrictive match is used. For example, if a shareable image is linked with ALWAYS, and an executable image contains EQUAL (from an earlier version of the shareable image), then the test at activation time will be EQUAL.

Thus, to create an upwardly compatible shareable image, increment only the value of the minor ID and leave unchanged the value of the major ID. If the match control keyword is LEQUAL, the executable image that links against it will run. (If the major ID is changed, executable images can never map to the shareable image unless ALWAYS is specified). By using this convention, you can ensure that executable images that linked with an older version of the shareable image can map to the newer version.

On Alpha and VAX systems, the linker uses the same GSMATCH mechanism to check the compatibility of the information in a shareable image library and the shareable image file. For more information, see the description of the /LIBRARY qualifier in /LIBRARY.

The image activator verifies the index (on x86-64 and I64 systems) or offset (on Alpha systems) of a referenced symbol in a shareable image; the index or offset is then confirmed if it is within the symbol vector.

This additional step makes it possible to avoid relinking of some images. To illustrate the feature, consider a shareable image with an exported routine MY_ADD, created with a SYMBOL_VECTOR=(MY_ADD=PROCEDURE) option. Consider also an updated version of the shareable image with an improved MY_ADD routine but also with an additional routine MY_SUB. That is, a shareable image created with a SYMBOL_VECTOR=(MY_ADD=PROCEDURE,MY_SUB=PROCEDURE) option.

The usual way to make such a change upward compatible is by changing the minor ID in the GSMATCH= option. (This method is also the required way on VAX). Now consider linking your application, which only calls MY_ADD, with the new shareable image and shipping it to a customer site, where only the old shareable image is available. This image will not be activated with the old shareable image because of the GSMATCH mechanism. It does not matter that the new symbol is not referenced and that the application - if activated - would correctly work. To resolve this GSMATCH conflict, the application image needs to be relinked with the old shareable image at the customer site or the updated shareable image needs to be shipped with the application.

On 64-bit systems, this condition can be avoided. By using an unchanged minor ID in the GSMATCH= option, the updated shareable image is downward compatible. Again, the application image only uses the old interface (MY_ADD, in this example). Such images, although linked against the new shareable image, can be activated with the old shareable image. Any application image using the additional interface (MY_SUB, in this example) will not be activated with the old shareable image; the check fails, the index or offset of the new symbol is not within the symbol vector of the old shareable image. The image activation aborts with the secondary message -LOADER-E-BADSVINDX (on x86-64 and I64 systems) or with the error message %IMGACT-F-SYMVECMIS (on Alpha systems).

In such a situation, where you only add interfaces at the end of the symbol vector, you can safely leave the minor ID of the updated shareable image the same and rely on the check of the image activator.

Examples

1.

```
$ LINK/SHAREABLE MY_SHARE, SYS$INPUT/OPTIONS
GSMATCH=LEQUAL, 1, 1000
Ctrl/Z
```

In this example, the `GSMATCH=` option sets the major and minor identification numbers for this shareable image.

2.

```
$ LINK/SHAREABLE MY_SHARE, SYS$INPUT/OPTIONS
GSMATCH=LEQUAL, 1, 1001
Ctrl/Z
```

In this example, the shareable image created in the previous example is relinked and the minor identification number is incremented. Note that executable images that link with the new version cannot map to the old version, whereas executable images that link with the old version can map to the new version.

3.

```
$ LINK/SHAREABLE MY_SHARE, SYS$INPUT/OPTIONS
GSMATCH=ALWAYS, 0, 0
Ctrl/Z
```

By specifying the keyword `ALWAYS`, an executable image can run with any version of the shareable image (newer or older).

IDENTIFICATION=

`IDENTIFICATION=` — Sets the image-id field in the image file. The image identification usually holds a version number of the image, but can be used for any text to identify the generated image.

Format

`IDENTIFICATION=id-name`

Option Values

id-name

The maximum length of the identification character string is 15 characters. If the string contains characters other than uppercase and lowercase A through Z, the numerals 0 through 9, the dollar sign, and the underscore, enclose it in quotation marks.

Description

On x86-64 and I64 systems, the identification string is saved in the NOTE section. On Alpha and VAX systems, the text is saved in the image header.

When the `IDENTIFICATION=` option is not specified, the linker always creates and saves a default identification. Because object modules have identification strings as well, the linker tries to use them for the image. If that fails, the linker uses the file type, explicitly or implicitly specified for the image file. In such a case you may see the identification ".EXE".

For the default image ID, the linker takes the first non-empty identification string from an object module, when processing the input files. Thereafter, the default image ID is only changed, if the linker encounters an object module that provides the transfer address. (A transfer address is the main entry point for the image). The providing module is seen as the main contributor and therefore should determine the default image ID.

Because shareable images normally do not have a main entry point, the default image ID usually remains as the ID of the first object module processed.

On Alpha and VAX systems, when linking system image with /SYSTEM and /NOHEADER, the IDENTIFICATION= option is accepted but is not saved in the image file.

Example

```
$ LINK /EXECUTABLE=IA64_LINKER LINKER/OPTIONS, SYS$INPUT/OPTIONS
IDENTIFICATION="I02-31"
Ctrl/Z
```

In this example, it is shown how a version number of the I64 linker is specified with the IDENTIFICATION= option. With the Analyze utility, the image can be identified as the second major release of the I64 linker with version 31.

IOSEGMENT=

IOSEGMENT= — Specifies the amount of space to be allocated for the image I/O segment, which holds the buffers and OpenVMS RMS control information for all files used by the image.

Format

```
IOSEGMENT=number-of-pagelets[ , [NO]P0BUFS ]
```

```
IOSEGMENT=0, NOP0BUFS (default)
```

Option Values

number-of-pagelets

Specifies the number of pagelets (512-byte units) to be allocated for the image I/O segment. By default, the operating system uses the value set by the IMGIOCNT system parameter to determine the size of the image I/O space.

[NO]P0BUFS

By default, the operating system allocates the I/O segment in the P1 region of the process space and, if additional space is needed, at the end of the P0 region. If you specify NOP0BUFS, you deny OpenVMS RMS additional pages in the P0 region.

Description

Specifying the value of **number-of-pagelets** to be greater than the value of IMGIOCNT ensures the contiguity of P1 address space, providing that OpenVMS RMS does not require more pages than the value specified. If OpenVMS RMS requires more pagelets than the value specified, the pagelets in the P0 region would be used (by default).

Note that if you specify NOP0BUFS and if OpenVMS RMS requires more pagelets than have been allocated for it, OpenVMS RMS issues an error message.

Example

```
$ LINK MY_PROG, SYS$INPUT/OPTIONS
IOSEGMENT=100, P0BUFS
Ctrl/Z
```

ISD_MAX= (Alpha and VAX)

ISD_MAX= (Alpha and VAX) — On Alpha and VAX systems, specifies the maximum number of image sections allowed in the image.

Format

```
ISD_MAX=number-of-image-sections
```

```
ISD_MAX=96 (default, approximate value)
```

Option Values

number-of-image-sections

The maximum number of image sections that may be created. You can specify the value in hexadecimal (%X), decimal (%D), or octal (%O) radix. The default is decimal radix.

Description

This option is used to control the linker's creation of demand-zero image sections by imposing an upward limit on the number of total image sections. Thus, if the linker is creating demand-zero image sections, and if the total number of image sections reaches the ISD_MAX= value, demand-zero image section creation ceases at that point. For more information about how the linker creates demand-zero image sections, see Section 7.4.3.

The ISD_MAX= option may be specified only in a link operation that produces an executable image. The ISD_MAX= option is illegal in a link operation that produces either a shareable or a system image.

The default value for ISD_MAX= is approximately 96. Note that any value you specify is also an approximation. The linker determines an exact ISD_MAX=value based on characteristics of the image, including the different combinations of section attributes. The exact value, however, will be equal to or slightly greater than what you specify; it will never be less.

Example

```
$ LINK MY_PROG, SYS$INPUT/OPTIONS
ISD_MAX=126
Ctrl/Z
```

NAME=

NAME= — Sets the image-name field in the image file. The image name is used on Alpha and VAX systems to resolve self-references in the shareable image list.

Format

```
NAME=image-name
```

Format

```
image-name
```

A character string up to 39 characters in length. If the name contains characters other than uppercase and lowercase A through Z, the numerals 0 through 9, the dollar sign, and the underscore, enclose it in quotation marks.

Description

If the NAME= option is not specified, the string specified with /SHAREABLE or /EXECUTABLE is used for the image-name field. If no string was specified to /SHAREABLE or /EXECUTABLE, the name of the first module processed is used.

The NAME= option does not affect the name of the image file.

The image-name field is not used by the linker or librarian.

For Alpha and VAX linking, if a shareable image references its own exported symbol (on Alpha systems, created with a SYMBOL_VECTOR clause that contains an ALIAS keyword), the linker always uses the string from the NAME= option to name the image in the shareable image list. When using a different name than the image file, the to be generated shareable image will not show in its own shareable image list. The image-name field will not change when the image file is renamed. This way the image activator can always resolve a self-reference.

On x86-64 and I64 systems, self-references is expressed differently. There is no entry in the shareable image list for the current image. Self-references are referred to with a special index value into the shareable image list (-1 in the DT_VMS_FIXUP_NEEDED field) that results in a set of DT_NEEDED entries. However, the NAME= option is supported for compatibility reasons.

The following conventions describe the various names that apply to an image:

- File name — Images are given an image file specification (for example, FOO.EXE) that can be changed with the DCL command RENAME.
- Image name — The image name as specified with the NAME= option and stored in the image file. This name can be different than the image file specification name. However, if you do not use the NAME= option, the name defaults to the image file specification name. The Analyze utility displays this name as the "Image name". Once written to the image file, you cannot change this name.
- Global Symbol Table Name — An additional name for the image is associated with the global symbol table (GST) and stored in the image, for example, in x86-64 and I64 images it is in a note of type NT_VMS_GSTNAM. The linker sets this name to be the same as the image file specification name. This name is used by the Librarian when you insert an image into an image library. It is displayed by the Analyze utility as the Global Symbol Table Name. Once written to the image file, you cannot change this name.

Example

```
$ LINK MY_PROG, SYS$INPUT /OPTIONS
NAME=MY_IMAGE
Ctrl/Z
```

PROTECT=

PROTECT= — Specifies that the segments (on x86-64 and I64 systems) or image sections (on Alpha and VAX systems) in one or more clusters in a shareable image should be protected from user-mode or supervisor-mode write access.

Format

PROTECT=YES/NO

PROTECT=NO (default)

Option Values

YES

Enables protection for all the clusters defined in subsequent lines in the options file by the CLUSTER= option or the COLLECT= option, up to a line containing another PROTECT= option.

NO

Disables protection for all clusters specified on subsequent lines of a linker options file by the CLUSTER=option or the COLLECT= option, up to the line containing another PROTECT=YES option. Protection is disabled by default.

Description

This option is used to protect segments or image sections that contain privileged code or data in shareable images that implement user-written system services (called privileged shareable images). For more information about creating user-written system services, see the *VSI OpenVMS Programming Concepts Manual*.

Note that the protection applies to the segments and image sections the linker creates from the cluster, *not* the cluster itself. A cluster is an internal construct the linker uses to organize how it processes input files. The linker communicates the actual memory requirements of an image, including its protection, to the image activator as segment or image section specifications.

If the entire shareable image needs to be protected,specify the /PROTECT qualifier.

On x86-64 and I64 systems, it is recommended to protect the whole image with the /PROTECT qualifier; see Section 4.4).

Example

```
$ LINK/SHAREABLE=MY_SHARE SYS$INPUT/OPTIONS
PROTECT=YES
CLUSTER=A, , MOD1,MOD2
SYMBOL_VECTOR=( ENTRY=PROCEDURE)
PROTECT=NO
CLUSTER=B, , MOD3
COLLECT=A, PSECTX, PSECTY, PSECTZ
Ctrl/Z
```

In this example, the segments or image sections, created from the modules MOD1 and MOD2 in cluster A are protected; the segments or image sections, created from the module MOD3 in cluster B are not protected; the segments or image sections into which the program sections PSECTX, PSECTY, and PSECTZ are collected in cluster A are protected. Note that other linker options, such as the SYMBOL_VECTOR= option in the example, are not affected. Please note, the symbol vector, which is a NOWRT program section by default, is not protected with this scheme. Its program section is collected onto the default cluster.

PSECT_ATTRIBUTE=

PSECT_ATTRIBUTE= — Specifies the attributes of a program section.

Format

PSECT_ATTRIBUTE=psect-name, attribute-keyword[, ...]

Option Values

psect-name

Specifies the name of the program section whose attributes you want to set. The name may be a character string up to 31 characters in length.

attribute-keyword

One or more attributes, identified by a keyword or a number, separated by commas. For a complete description of the program section attributes see Section 3.2 (x86-64 and I64) and Section 7.2 (Alpha and VAX).

Settable attributes

- Alignment — Specify the alignment of the program section as an integer that represents the power of 2 required to generate the desired alignment or specify a keyword, if available.

Power of 2	Keyword	Meaning
0	BYTE	Alignment on byte boundaries.
1	WORD	Alignment on word boundaries.
2	LONG	Alignment on longword boundaries.
3	QUAD	Alignment on quadword (8-byte) boundaries.
4	OCTA	Alignment on octaword (16-byte) boundaries.
5 ¹	HEXA	Alignment on hexadecimal word (32-byte) boundaries.
6 ¹	—	Alignment on 64-byte boundaries.
7 ¹	—	Alignment on 128-byte boundaries.
8	—	Alignment on 256-byte boundaries.
9	—	Alignment on 512-byte boundaries.
13	—	Alignment on 8 KB boundaries.
14	—	Alignment on 16 KB boundaries.
15	—	Alignment on 32 KB boundaries.
16	—	Alignment on 64 KB boundaries.
—	PAGE	Alignment on the default target page size, see the /BPAGE qualifier

¹x86-64 and I64 specific

- ALLOC_64BIT/NOALLOC_64BIT (x86-64 and I64) — Allocate section in P2 space
- EXE/NOEXE — Executability

- GBL/LCL — Global/Local
- MOD (64-bit systems) — Unmodified
- OVR/CON — Overlaid/Concatenated
- PIC/NOPIC (Alpha and VAX) — Position Independence
- REL/ABS — Relocatable/Absolute
- SHORT (I64 only) — Short Data
- SHR/NOSHR — Shareability
- SOLITARY — Solitary
- VEC/NOVEC — Protected Vectors
- WRT/NOWRT — Writability

Description

Attributes not specified in a PSECT_ATTRIBUTE= option remain unchanged.

If you specify a program section alignment that is greater than the target page size, the linker issues a warning and adjusts the alignment to be equal to the target page size.

By default, the linker aligns program sections, at a minimum, on the boundary specified by the compiler.

The PSECT_ATTRIBUTE= option aligns the program section on the specified boundary which should be equal to or greater than that which the compiler specified. The linker does not align each individual contribution to the section; rather, it aligns the total program section. The linker follows the compiler's alignment specification when it aligns each individual contribution.

Do not specify a smaller program section alignment with the PSECT_ATTRIBUTE=option than the alignment that the compiler gave to the program section.

On x86-64 and I64 systems, if you specify a smaller alignment for a program section than any compiler-assigned alignment from all contributions to this program section, the linker issues a warning. For example:

```
$ LINK HI, SYS$INPUT/OPTIONS
PSECT_ATTRIBUTE=$LITERAL$, BYTE
Ctrl/Z
%ILINK-W-CONFALGN, PSECT option alignment (1) less than compiler
assigned (16);
alignment ignored
    section: $LITERAL$
    module: HI
    file: DISK$USER:[JOE]HI.OBJ;3
```

Please note, the alignment number in the linker message indicates a multiple-of-bytes alignment, where 1 is a byte alignment and 16 is an octaword alignment.

On Alpha and VAX systems, the linker inappropriately aligns the program section on the boundary that you specified ("byte", in the preceding code example), and places all the contributions to that

program section (from other modules you might have linked with "HI", in the example) on boundaries that were not specified by the compiler. The linker does not issue an error message.

Example

```
$ LINK MY_PROG, SYS$INPUT/OPTIONS
PSECT_ATTRIBUTE=MY_CONST, NOWRT
Ctrl/Z
```

In this example, the linker protects the program section MY_CONST from write access and leaves all other attributes of MY_CONST unchanged.

RMS_RELATED_CONTEXT=

RMS_RELATED_CONTEXT= — Enables or disables RMS related name context processing. This is also known as file specification "stickiness." The default is to have RMS related name context processing enabled. This default applies at the start of each options file regardless of the setting in a previous options file. The related name context itself (the collection of data structures RMS maintains to supply the most recently specified fields) does not carry over from one linker options file to the next. That is, previously specified fields in the previous options file are not used to fill in absent fields for file specifications in the current options file.

Format

```
RMS_RELATED_CONTEXT=YES/NO
```

```
RMS_RELATED_CONTEXT=YES (default)
```

Option Values

YES

Enables RMS related name context processing. If an option **RMS_RELATED_CONTEXT=NO** is in effect, its saved related name context is restored. If RMS related name context processing is already enabled, this option has no effect.

RMS related name context processing is enabled by default. Therefore command line file specifications are processed with RMS related name context. Also, RMS related name context processing is enabled at the start of each options file. The related name context is limited to a single options file. That is, the saved related name context is cleared at the start of each options file.

NO

Disables RMS related name context processing. If an option **RMS_RELATED_CONTEXT=YES** is in effect, the current name context is saved for a possible future **RMS_RELATED_CONTEXT=YES** option. If RMS related name context processing is already disabled, specifying **RMS_RELATED_CONTEXT=NO** has no effect.

Description

When RMS related name processing is enabled (by default and at the beginning of each options file), file specifications that do not have all fields of the file specification present will have the missing fields replaced with the corresponding fields most recently specified in earlier file specifications.

When disabled, fields in the file specification that are absent are not replaced with corresponding fields of previous file specifications.

When the RMS related name context processing is switched from enabled to disabled, the current related name context is saved. Vice versa, if the RMS related name context processing is switched from disabled to enabled, the saved related name context is restored.

In combination with logical names and search lists, determining a missing input file with RMS related name context processing enabled may take long. To the user the link operations seems to hang or to loop. To identify such a situation and to resolve it by determining which file is missing, follow these steps:

1. Specify SY\$INPUT/OPTIONS in the LINK command and press Return. (The linker waits for you to enter option clauses for the link operation from the terminal).
2. Enter the option clauses and include the following information:
 - On the first line, specify: RMS_RELATED_CONTEXT=NO.

With the RMS_RELATED_CONTEXT= option set to NO, any missing file listed in this options file generates an immediate "file not found" message.

 - On subsequent lines, specify the files to be linked, using full file specifications in the form disk:[dir]filename.ext for every file. Full file specifications are required because when you specify RMS_RELATED_CONTEXT=NO, file name "stickiness" is disabled.
3. Press Ctrl/Z.

Example

1. \$ LINK DSK:[TEST]A.OBJ, B.OBJ

In this example the RMS related name context processing is enabled by default. The specified input file B.OBJ gets the name context DSK:[TEST] from the previous input file DSK:[TEST]A.OBJ.

2. \$ LINK/EXECUTABLE=A.EXE SY\$INPUT/OPTIONS
 RMS_RELATED_CONTEXT=NO
 DSK:[TEST]A.OBJ, DSK:[TEST]B.OBJ
 Ctrl/Z

In this example the RMS related name context processing is disabled. The full file specifications for both object modules are required. The link operation is the same as in the previous example.

3. \$ DEFINE DSKD\$ WORK4:[TEST.LINKER.OBJ.] ❶
 \$ DEFINE RESD\$ ROOT\$, ROOT2\$, ROOT3\$,
 ROOT4\$, ROOT5\$, DISK_READ\$:[SYS.]
 \$ DEFINE ROOT\$ WORK4:[TEST.PUBLIC.TEST]
 \$ DEFINE ROOT2\$ WORK4:[TEST.LINKER.]
 \$ DEFINE ROOT3\$ WORK4:[TEST.UTIL32.]
 \$ DEFINE ROOT4\$ WORK4:[TEST.PUBLIC.]
 \$ DEFINE ROOT5\$ WORK4:[TEST.PUBLIC.TMP]
 \$ LINK/MAP/FULL/CROSS_REFERENCE/EXECUTABLE=ALPHA.EXE RESD\$:[TMPOBJ]A.OBJ,-
 _ \$ RESD\$:[SRC]B.OBJ,C,DSKD\$:[OBJ]D.OBJ,E,RESD\$:[TMP SRC]F.OBJ,-
 _ \$ RESD\$:[TEST]G.OBJ,RESD\$:[SRC.OBJ]H,RESD\$:[COM]DOES_NOT_EXIST.OBJ
 Ctrl/T ❷
 NODE6::_FTA183: 15:49:46 LINK CPU=00:02:30.04 PF=5154 IO=254510 MEM=134
 Ctrl/T
 NODE6::_FTA183: 15:49:46 LINK CPU=00:02:30.05 PF=5154 IO=254513 MEM=134
 Ctrl/T

```

NODE6::_FTA183: 15:50:02 LINK CPU=00:02:38.27 PF=5154 IO=268246 MEM=134
Ctrl/T
NODE6::_FTA183: 15:50:02 LINK CPU=00:02:38.28 PF=5154 IO=268253 MEM=134
Ctrl/T
NODE6::_FTA183: 15:50:14 LINK CPU=00:02:44.70 PF=5154 IO=278883 MEM=134

```

In this example, the linker appears to loop. The file `DOES_NOT_EXIST.OBJ`, as included in the argument list, does not exist. An `RMS_RELATED_CONTEXT=` option is not specified (and, therefore, defaults to `YES`). With multiple logical names and a search list for the logical `RESD$`, determining that this file is missing takes very long.

- ❶ These commands define logical names and equivalents.
- ❷ Each time you press `Ctrl/T`, the CPU and IO values increase, but the MEM and PF values do not, indicating that `LIB$FIND_FILE` has been called with RMS related name context.

```

$ DEFINE DSKD$ WORK4:[TEST.LINKER.OBJ.]
$ DEFINE RESD$ ROOT$, ROOT2$, ROOT3$, ROOT4$, ROOT5$, DISK_READ$:[SYS.]
$ DEFINE ROOT$ WORK4:[TEST.PUBLIC.TEST.]
$ DEFINE ROOT2$ WORK4:[TEST.LINKER.]
$ DEFINE ROOT3$ WORK4:[TEST.UTIL32.]
$ DEFINE ROOT4$ WORK4:[TEST.PUBLIC.]
$ DEFINE ROOT5$ WORK4:[TEST.PUBLIC.TMP.]
$ LINK/MAP/FULL/CROSS_REFERENCE/EXECUTABLE=ALPHA.EXE SYS$INPUT/OPTIONS
  RMS_RELATED_CONTEXT=NO
  RESD$:[TMPOBJ]A.OBJ,RESD$:[SRC]B.OBJ,RESD$:[SRC]C,DSKD$:[OBJ]D.OBJ
  DSKD$:[OBJ]E,RESD$:[TMP SRC]F.OBJ,RESD$:[TEST]G.OBJ
  RESD$:[SRC.OBJ]H,RESD$:[COM]DOES_NOT_EXIST.OBJ
Ctrl/Z

%LINK-F-OPENIN, error opening DISK_READ$:[SYS.][COM]DOES_NOT_EXIST.OBJ; as input
  -RMS-E-FNF, file not found
$

```

In this example, using an options file with `RMS_RELATED_CONTEXT` set to `NO`, causes the link operation to finish immediately because it determines quickly the missing file.

STACK=

`STACK=` — Specifies the size of the user-mode stack.

Format

`STACK=number-of-pagelets`

`STACK=20` (default)

Format

number-of-pagelets

Specifies the size of the stack in pagelets (512-byte units).

Description

If you do not specify the `STACK=` option, the linker allocates 20 pagelets (512-byte units) for the user-mode stack. Note that the stack is usually located at the lower end of the used P1 space and that additional space for the user-mode stack is automatically allocated — growing into unused, lower P1 space, if needed, during program execution. The `STACK=` option is primarily used to set the stack size for images that are linked with the `/POIMAGE` qualifier, where the stack growth is limited by the mapped images. Depending on the layout of the images, the stack can grow into a writable data

segment (on x86-64 and I64 systems) or image section (on Alpha and VAX systems) and corrupt the data. The `STACK=` option may be specified only in a link operation that produces an executable image. Shareable images share the stack with the executable image.

SYMBOL=

`SYMBOL=` — Directs the linker to define an absolute global symbol with the specified name and assign it the specified value. You can use this option to specify a link-time constant.

Format

`SYMBOL=symbol-name , symbol-value`

Option Values

`symbol-name`

A character string up to 31 characters in length.

`symbol-value`

The value you want to assign to the symbol. An absolute global symbol has a fixed numeric value and is therefore not relocatable. Thus, the value must be a number.

On x86-64 and I64 systems, the numeric value is a 64-bit value.

Description

The definition of a symbol specified by the `SYMBOL=` option constitutes the first definition of that symbol, and it overrides subsequent definitions of the symbol in input object modules. In particular:

- If the symbol is defined as relocatable in an input object module, the linker ignores this definition, uses the definition specified by the `SYMBOL=` option, and issues a warning message.
- If the symbol is defined as absolute in an input object module, the linker ignores this definition and uses the definition specified by the `SYMBOL=` option; however, it does not issue a warning message.

For more information about symbol resolution, see Chapter 2 (x86-64 and I64) and Chapter 6 (Alpha and VAX).

Note

The `SYMBOL=` option cannot be used to define a symbol used in the `SYMBOL_VECTOR=` option or the `UNIVERSAL=` option.

Example

```
$ LINK MY_PROG , SYS$INPUT /OPTIONS
SYMBOL=ITERATIONS , 15
Ctrl/Z
```

In this example, the program `MY_PROG` contains a loop, which is performed `ITERATIONS` times. In this link operation, for the image `MY_PROG`, the value of `ITERATIONS`, even if defined in an object module, is set to 15.

SYMBOL_TABLE= (64-Bit Systems)

SYMBOL_TABLE= (64-Bit Systems) — Specifies whether the linker should include global symbols in a symbol table file produced in a link operation in which a shareable image is created. By default, the linker includes only universal symbols in a symbol table file associated with a shareable image.

Format

```
SYMBOL_TABLE=GLOBALS/UNIVERSALS
```

```
SYMBOL_TABLE=UNIVERSALS (default)
```

Option Values

GLOBALS

Specifies that the linker should include global symbols and universal symbols in the symbol table file associated with the shareable image.

UNIVERSALS

Specifies that the linker should include only universal symbols in the symbol table file associated with the shareable image.

Description

This option may be specified only in the creation of a shareable image. Note that the symbol table file affected by this option cannot be used as input in a subsequent link operation but is intended to be used with the OpenVMS System Dump Analyzer utility (SDA) as an aid to debugging.

Example

```
$ LINK/SHAREABLE/SYMBOL_TABLE MY_SHARE,SYS$INPUT/OPTIONS
GSMATCH=LEQUAL,1,1000
SYMBOL_VECTOR=(PROC1=PROCEDURE,-
                PROC2=PROCEDURE,-
                PROC4=PROCEDURE)
SYMBOL_TABLE=GLOBALS
Ctrl/Z
```

In the example, the symbols PROC1, PROC2, and PROC4 are declared as universal symbols. Normally, these symbols would be the only symbols to appear in a symbol table file associated with this shareable image. (The symbol table file duplicates the global symbol table of the shareable image). However, because the SYMBOL_TABLE=GLOBALS option is specified, the linker also puts all the global symbols in the shareable image into the symbol table file. You must specify the /SYMBOL_TABLE qualifier to obtain a symbol table file.

SYMBOL_VECTOR= (64-Bit Systems)

SYMBOL_VECTOR= (64-Bit Systems) — Declares universal symbols in shareable images.

Format

```
SYMBOL_VECTOR=( [alias/]name=entry-type[ , ... ] )
```

Option Values

alias

Optionally specifies an alias name for the symbol you want to declare universal. When specified, the alias name appears in the global symbol table (GST) of the image and values associated with the name specified in the *symbol-name* parameter appear in the symbol vector of the image.

Note that you can specify alias names only for symbol vector entries declared using the DATA or PROCEDURE keywords. For more information about symbol vector entry types, see the following table.

name

Specifies the name of the symbol or the name of a program section in the shareable image that you want to declare universal.

entry-type

Specifies the type of the symbol vector entry. The following table lists the types of symbol vector entries supported by the linker along with the keyword you use to specify them:

Keyword	Function
DATA ¹	Creates a symbol vector entry for data (relocatable or constant). The linker creates an entry for the symbol in the GST of the shareable image.
PROCEDURE ¹	Creates a symbol vector entry for a procedure and creates an entry for the symbol in the GST of the shareable image.
PRIVATE_DATA	Creates a symbol vector entry for data; however, the linker does not create an entry for the data in the GST of the shareable image. Thus, the symbol is not available for other modules to link against.
PRIVATE_PROCEDURE	Creates a symbol vector entry for a procedure; however, the linker does not create an entry for the procedure in the GST of the shareable image. Thus, the symbol is not available for other modules to link against.
PSECT	Creates a symbol vector entry for a program section and creates an entry for the program section in the GST of the shareable image. ²
SPARE	Use this keyword to create a placeholder. SPARE allows you to preserve the order of the symbol vector entries when you need to create an upwardly compatible shareable image. The SPARE keyword is used alone; it is not preceded by a symbol name and equal sign.

¹You can specify an alias name for this type of symbol vector entry.

²Although not a symbol, the name of an exported program section is part of the GST, which implements the public interface of the shareable image.

Description

The linker creates an entry in the GST of a shareable image for each name listed in the SYMBOL_VECTOR= option, unless the symbol is declared private, the /NOGST qualifier is specified, or the symbol is the internal name for an alias. Symbols and program sections that appear in the GST of a shareable image are available for external modules to link against. For more information about creating and using shareable images, see Chapter 4 (x86-64 and I64) and Chapter 8 (Alpha).

Example

```
$ LINK/SHAREABLE MY_SHARE, SYS$INPUT/OPTIONS
GSMATCH=LEQUAL, 1, 1000
SYMBOL_VECTOR=(MY_ADD=PROCEDURE, -
                MY_SUB=PROCEDURE, -
                SPARE, -
                SPARE, -
                MY_DATA=DATA, -
                MY_DATA_PSECT=PSECT)

Ctrl/Z
```

This example creates a symbol vector with entries for procedures, data, and a program section.

```
$ LINK/SHAREABLE MY_SHARE, SYS$INPUT/OPTIONS
GSMATCH=LEQUAL, 1, 1001
SYMBOL_VECTOR=(MY_ADD=PRIVATE_PROCEDURE, -
                DEPRECATED_SUB=PRIVATE_PROCEDURE, -
                MY_ADD/UPDATED_ADD=PROCEDURE, -
                MY_SUB/UPDATED_SUB=PROCEDURE, -
                MY_DATA=DATA, -
                MY_DATA_PSECT=PSECT)

Ctrl/Z
```

This example creates a symbol vector to be upward compatible with the shareable image from the last example. Images linked against the old shareable image continue to work. For calling `MY_ADD` and `MY_SUB`, they use the first and second entry. The old `MY_ADD` is still available, but no longer public. The old `MY_SUB` is replaced by `DEPRECATED_SUB`. Newly linked images will always use the third and fourth entry for `MY_ADD` and `MY_SUB`, the updated public interfaces. For `MY_DATA` and `MY_DATA_PSECT`, all images use entries 5 and 6 to reference the unchanged data interfaces.

```
$ LINK/SHAREABLE MY_SHARE, SYS$INPUT/OPTIONS
GSMATCH=LEQUAL, 1, 200
CASE_SENSITIVE=YES
SYMBOL_VECTOR=(          my_mul=PROCEDURE, -
                MY_MUL/my_mul=PROCEDURE, -
                    my_div=PROCEDURE, -
                MY_DIV/my_div=PROCEDURE, -
                    my_data=DATA, -
                MY_DATA/my_data=DATA)
CASE_SENSITIVE=NO
Ctrl/Z
```

This example creates a symbol vector or a shareable image with all the symbols in the GST as lowercase and uppercase names. This is useful if applications built in the traditional way (compilers uppercase global names) and built as in the Open Source environment (global names as-is) link against that shareable image.

UNIVERSAL= (VAX Only)

`UNIVERSAL= (VAX Only)` — For VAX linking, declares a symbol in a shareable image as universal, causing the linker to include it in the global symbol table of a shareable image.

Format

```
UNIVERSAL=symbol-name [ , . . . ]
```

Description

This option may be specified only in the creation of a shareable image.

For more information about declaring universal symbols, refer to Chapter 8.

Option Values

symbol-name

The name of the symbol or symbols you want to declare universal.

Example

```
$ LINK/SHAREABLE MY_SHARE, SYS$INPUT/OPTIONS  
UNIVERSAL=MY_SYMBOL  
Ctrl/Z
```

In this example, the linker includes the universal symbol MY_SYMBOL in the global symbol table of the shareable image MY_SHARE.EXE.

Glossary

This glossary defines key terms for the OpenVMS Linker. The OpenVMS Linker is part of the OpenVMS operating system which is available on x86-64, Integrity, Alpha, and VAX hardware platforms. Certain terminology commonly used by the linker on OpenVMS Alpha and OpenVMS VAX systems might be different on OpenVMS x86-64 and OpenVMS I64 systems.

based cluster	An Alpha and VAX term. A cluster located at a base address using the CLUSTER= option.
brief map	Information produced by the linker when the /BRIEF qualifier is specified with the /MAP qualifier. A brief map contains only a subset of the default map. See Also image map .
default map	Information produced by the linker when the /MAP qualifier is specified without the /BRIEF and /FULL qualifiers. See Also image map .
demangler	A compiler tool that translates mangled names back to their source-name equivalents. Recent compilers are able to include demangling information when they generate their object modules. See Also mangled names .
ELF	See Executable and Linkable Format (ELF) .
Executable and Linkable Format (ELF)	<p>The object and image format as described in <i>System V Application Binary Interface</i>. The ELF format is extensible; that is, it can contain hardware and software extensions.</p> <p>For I64 systems, a hardware extension is used as described in the <i>Intel Itanium Processor-specific Application Binary Interface</i>.</p> <p>For x86-64 systems, a hardware extension is used as described in the <i>System V Application Binary Interface, AMD64 Architecture Processor Supplement</i>.</p> <p>In the OpenVMS x86-64 and I64 extensions, ELF is the object and image file format for object and image binaries. Compilers, assemblers, and other language processors whose output is used by the OpenVMS Linker utility must produce object files that conform to the OpenVMS extensions of the ELF specification.</p>
executable image	The primary type of image created from a link operation. This image can be executed from the DCL command line. See Also shareable image .
fix-up	Executable and shareable images can have references to shareable images. At link time, when symbols are resolved, the address values are not known. They become visible when the image activator maps the shareable image. At that time, the image activator "fixes up" the references with the address values.

full map	Information produced by the linker when the /FULL qualifier is specified with the /MAP qualifier. To tailor the full information, you can use keywords to add or suppress specific information. See Also image map .
function descriptor	An I64 term. As defined in the <i>VSI OpenVMS Calling Standard</i> , a function descriptor is the pairing of a code address and a global pointer. With this information, a call to the function (or procedure) can be made, and the called function can access its data by way of the global pointer.
hard definition	A symbol with compiler-supplied storage that is not in an overlaid section.
header table	An ELF term. The ELF format describes portions of the object and image modules, as well as their attributes, using section and segment headers. These headers are contained in two arrays of headers called the Section Header Table (for section headers) and the Program Header Table (for program segment headers). Only one header, the main ELF header, is not listed in either of these tables. It is located at the beginning of the module. See Also Executable and Linkable Format (ELF) .
image file	A file containing binary code and data of a program for an OpenVMS system; essentially, an image of what is in memory when the program is started. Also called an image.
image header	An Alpha and VAX term. The part of an executable or shareable image that describes the contents of the image file (the image sections). It is located at the beginning of the file.
image initialization	The part of the link operation where the linker, after it resolves references and obtains memory requirements, initializes the image by filling it with the compiled binary code and data.
image map	Information generated by the linker that describes the contents of the image and the linking process. The image map helps you determine programming and link-time errors, study the layout of the image in virtual memory, and keep track of global symbols. You control the information generated by the map by accepting the default map, or by specifying either a brief or full map. See Also default map, brief map, full map .
image optimization	An I64 and Alpha term. Actions the linker takes to improve run-time performance of an image it creates. For example, for OpenVMS I64 images, the linker can optimize data references to the short data segment.
image relocations	Address suggested by the linker that image activator uses to relocate the image. See Also relocations .
linkage pair	An Alpha term. A compiler-generated small data structure to implement a call. A linkage pair consists of the required information to make a call: the code address and the procedure descriptor address

of a procedure. The linkage pair is not defined in the *VSI OpenVMS Calling Standard*. It is an implementation detail used by compilers and understood by the linker.

- local function descriptor** An I64 term. As defined in the *VSI OpenVMS Calling Standard*, a function descriptor is the pairing of a code address and a global pointer. With this information, a call to the function (or procedure) can be made and the called function can access its data by way of the global pointer. The calling standard requires a local function descriptor for each call to another image. Local function descriptors are set up by the linker. Although for each call a different local function descriptor can be used, the linker sets up and re-uses one local function descriptor per target function. The linker creates a fix-up for each local function descriptor.
See Also **fix-up**, **official function descriptor**.
- mangled names** The process where some compilers create abbreviated symbol names to implement language features or to use shortened, unique names. For example, C++ compilers mangle symbol names to guarantee unique names for overloaded functions.
See Also **demangler**.
- object file** A file produced from a source language by a language processor (compiler, assembler, etc.) that contains one or more object modules that serves as input to the linker.
See Also **image file**.
- official function descriptor** An I64 term. As defined in the *VSI OpenVMS Calling Standard*, a function descriptor is the pairing of a code address and a global pointer. With this information, a call to the function (or procedure) can be made and the called function can access its data via the global pointer. The linker sets up an official function descriptor to implement calls to the function (or procedure). As such, an official function descriptor is an entry point. An entry is unique: there can be only one official function descriptor per function (or procedure).
See Also **local function descriptor**.
- OpenVMS system** A system running the VSI OpenVMS operating system. These include OpenVMS x86-64, I64, Alpha, and VAX operating systems.
See Also **system**.
- OpenVMS Alpha system** An HPE Alpha system running the OpenVMS Alpha operating system. Also referred to as Alpha system or Alpha.
- OpenVMS I64 system** An HPE Integrity server running the OpenVMS I64 operating system. Also referred to as I64 system or I64.
- OpenVMS VAX system** An HPE VAX system running the OpenVMS VAX operating system. Also referred to as VAX system or VAX.
- OpenVMS x86-64 system** A server running the OpenVMS x86-64 operating environment. Also referred to as x86-64 system or x86-64.
- OpenVMS 64-bit system** An OpenVMS Alpha, OpenVMS I64, or OpenVMS x86-64.

platform	A generic term referring to all systems of a specific processor architecture. For example, Intel Itanium. See Also system .
privileged shareable image	A shareable image containing privileged code. For example, user-written system services allow user-mode programs to call routines that can perform functions that require privileges. These services are implemented in shareable images. Because of the presence of privileged code, they are referred to as privileged shareable images. See Also protected shareable image .
program section	An area of memory that has a name, a length, and other attributes describing the intended or permitted usage of that portion of memory. Program sections are part of an object module. At link time, the user can set or change some of the attributes so the linker combines them in a manner that the user controls.
program segment	An x86-64 and I64 term. A chunk of the image binary, usually data or code. In general, everything that needs to be available to activate and run the image. See Also image header .
protected shareable image	A shareable image created with the /PROTECT qualifier. Privileged shareable images must be protected from user-mode and supervisor-mode write access. See Also privileged shareable image .
psect	See program section .
relaxed definition	See tentative definition .
relocations	The linker combines object binaries (code and data) from different object modules. The language processors do not know where their modules will be located in virtual address space. Therefore, the language processors generate information packets for the linker, called relocations, so that code execution and data references will work from any linker-chosen memory location. The linker applies these relocations to data. Because the image activator can place an image at any memory location, the linker produces relocations, called "image relocations", to assist the image activator. Code is always position independent, that is, it requires no relocations.
shareable image	A collection of data and program services that is a product of a link operation and is not directly executed from the DCL command line. To make use of a shareable image, it must first be included as input in a link operation that produces an executable image. See Also executable image .
symbol resolution	The process of resolving references to symbols whose definitions are external to the module.
system	The computer hardware; the server. Distinguish from the operating system (for example, OpenVMS Alpha). See Also platform .

system image

An Alpha and VAX term. A product of a link operation producing an image that can be run as a standalone program, without operating system support. Therefore, these images typically do not contain image activation information. On OpenVMS x86-64 and I64 systems, images always contain image activation information. As a result, the x86-64 and I64 linkers do not create system images.

See Also **executable image**.

tentative definition

A symbol definition without compiler supplied storage or storage in overlaid sections. There can be tentative definitions for a symbol in several modules. If no hard definition for the symbol is encountered, one of the tentative definitions for that symbol is selected by the linker to be the defining instance.

See Also **hard definition**.

