



OPEN CONNECTIVITY
FOUNDATION®

OCF 2.1.0 Specification Introduction and Overview

December 2019



Disclaimer Notice

This Specification Overview document is for informational purposes only. It has not been adopted in full or in part by the Open Connectivity Foundation, and should not be relied upon for any purpose other than for review of the information contained herein. This document is subject to change, and the Open Connectivity Foundation and its members reserve the right without notice to you to change any or all portions hereof, delete portions hereof, make additions hereto, discard this document in its entirety or otherwise modify this document at any time. You should not and may not rely upon the contents of this document in any way, including but not limited to for the development of any products or services. In order to be considered a certified product, among other requirements, a product or service must be compliant with Final Specification of the Open Connectivity Foundation. To the extent this document references all or portions of a Draft or Final Specification of the Open Connectivity Foundation, or information related thereto, such references are made solely for informational purposes. This document is not a Draft or Final Specification of the Open Connectivity Foundation. Neither this document nor any of its contents is subject to or related to any licensing grants or commitments contained in the Open Connectivity Foundation Intellectual Property Rights (IPR) Policy or elsewhere. This document may contain or make reference to logos, brands, names, or other works of Open Connectivity Foundation, its members, or other third parties. The OCF logo is a trademark of Open Connectivity Foundation, Inc. in the United States or other countries. Other brands, names, or works contained herein may be claimed as the property of others. Any copying or other form of reproduction and/or distribution of this document or these works is strictly prohibited.



Table of Contents

- Fundamentals of OCF
- Technical Principles for an Internet of Things Ecosystem
- Introduction to the Open Connectivity Foundation
- OCF Specification Overview
 - Core Framework
 - Core Extension: OCF Cloud
 - Core Extension: Wi-Fi Easy Setup
 - Security
 - Bridging
 - OCF to AllJoyn Mapping
 - OCF to OneM2M Mapping
 - OCF to Zigbee Mapping
 - Resource Type
 - Device Profile



OPEN CONNECTIVITY
FOUNDATION®

Core Fundamentals of OCF



Core Framework Fundamentals

Building Blocks



- Enable the development of vertical profiles (e.g. Smart Home, Smart Commercial) while maintaining fundamental interoperability via an Architecture that is scalable from resource constrained devices to resource rich devices

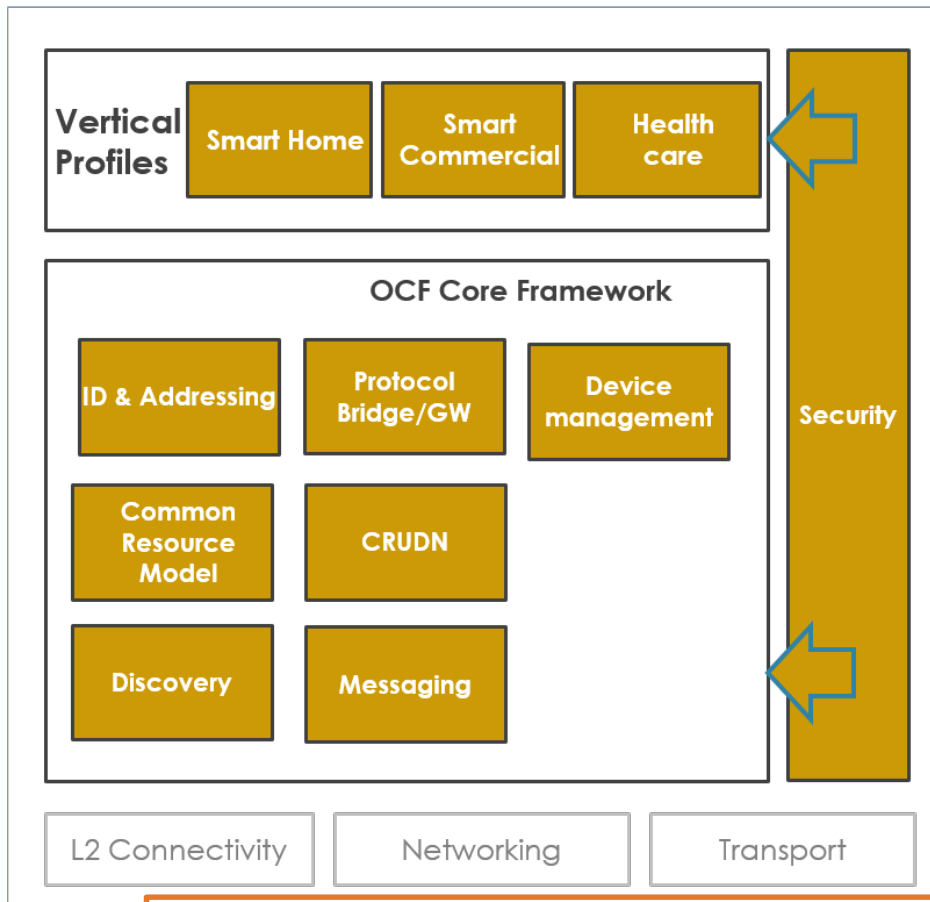

- ① **Discovery:** Common method for device discovery (Multicast CoAP to All OCF Nodes Address)
- ② **Messaging:** Constrained device support as default (IETF CoAP) as well as protocol translation via bridges
- ③ **Common Resource Model:** Real world entities defined as data models (resources)
- ④ **CRUDN:** Simple Request/Response mechanism with Create, Retrieve, Update, Delete, and Notify operations
- ⑤ **ID & Addressing:** Device Identifiers and OCF URIs (map to transport protocol)
- ⑥ **Protocol Bridge:** Framework provided by the Bridging Specification

Security is fundamental to the OCF ecosystem and applies to all elements

Core Framework Fundamentals Realized in the Protocol Stack

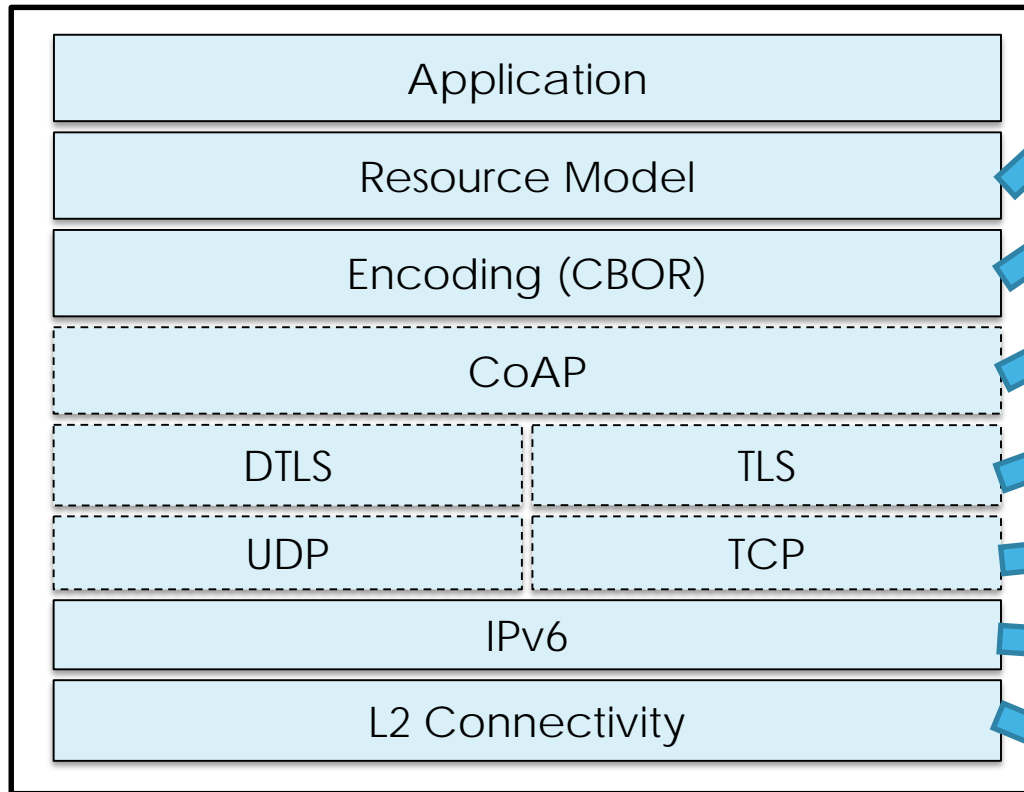

OCF Stack

Common Resource Model defined using Open API 2.0

Concise representation on the wire
(binary encoded JSON)

Constrained device support via use of CoAP as the transport layer

Secure connection

Connectionless or Connection Oriented

IPv6 as the harmonization layer

Agnostic of underlying physical layer technology
(Wi-Fi, Ethernet, Thread)



OPEN CONNECTIVITY
FOUNDATION®

Security Fundamentals of OCF





Secure device lifecycle

Secure operation

...is our end goal

Our objectives:

- ✓ Confidentiality
- ✓ Integrity
- ✓ Availability

The risks we face:

- Message interception/forgery
- Spoofing/privilege escalation
- Denial of service
- Device hijack



How do we get there?

(D)TLS sessions used for non-discovery connections

Authentication done as part of handshake

Randomized identity bound to credential:

- for PSK, identity is bound via 1-to-1 mapping
- for certificate, identity is in the Subject Name

Fine grained access control done for CRUDN operations on per-resource basis. Permission is denied by default

Wildcards and roles supported for scalability

* (D)TLS = (Datagram) Transport Layer Security
* PSK = Pairwise Secret Key
* CRUDN = Create, Retrieve, Update, Delete, Notify



Secure device lifecycle

Secure provisioning

...is configuration of Security Virtual Resources by an authorized client, usually by the onboarding tool

Onboarding tool has full ownership and control over device during the ownership transfer procedure, which ends with installation of an Owner Credential

SVRs contain sensitive data and require atomic updates, so all OCF devices maintain internal state machine

AMS/CMS have implicit control over their dedicated resources, and are responsible for post-onboarding provisioning

- Onboarding tool (OBT) includes
- DOTS for Device Ownership Transfer
 - CMS for Credential Management
 - AMS for Access Rights Management
 - Mediator (optional) for Easy Setup or Device-to-Cloud provisioning

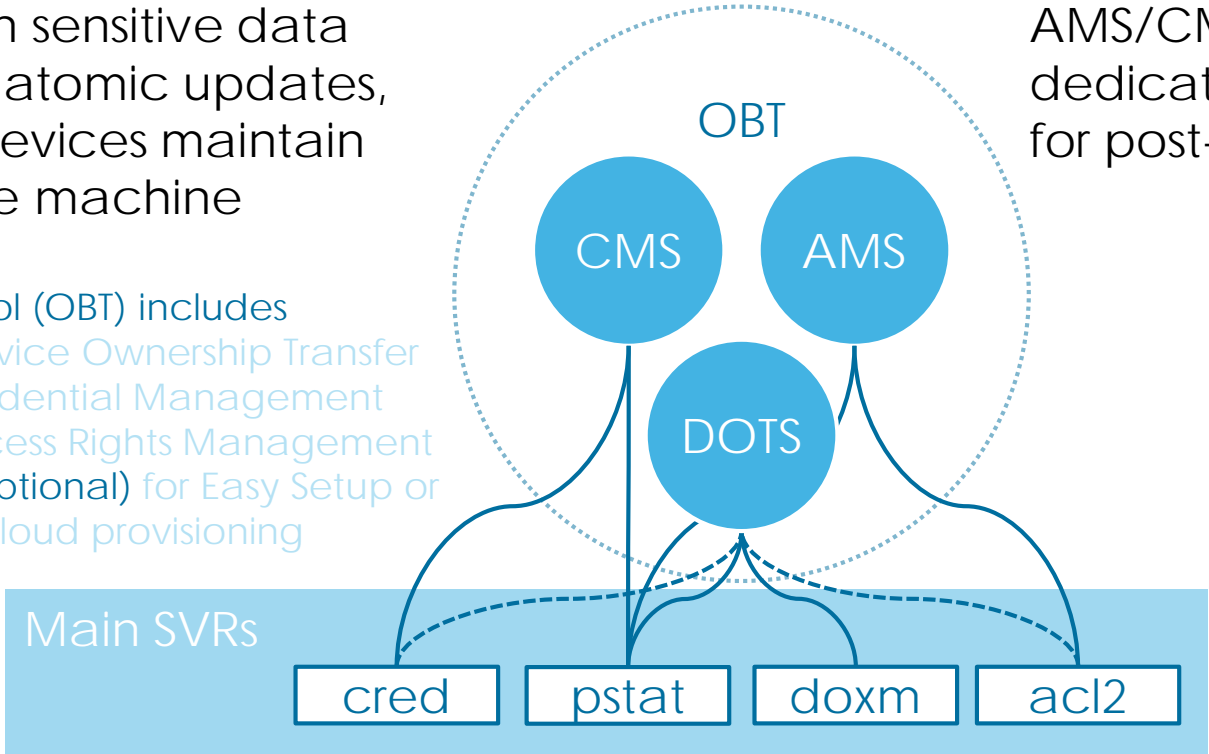

Device Provisioning Status (pstat) is updated by the OBT services to trigger the state machine transitions:

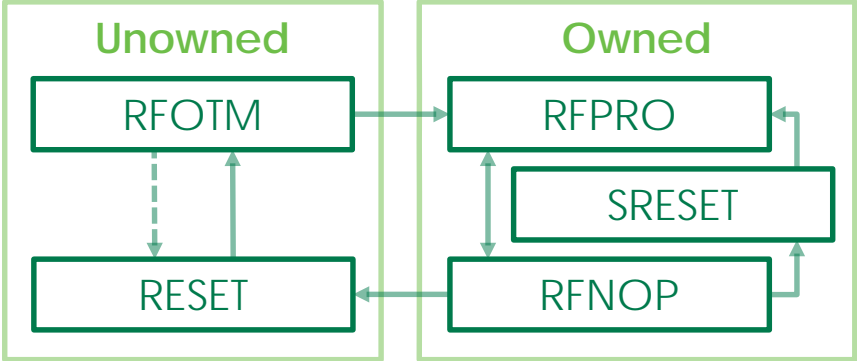



OPEN CONNECTIVITY
FOUNDATION®

Technical Principles for an Internet of Things Ecosystem





OPEN CONNECTIVITY
FOUNDATION®

Introduction to the Open Connectivity Foundation





Scope of IoT

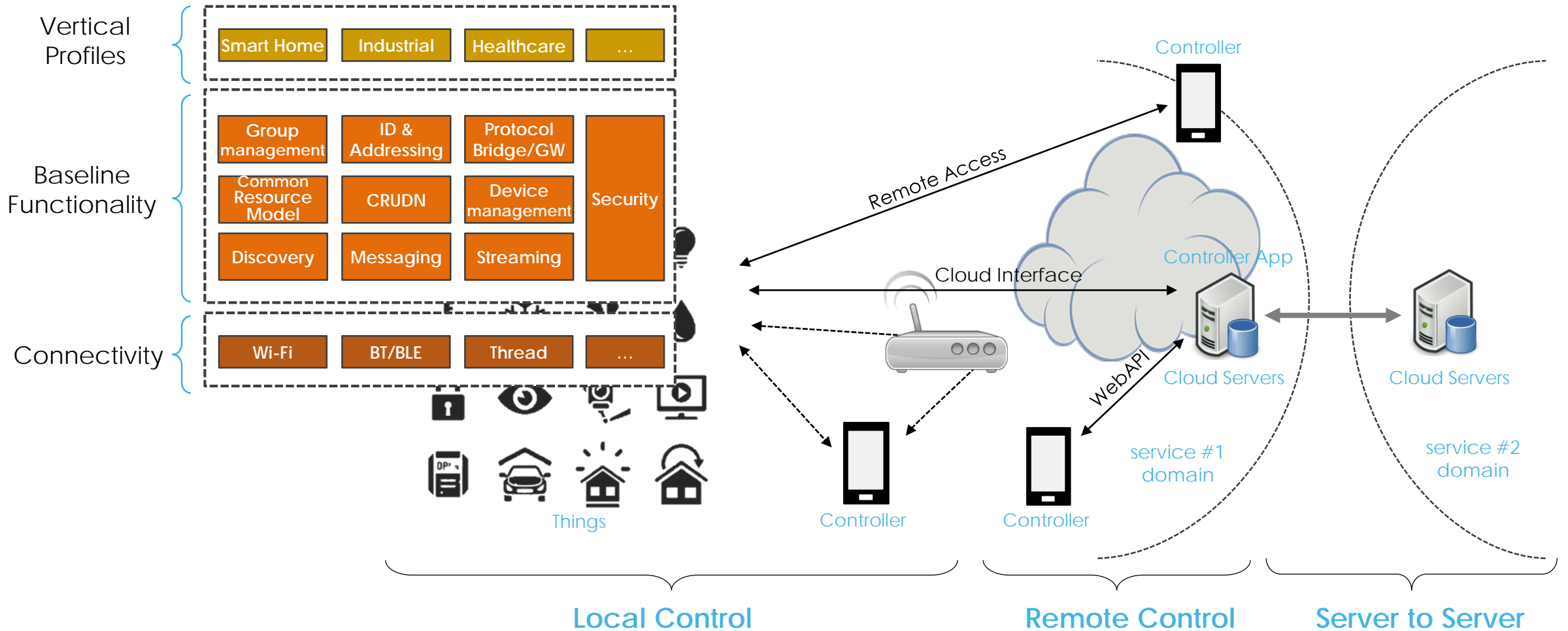



Approaches to definition of various Things

- By defining resources of things and its properties

- By defining functions/operations of things

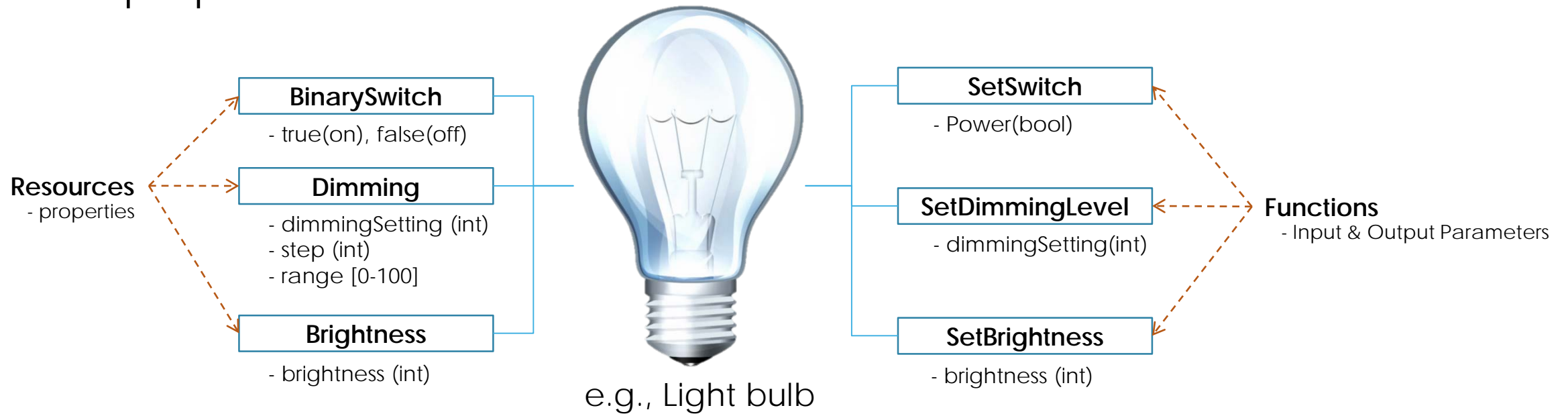

- (no Verbs) + Objects

*Fixed set of verbs (CRUDN) from transport layer will be used

- Resource model in RESTful Architecture
(e.g., W3C, CSEP, etc.)

- (Verbs + Objects)

- RPC model

Support of Constrained Things

Class 2 Devices as Defined by RFC 7228



- Less overhead/ Less Traffic
 - Minimize CPU Load, Memory impacts, Traffic and Bandwidth
 - Compact header
 - Binary protocol
 - Compressed encoding of payload
- Low Complexity
 - Simple Resource Model
 - > Short URI (Late Binding w/ resource type defined)
 - > Broad and Shallow Hierarchy



Support of Multiple Verticals

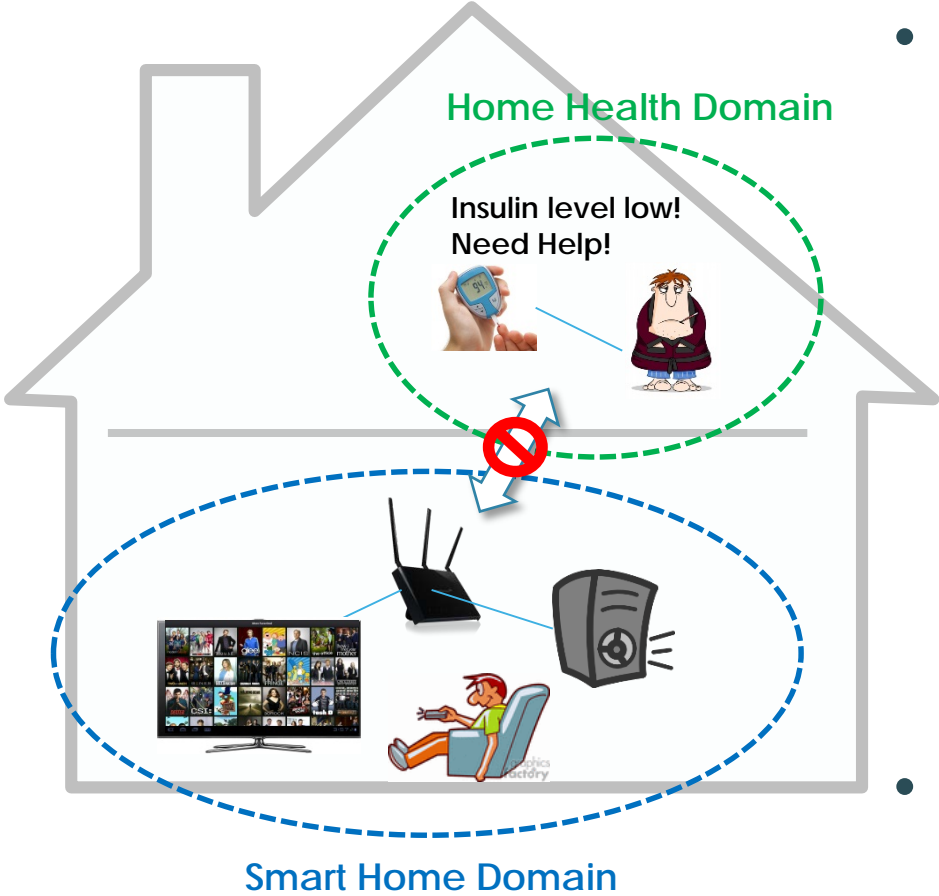

- Legacy vertical services usually designed as silos
→ No common way to communicate among them

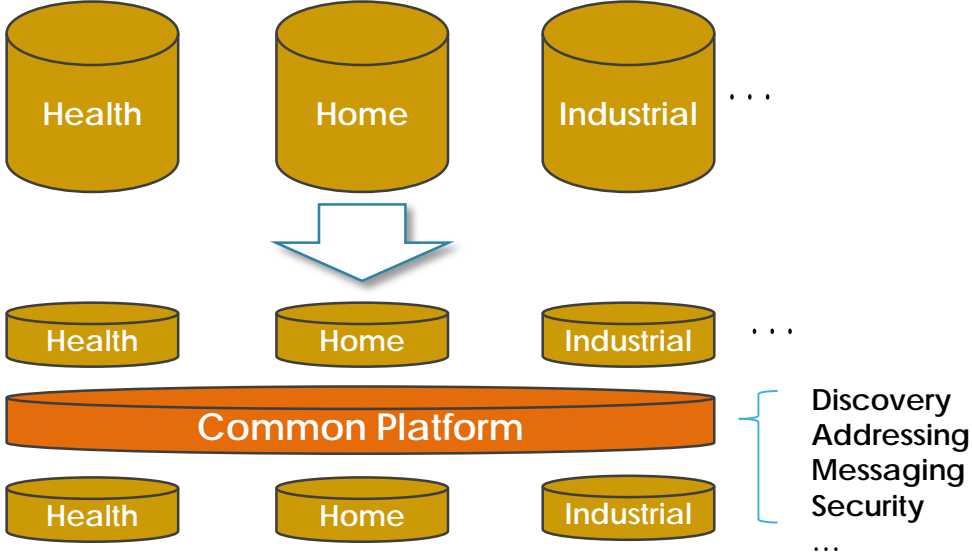

- A common platform provides a foundation for vertical services to collaborate and interwork by providing common services and data models



Conformance & Certification

- Conformance test - Each device proves conformance to specifications

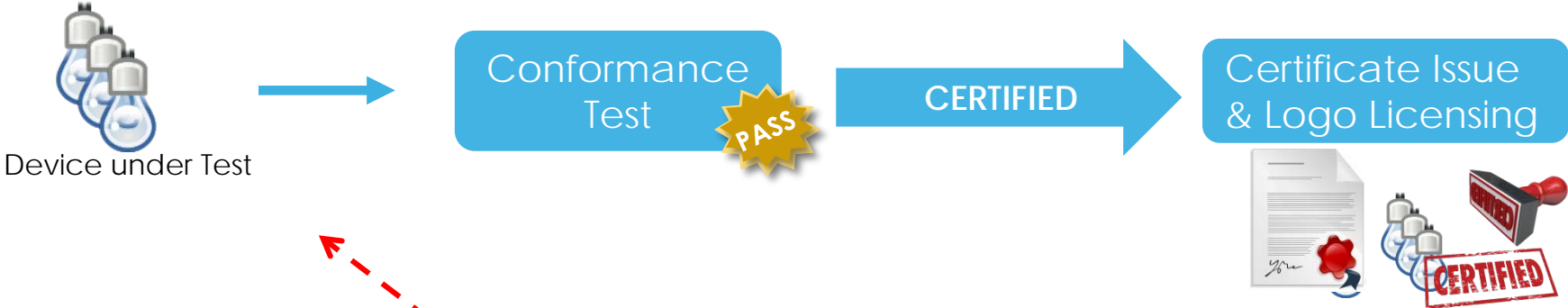

- Certification Scope

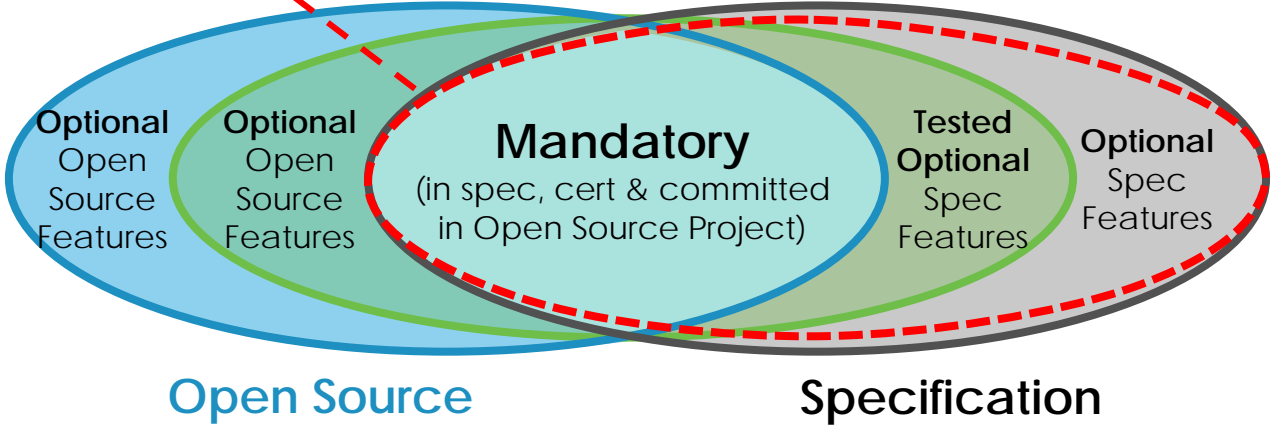



Licensing

- For Intellectual Property Rights(IPR) Policy : RAND-Z > RAND >> no IPR policy
- For Open Source : Apache 2.0 > Internet Systems Consortium (ISC)
- Due to the common nature of IoT connecting everything over the Internet, it's most critical for manufacturers to avoid a licensing risk
 - Everything connected could be at potential risk
- Offering manufacturer-friendly Licensing and IPR Policy enables growth of market by attracting both start-ups and large enterprises; such an IPR policy must be clear and readily understandable ensuring that the terms are offered by all member company IP holders.



OPEN CONNECTIVITY
FOUNDATION®

Introduction to the Open Connectivity Foundation





Introduction to OCF – Optimized for IoT

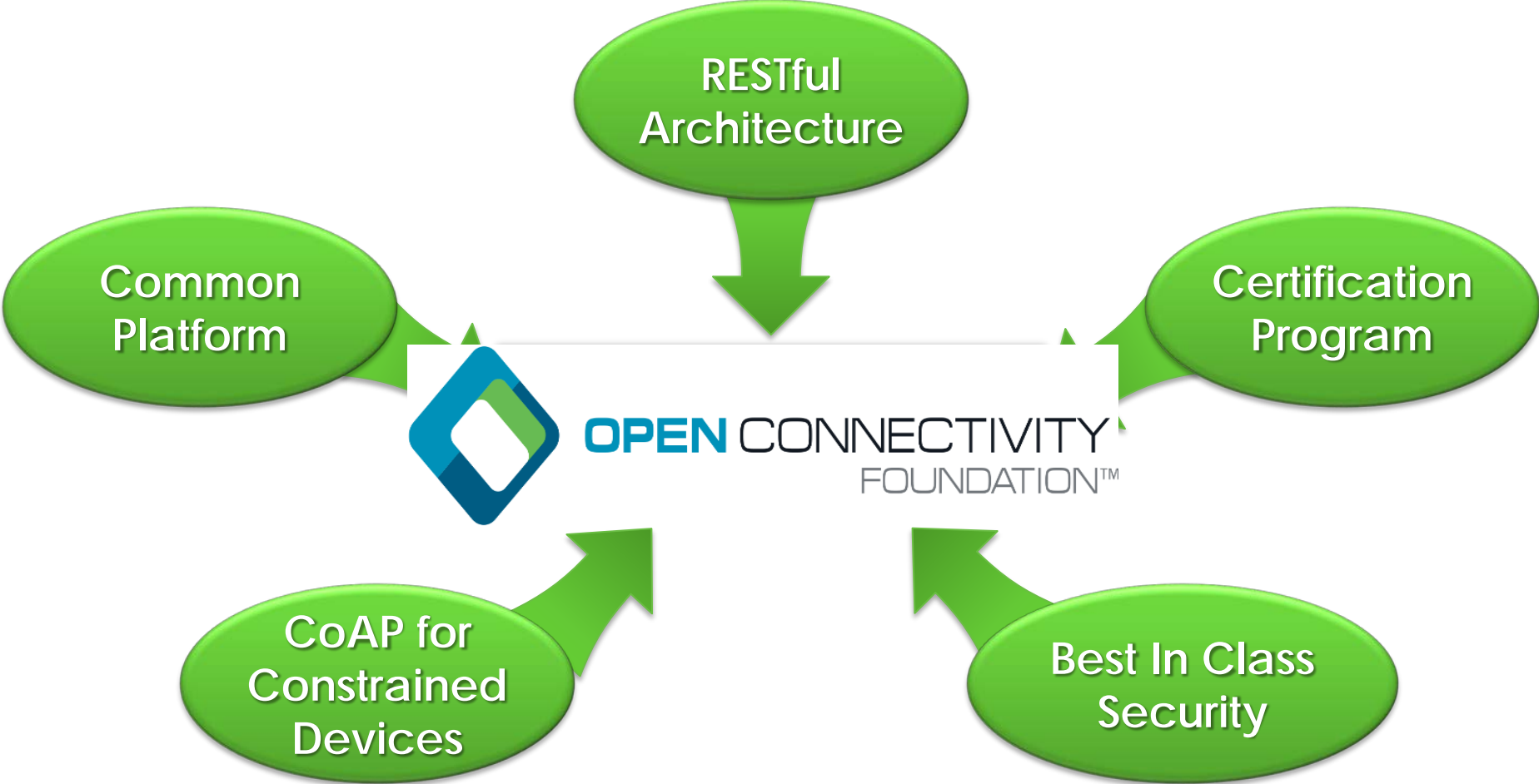



OCF Areas of Technology Development

- Core Architecture
 - Fundamental resource framework
 - Discovery
 - CRUDN
 - Transport Binds
- Security
- Resource Models (vertical agnostic)
- Device Profiles
 - Smart Home
 - Health
 - Automotive
- Ecosystem Bridging



OCF Key Concepts (1/2)

- **Dedicated and optimized protocols for IoT (e.g. CoAP)**
 - Specific considerations for constrained devices
 - Fully compliant towards RESTful architecture
 - Built-in discovery and subscription mechanisms
- **Standards and Open Source to allow flexibility creating solutions**
 - Able to address all types of devices, form-factors, companies and markets with the widest possibility of options
 - Open Source is just one implementation to solve a problem



OCF Key Concepts (2/2)

- **Certification testing for interoperability**
 - Formal conformance testing for device validation to specifications
 - Plugfest testing for product interoperability
- **Certification and Logo program**
 - Products with the OCF Logo ensure OCF specifications are met
 - Logo reflects being part of an ecosystem of interoperable products



OPEN CONNECTIVITY
FOUNDATION®

OCF Specification Overview





OCF Deliverables

Normative Specifications

- See next slide

Resource Models via oneIoTa

- Domain agnostic resources
- Derived models for Ecosystem Mapping
 - To date: OCF-AllJoyn (CDM 16.4), OCF-oneM2M, OCF-Zigbee , OCF-UPlus, OCF-BLE, OCF-ZWave

Certification Procedures

- Test Policy (Certification Procedure Requirements Document)
- Test Plans and Test Cases (Certification Test Requirements Document)



Specification Structure

Infrastructure

- Core Mandatory Framework, Core Optional Extensions
- Security
- Bridging Framework
- Device Specification

Resource Model

- Resource Specification (reflects Onel0Ta content)
- Ecosystem Mapping Specifications (reflect Onel0Ta content):
 - OCF to AllJoyn
 - OCF to BLE
 - OCF to oneM2M
 - OCF to UPlus
 - OCF to Zigbee
 - OCF to ZWave



Specification Location

Where can I find the specifications and Resource Type definitions?

OCF Specifications:

- <https://openconnectivity.org/developer/specifications>

Resource Type Definitions

- Core Resources: <https://github.com/openconnectivityfoundation/core>
- Core Extension Resources: <https://github.com/openconnectivityfoundation/core-extensions>
- Bridging Resources: <https://github.com/openconnectivityfoundation/bridging>
- Cloud Resources: <https://github.com/openconnectivityfoundation/cloud-services>
- Security Resources: <https://github.com/openconnectivityfoundation/security-models>
- Vertical Resources and Derived Models:
https://oneiota.org/documents?filter%5Bmedia_type%5D=application%2Framl%2Byaml

OneIoTa Tool



The screenshot displays the OneIoTa web interface. At the top, there is a search bar labeled "Search All Models" and a "Sign In" button. Below this, a navigation bar shows "All Models (181)" and "Releases (2)". The main content area is a table of models with columns for Filename, Type, Date, Organization, Release, Proposals, and Versions. The table lists several RAML models, including acceleration.raml, activityCount.raml, and airFlowControl.raml. Below the table, a detailed view of a JSON Schema is shown for "oic.r.autofocus.json". This view includes a "Versions" section with a list of versions (06 Jun 2017, Mark Trayer (Submitter), and Hide Notes), a "Submission Notes" section, and a "References" section. The JSON Schema itself is displayed in a code editor, showing the structure of the "Auto Focus" model.

- Web based (see: <http://oneiota.org>) development tool
- Supports RAML, JSON, and OpenAPI2.0 syntax
- Populated to date with all OCF Resources defined using OpenAPI2.0; also all derived models for the defined ecosystem bridges.
- Supports multiple organizations
 - Each submitting organization defines their own license terms



OPEN CONNECTIVITY
FOUNDATION®

Infrastructure: Core Framework Specification

OCF 2.1.0 Release Overview





Core Framework Topics Outline (1 of 2)

- Objectives
- RESTful Architecture
- OCF Roles
- Resources
- Basic Operations
- Organization of an OCF Device
- OCF Specification Features
- Protocol Stack
- Endpoint Overview



Core Framework Topics Outline (2 of 2)

- Resource Discovery (CoAP Discovery)
- Block Transfer with CoAP Messaging
- Encoding Schemes
- Introspection
- Collection Resources
- Atomic Measurement Resources
- Device Reset
- Versioning



Core Optional Framework Topics Outline

- Objectives
- Device/Platform Configuration
- Device Management
- Alerts
- Icons



OPEN CONNECTIVITY
FOUNDATION®

Mandatory Core Technology Core Framework Specification





Core Framework Objectives

- Core Framework Specifications Scope
 - Specifies the technical specification(s) comprising of the core architectural framework, messaging, interfaces and protocols based on approved use-case scenarios
 - Enables the development of vertical profiles (e.g. Smart Home, Health) on top of the core while maintaining fundamental interoperability
- Architect a core framework that is scalable from resource constrained devices to resource rich devices
- Reuse open standards solutions (e.g. IETF) where they exist
- Ensure alignment with IoTivity Lite open source releases

RESTful Architecture

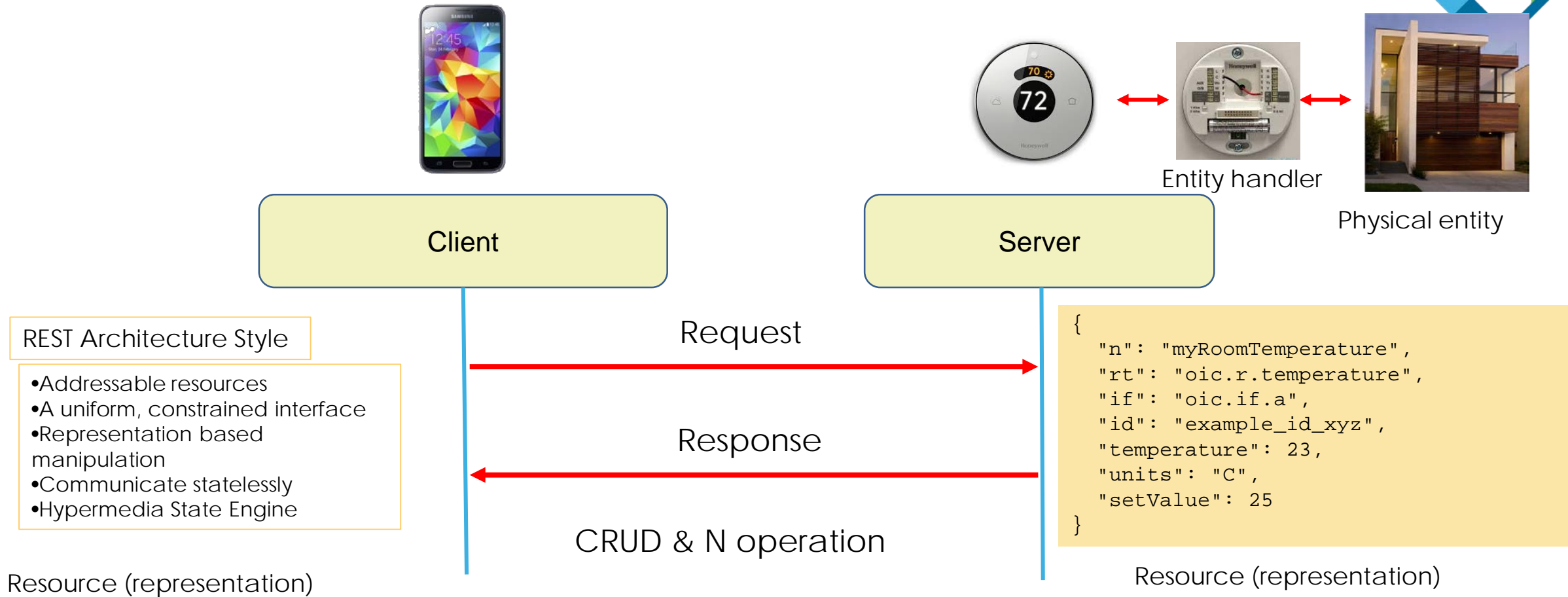

RESTful Architecture (Representational State Transfer)

- Resource based operation
 - Real world 'entity' is represented as 'Resource'
- Resource manipulation via Request/ Response: CRUDN



OCF Roles

- Current OCF Architecture defines 2 logical roles that devices can take
 - OCF Server : A logical entity that exposes hosted resources, is discoverable, and responds to client initiated transactions
 - OCF Client : A logical entity that interacts with resources on an OCF Server via discovery and CRUDN actions
- An OCF Device implements one or both roles





Resources

- An OCF Server contains one or more Resources to describe a real world entity
- Each Resource contains Properties that describes an aspect that is exposed through a Resource including meta-information related to that Resource
- Each Resource contains Interface(s) that provides first a view into the Resource and then defines the requests and responses permissible on that view of the Resource



OCF Core Framework Basic Operation

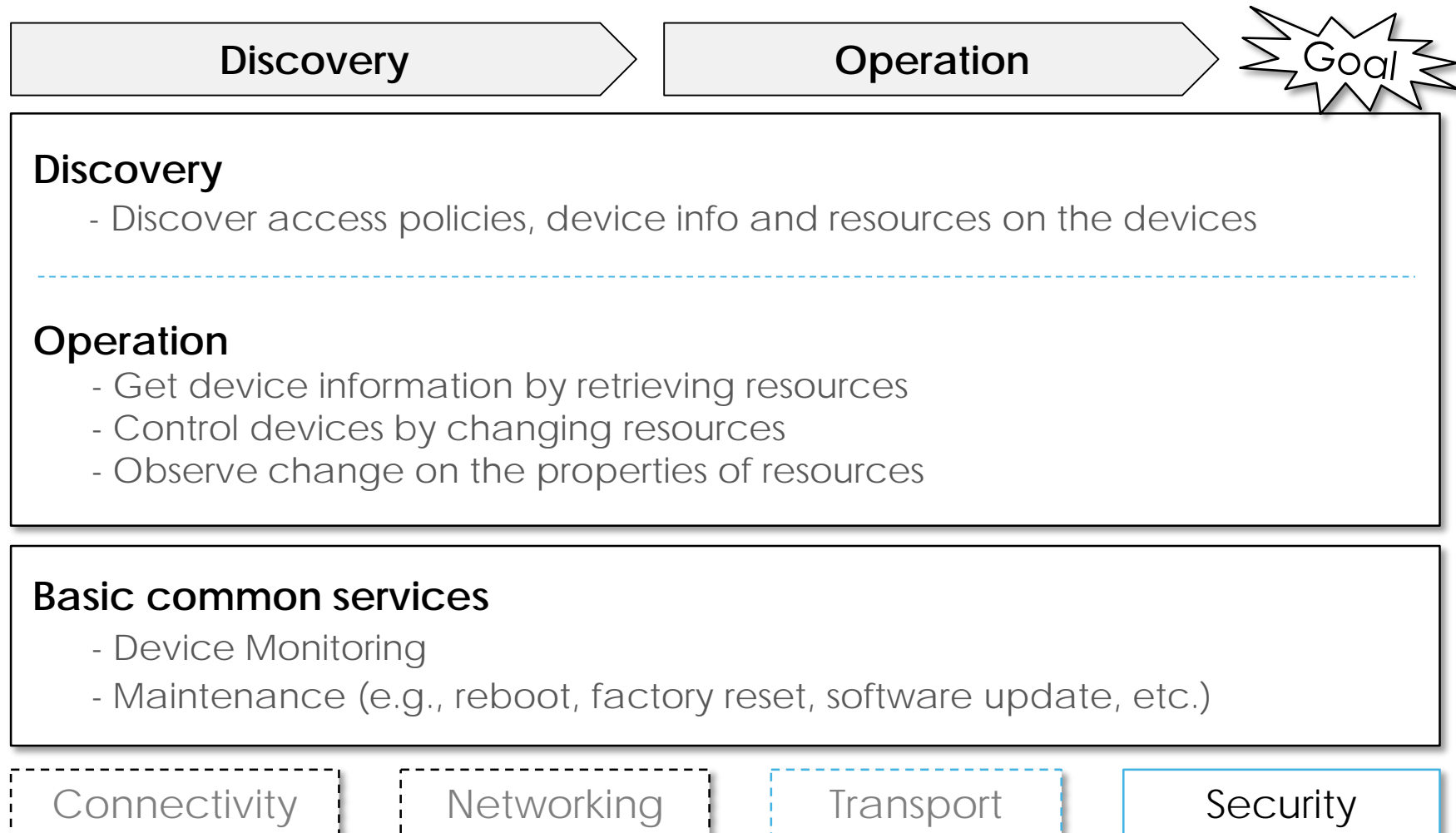



Organization of an OCF Device

- OCF Device concept

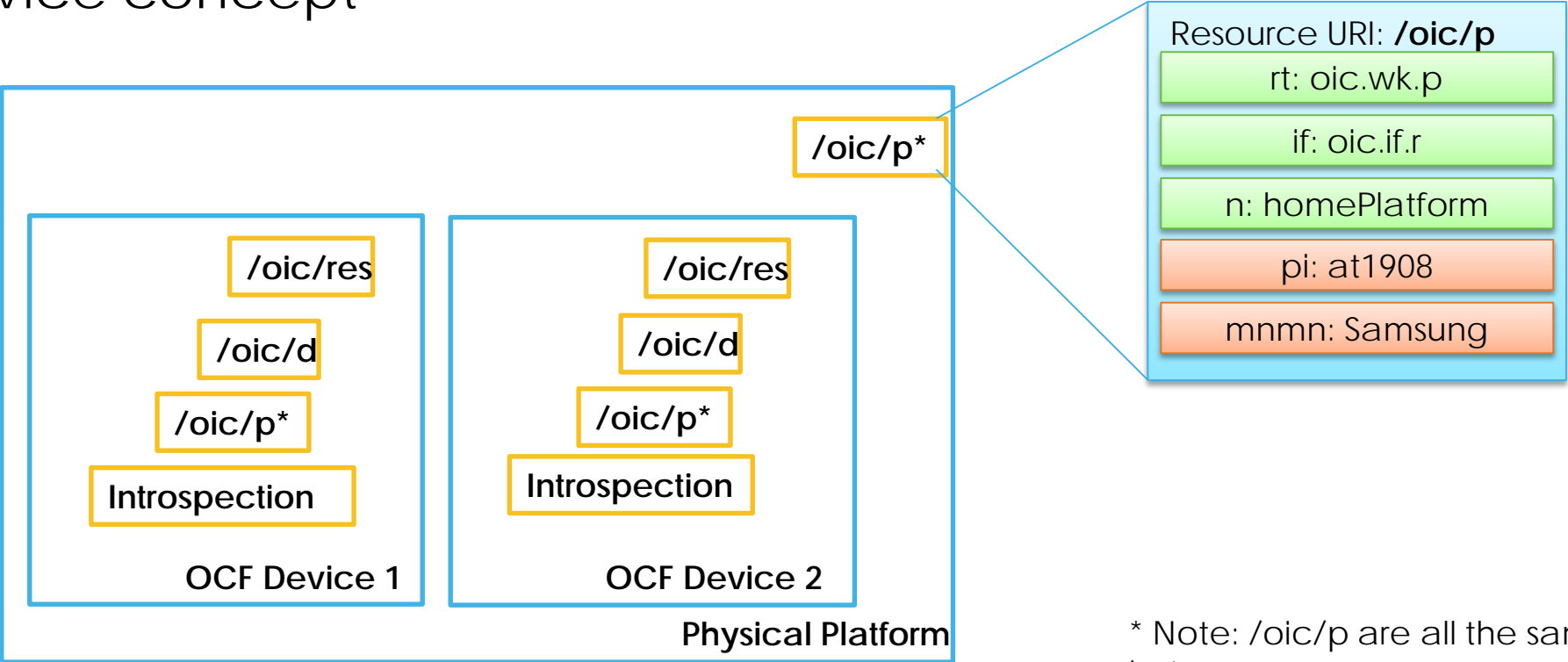

* Note: /oic/p are all the same instance



OCF Spec Features – Core Framework Spec

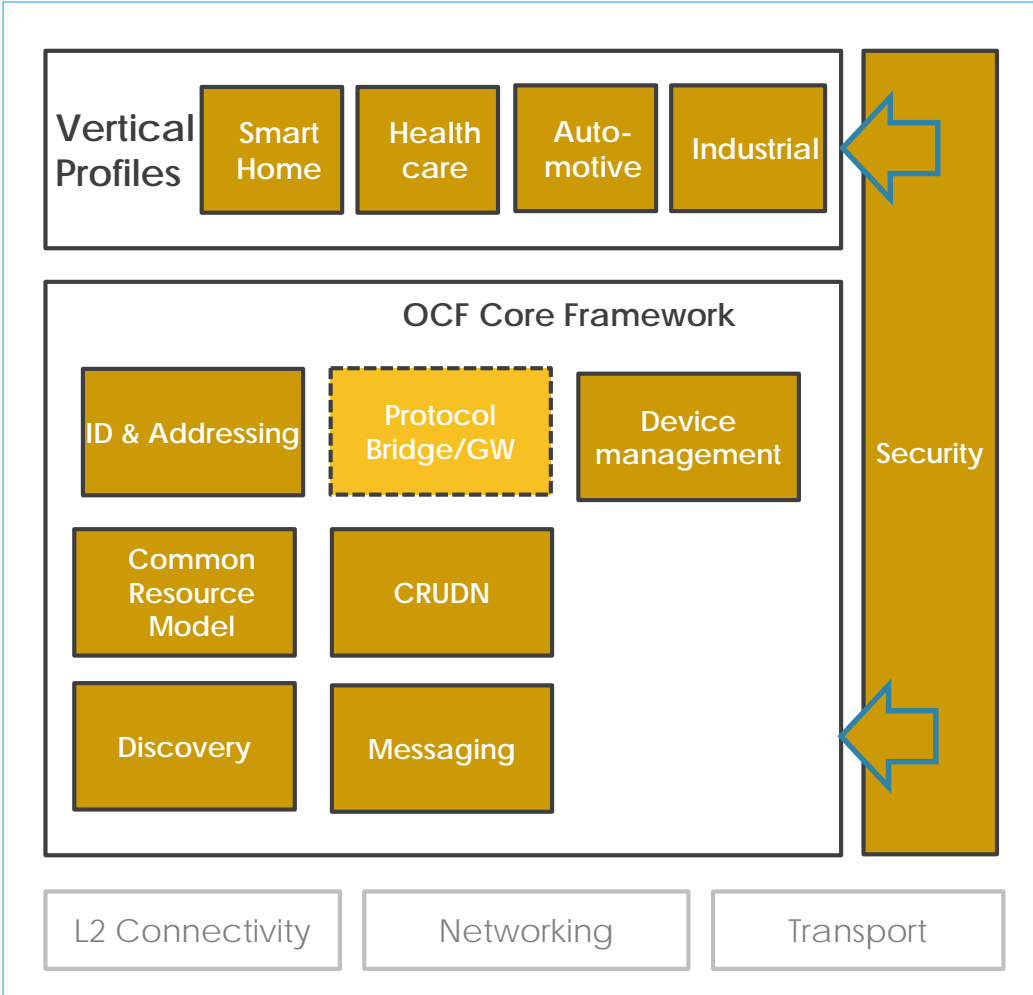

- ① **Discovery:** Common method for device discovery (IETF CoRE)
- ② **Messaging:** Constrained device support as default (IETF CoAP) as well as protocol translation via bridges
- ③ **Common Resource Model:** Real world entities defined as data models (resources)
- ④ **CRUDN:** Simple Request/Response mechanism with Create, Retrieve, Update, Delete and Notify operations
- ⑤ **ID & Addressing:** OCF IDs and addressing for OCF entities (Devices, Clients, Servers, Resources)
- ⑥ **Protocol Bridge/GW:** Handled by the Bridging Spec with some implications on the Core

Security is fundamental to the OCF ecosystem and applies to all elements



Protocol Stack

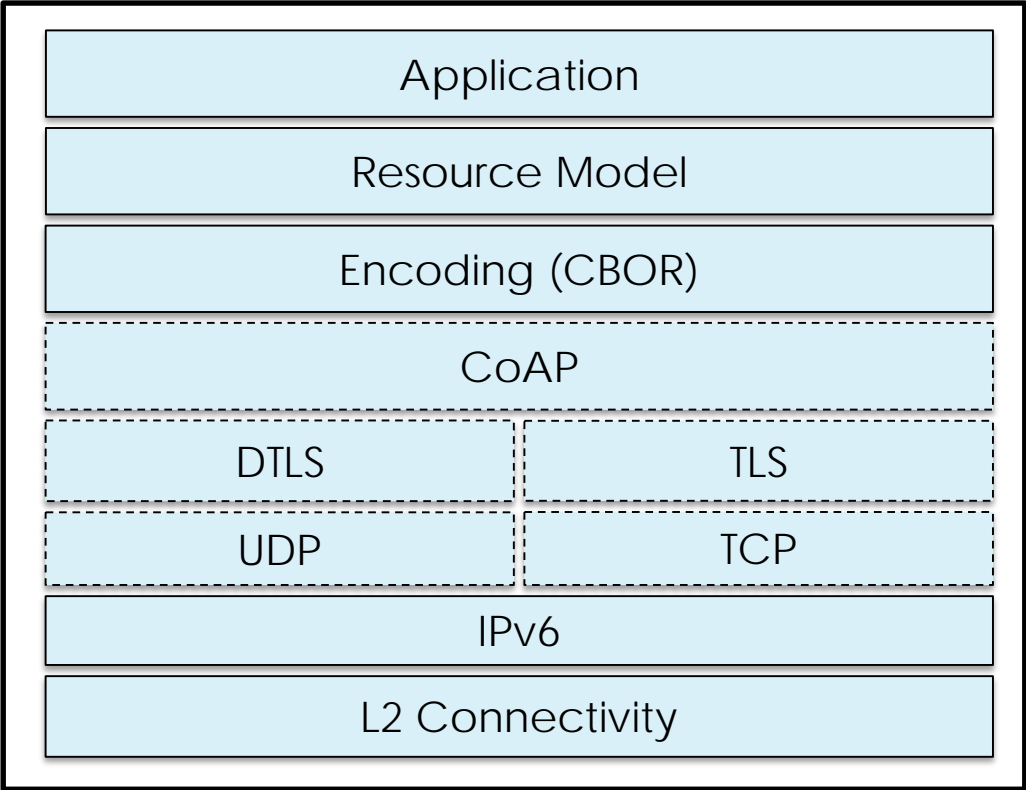

OCF Stack



Endpoint Overview

- Definition
 - An (OCF) Endpoint is defined as the source or destination of a request and response messages for a given Transport Protocol Suites (e.g. CoAP over UDP over IPv6). The specific definition of an Endpoint depends on the Transport Protocol Suites being used.
 - an address (e.g. IPv6 address + Port number) or an indirect identifier (e.g., DNS name) resolvable to an address.
 - (e.g.) For CoAP/UDP/IPv6, Endpoint is identified as IP address + port number or DNS name.
- Endpoint characteristics for OCF Device
 - Each OCF Device shall associate with at least one Endpoint with which it can exchange Request & Response messages.
 - When a message is sent to an Endpoint, it shall be delivered to the OCF Device which is associated with the Endpoint. When a Request message is delivered to an Endpoint, path component is enough to locate the target Resource.
 - OCF Device can be associated with multiple Endpoints.
 - E.g. OCF Device may support both CoAP & HTTP
 - An endpoint can be shared among multiple OCF Devices, only when there is a way to clearly indicate the target Resource with Request URI.



Endpoint information in /oic/res with "eps" Parameter



```
/oic/res
[
  { "href": "/oic/res",
    "anchor": "ocf://dc70373c-1e8d-4fb3-962e-017eaa863989/oic/res",
    "rel": "self",
    "rt": ["oic.wk.res"],
    "if": ["oic.if.ll", "oic.if.baseline"],
    "p": {"bm": 3},
    "eps": [{"ep": "coaps://[fe80::b1d6]:44444"}] },
  { "href": "/oic/p",
    "anchor": "ocf://dc70373c-1e8d-4fb3-962e-017eaa863989",
    "rt": ["oic.wk.p"],
    "if": ["oic.if.r", "oic.if.baseline"],
    "p": {"bm": 3},
    "eps": [{"ep": "coap://foo.bar.com:44444"}, {"ep": "coaps://foo.bar.com:11111"}] },
  { "href": "/oic/d",
    "anchor": "ocf://dc70373c-1e8d-4fb3-962e-017eaa863989",
    "rt": ["oic.wk.d", "oic.d.light"],
    "if": ["oic.if.r", "oic.if.baseline"],
    "p": {"bm": 3},
    "eps": [{"ep": "coap://[fe80::b1d6]:44444"}, {"ep": "coaps://[fe80::b1d6]:11111"}] },
  { "href": "/myLight",
    "anchor": "ocf://dc70373c-1e8d-4fb3-962e-017eaa863989",
    "rt": ["oic.r.switch.binary"],
    "if": ["oic.if.a", "oic.if.baseline"],
    "p": {"bm": 3},
    "eps": [{"ep": "coaps://[fe80::b1d6]:44444"}, {"ep": "coaps://foo.bar.com:11111"}] }
]
```

Endpoint for each target resource.



Resource Discovery (CoAP Discovery)

- OCF devices make use of CoAP Discovery using IANA defined OCF Service Address (not the default CoAP address).
- Multicast RETRIEVE (CoAP GET) sent to well known URI /oic/res
- Response is an array of links; each link represents a Resource hosted by the responding server
- Links provide:
 - href
 - Relationship (self link, hosted link, bridged link)
 - Endpoint binds
 - Supported interfaces
 - Observability of the Resource



Block Transfer with CoAP Messaging

- Basic CoAP messages work well for the small payloads we expect from light-weight, constrained IoT devices
- It is envisioned whereby an application will need to transfer larger payloads
- CoAP block wise transfer as defined in IETF RFC 7959 shall be used by all OCF Servers that receive a retrieve request for a content payload that would exceed the size of a CoAP datagram



Encoding Schemes – CBOR

- Everything in OCF is a Resource.
- All Resources are specified using OpenAPI 2.0 (aka Swagger) in JSON format to define the associated API
- OCF has mandated CBOR as the default encoding scheme on the wire

	CBOR	<i>JSON</i>	<i>XML/EXI</i>
Description	- Concise binary object representation based on JSON data model	<i>- Lightweight, text-based, language-independent data interchange format</i>	<i>- Binary compression standard for XML</i>
Standard	IETF RFC 7049	<i>IETF RFC 7159</i>	<i>W3C Efficient XML Interchange Format 1.0</i>
Content Type	/application/vnd.ocf+cb or	<i>/application/json</i>	<i>/application/exi</i>
OCF M/O	Mandatory	<i>Can be supported</i>	<i>Can be supported</i>

If needed in future revisions



Introspection

- What
 - Device description is available on the network
 - Device description:
 - List all end points
 - Per end point
 - Which method are implemented
 - » Query parameters per method
 - » Payloads definitions (request and response)
- How
 - Put the data described in OpenAPI 2.0 files on the wire as a CBOR encoded OpenAPI 2.0 (aka Swagger2.0) document.
 - Describes the payload on JSON level
 - Property names
 - Type
 - range



Collection Resources

- An OCF Resource that contains one or more references (specified as OCF Links) to other OCF Resources, where each Link is individually addressable, is an OCF Collection
 - Client can request a server to create and add a Resource to any collection (except /oic/res) that indicates support for creating that Resource
- An OCF Link embraces and extends typed “web links” as specified in RFC 5988
- The primary example of a collection is /oic/res (Discovery Resource).
 - A small number of Resources in the Resource Model are also collections



Atomic Measurement Resources

- An OCF Resource that ensures a Client can only access the Properties of linked Resources (specified as OCF Links) atomically, as a whole, and read-only, using the “batch” interface
 - Atomically, meaning the value of all properties of the Atomic Measurement are sampled at the same time
 - As a whole, meaning that the values of all properties of the Atomic Measurement will be returned, or no value will be returned
 - Read-only, meaning that the properties of the Atomic Measurement can only be read, not written, using the batch interface. Any attempt to write to any property of the Atomic Measurement will result in an error.
- An OCF Link embraces and extends typed “web links” as specified in RFC 5988
- The primary example of Atomic Measurement Resources are with Healthcare vertical defined OCF Resources (e.g blood pressure measurement)



Device Reset – Hard Reset

- Hard Reset is characterized as a "hard" reset to manufacturer defaults. Hard reset also defines a state where the Device is ready to be transferred to another party.
- A hard reset can be triggered by an authorized OCF Client sending an UPDATE to /oic/sec/pstat setting dos.s = 0 (RESET) or an UPDATE to an instance of /oic/mnt (optional) that supports a 'Factory Reset'.
 - These are functionally equivalent
- Actions to be taken in the Core on an indication being provided to it that a hard reset has been requested:
 - Mandatory Resources: Properties reset to known defaults for oic.wk.d, oic.wk.p
 - Optional Resources: Properties reset to known defaults for oic.wk.con
 - Observes: All active Observe transactions canceled
 - Any resources created on the Device post transition to RFNOP deleted

Device Reset – Observe (established) or In Progress Request Note



- A Server handles an Observe request and informs the Client that the Observe transaction is no longer active by:
 - Sending an appropriate non-success response to the Observer (on the same transaction as the Observe request).
 - Typically a 5.03 (Service Unavailable) with Max-Age



Device Reset – Summary

Function	Actions
SVRs	As per Security Specification
Mandatory Core Resources	Properties in oic.wk.d, oic.wk.p set to defined defaults
Optional Core Resources	Properties in oic.wk.con set to defined defaults
Vertical Resources	Reset to vendor defined defaults
Created Resources	Deleted
Observe Transactions	Canceled with a (typically) 5.03



Versioning

Payload Versioning

- **Purpose:** client and server can understand each others payload.
- **Method:** resource model & encoding information in CoAP header

Device Level Versioning

- **Purpose:** OCF devices can be aware of each others specification implementation version
- **Method:** icv (specification version) in /oic/d resource



Payload versioning

Media Type	ID
application/cbor	60
application/vnd.ocf+cbor	10000

Content-Formats

CoAP Option Number	Name	Format	Length (bytes)
2049	Accept Version	uint	2
2053	Content-Format Version	uint	2

Option Numbers

Version Representation

Bit	Major Version				Minor Version				Sub Version						
	15	14	13	12	11	10	9	8	7	6	5	4	3	2	1

Version Example

OCF version	Binary representation	Integer value
1.0.0	0000 1000 0000 0000	2048
1.1.0	0000 1000 0100 0000	2112



OPEN CONNECTIVITY
FOUNDATION®

Optional Core Technology Core Optional Framework Specification





Core Optional Framework Objectives

- Specifies optional functionality (Resources) that can extend the Core Framework



Device/Platform Configuration (Optional)

- Should a Device support a Client to update configurable information in its "/oic/d" Device Resource, it will expose a device configuration Resource with the "oic.wk.con" Resource Type in the "/oic/res" Discovery Resource
- Should a Device support a Client to update configurable information in its /oic/p Platform Resource, it will expose a platform configuration Resource with the "oic.wk.con" Resource Type in the "/oic/res" Discovery Resource



Device Management (Optional)

- OCF Resources that provides an interested party (clients) to maintain and provide diagnostics for a Device
 - Resource to provide functionality for enabling factory reset, Device reboot, and last Device error information
 - Resource to enable monitoring the current network state of the Device
 - Resource to enable secure software updates for Devices in both managed and unmanaged networks
 - Download initiated by a vendor (e.g., Smart Home usage)
 - Download initiated by end user (e.g., Smart Home usage)
 - Download initiated by network manager (e.g., Industrial usage)



Alerts (Optional)

- An OCF Resource that provides an interested party (clients) with regard to error or other conditions that the Device is experiencing
 - An Alert contains human readable text that is dependent on the Device itself and the condition being reported
 - A Device may expose discrete instances of an Alert Resource
 - A Device may expose zero or more Alert Resources within an Alert Collection
- The primary example of Alerts Resources are for a managing client, such as a service provider, to observe all alerts from all managed Devices



Icons (Optional)

- Icons are a primitive that are needed by various OCF subsystems, such as bridging
- Resource Type of "oic.r.icon" has been defined to provide a common representation of an icon Resource that can be used by Devices and other ecosystems



OPEN CONNECTIVITY
FOUNDATION®

OCF Specification Overview

Core Extension: OCF Cloud

OCF 2.1.0 Release

December 2019





Use Case

- Remote Control/Manage OCF devices based on user authentication
 - User can access OCF devices which belong to or are shared with them regardless of location.
 - User can receive cloud services in conjunction with the registered devices
 - E.g. Device Management, Home security, Energy management, etc
- Usage & Operational Scenario
 1. Jane creates an account in the cloud
 2. Jane registers device resources under the created account
 3. She can control the device anywhere out of the proximal network

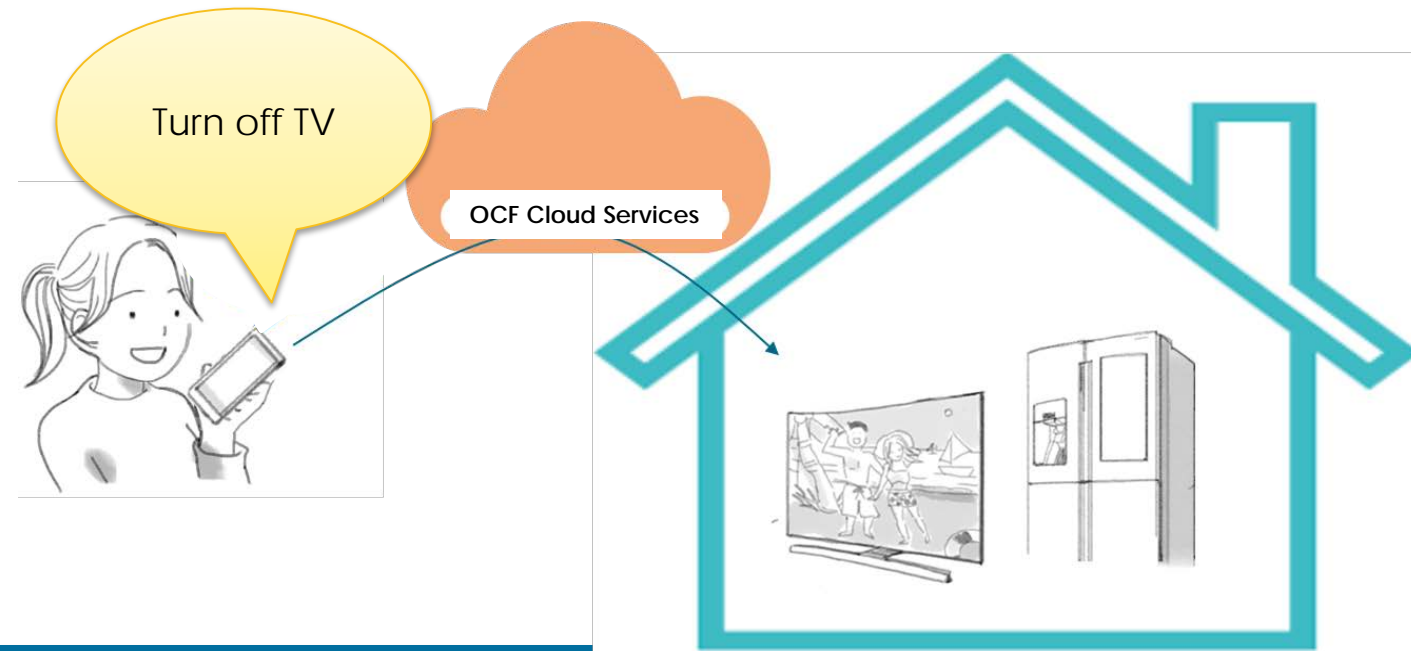



Solution Overview

- OCF defines a logical function (termed "OCF Cloud Services" in this presentation) which allows a Device to register itself "in the Cloud" and thus support remote access applications.
- All communication between the Device and "OCF Cloud Services" is over TLS.
- The logical "OCF Cloud Services" instance is hosted by any vendor that wishes to support the capability.
- OCF itself does not act as an "OCF Cloud Services" host



OCF Device to Cloud Services: Operational Flow

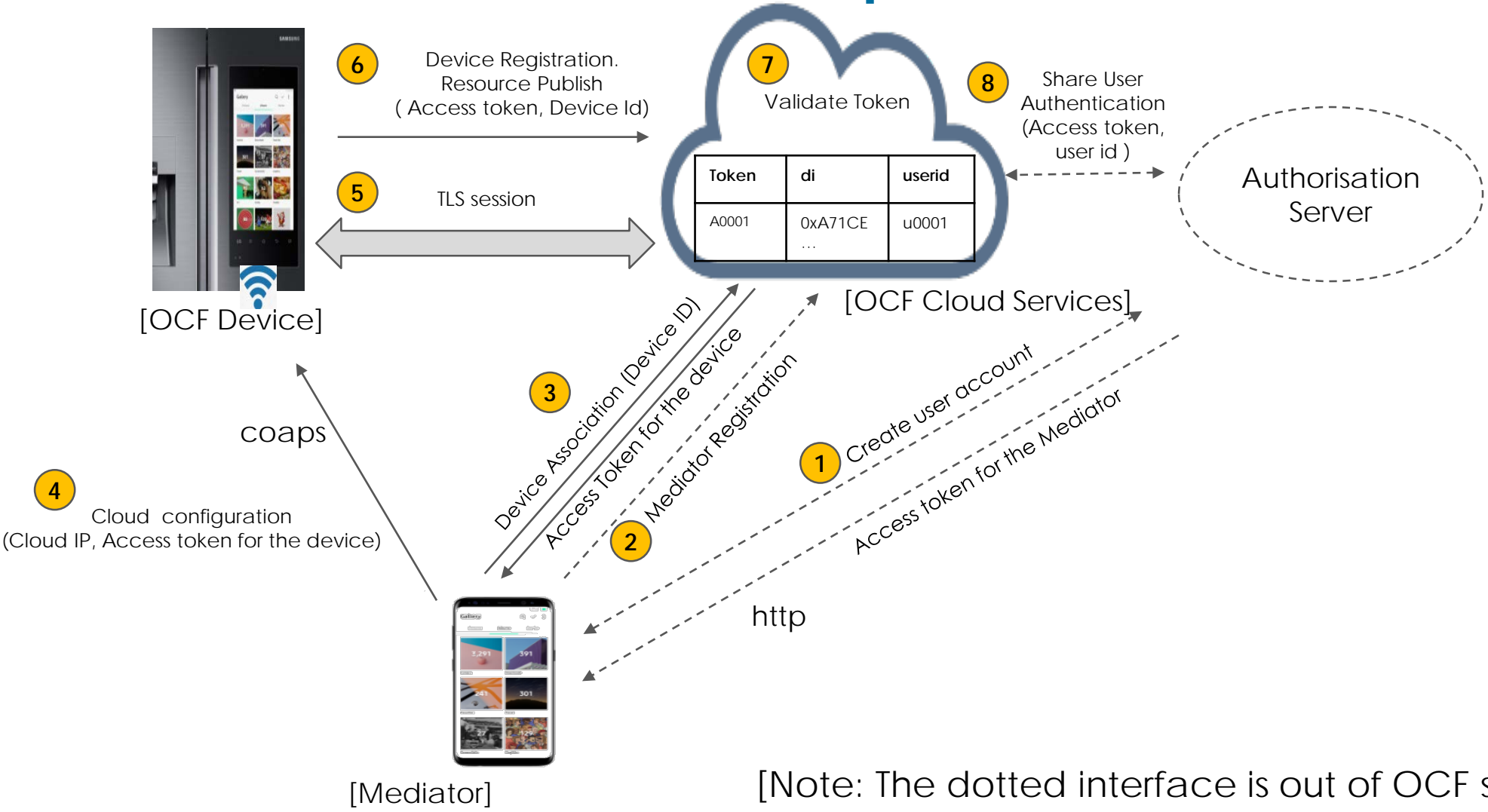



Operational Flow Detail: User Account Creation

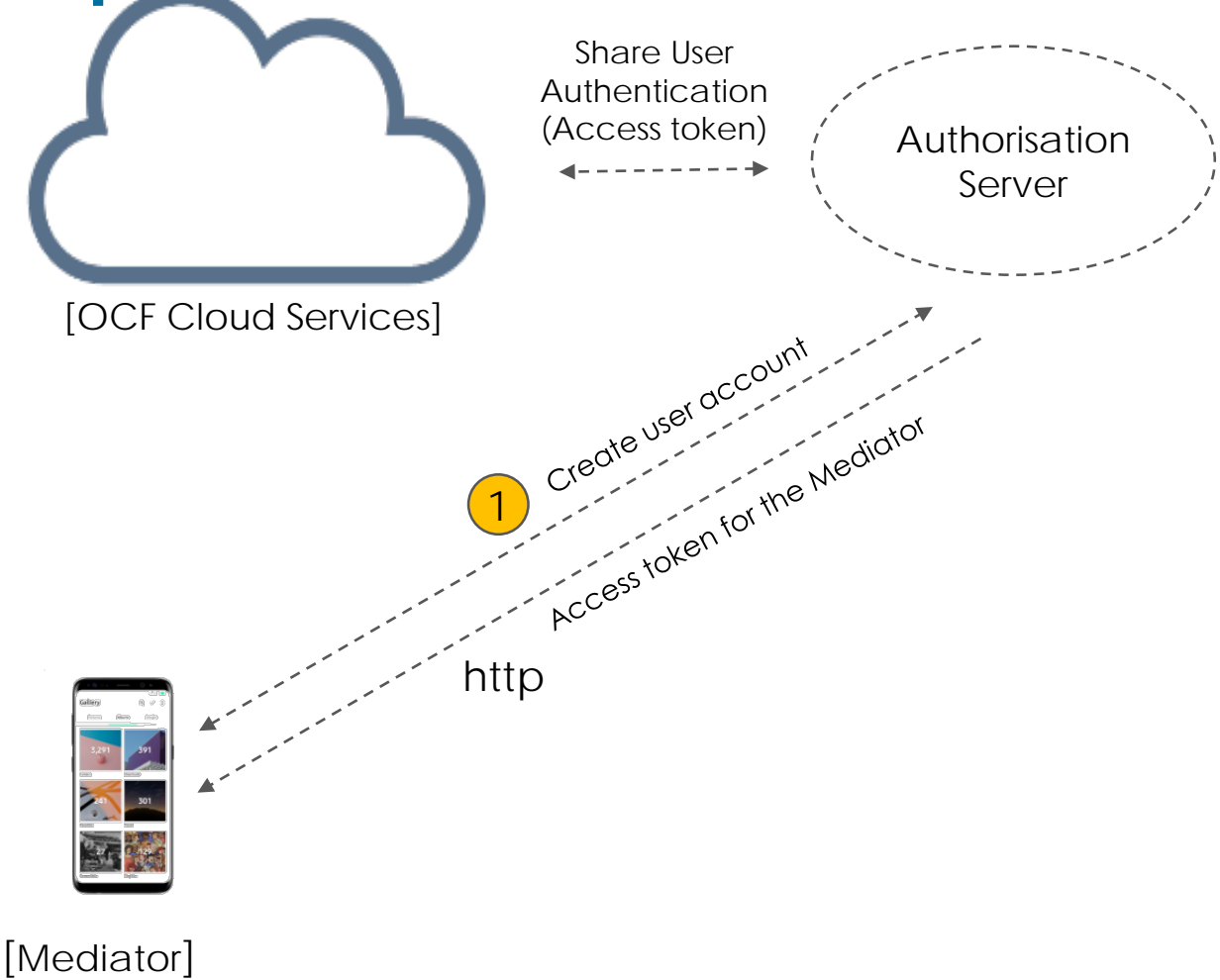

1. The OCF Cloud Services User downloads a Mediator onto their phone which will be used to Provision the Device.
2. The Mediator is configured with or through some out of band process to obtain the URL of the Cloud Service (e.g. the Mediator may be an App from the OCF Cloud Services Provider)
3. The OCF Cloud Services User has access credentials to use the OCF Cloud Services (i.e. user name/password or similar)
 - User can use their 3rd party user account



Operational Flow Detail : Mediator Registration

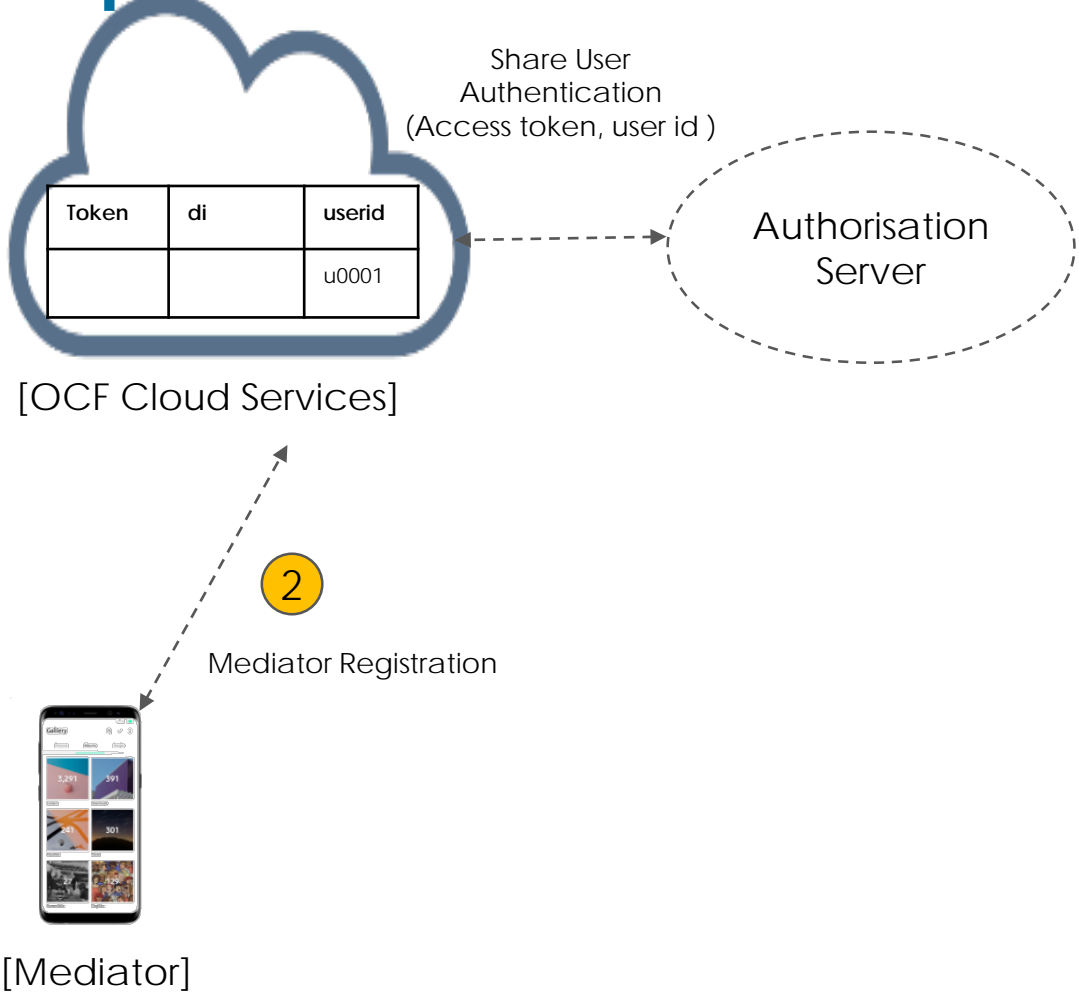

1. The Mediator provides this Access Token to the OCF Cloud Services host.
2. The OCF Cloud Service may also provide a new Access Token (that is different from the Access Token provided by the Mediator). The Mediator is now registered. The "uid" identifies the OCF Cloud Services User. This "uid" is the same for all Mediator instances that may be associated with the OCF Cloud Services User
3. This same user ID can be used to assign multiple Devices to the same OCF Cloud Services User



Operational Flow Detail: Device Association

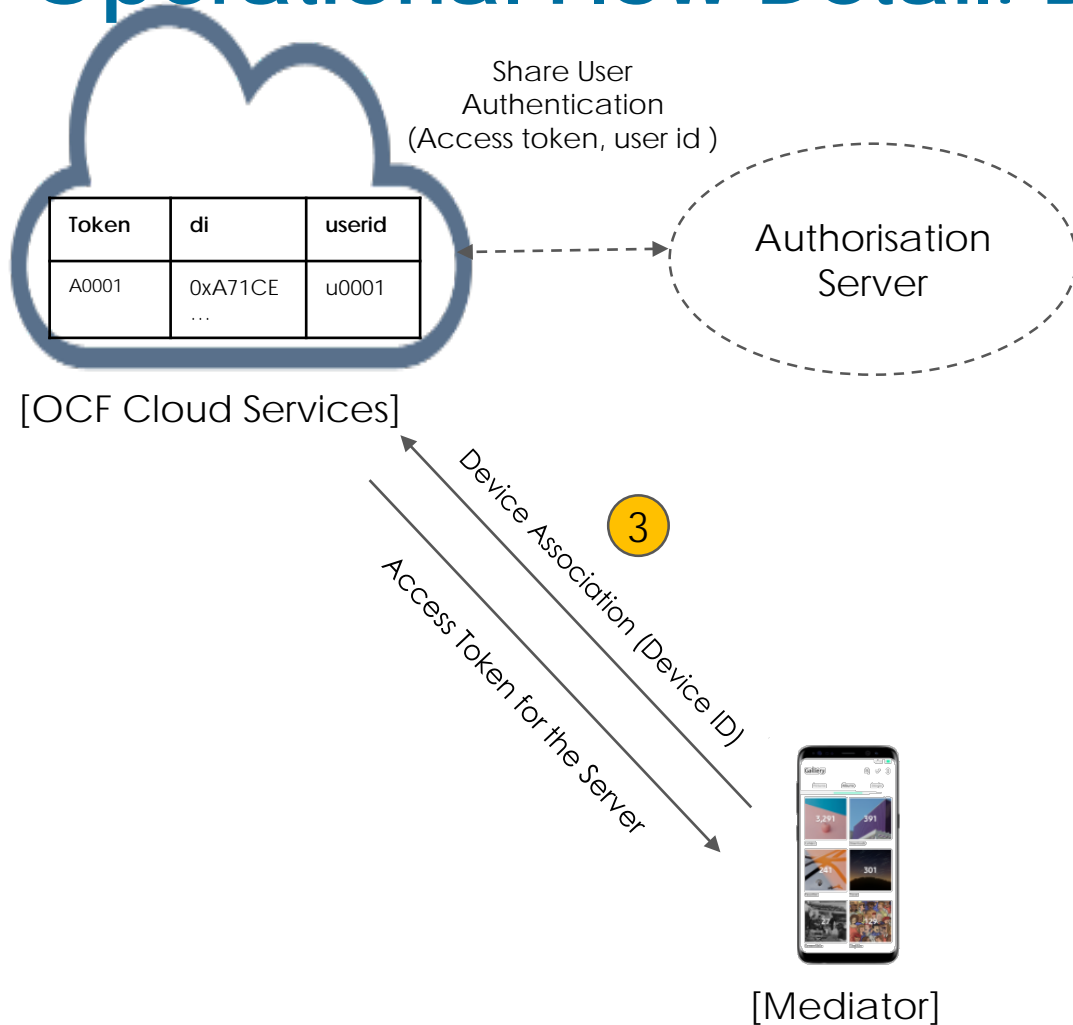

1. The Mediator associated with a User ID requests that the OCF Cloud Services host associates an OCF device with the same User ID by providing the Device ID of desired device
2. The OCF Cloud Services host returns a unique Access Token for the device and maintains a map where the Access Token and the Device ID are stored
3. The Access Token can be created by the OCF Cloud Services host or by an other entity. For the latter case, the OCF Cloud Services host also returns an Authorisation Provider Name("apn") in addition to the Access Token

Operational Flow Detail: Device Provisioning by the Mediator



[OCF Device]

4

Cloud configuration
(Cloud URI Access token)



[Mediator]

1. The Device is configured by the OBT by adding the required ACEs and creds to give the Mediator access to the CoAPCloudConf (CCC) Resource
2. The Mediator connects to the Device through normal OCF Discovery processes.
3. The Mediator updates the CCC Resource on the Device with the Access Token ("at") and OCF Cloud Services URI ("cis"). The Mediator may also provide the Auth Provider Name ("apn").

Operational Flow Detail: Device Registration with OCF Cloud Services

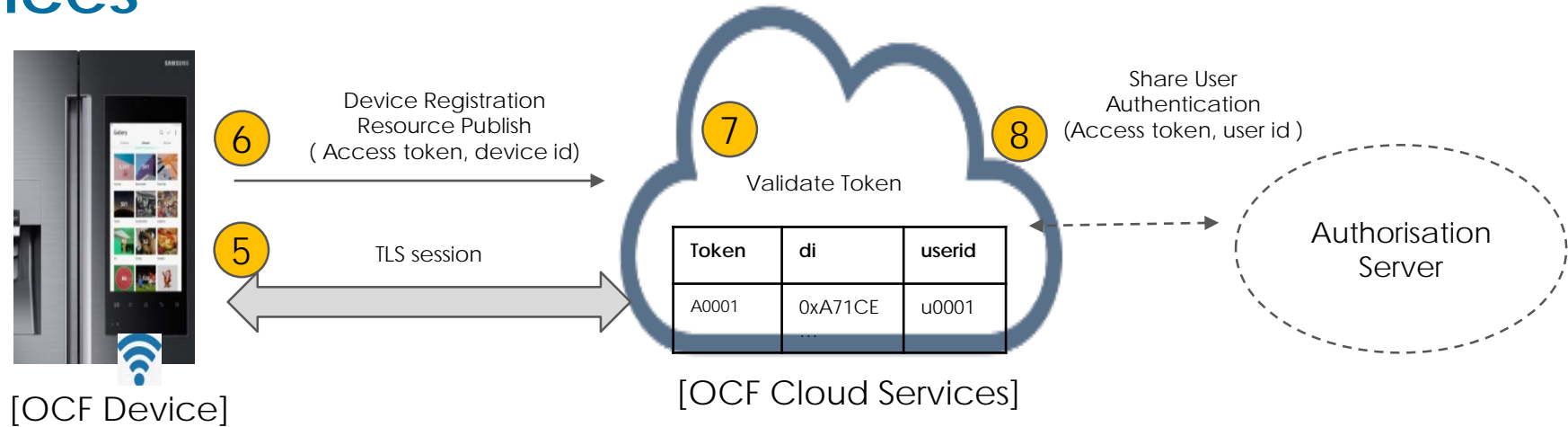

1. The Device establishes a TLS connection with the OCF Cloud Services host using the properties in CCC resource.
2. The Device sends an UPDATE request to the Account Resource which includes the following Properties: "di", "accesstoken", "authprovider"
3. The OCF Cloud Services host ensures that the "di" and the "accesstoken" match its current values. The "accesstoken" value is the same one that the OCF Cloud Services host or Auth provider provided to the Mediator
4. If the values match, the OCF Cloud Services host sends the Account Resource Properties in the UPDATE response
5. If the Device sends a RETRIEVE request to any of the OCF Cloud Services hosted Resources, the Cloud responds with an appropriate error code.



Operational Flow Detail: Login with OCF Cloud Services

1. In order to establish a TLS session and connect to the OCF Cloud Services host to enable passing data between the two, the Device sends an UPDATE request to the Session Resource which includes:
 1. "di" – The value of "di" from "/oic/d" of the Device
 2. "uid" as supplied from the Account Resource UPDATE response
 3. "accesstoken" as supplied from the Account Resource UPDATE response
 4. "login": true
2. The OCF Cloud Services host verifies that the values in the UPDATE request are correct and if so, the Cloud sends a response message that includes the remaining session time ("expiresin").
3. The Device now has an active TCP connection and can exchange data.

Operational Flow Detail: Publishing Links to the OCF Cloud Services RD



1. Once the TLS connection has been established to the OCF Cloud Services host the Device publishes its Resources to the hosted RD function so that they can be seen/accessed remotely.
2. The acl2 and cred Resource of the OCF Device have to be provisioned by the OBT/AMS/CMS/DOTS to give the OCF Cloud Services host the required CRUDN permissions.

Operational Flow Detail: Client to Server Communication through OCF Cloud Services



1. Clients must go through this same process and register with the OCF Cloud Services host. All of an OCF Cloud Services User's Devices (Clients and Servers) will be assigned the access control right associated with the User ID
2. The OCF Cloud Service allows communication between all of a OCF Cloud Services User's Devices based on the fact that they have the same User ID.
3. When the Client attempts CRUDN actions on the Links hosted by the OCF Cloud Services RD, the OCF Cloud Services host forwards those requests to the Device which responds to the OCF Cloud Services host which then gets returned to the Client (i.e. Client -> OCF Cloud Services -> Device -> OCF Cloud Services -> Client).

Operational Flow Detail: Refreshing Connection with OCF Cloud Services



1. When (or before) the "expiresin" timer expires, the Device should refresh its token by sending an UPDATE request to the Token Refresh Resource that includes:
 1. "di"
 2. "uid"
 3. "refreshtoken"
2. The OCF Cloud Services host responds with a new
 1. "accesstoken"
 2. "refreshtoken"
 3. "expiresin"

Operational Flow Detail: Closing Connection with OCF Cloud Services



- If the Device wants to log out of OCF Cloud Services, it sends an UPDATE request to the Session Resource which includes:
 - "di", "uid", and "accesstoken" as supplied from the Account Resource UPDATE response
 - "login": false

Operational Flow Detail: Deregistering from OCF Cloud Services



- The Device sends a DELETE request message to the Account Resource which includes: "accesstoken", "di"
- The OCF Cloud Services host sends a response message confirming that the Device has been deregistered.
 - To connect to the OCF Cloud Services host again, the Device has to be provisioned by the Mediator again and then reregister with OCF Cloud Services



OCF Cloud Services: Resource Directory

- OCF Cloud Services host a Resource Directory to enable indirect discovery:
 - Indirect discovery is when a 3rd party (the Resource Directory), other than the discovering Device and the discovered Device, assists with the discovery process. The Resource Directory only provides information on Resources on behalf of another Device but does not host Resources on part of that Device.

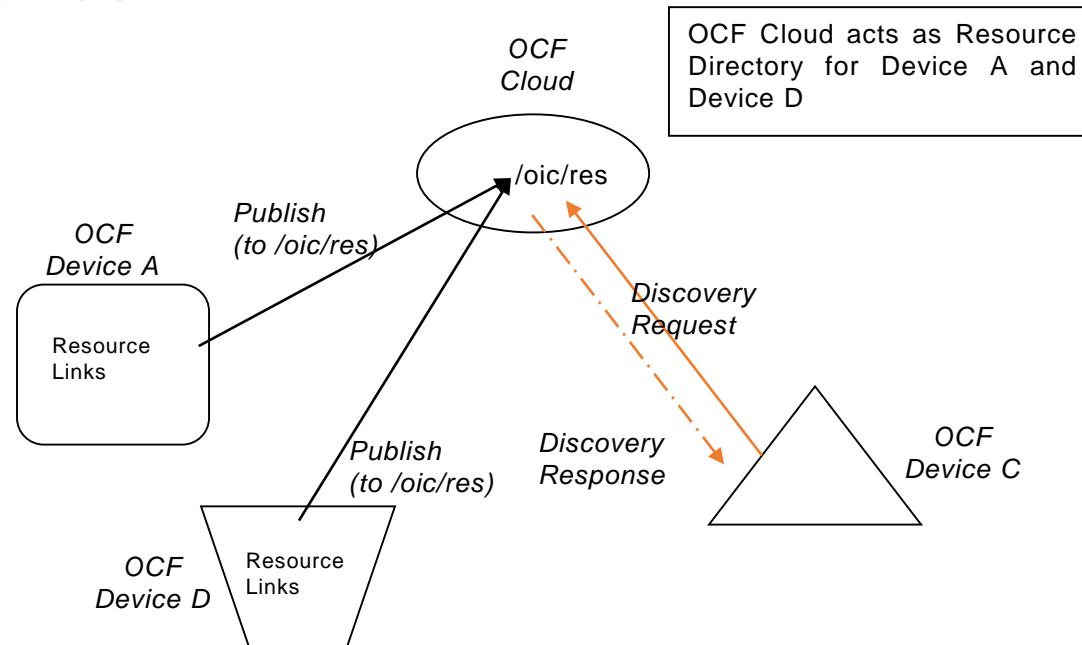

- The OCF Cloud acts as Resource Directory for Device A and Device D.
- Device A and Device D publish their Resource information to the OCF Cloud.
- Device C queries the OCF Cloud to acquire the Resource information of Devices A and D



OCF Cloud Services: Resource Directory

- An OCF Cloud which acts as a Resource Directory (RD) will be involved in the following operations.
 - *RD discovery* – the procedure by which publishing Devices discover an RD, in the case of the OCF Cloud this is a direct result of Device registration with an OCF Cloud.
 - *Resource publish* – the procedures with which Devices publish their Resource information, i.e. Links.
 - *Resource exposure* – the feature with which RDs expose the Links hosted by the 3rd party Devices via their own "/oic/res".
- The ability to host a Resource Directory is indicated by the OCF Cloud exposing an instance of the "oic.wk.rd" Resource Type in its "/oic/res".
 - The discoverable instance of "oic.wk.rd" shall allow only secure connections (e.g. OCF Endpoint with a scheme of "coaps" or "coaps+tcp").



OPEN CONNECTIVITY
FOUNDATION®

Wi-Fi Easy Setup

OCF 2.1.0 Overview





- Easy Setup is the 1st step when a device is unboxed. Specifically for UI-Less devices this is very important step. Wi-Fi Easy Setup spec defines interoperable data model that can be used to configure Wi-Fi connection on a device using a common communication channel. It also provides a standard way of a device proximally advertising its presence for discovery by clients that will perform the configuration. Other than Wi-Fi connection setup, OCF 2.0 specifications optionally provide a way to configure a connection with OCF Cloud Services.
- **Objectives:**
 - Define data model to be used for Easy Setup of an unboxed device.
 - Define spec with standard device beaconing and lost connection behavior.
 - Define Device roles and provide informative flow of operation.
 - Reuse existing security mechanism for Device Ownership and Access Control.

Scenario(s) / Use cases



- Procedure
 - [1] A device is unboxed.
 - [2] Mobile connects to the unboxed device.
 - Using a Soft AP network when Wi-Fi transport is preferred.
 - Mobile transfers Home AP's information and other information.
 - SSID, password, security type of Home AP.
 - [3] Unboxed device connects to Home AP.
 - [4] (*Optionally*) Mobile transfers a cloud access information to the device via Home AP network.
 - [5] (*Optionally*) Unboxed device registers to OCF Cloud Services.



Roles & Definitions



- Easy Setup
 - Process of configuring an Enrollee to an Enroller using a Mediator (by transferring of essential information about the Enroller to the Enrollee).
- Mediator
 - Logical function that enables the Enrollee to connect to the target Network (Enroller). The Mediator transfers configuration information to the Enrollee.
 - Example: Mobile phone/PC
- Enrollee
 - The Device that needs to be configured and connected.
 - Example: Air-conditioner, Printer.
- Enroller
 - The target network entity to which the Enrollee connects.
 - Example: Wi-Fi Access Point
- Soft AP
 - Software Enabled Access Point hosted on the Enrollee which is not a dedicated Access Point.

Resource Model - Structure



- 'EasySetup' resource is a collection
 - Easier to get all resources' properties when a GET request with BATCH_INTERFACE is sent to *conf resources

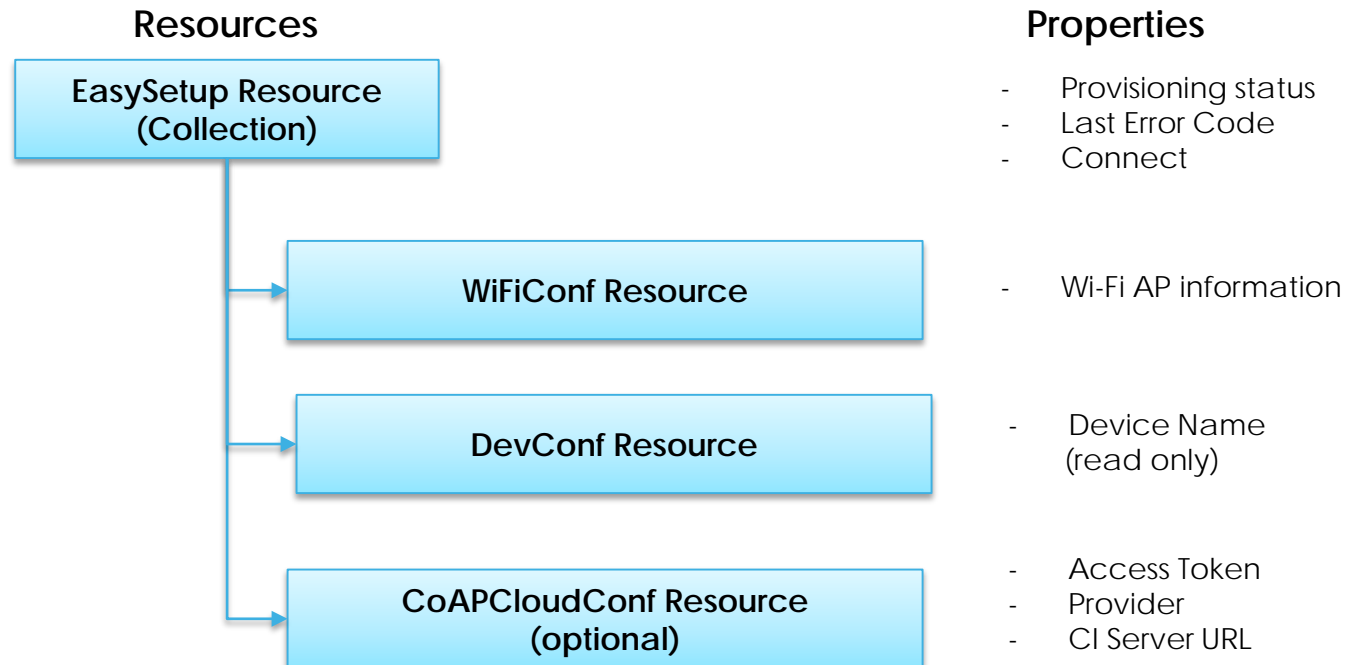

Resource Model: Easy Setup



- Indicates easy setup status

Resource Name	Supported Interface	Example URI	Resource Type	CRUDN permission
EasySetup	Baseline, link-list, batch	/example/EasySetupResURI	oic.r.easyssetup, oic.wk.col	RU

Property	Property Name(key)	Value Type	Value Rule	Access Mode	Mandatory	Description
Easy Setup Provisioning Status	ps	integer	enum	R	Yes	Indicates the easy setup provisioning status of the device (0: Need to Setup, 1: Connecting to Enroller, 2: Connected to Enroller, 3: Failed to Connect to Enroller, 4-254: Reserved, 255: EOF)
Last Error Code	lec	integer	enum	R	Yes	Indicates a failure reason if it fails to connect to Enroller (0: NO error, 1: A given SSID is not found, 2: Wi-Fi password is wrong, 3: IP address is not allocated, 4: NO internet connection, 5: Timeout, 6: Wi-Fi Auth Type is not supported by the Enrollee, 7: Wi-Fi Encryption Type is not supported by the Enrollee, 8: Wi-Fi Auth Type is wrong (failure while connecting to the Enroller), 9: Wi-Fi Encryption Type is wrong (failure while connecting to the Enroller), 13-254: Reserved, 255: Unknown error)
Connect	cn	array of integer		RW	Yes	Indicates an array of connection types that trigger an attempt to connect to the Enroller to start (1 : Wi-Fi, 2 : Other transport to be added in a future (e.g. BLE))

Easy Setup – Wi-Fi Conf. Resource



- Contains Wi-Fi-related properties

Resource Name	Supported Interface	Example URI	Resource Type	CRUDN permission
Wi-Fi Conf.	Read Write, Baseline	/example/WiFiConfResURI	oic.r.wificonf	RU

Property	Property Name(key)	Value Type	Value Rule	Access Mode	M / O	Description
Supported Wi-Fi Mode Type	swmt	array of string	enum	R	M	Indicates supported Wi-Fi mode types. It can be multiple. (i.e. "A", "B", "G", "N", "AC")
Supported Wi-Fi Freq.	swf	array of string		R	M	Indicates supported Wi-Fi Frequency by Enrollee. Can be multiple. (i.e. "2.4G", "5G")
Target Network Name	tnn	string		RW	M	Indicates SSID of Wi-Fi AP i.e. Enroller.
Credential	cd	string		RW	M	Indicates credential information of Wi-Fi AP (password used to connect to enroller).
Wi-Fi Auth Type	wat	string	enum	RW	M	Indicates Wi-Fi Auth Type (i.e. "None", "WEP", "WPA-PSK", "WPA2-PSK")
Wi-Fi Encryption Type	wet	string	enum	RW	M	Indicates Wi-Fi Encryption Type (i.e. "None", "WEP_64", "WEP_128", "TKIP", "AES", "TKIP_AES")
Supported Wi-Fi Auth Type	swat	array of string	enum	R	M	Supported Wi-Fi Auth types. Can be multiple. ("None", "WEP", "WPA_PSK", "WPA2_PSK")
Supported Wi-Fi Encryption Type	swet	array of string	enum	R	M	Supported Wi-Fi Encryption types. Can be multiple. ("None", "WEP-64", "WEP_128", "TKIP", "AES", "TKIP_AES")

Easy Setup – Dev Conf. Resource



- Store all device configuration required in easy setup process
- Store a device name used in easy setup process

Resource Name	Supported Interface	Example URI	Resource Type	CRUDN permission
Device Conf.	Read Only, Baseline	/example/DevConfResURI	oic.r.devconf	RU

Property	Property Name(key)	Value Type	Value Rule	Access Mode	M / O	Description
Device Name	dn	one of: string or array of object		R	M	<p>Indicates a pre-configured device name in language indicated by 'dl' in /oic/con.</p> <p>or</p> <p>An array of objects where each object has a 'language' field (containing an IETF RFC 5646 language tag) and a 'value' field containing the pre-configured device name in the indicated language.</p> <p>The pre-configured device name is presented by enrollee to mediator during easy-setup process.</p>

Example Easy Setup Flow (informative)

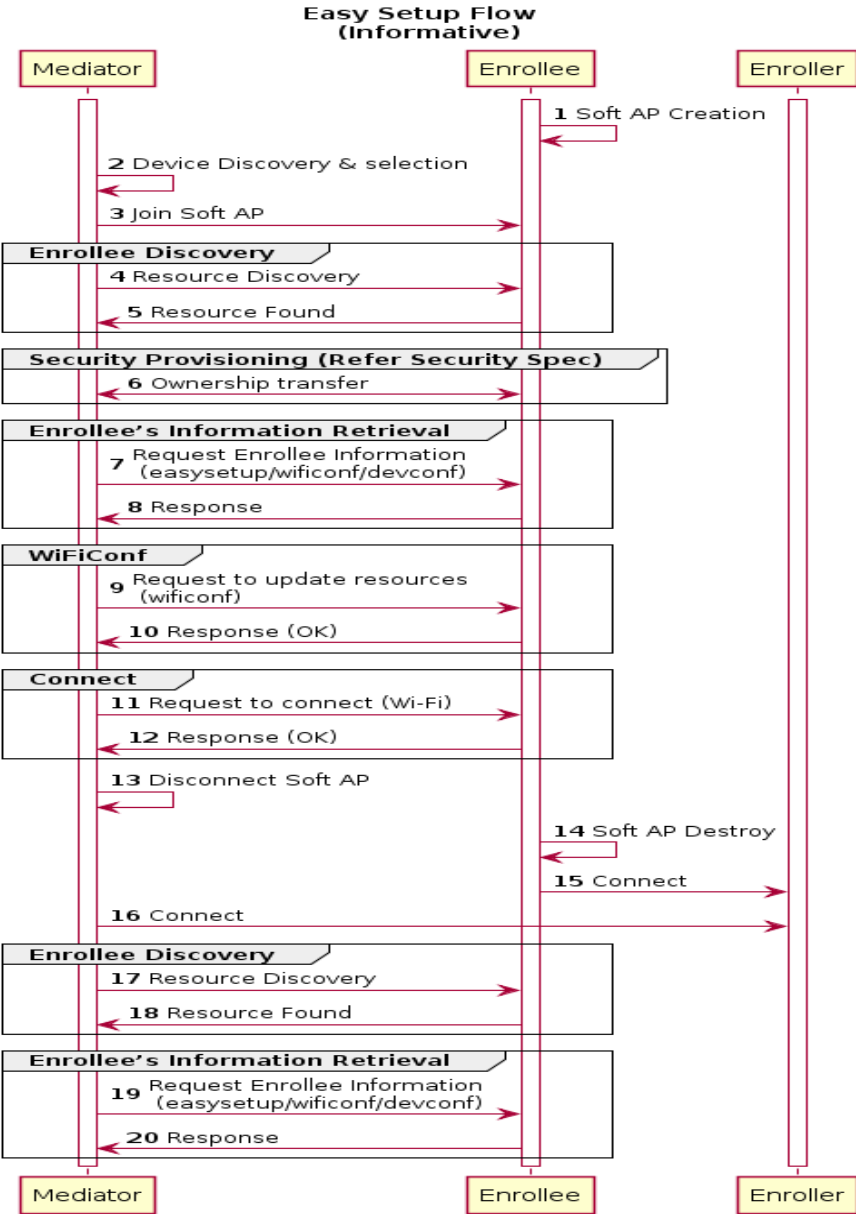

Step1: Enrollee enables SoftAP
 Steps 2-3: Mediator connects via the SoftAP
 Enrollee Discovery: Steps 4-5:
 Mediator discovers the Enrollee OCF Resources
 Security Provisioning: Step 6:
 Ownership Transfer
 Enrollee Information Retrieval: Steps 7-8:
 Mediator Retrieves Configuration Resources
 Wi-Fi Configuration: Steps 9-10:
 Mediator Updates Configuration Resources
 Network Connect: Steps: 11-16
 Mediator instructs Enrollee to connect to configured Wi-Fi
 SoftAP disconnect and disablement
 Enrollee Discovery and Retrieval: Steps 17-20:
 Mediator discovers via Wi-Fi network



OPEN CONNECTIVITY
FOUNDATION®

OCF Specification Overview Security Specification

OCF 2.1.0 Release





OCF Security Summary

- OCF is concerned with
 - **Device Identity** (Immutable, Unique, Attestable)
 - **Onboarding** (including **Authentication, Authorization, & Auditing (AAA)**)
 - **Confidentiality** (Protect data and communications)
 - **Integrity** (Resources, device state, and transitions are all managed)
 - **Available** (not only at the device level but also secured so they don't impact the networks within which they operate)
 - **Lifecycle Management** (Including secure software update and verifications mechanisms)
 - **Future Security** (Looking at credential types, algorithms, and adapting to changes in the security landscape as it relates to the security of OCF devices, now and in the future)
- OCF key management supports device protection and authentication
- OCF uses Access Control Lists (ACLs) to manage authorization
- Secure device ownership transfer helps prevent attacks when devices are added to the network



Security Principals

- **Resources:** a data structure that defines the types, data and interfaces of a device; each can be Created/Retrieved/Updated/Deleted or to which Notification can be set based on appropriate access control
- **Access Control Entries (ACEs) and Access Control Lists (ACLs)** are entries and collections, respectively, of permissions granting one device access to a Resource.
- **Onboarding Tools (OBTs)** are OCF Devices that help bring other OCF Devices into the local network. The OBTs are collections of services, some of those are listed below:
 - **Access Manager Service (AMS, oic.d.ams)** creates and verifies access control permissions.
 - **Credential Management Service (CMS , oic.d.cms)** is the name and resource type for a device which is granted permission to create and manage security credentials.
 - **Mediator** provisions the OCF Device with information necessary for remote service management.
 - **Device Ownership Transfer Service (DOTS , oic.d.dots)** onboards the OCF Device.
 - **Ownership Transfer Mechanism (OTM)** is method of onboarding (e.g. using cert for authentication).
- **Secure Virtual Resources (SVRs)** are special security resources with severely restricted permissions and access management.



How OCF Security Protects Device Resources:

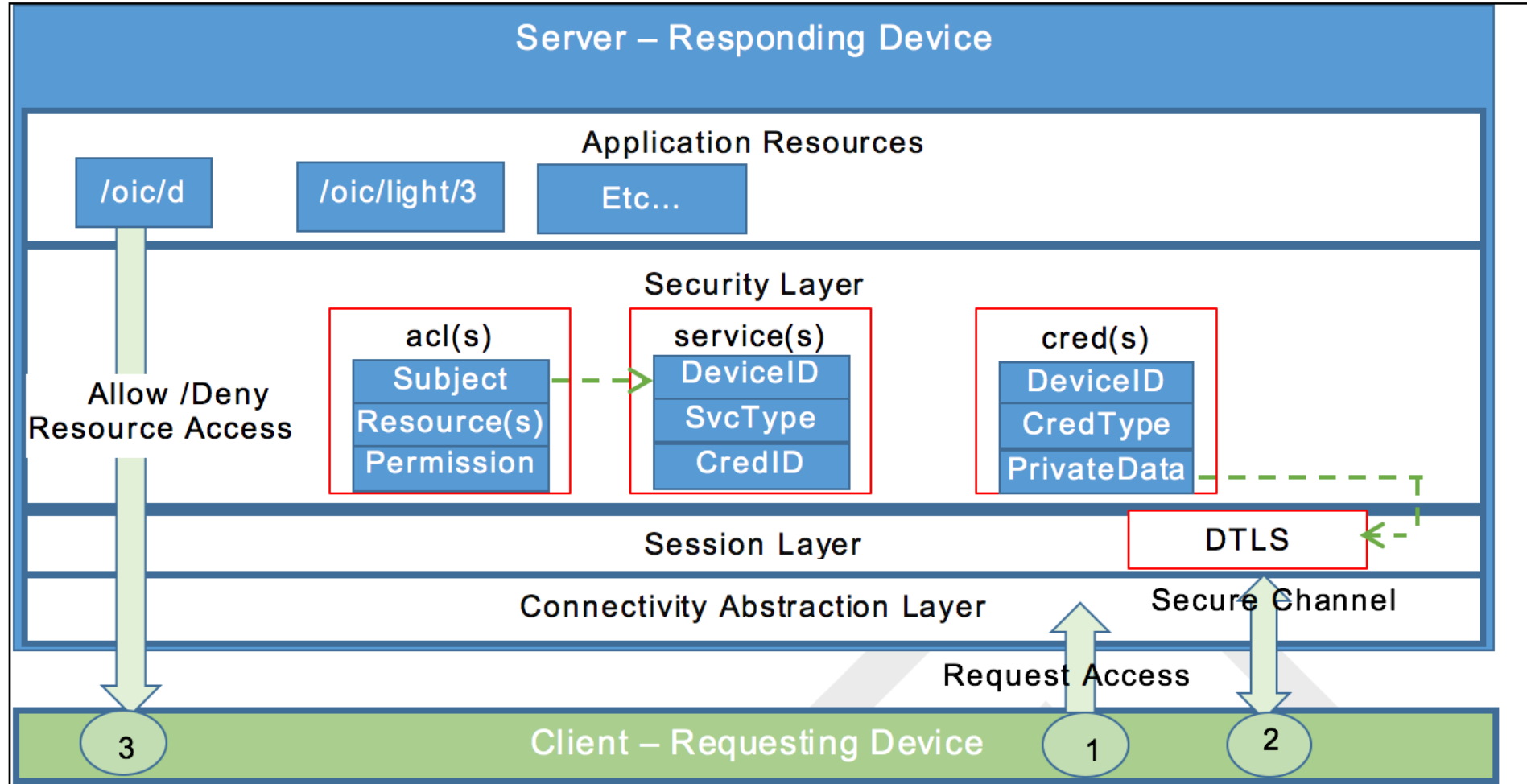



Simplified Onboarding Sequence

- *Unowned Device boots*
- **Discovery (unsecured):**
 - DOTS sends multicast to discover unowned devices no TLS
 - Unowned devices reply, including list of supported OTMs no TLS
- **Ownership Transfer:**
 - DOTS selects and configures this OTM to the new device no TLS
 - DOTS & unowned Device perform OTM, inc. TLS handshake TLS
 - DOTS configs SVRs to authorize itself, CMS and AMS TLS
 - *Device is now owned!*
- **Provisioning:**
 - CMS provisions credentials, AMS provisions access policies TLS
 - *Device is now provisioned and can commence normal operation*
- **Normal Operation:** TLS or no TLS
 - *Credentials and/or access policies can be updated by returning to Provisioning*



Device Provisioning States

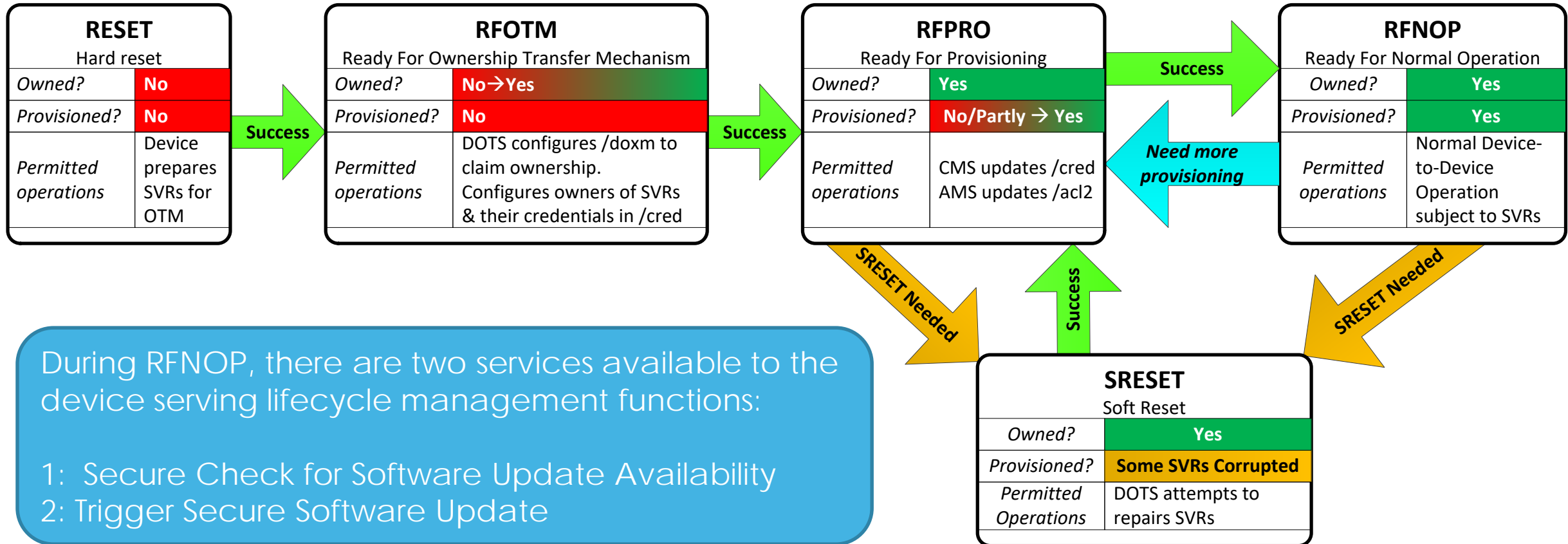

Device can transition to **RESET** from any state (these transitions are not shown)



Credential Management

- OCF devices can support the use of both symmetric and asymmetric credentials for establishing secure communication
 - Symmetric Key is mandatory
 - Certificates public/private keys are supported
 - CMS must be able to support both
- Missing credentials could be procured from a CMS
- Credentials may have an expiration period
 - Expired credentials can be refreshed



Access Control

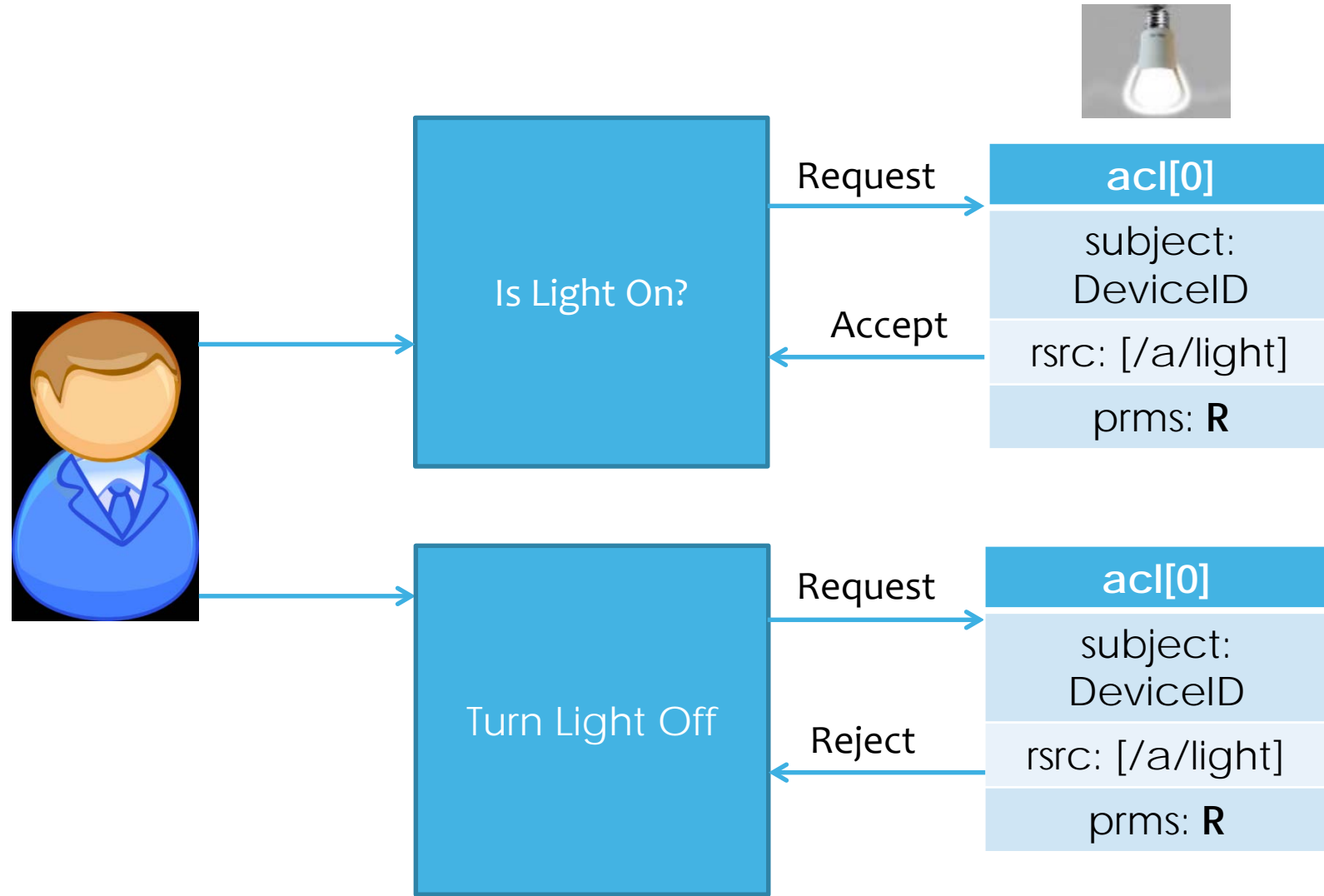



Access Control

- Protect Resources of the OCF Server to control CRUDN access for entity requesting access
 - Any request to the OCF Server is subject to ACL(Access Control List) policy check
 - ACE (Access Control Entry) policy applies to a OCF Server hosted Resource
 - Each ACE has a permission which allows read or write operation
- Two type of access control mechanism are supported:
 - Subject-based access control (SBAC)
 - ACE specifies the identity of requestor
 - Role-based Access Control (RBAC)
 - ACE specifies the role to accept of the entity requesting access
- ACL can be changed/updated via the AMS
 - Wildcards are supported to ease ACL management
- ACL policies applies only at the OCF server side
- When Client is authorized to CREATE a Resource in a Collection, Server autonomously changes ACL to give Client full read/write access that Resource



Security Virtual Resource (SVR)

- OCF defines SVRs (Security Virtual Resource) to perform OCF security related functionality
 - “Virtual” is an artefact of legacy resource naming. It is in fact a full-fledged OCF resource
- Device Ownership Transfer Resource (/oic/sec/doxm) manage Device Ownership status
- Provisioning Resource (/oic/sec/pstat) manage Device Provisioning status
- Credential Resource (/oic/sec/cred) manages Device credentials
 - Credential Resource is used for establishing secure communication
 - For oic.sec.cred.trustca entries, also known as trust anchors for identity certificates, Subject ID has to match the ID of connecting OCF Device
 - Subject ID is used to verify identity of the OCF Devices and can be matched to ACLs
- Access Control List (/oic/sec/acl2) manages the Access Control Entry for the Resource Server



Security Virtual Resource (SVR)

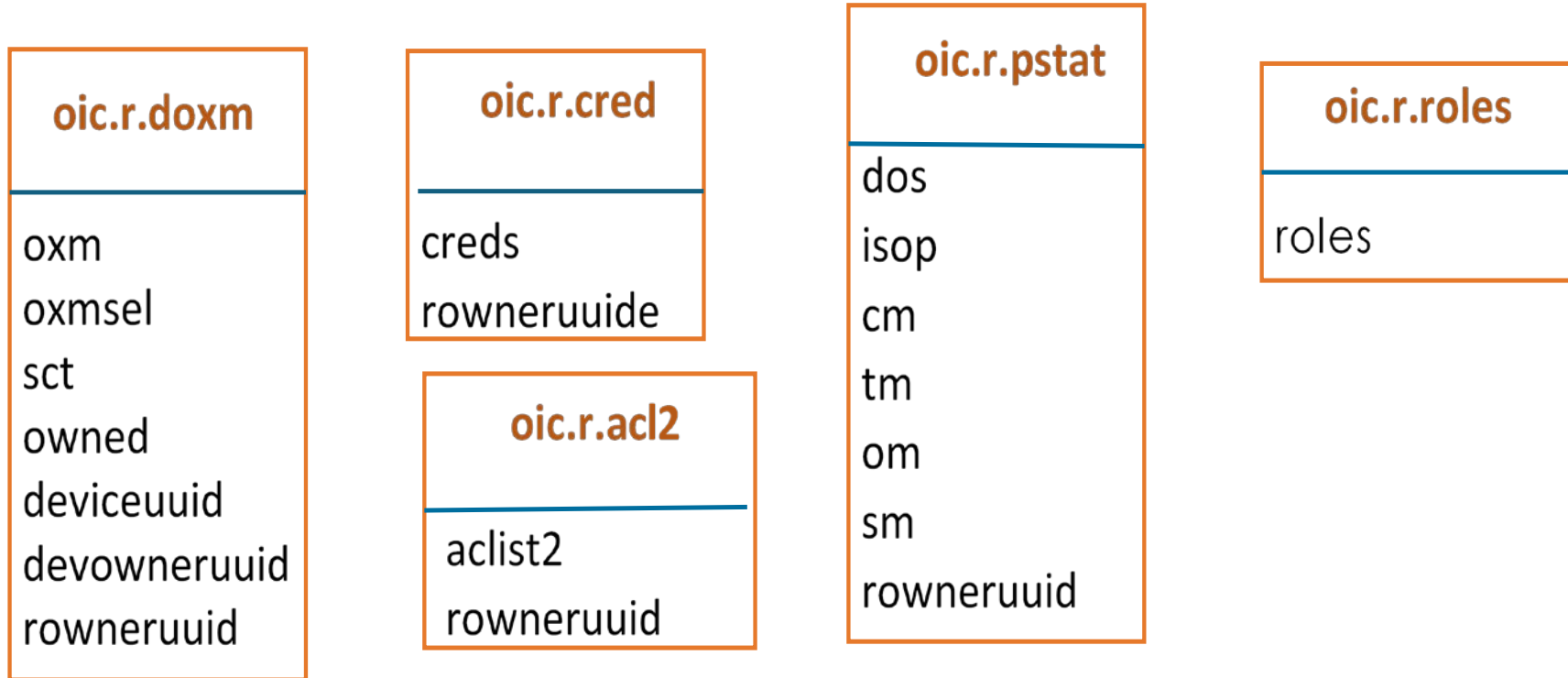



Message Integrity and Confidentiality

- Secured communications between OCF Devices are protected against eavesdropping, tampering, and message replay.
- Unicast messages are secured using DTLS or TLS. Multicast messages are not secured.
- All communications are signed and encrypted.
- Communicating devices are required to authenticate each other. Communicating devices need to have useable credentials to talk to each other. If they are missing, the devices could contact the CMS to get them.



3 New Security Profiles for OCF 2.0

Independent improvements to Baseline

"Purple"
Enhanced Device robustness requirements

"Black"
OCF PKI Certificates Required

"Blue"
OCF Certification Status Check at Onboarding Time

Certificate-based Onboarding

Baseline Security

Shared Key Onboarding

Anonymous Onboarding

- **Optional and Certifiable improvements to Baseline Security Profile**
 - Black requires an audited CA, Blue/Purple require a vetted CA. All three include significant improvements to Device security such as hardware key storage, improved cipher suite support, etc.
 - A Device may be certified as conforming to any combination of Profiles. (e.g. Blue & Purple; Black only; Black & Blue & Purple; etc.)
- **Interoperable:** Devices of different Profiles can co-exist and interoperate.
- **Cryptographically Attestable:** Certificate extensions allow encoding of security attributes and OCF certification information.
- **Consistent:** No change to OCF branding due to Security Profiles.



Manufacturer Incentives to Use Security Profiles

- Purple: Manufacturer building a Device with requirement for measured boot and secure SW update, to improve device integrity (e.g. connect to cloud, healthcare or government).
- Black: Manufacturer wishing to require use of OCF PKI, which ensures certificates are signed by OCF PKI, and meet OCF Certificate Policy.
- Blue: Manufacturer wishing to use its own (or other non-OCF) CA, which must conform to OCF-defined CA vetting criteria.

"Purple"
Enhanced Device
robustness requirements

"Black"
OCF PKI Certificates
Required

"Blue"
OCF Certification Status
Check at Onboarding Time



Additional Commentary on Security Profiles

- The **BLACK** profile requires use of the OCF PKI, using certificates that all share a common OCF root. Issuance of a black-profile Certificate requires that the Device has passed OCF certification, and requires that the CA issuing the certificates undergoes a successful audit of their CA process (OCF Certificate Policy based on WebTrust for Certificate Authorities v2.1).
- The **BLUE** profile has certificates issued by CAs that have passed a successful audit of their CA process. The Certification Status of the Device is verified at onboarding time against the OCF's Certification Management System. Currently, an extensible model for distributing audited CA's public roots to the OBTs is under design, but shorter-term, a list of vetted Roots can be found in the OCF Security Specification.
- The **PURPLE** profile adds some additional attestations that the manufacturer is asserting, related to the integrity of the device. These attestations are on file with the OCF Certification Working Group, and are identified specifically inside the Certificate.
- For further details on the granular differences between these profiles, please see the OCF Security Specification v2.0.2



OCF Cloud (optional feature)

OCF Cloud enables Device interaction with cloud-hosted Resource Directory

3 SVRs are hosted on the cloud:

- Account
- Session
- Token refresh

User ID is used as a basis for access control; authentication is performed using token received from cloud during Device registration

Initial Device provisioning for cloud connection is performed by the Mediator service. Mediator is usually hosted by OBT

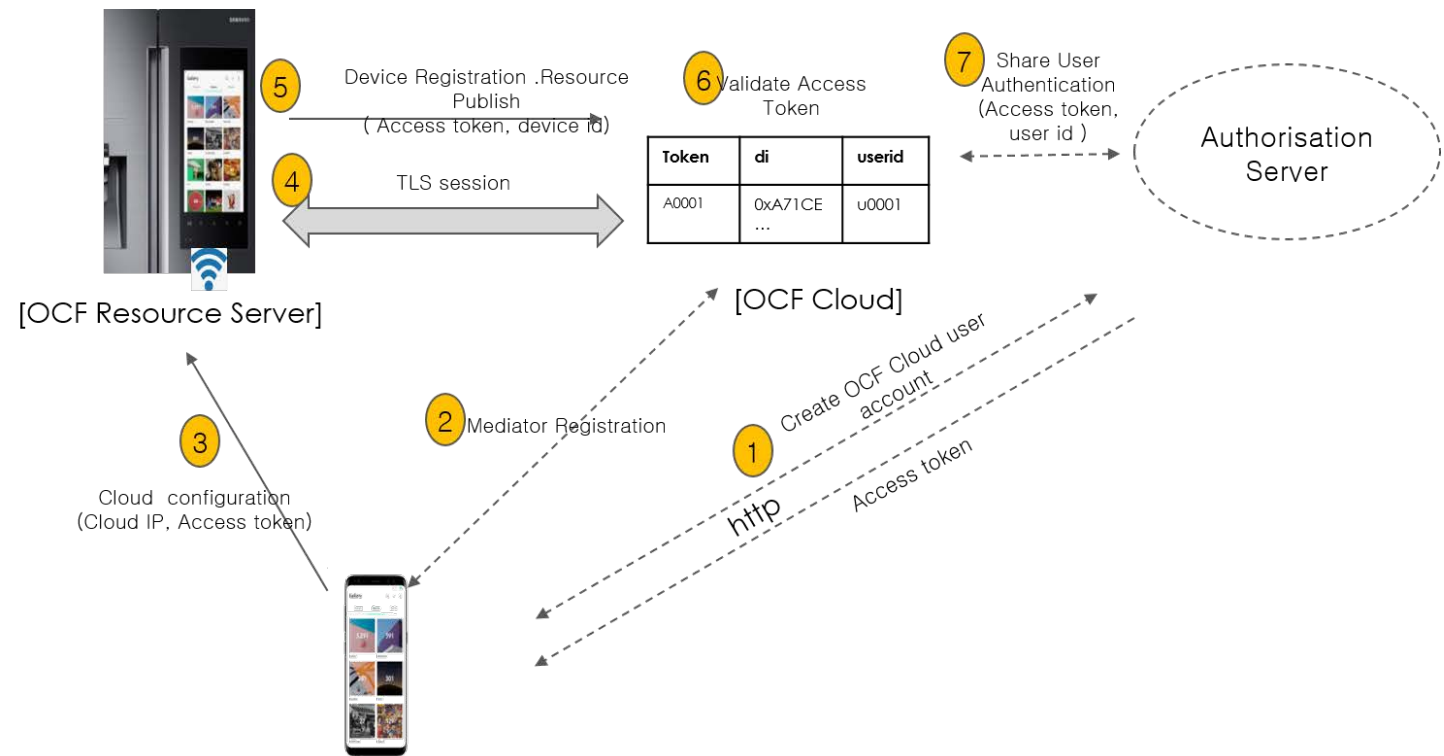



OCF Bridging

OCF provides opportunity for OCF-vetted ecosystems to integrate into OCF ecosystem by implementing the **Bridging Function**

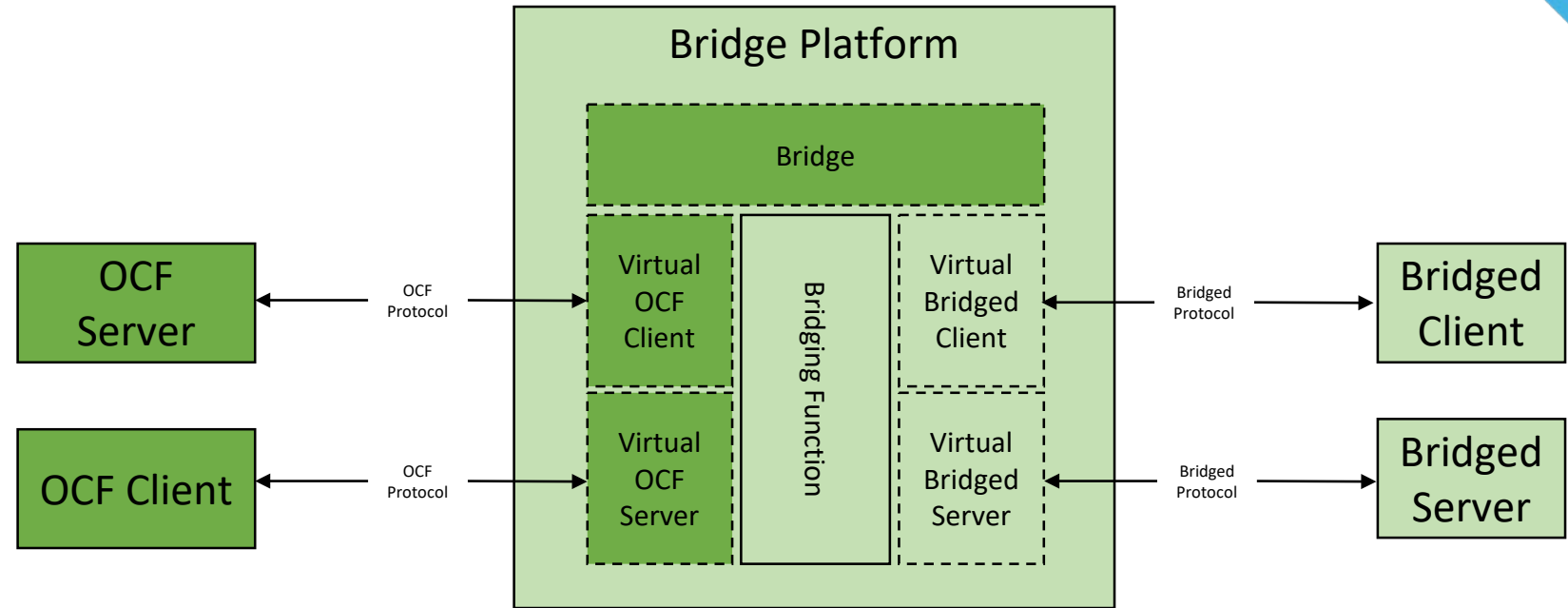

Bridge and Virtual OCF Device (VOD) are mostly independent OCF Devices, except:

- VOD can not be Owned, if Bridge is Unowned
- When Bridge becomes Unowned, Unowned VODs shall drop DTLS connections
- VOD may use manufacturer credentials hosted by Bridge

VOD is indistinguishable from OCF device, but has additional "oic.d.virtual" Device Type



Best Practices and Attestations

- Some security practices fall outside of our ability to test as part of OCF certification process.
- These are included in the Best Practices section of the Security specification. This section is not intended to be comprehensive, but is intended to provide guidance.
- Certification process requires signing of an OCF Attestation Document, which addresses specific security practices to which the manufacturer asserts compliance.



OPEN CONNECTIVITY
FOUNDATION®

Infrastructure: Bridging Specification

OCF 2.1.0 Overview





Relationship between OCF Bridging Specs and Others

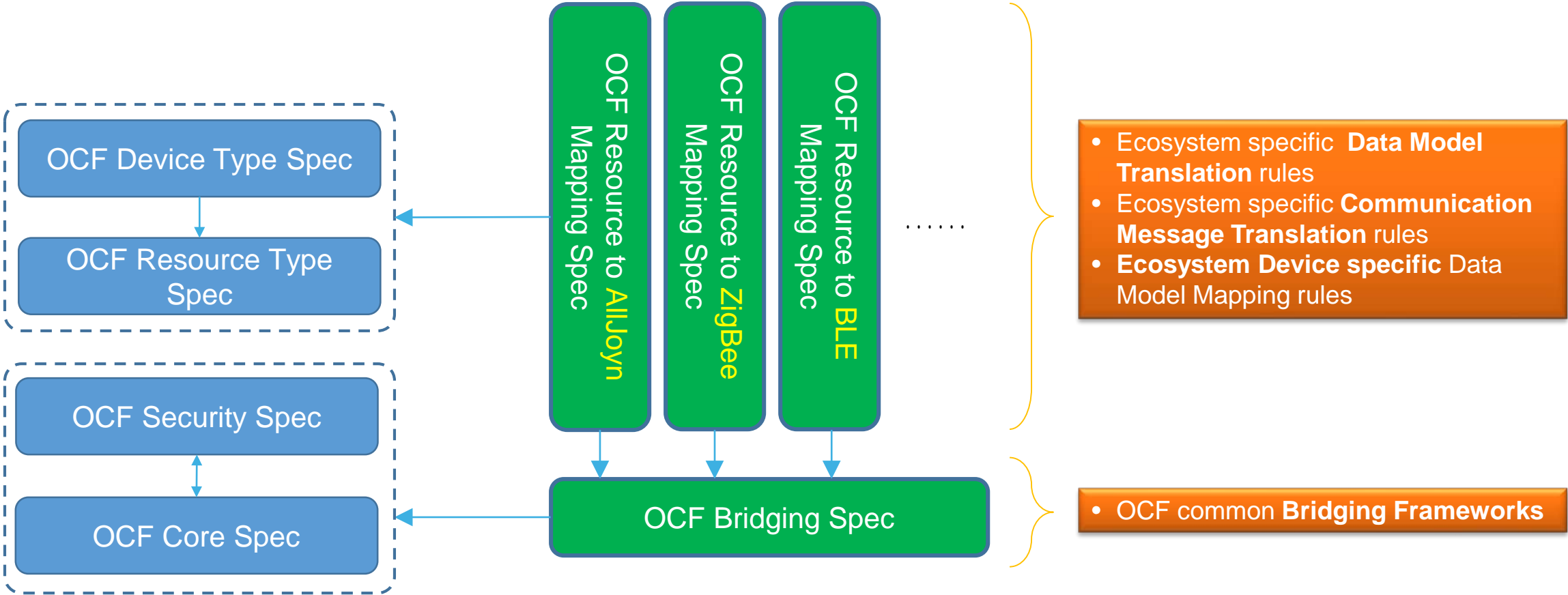



OCF Bridging Specification

- Specifies a **framework** for **Asymmetric** / **Symmetric** translation between devices in OCF and non-OCF ecosystems.
 - In symmetric bridging, a bridge device exposes OCF Server(s) to another ecosystem and exposes other ecosystem's server(s) to OCF. In asymmetric bridging, a bridge device exposes OCF Server(s) to another ecosystem or exposes another ecosystem's server(s) to OCF, but not both.
- Provides **general requirements** for translation between OCF and non-OCF ecosystems
 - Requirements for resource discovery, message translation, security, etc



OCF Resource to XXX Mapping Specifications

- Provides **specific requirements** for translation between OCF and **specific ecosystems**
 - Ecosystem specific Data Model Translation rules to/from OCF
 - Ecosystem specific Communication Message Translation rules to/from OCF
 - Ecosystem Device specific Data Model Mapping rules to/from OCF
- The Mapping Specifications for following ecosystems currently exist:
 - AllJoyn
 - oneM2M
 - ZigBee
 - BLE
 - Z-wave
 - (Haier) U+



OCF Bridging Specification – Definition

- An OCF Bridge is a device that represents one or more non-OCF Devices (Bridged Devices) as “**Virtual OCF Devices**” on the OCF network and represents one or more OCF-Devices as “**Virtual Bridged Devices**” on the non-OCF network
- The Bridged Devices themselves are out of the scope of OCF.
- A “regular” OCF Device and a Virtual OCF Device are exactly same except that the Virtual OCF Device has “**oic.d.virtual**” as its “rt” value.
- An OCF Bridge is indicated on the network with an “rt” of “**oic.d.bridge**”.



OCF Bridging Specification – Definition

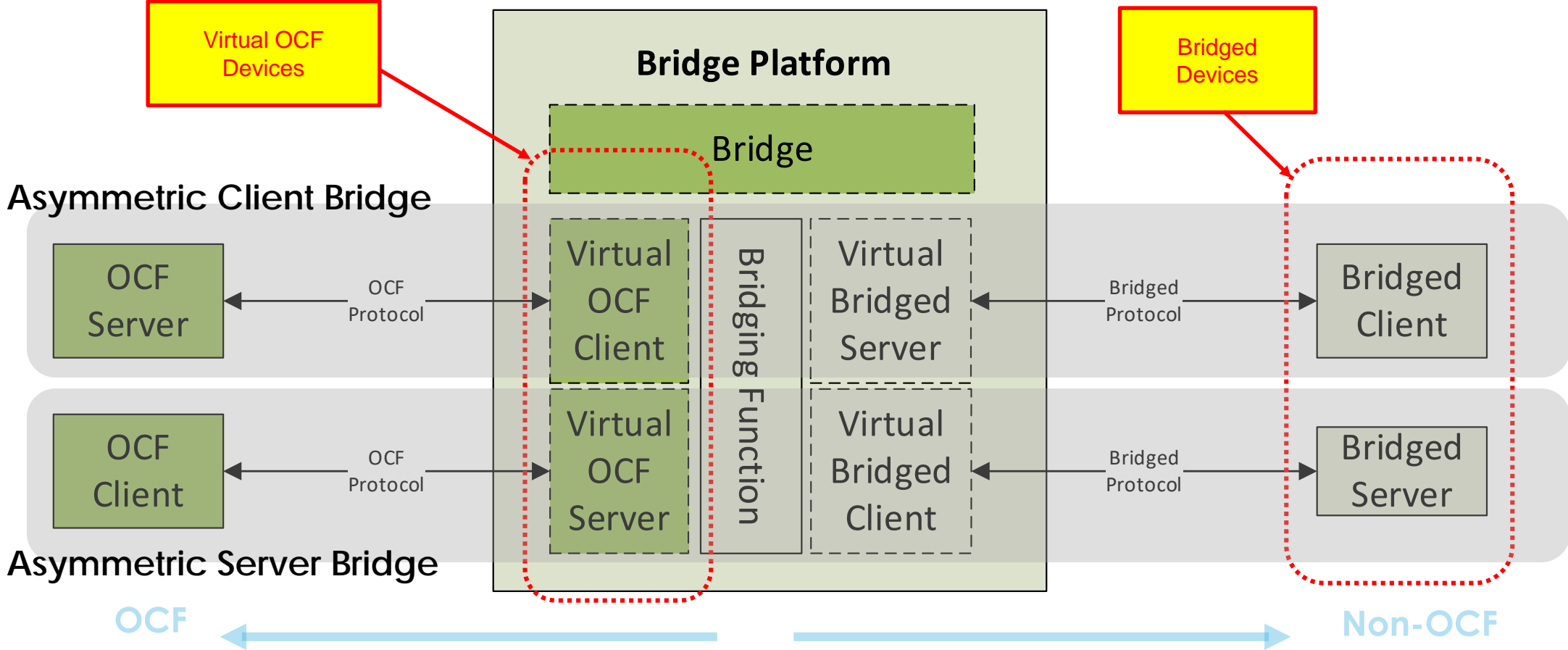



OCF Bridging Specification – Definition

- An OCF Bridge exposes an instance of a **VODList (Virtual OCF Device List)** Resource ("**oic.r.vodlist**") which contains information about all Virtual OCF Devices (Clients or Servers) that are exposed by the OCF Bridge.
- For example consider an OCF to Zigbee Bridge that exposes a single Zigbee Thermostat as a Virtual OCF Device (Server), then the instance of "oic.r.vodlist" may be populated as shown:

```
{
  "vods": [
    {
      "n": "My Zigbee Thermostat",
      "di": "54919CA5-4101-4AE4-595B-353C51AA5678",
      "econame": "Zigbee"
    }
  ]
}
```



OCF Bridging Specification – Definition

- Bridging example (Asymmetric Server Bridge)
 - Light and Fan are non-OCF Devices
 - Light and Fan are exposed as “**Virtual OCF Devices**” to OCF Devices by the Bridge

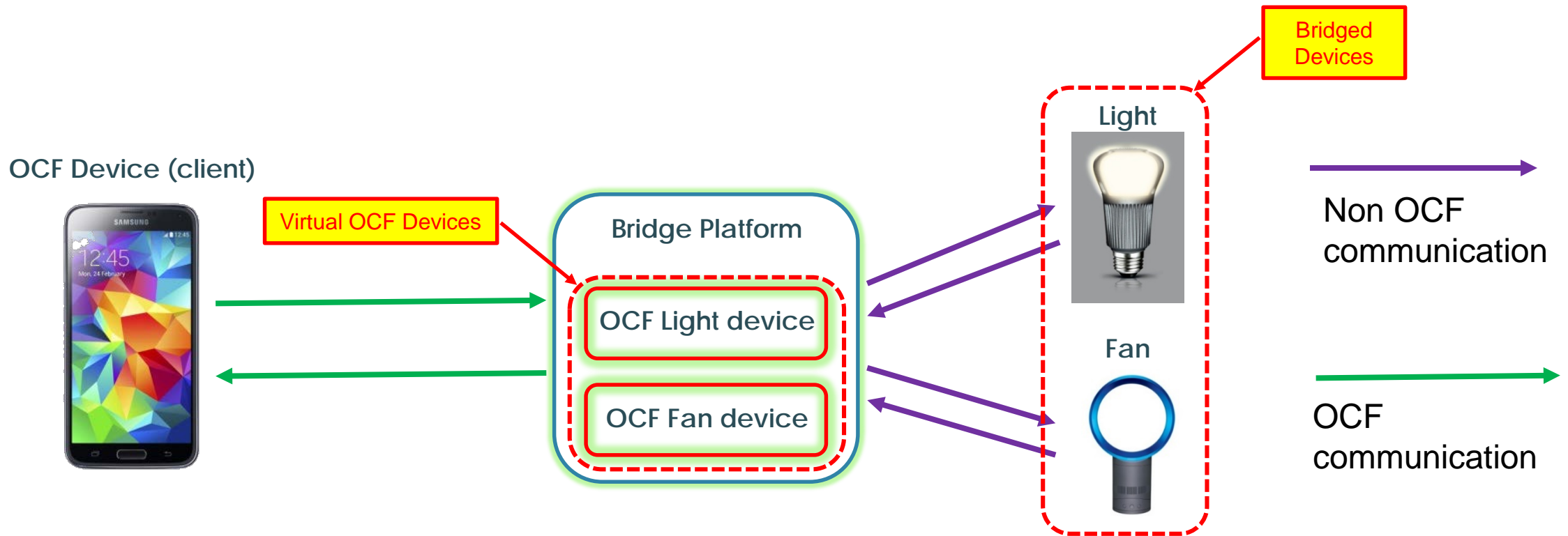



OCF Bridging Specification – Security

- The Bridge needs to be a trusted entity as it translates message payloads.
- The Bridge itself and all Virtual Devices that it exposes must be onboarded (transfer of ownership) and provisioned for secure operation.
- Each Virtual Device exposed by the Bridge must implement the security requirements of the ecosystem that it is connected to.
- Bridging specifies mechanisms to selectively block communications between the Bridge and OCF Devices and between the Bridge and Bridged Devices. This fine-grained control enables an administrator to control communications across ecosystems that may not have similar security capabilities.



OPEN CONNECTIVITY
FOUNDATION®

Data Models for Bridging

Derived Models





Data Model for Bridging - Derived Model

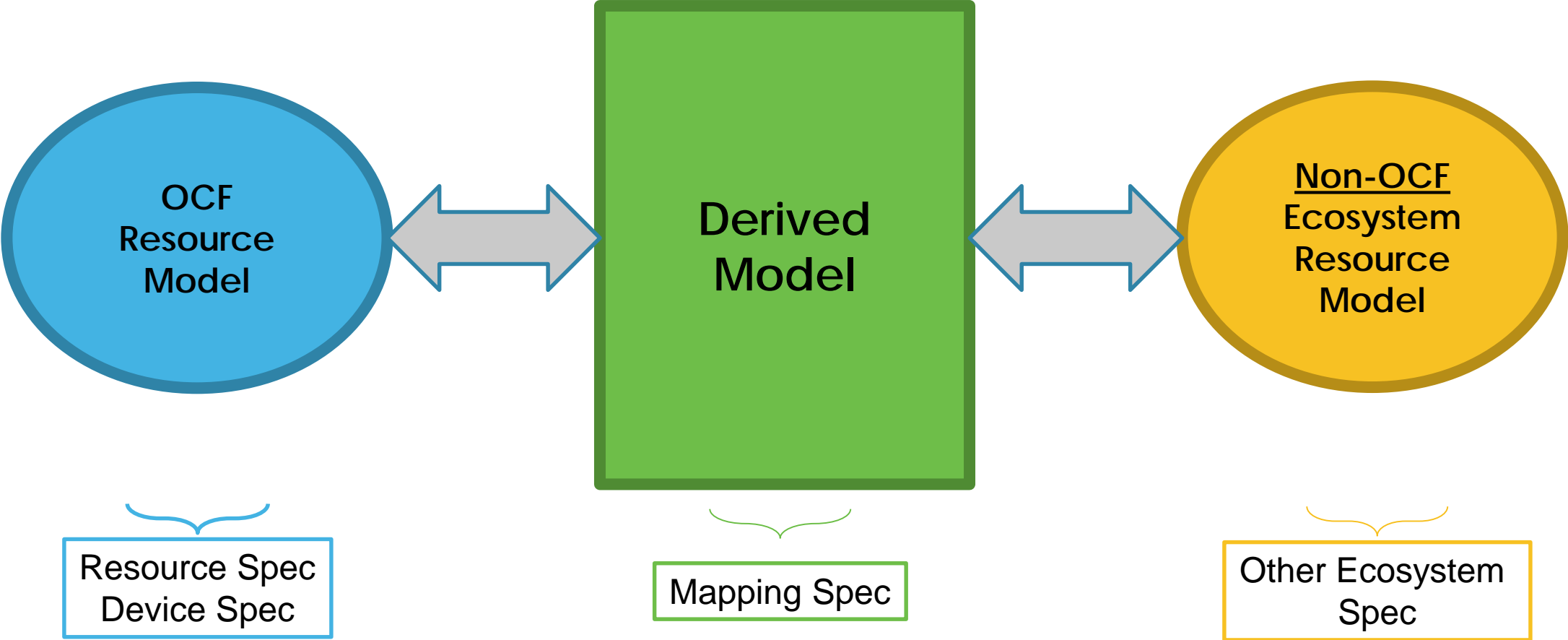



Derived Model Overview

- Models the interworking between OCF and the other ecosystem
- Makes use of derived model syntax as defined (with some small changes) in the OCF White Paper here: https://www.iab.org/wp-content/IAB-uploads/2016/03/OCF-Derived-Models-for-Interoperability-Between-IoT-Ecosystems_v2-examples.pdf
- Predicated on OCF being the superset model; so any Device Types and Resource Types (as equivalents to constructs in the other ecosystem) that were missing from OCF were defined in the equivalent OCF Specifications.
- Defines the mapping in terms of:
 - Device Type equivalency
 - Resource <-> other ecosystem equivalency
 - Detailed Property by Property mapping (Derived Models)



Derived Model Syntax

- Derived models use standard JSON schema syntax. Fundamentally, derived models provide a conversion mapping between OCF data models and the data models in the other ecosystem. The example below is for AllJoyn

```
"asa.environment.targethumidity": {
```

```
  "type": "object",
```

```
  "properties": {
```

```
    "targetvalue": {
```

```
      "type": "number",
```

```
      "description": "Measured value",
```

```
      "x-ocf-conversion": {
```

```
        "x-ocf-alias": "oic.r.humidity,oic.r.selectablelevels",
```

```
        "x-to-ocf": [
```

```
          "if minvalue != maxvalue, ocf.desiredhumidity = targetvalue:ocf.targetlevel = selectablehumiditylevels[0].",
```

```
          "if minvalue == maxvalue, ocf.targetlevel = targetvalue."
```

```
        ],
```

```
        "x-from-ocf": [
```

```
          "if x-ocf-alias == oic.r.humidity, targetvalue = desiredhumidity.",
```

```
          "if x-ocf-alias == oic.r.selectablelevels, targetvalue = targetlevel."
```

```
        ]
```

```
      }
```

```
    }
```

AllJoyn Interface Name

AllJoyn Property Name

OCF Equivalent Resource Type

To OCF from AllJoyn

From OCF to AllJoyn



OPEN CONNECTIVITY
FOUNDATION®

Ecosystem Bridges:

AllJoyn, oneM2M, ZigBee, BLE, Z-wave, U+



AllJoyn Device Type Equivalency

Classification	ASA Device Type	OCF Device Type	OCF Device Type ID
Air Care	Air Conditioner	Air Conditioner	oic.d.airconditioner
	AirPurifier	Air Purifier	oic.d.airpurifier
	AirQualityMonitor	Air Quality Monitor	oic.d.aqm
	Dehumidifier	Dehumidifier	oic.d.dehumidifier
	Humidifier	Humidifier	oic.d.humidifier
	ElectricFan	Fan	oic.d.fan
	Thermostat	Thermostat	oic.d.thermostat
Fabric Care	Clothes Washer	Washer	oic.d.washer
	Clothes Dryer	Dryer	oic.d.dryer
	Clothes Washer-Dryer	Washer-Dryer	oic.d.washerdryer
Food Preservation	Refrigerator	Refrigerator	oic.d.refrigerator
	Ice Maker	Ice Maker (Resource)	oic.r.icemaker
	Freezer	Freezer	oic.d.freezer
Food Preparation	Oven	Oven	oic.d.oven
	Cooktop	Cooktop	oic.d.cooktop
	Cookerhood	Cooker Hood	oic.d.cookerhood
	Foodprobe	Food Probe	oic.d.foodprobe
Dish Care	Dishwasher	Dishwasher	oic.d.dishwasher
Floor Care	Robot Cleaner	Robot Cleaner	oic.d.robotcleaner
Entertainment	TV	Television	oic.d.tv
	Set Top box (STB)	Set Top Box	oic.d.stb

- Yellow highlights identify Device Types that were added to support equivalency



AllJoyn Interface to Resource Mapping

AllJoyn Interface	OCF Resource Type Name	OCF Resource Type ID	OCF Interface(s)
Environment.CurrentAirQuality	Air Quality Collection	oic.r.airqualitycollection	oic.if.s
Environment.CurrentAirQualityLevel	Air Quality Collection	oic.r.airqualitycollection	oic.if.s
Environment.CurrentHumidity	Humidity	oic.r.humidity	oic.if.s
Environment.CurrentTemperature	Temperature	oic.r.temperature	oic.if.s
Environment.TargetHumidity	Humidity	oic.r.humidity, oic.r.selectablelevels	oic.if.a
Environment.TargetTemperature	Temperature	oic.r.temperature	oic.if.a
Operation.AudioVolume	Audio Controls	oic.r.audio	oic.if.a
Operation.Channel	Not mapped		
Operation.ClimateControlMode	Mode	oic.r.mode	oic.if.a
	Operational State	oic.r.operational.state	oic.if.s
Operation.ClosedStatus	Door	oic.r.door	oic.if.s
Operation.CycleControl	Operational State	oic.r.operational.state	oic.if.s
Operation.FanSpeedLevel	Air Flow	oic.r.airflow	oic.if.a
Operation.HeatingZone	Heating Zone Collection	oic.r.heatingzonecollection	oic.if.s
Operation.HvacFanMode	Mode	oic.r.mode	oic.if.a
Operation.OnOffStatus	Binary Switch	oic.r.switch.binary	oic.if.s
Operation.OvenCyclePhase	Operational State	oic.r.operationalstate	oic.if.s



OPEN CONNECTIVITY
FOUNDATION®

Ecosystem Bridges:

AllJoyn, oneM2M, ZigBee, BLE, Z-wave, U+



OCF to oneM2M Device Type Mapping

oneM2M Device Type	OCF Device Type
device3DPrinter	oic.d.3dprinter
deviceAirConditioner	oic.d.airconditioner
deviceAirPurifier	oic.d.airpurifier
deviceAirQualityMonitor	oic.d.airqualitymonitor
deviceAudioReceiver	oic.d.receiver
deviceBloodPressureMonitor	oic.d.bloodpressuremonitor
deviceCamera	oic.d.camera
deviceClothesDryer	oic.d.dryer
deviceClothesWasher	oic.d.washer
deviceCoffeeMachine	oic.d.coffeemachine
deviceCookerHood	oic.d.cookerhood
deviceCooktop	oic.d.cooktop
deviceDehumidifier	oic.d.dehumidifier
deviceDishWasher	oic.d.dishwasher
deviceDoor	oic.d.door
deviceDoorLock	oic.d.smartlock
deviceElectricVehicleCharger	oic.d.electricvehiclecharger
deviceFan	oic.d.fan
deviceFoodProbe	oic.d.foodprobe
deviceFreezer	oic.d.freezer
deviceGlucosemeter	oic.d.glucosemeter
deviceHumidifier	oic.d.humidifier
deviceKettle	oic.d.kettle
deviceLight	oic.d.light

oneM2M Device Type	OCF Device Type
deviceMicrogeneration	oic.d.energygenerator
deviceMultiFunctionPrinter	oic.d.multifunctionprinter
deviceOutdoorLamp	oic.d.light
deviceOven	oic.d.oven
devicePrinter	oic.d.printer
deviceRefrigerator	oic.d.refrigerator
deviceRobotCleaner	oic.d.robotcleaner
deviceScanner	oic.d.scanner
deviceSecurityPanel	oic.d.securitypanel
deviceSetTopBox	oic.d.stb
deviceSmartElectricMeter	oic.d.electricmeter
deviceSmartPlug	oic.d.smartplug
deviceSteamCloset	oic.d.steamcloset
deviceStorageBattery	oic.d.battery
deviceSwitch	oic.d.switch
deviceTelevision	oic.d.tv
deviceThermostat	oic.d.thermostat
deviceWaterHeater	oic.d.waterheater
deviceWaterValve	oic.d.watervalve
deviceWeightScaleAndBodyCompositionAnalyzer	oic.d.bodyscale
deviceWindowShade	oic.d.blind
deviceThermometer	oic.d.bodythermometer

- Yellow highlights identify Device Types that were added to support equivalency



OCF Resources to oneM2M Module Classes

oneM2M Module Class	OCF Resource Type
3Dprinter	oic.r.3dprinter
acousticsensor	oic.r.soundpressure
airconjobmode	oic.r.operational.state
airflow	oic.r.airflow
airpurifierjobmode	oic.r.operational.state
airqualitysensor	oic.r.airquality oic.r.switch.binary oic.r.humidity
alarmspeaker	oic.r.audiovolume oic.r.switch.binary oic.r.light.dimming
audioVolume	oic.r.audio
autodocumentfeeder	oic.r.operational.state
battery	oic.r.energy.battery
binaryswitch	oic.r.swtich.binary
boiler	oic.r.sensor
brewing	oic.r.brewing
brightness	oic.r.light.brightness
clock	oic.r.clock
clothesdryerjobmode	oic.r.operational.state
colour	oic.r.colour
coloursaturation	oic.r.colour.saturation
credentials	oic.r.userinfo
dehumidiiferjobmode	oic.r.operational.state
doorStatus	oic.r.door
electricvehicleconnector	oic.r.vehicle.connector
energyconsumption	oic.r.energy.electrical oic.r.energy.consumption
energygeneration	oic.r.energy.generation

oneM2M Module Class	OCF Resource Type
filterinfo	oic.r.consumable oic.r.sensor
foaming	oic.r.foaming
grinder	oic.r.grinder oic.r.switch.binary
heatingzone	oic.r.heatingzone
height	oic.r.height
hotwatersupply	oic.r.switch.binary oic.r.sensor
impactsensor	oic.r.impactsensor
keepwarm	oic.r.time.period
Keypad	oic.r.keypadchar
liquidlevel	oic.r.liquid.level
liquidremaining	oic.r.liquid.level
lock	oic.r.lock
motionSensor	oic.r.sensor.motion oic.r.sensor.props
openlevel	oic.r.openlevel
operationmode	oic.r.switch.binary
overcurrentsensor	oic.r.time.period oic.r.sensor
powersave	oic.r.switch.binary
printqueue	oic.r.printer.queue
pushbutton	oic.r.button
refrigeration	oic.r.refrigeration
relativeHumidity	oic.r.humidity
robotcleanerjobmode	oic.r.operational.state
steamclosetjobmode	oic.r.operational.state
temperature	oic.r.temperature
uvsensor	oic.r.sensor.radiation.uv
watersensor	oic.r.sensor.water
weight	oic.r.weight

- Yellow highlights identify Resource Types that were added to support equivalency



OPEN CONNECTIVITY
FOUNDATION®

Ecosystem Bridges:

AllJoyn, oneM2M, ZigBee, BLE, Z-wave, U+



OCF to Zigbee Device Type Mapping

Zigbee Device Type	Zigbee Device ID	OCF Device Type
On/off Output	0x0002	oic.d.smartplug
Mains Power Outlet	0x0009	oic.d.smartplug
Smart Plug	0x0051	oic.d.smartplug
On/Off Light	0x0100	oic.d.light
Dimmable Light	0x0101	oic.d.light
Color Dimmable Light	0x0102	oic.d.light
Color Temperature Light	0x010c	oic.d.light
Extended Color Light	0x010d	oic.d.light
Window Covering Device	0x0202	oic.d.blind
Thermostat	0x0301	oic.d.thermostat
Temperature Sensor	0x0302	oic.d.sensor
Occupancy Sensor	0x0107	oic.d.sensor
IAS Zone	0x0402	oic.d.sensor



OCF Resources to Zigbee Clusters

Zigbee Cluster	OCF Resource Type Name	OCF Resource Type ID	OCF Interface(s)
On/off	Binary Switch	oic.r.switch.binary	oic.if.a
Level Control	Dimming	oic.r.light.dimming	oic.if.a
Color Control	Colour Hue and Saturation, Colour Space Coordinates, Colour Temperature	oic.r.colour.hs, oic.r.colour.csc, oic.r.colour.colourtemperature,	oic.if.a
Thermostat	Temperature (3)	oic.r.temperature (3) * 1 for sensor, 2 for heater and cooler	oic.if.s oic.if.a
Window Covering	Window Covering	oic.r.windowcovering, oic.r.openlevel (4) * 2 for lift (percentage scale and cm scale), 2 for tilt (percentage scale and cm scale)	oic.if.rw oic.if.a
Temperature Measurement	Temperature	oic.r.temperature	oic.if.s
Occupancy Sensing	Presence Sensor	oic.r.sensor.presence	oic.if.s
IAS Zone	IAS Zone	oic.r.ias.zone	oic.if.rw

- Yellow highlights identify Resource Types that were added to support equivalency



OPEN CONNECTIVITY
FOUNDATION®

Ecosystem Bridges:

AllJoyn, oneM2M, ZigBee, BLE, Z-wave, U+



OCF to BLE Device Type Mapping

BLE GATT-based Profile	OCF Device Type
Blood Pressure Profile	"oic.d.bloodpressuremonitor"
Glucose Profile	"oic.d.glucosemeter"
Health Thermometer Profile	"oic.d.bodythermometer"
Weight Scale Profile	"oic.d.bodyscale"



OCF Resources to BLE Services

BLE GATT-based Profile	BLE Service	OCF Resource		OCF Device Type
		Atomic Measurement Resource Type	Resource Type	
Blood Pressure Profile	Blood Pressure Service	"oic.r. bloodpressuremonitor-am"	"oic.r.blood.pressure"	"oic.d.bloodpressuremonitor"
	Device Information Service		"oic.r.pulserate"	
			"oic.wk.d"	
			"oic.wk.p"	
Glucose Profile	Glucose Service	"oic.r.glucosemeter-am"	"oic.r.glucose"	"oic.d.glucosemeter"
			"oic.r.glucose.carb"	
			"oic.r.glucose.exercise"	
			"oic.r.glucose.hba1c"	
			"oic.r.glucose.health"	
			"oic.r.glucose.meal"	
			"oic.r.glucose.medication"	
			"oic.r.glucose.samplelocation"	
			"oic.r.glucose.tester"	
	Device Information Service		"oic.wk.d"	
		"oic.wk.p"		
Health Thermometer Profile	Health Thermometer Service	"oic.r.bodythermometer-am"	"oic.r.temperature"	"oic.d.bodythermometer"
	Device Information Service		"oic.r.body.location.temperature"	
			"oic.wk.d"	
			"oic.wk.p"	
Weight Scale Profile	Weight Scale Service	"oic.r.bodyscale-am"	"oic.r.weight"	"oic.d.bodyscale"
			"oic.r.bmi"	
			"oic.r.height"	
			"oic.r.body.fat"	
			"oic.r.body.water"	
			"oic.r.body.slm"	
			"oic.r.body.ffm"	
Device Information Service		"oic.wk.d"		
		"oic.wk.p"		



OPEN CONNECTIVITY
FOUNDATION®

Ecosystem Bridges:

AllJoyn, oneM2M, ZigBee, BLE, Z-wave, U+



OCF to Z-Wave Device Mapping

Z- Wave Plus Device	OCF Device Type	OCF Device Name
Light Dimmer Switch	oic.d.light	Light
Door Lock – Keypad	oic.d.smartlock	Smart Lock
On/Off Power Switch	oic.d.switch	Switch
Sensor - Multilevel	oic.d.sensor	Generic Sensor
Sensor – Notification	oic.d.sensor	Generic Sensor



OCF Resources to Z-Wave Command Class

Z- Wave Plus Device	Z-Wave Command Class	OCF Resource Type	OCF Device Type	OCF Device Name
Light Dimmer Switch	Multilevel Switch Command Class	oic.r.switch.binary	oic.d.light	Light
	Multilevel Switch Command Class	oic.r.light.dimming		
	Manufacturer Specific Command Class	oic.wk.d		
	Version Command Class	oic.wk.p		
	Z-Wave Plus Info Command Class			
Door Lock – Keypad	Door Lock Command Class	oic.r.lock.status	oic.d.smartlock	Smart Lock
	User Code Command Class	oic.r.lock.code		
	Battery Command Class	oic.r.energy.battery.		
	Manufacturer Specific Command Class	oic.wk.d		
	Version Command Class	oic.wk.p		
	Z-Wave Plus Info Command Class			
On/Off Power Switch	Binary Switch Command Class	oic.r.switch.binary	oic.d.switch	Switch
	Battery Command Class	oic.r.energy.battery.		
	Manufacturer Specific Command Class	oic.wk.d		
	Version Command Class	oic.wk.p		
	Z-Wave Plus Info Command Class			
Sensor - Multilevel	Multilevel Sensor Command Class	oic.r.sensor.carbondioxide	oic.d.sensor	Generic Sensor
	Multilevel Sensor Command Class	oic.r.sensor.carbonmonoxide		
	Multilevel Sensor Command Class	oic.r.sensor.water		
	Multilevel Sensor Command Class	oic.r.sensor.smoke		
	Battery Command Class	oic.r.energy.battery.		
	Manufacturer Specific Command Class	oic.wk.d		
	Version Command Class	oic.wk.p		
	Z-Wave Plus Info Command Class			
Sensor - Notification	Notification Command Class	oic.r.sensor.carbondioxide	oic.d.sensor	Generic Sensor
	Notification Command Class	oic.r.sensor.carbonmonoxide		
	Notification Command Class	oic.r.sensor.water		
	Notification Command Class	oic.r.sensor.smoke		
	Battery Command Class	oic.r.energy.battery.		
	Manufacturer Specific Command Class	oic.wk.d		
	Version Command Class	oic.wk.p		
	Z-Wave Plus Info Command Class			



OPEN CONNECTIVITY
FOUNDATION®

Ecosystem Bridges:

AllJoyn, oneM2M, ZigBee, BLE, Z-wave, U+



OCF to U+ Device Mapping

U+ Device	OCF Device Name	OCF Device Type ("rt")
Air Conditioner	Air Conditioner	"oic.d.airconditioner"
Water Heater	Water Heater	"oic.d.waterheater"
Air Purifier	Air Purifier	"oic.d.airpurifier"



OCF Resources to U+ Properties

U+ Device	U+ Property	OCF Resource Type	OCF Device Name	OCF Device Type ("rt")
Air Conditioner	"onOffStatus"	"oic.r.switch.binary"	Air Conditioner	"oic.d.airconditioner"
	"targetTemperature"	"oic.r.temperature"		
	"windSpeed"	"oic.r.selectablelevels"		
	"operationMode"	"oic.r.mode"		
Water Heater	"onOffStatus"	oic.r.switch.binary	Water Heater	"oic.d.waterheater"
	"targetTemperature"	"oic.r.temperature"		
Air Purifier	"onOffStatus"	"oic.r.switch.binary"	Air Purifier	"oic.d.airpurifier"
	"mode"	"oic.r.operational.state"		
	"windSpeed"	"oic.r.selectablelevels"		



OPEN CONNECTIVITY
FOUNDATION®

OCF Specification Overview Device and Resource Modeling

OCF 2.1.0 Release





OPEN CONNECTIVITY
FOUNDATION®

Resource Model: Resource Type Specification

Overview





Resource Specification

- List of reusable resources that are used in an OCF Device
 - More than 100 Resource Types are defined as of OCF 2.1.0; enabling Smart Home, Healthcare, and Smart Factory applications.
 - All Resource Types build on the Core definitions
- Each resource definition contains:
 - A unique identifier (rt)
 - Identification of the default interface and other supported interfaces
 - List of supported methods

*Resources are specified in OpenAPI2.0
(formerly known as 'Swagger 2.0')*

See <https://oneiota.org> for the complete set of OCF defined Resource Types



Resource Type Map

- All OCF Resource Types are available in: <https://oneiota.org>
- A list of all currently accepted Resource Types with links to the OpenAPI definitions that are found in oneIoTa may be found here: <https://openconnectivityfoundation.github.io/devicemodels/docs/resource.html>
- All OCF Resource Type IDs are IANA registered: <http://www.iana.org/assignments/core-parameters/core-parameters.xhtml>

If an OCF Device hosts an OCF defined resource then it shall follow all normative requirements in the Resource Specification applicable to that Resource.



Newly Defined Resource Types – OCF 2.1.0

Resource Type	Use Case Category	Use Case Detail
Deodorization	Smart Devices	Modeling for Air Purifiers, Room Air Conditions, Refrigerators etc.
Key Card Switch	Home Security	Equivalency for EnOcean, detection of presence or otherwise of a keycard in a reader
Muscle Oxygen Saturation	Personal Health	Percentage of hemoglobin that is saturated with oxygen (aka. SmO2).



OPEN CONNECTIVITY
FOUNDATION®

Device Specification

Overview





Higher Layer Specifications

- Specifications are split into 2 documents:
 - Device specification (per vertical Annexes if needed)
 - Resource specification (vertical agnostic)

The Device specification uses the Resources defined in the Resource Specification



Device Specification

- Contains profiles of
 - Core specification
 - Security specification
- Contains list of OCF devices
- Each OCF device definition contains:
 - Human friendly name
 - Unique identifier (rt) in the form `oic.d.<thing>`
 - This is exposed in an OCF Device as part of

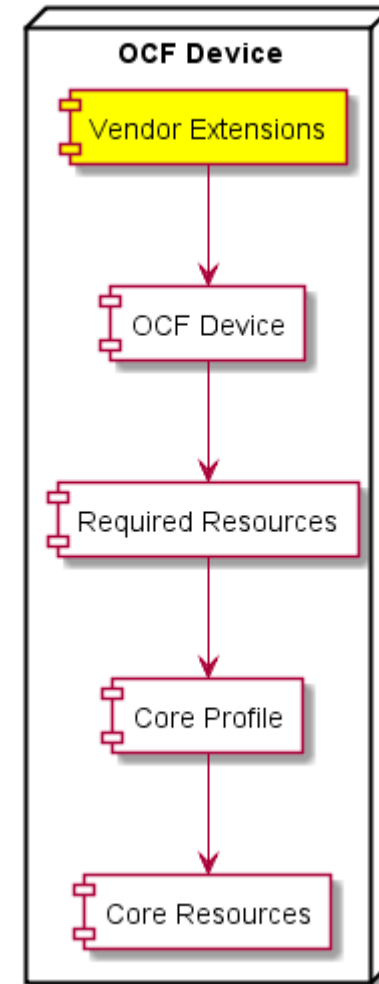

Exposure of an OCF Device Type is Mandatory. If an OCF Server hosts an OCF known device then it shall follow all normative requirements in the Device Specification applicable to that Device.



Device Categories

- All OCF devices are grouped into Device Categories based on the Universal Device Classification (UDC) that was developed by LBNL.
- <https://eta-intranet.lbl.gov/sites/default/files/lbnl-classification-v1.pdf>

Device Category Name	Description
LBNL Categories	
Space Conditioning	Heating and cooling systems
Lighting	
Appliance	Also known as “white goods”; covers major appliances only.
Electronics	Personal electronics
Miscellaneous	Small appliances, other
Infrastructure	Physical building and infrastructure
Transportation	Vehicles, fixed devices that provide movement (e.g. Escalators)
Other	
OCF Added Categories	
Fitness	Includes lifestyle
Medical	
Personal Health	



Mandatory Resources per Device Type

- A vertical may specify a set of Resources that are mandatory to expose by a specific Device Type.
 - Note: a Device is free to expose any number of optional Resources that it requires
 - Currently defined verticals: Smart Home, Healthcare, Industrial, Photo Voltaic System
- The complete set of Device Types and any associated mandatory resources that exist for a vertical are all available in github:
 - <https://github.com/openconnectivityfoundation/devicemodels/blob/master/oic.devicemap-content.json>



Vendor Extensions

- A vendor is allowed to:
 - Create their own defined (non-OCF standardized) Resource Types
 - Create their own defined (non-OCF standardized) Device Types
 - Extend existing devices with additional (not mandated) Resource Types
 - With standardized resource types
 - With vendor defined resource types
- All vendor extensions follow an OCF defined naming scheme



Some Example Device Types

Category	Name	Device Type	Mandatory Resources
Appliance	Refrigerator	oic.d.refrigerator	Temperature (x2)
Electronics	3D Printer	oic.d.3dprinter	Binary Switch, 3D Printer, Temperature, Printer Queue, Operational State
Miscellaneous	Optical Augmented RFID Reader	oic.d.orfid	RFID Tag, RFID Station
Personal Health	Body Scale	oic.d.bodyscale	Body Scale Atomic Measurement

Note: All defined Device Types are of the form "oic.d.<thing>" where <thing> is a single alphanumeric string (lower case [a..z],[0..9] only) no more than 24 characters in length giving a total maximum length of the Device Type of 32 characters



Device example: light device (oic.d.light)

- Example overview
 - Smart light device exposing a binary switch (mandatory) and a brightness (optional) Resource
- Device type: Light (oic.d.light)
- Associated resources
 - Mandatory Core resources: /oic/res, /oic/p, /oic/d, Introspection
 - Mandatory Security Resources (not shown in the diagram)
 - Mandatory Resources for the Device Type: Binary switch (oic.r.switch.binary),
 - Other optional resources can be exposed, in this example Brightness resource (oic.r.light.brightness)

Device Name	Device Type	Resource Type	M/O
Light	oic.d.light	oic/res (oic.wk.res)	M
		oic/p (oic.wk.p)	M
		oic/d (oic.d.light)	M
		Introspection (oic.wk.introspection)	M
		Binary switch (oic.r.switch.binary)	M
		Brightness (oic.r.light.brightness)	O

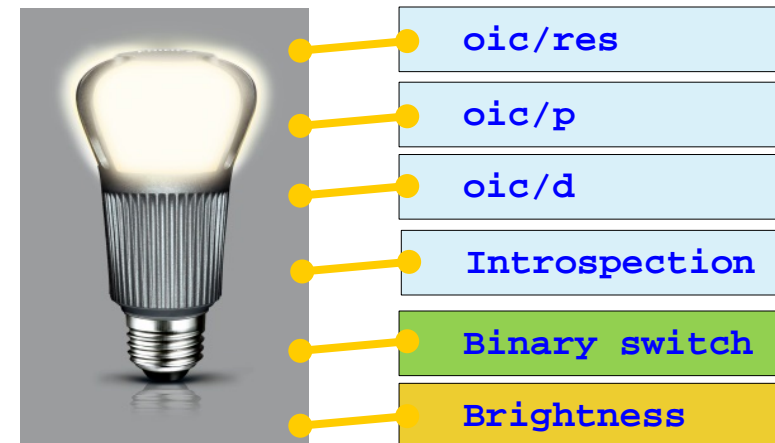



Complete Set of OCF Defined Device Types (1/2)

Friendly Name	Device Type
3D Printer	oic.d.3dprinter
Activity Tracker	oic.d.activitytracker
Air Conditioner	oic.d.airconditioner
Air Purifier	oic.d.airpurifier
Air Quality Monitor	oic.d.airqualitymonitor
Battery	oic.d.battery
Blind	oic.d.blind
Blood Pressure Monitor	oic.d.bloodpressuremonitor
Body Scale	oic.d.bodyscale
Body Thermometer	oic.d.bodythermometer
Camera	oic.d.camera
Circuit Breaker	oic.d.circuitbreaker
Clothes Dryer	oic.d.dryer

Friendly Name	Device Type
Clothes Washer	oic.d.washer
Clothes Washer/Dryer	oic.d.washerdryer
Coffee Machine	oic.d.coffeemachine
Continuous Glucose Meter	oic.d.cgm
Cooker Hood	oic.d.cookerhood
Cooktop	oic.d.cooktop
Cycling Cadence Sensor	oic.d.cyclingcadencesensor
Cycling Power Meter	oic.d.cyclingpowermeter
Cycling Speed Sensor	oic.d.cyclingspeedsensor
Dehumidifier	oic.d.dehumidifier
Dishwasher	oic.d.dishwasher
Door	oic.d.door
Electric Meter	oic.d.electricmeter
Electric Vehicle Charger	oic.d.electricvehiclecharger

Items in red are new in OCF 2.1.x



Complete Set of OCF Defined Device Types (2/2)

Friendly Name	Device Type
Energy Generator	oic.d.energygenerator
Energy Monitor	oic.d.energymonitor
Fan	oic.d.fan
Food Probe	oic.d.foodprobe
Freezer	oic.d.freezer
Garage Door	oic.d.garagedoor
Generic Sensor	oic.d.sensor
Glucose Meter	oic.d.glucosemeter
Grinder	oic.d.grinder
Heart Rate Monitor	oic.d.heartratemonitor
Humidifier	oic.d.humidifier
Humidifier	oic.d.humidifier
Inverter	oic.d.inverter

Friendly Name	Device Type
Kettle	oic.d.kettle
Light	oic.d.light
Microwave Oven	oic.d.microwave
Muscle Oxygen Monitor	oic.d.muscleoxygenmonitor
Optical Augmented RFID Reader	oic.d.orfid
Oven	oic.d.oven
PV Array System	oic.d.pvarraysystem
Printer	oic.d.printer
Printer (Multi-Function)	oic.d.multifunctionprinter
Pulse Oximeter	oic.d.pulseoximeter
Receiver	oic.d.receiver
Refrigerator	oic.d.refrigerator

Friendly Name	Device Type
Robot Cleaner	oic.d.robotcleaner
Scanner	oic.d.scanner
Security Panel	oic.d.securitypanel
Set Top Box	oic.d.stb
Sleep Monitor	oic.d.sleepmonitor
Smart Lock	oic.d.lock
Smart Plug	oic.d.smartplug
Speaker	oic.d.speaker
Steam Closet	oic.d.steamcloset
Switch	oic.d.switch
Television	oic.d.tv
Thermostat	oic.d.thermostat
Water Heater	oic.d.waterheater
Water Purifier	oic.d.waterpurifier
Water Valve	oic.d.watervalve
Window	oic.d.window



OPEN CONNECTIVITY
FOUNDATION®

References





Specification Location

Where can I find the specifications and Resource Type definitions?

OCF Specifications:

- <https://openconnectivity.org/developer/specifications>

Resource Type Definitions

- Core Resources: <https://github.com/openconnectivityfoundation/core>
- Core Optional Resources and Extensions: <https://github.com/openconnectivityfoundation/core-extensions>
- Bridging Resources: <https://github.com/openconnectivityfoundation/bridging>
- Cloud Resources: <https://github.com/openconnectivityfoundation/cloud-services>
- Security Resources: <https://github.com/openconnectivityfoundation/security>
- Vertical Resources and Derived Models: https://oneiota.org/documents?filter%5Bmedia_type%5D=application%2Fswagger%2Bjson



Device and Resource Maps

A web front end to the github hosted device and resource maps that are maintained by OCF may be found here:

- <https://openconnectivityfoundation.github.io/devicemodels/docs/index.html>

OneIoTa Tool



The screenshot displays the OneIoTa web interface. At the top, there is a search bar labeled "Search All Models" and a "Sign In" button. Below the search bar, the interface shows a list of models with columns for Filename, Type, Date, Organization, Release, Proposals, and Versions. The list includes models like "acceleration.raml", "activityCount.raml", and "airFlowControl.raml".

The detailed view shows the JSON Schema for "oic.r.autofocus.json". The schema is as follows:

```
1 {
2   "id": "http://openinterconnect.org/iotdatamodels/schemas/oic.r.autofocus.json",
3   "schemas": "http://json-schema.org/draft-04/schema#",
4   "description": "Copyright (c) 2016, 2017 Open Connectivity Foundation, Inc. All rights reserved.",
5   "title": "Auto Focus",
6   "definitions": {
7     "oic.r.autofocus": {
8       "type": "object",
9       "properties": {
10        "autofocus": {
11          "type": "boolean",
12          "description": "Status of the Auto Focus"
13        }
14      }
15    },
16    "type": "object",
17    "allOf": [
18      { "$ref": "oic.baseResource.json#/definitions/oic.r.baseResource" },
19      { "$ref": "#/definitions/oic.r.autofocus" }
20    ],
21    "required": [ "autofocus" ]
22  }
23 }
24 }
```

- Web based (see: <http://oneiota.org>) development tool
- Supports RAML, JSON, and OpenAPI2.0 syntax
- Populated to date with all OCF Resources (in OpenAPI2.0), plus OCF-AllJoyn, OCF-BLE, OCF-oneM2M, OCF-Uplus, OCF-Zigbee, and OCF-ZWave derived models.
- Supports multiple organizations
 - Each submitting organization defines their own license terms



OPEN CONNECTIVITY
FOUNDATION®