



NIST
PUBLICATIONS



NIST SPECIAL PUBLICATION 260-141

U.S. DEPARTMENT OF COMMERCE/Technology Administration
National Institute of Standards and Technology

Standard Reference Materials: **Secondary Ferrite Number Reference Materials Gage Calibration and Assignment of Values**

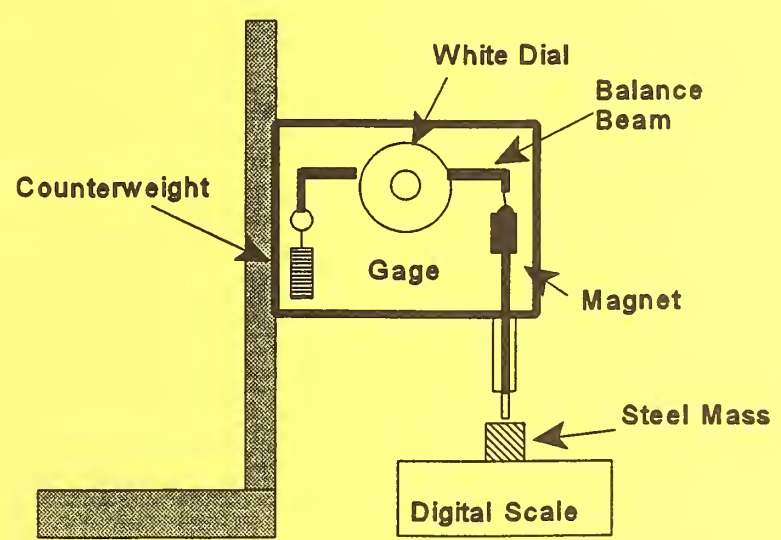

C. N. McCowan, T. A. Siewert,
D. P. Vigliotti, and C. M. Wang

QC
100
.U57
NO.260-141
2000

The National Institute of Standards and Technology was established in 1988 by Congress to “assist industry in the development of technology . . . needed to improve product quality, to modernize manufacturing processes, to ensure product reliability . . . and to facilitate rapid commercialization . . . of products based on new scientific discoveries.”

NIST, originally founded as the National Bureau of Standards in 1901, works to strengthen U.S. industry’s competitiveness; advance science and engineering; and improve public health, safety, and the environment. One of the agency’s basic functions is to develop, maintain, and retain custody of the national standards of measurement, and provide the means and methods for comparing standards used in science, engineering, manufacturing, commerce, industry, and education with the standards adopted or recognized by the Federal Government.

As an agency of the U.S. Commerce Department’s Technology Administration, NIST conducts basic and applied research in the physical sciences and engineering, and develops measurement techniques, test methods, standards, and related services. The Institute does generic and precompetitive work on new and advanced technologies. NIST’s research facilities are located at Gaithersburg, MD 20899, and at Boulder, CO 80303. Major technical operating units and their principal activities are listed below. For more information contact the Publications and Program Inquiries Desk, 301-975-3058.

Office of the Director

- National Quality Program
- International and Academic Affairs

Technology Services

- Standards Services
- Technology Partnerships
- Measurement Services
- Technology Innovation
- Information Services

Advanced Technology Program

- Economic Assessment
- Information Technology and Applications
- Chemical and Biomedical Technology
- Materials and Manufacturing Technology
- Electronics and Photonics Technology

Manufacturing Extension Partnership Program

- Regional Programs
- National Programs
- Program Development

Electronics and Electrical Engineering Laboratory

- Microelectronics
- Law Enforcement Standards
- Electricity
- Semiconductor Electronics
- Electromagnetic Fields¹
- Electromagnetic Technology¹
- Optoelectronics¹

Chemical Science and Technology Laboratory

- Biotechnology
- Physical and Chemical Properties²
- Analytical Chemistry
- Process Measurements
- Surface and Microanalysis Science

Physics Laboratory

- Electron and Optical Physics
- Atomic Physics
- Optical Technology
- Ionizing Radiation
- Time and Frequency¹
- Quantum Physics¹

Materials Science and Engineering Laboratory

- Intelligent Processing of Materials
- Ceramics
- Materials Reliability¹
- Polymers
- Metallurgy
- NIST Center for Neutron Research

Manufacturing Engineering Laboratory

- Precision Engineering
- Automated Production Technology
- Intelligent Systems
- Fabrication Technology
- Manufacturing Systems Integration

Building and Fire Research Laboratory

- Structures
- Building Materials
- Building Environment
- Fire Safety Engineering
- Fire Science

Information Technology Laboratory

- Mathematical and Computational Sciences²
- Advanced Network Technologies
- Computer Security
- Information Access and User Interfaces
- High Performance Systems and Services
- Distributed Computing and Information Services
- Software Diagnostics and Conformance Testing
- Statistical Engineering

¹At Boulder, CO 80303.

²Some elements at Boulder, CO.

NIST Special Publication 260-141

Standard Reference Materials:

Secondary Ferrite Number Reference Materials Gage Calibration and Assignment of Values

C. N. McCowan, T. A. Siewert,
D. P. Vigliotti, and C. M. Wang

Materials Reliability Division
Materials Science and Engineering Laboratory
National Institute of Standards and Technology
325 Broadway
Boulder, Colorado 80303-3328



U.S. DEPARTMENT OF COMMERCE, William M. Daley, Secretary
TECHNOLOGY ADMINISTRATION, Dr. Cheryl L. Shavers, Under Secretary of Commerce for Technology
NATIONAL INSTITUTE OF STANDARDS AND TECHNOLOGY, Raymond G. Kammer, Director

Issued February 2000

National Institute of Standards and Technology Special Publication 260-141
Natl. Inst. Stand. Technol. Spec. Publ. 260-141, 87 pages (Feb. 2000)
CODEN: NSPUE2

U.S. GOVERNMENT PRINTING OFFICE
WASHINGTON: 2000

Contents

1. Introduction	2
2. Secondary Specimens	2
3. Gage Calibration	3
3.1 Frequency	3
3.2 Determination of Tearing Force	4
3.3 Primary FN Calibration	5
3.4 Calibration Errors and Variables	12
3.5 Force Calibration	16
3.6 Summary of Primary Calibrations	18
4. Measurement of Secondary Reference Materials	21
4.1 Measurement Procedure	21
4.2 Data Analysis	21
4.3 Data Trends	22
5. Certification of Secondary Reference Materials and Discussion of Errors	27
5.1 Uncertainty Analysis	27
6. Microstructure	30
6.1 Grain Size	35
6.2 Ferrite Content	35
6.3 X-ray Evaluation	36
6.4 Solidification Flaws	37
6.5 Atomic Force Microscopy	38
7. Information on the Reference Material	39
8. Plans	39
9. References	39
Appendix A. Primary Calibration Data	40
Appendix B. Summary Data for the Secondary Reference Materials	43
Appendix C. Raw Data for the Secondary Reference Materials	51
Appendix D. Round-Robin Data for Primary FN Standards	79

Secondary Ferrite Number Reference Materials: Gage Calibration and Assignment of Values

C.N. McCowan, T.A. Siewert, D.P. Vigliotti, and C.M. Wang
Materials Reliability Division, Materials Science and Engineering Laboratory
National Institute of Standards and Technology
Boulder, CO 80303-3328

Ferrite Numbers (FN) were assigned to blocks of stainless steel that serve as secondary ferrite reference materials (RM 8480 and 8481) and these specimens were placed in our Reference Materials inventory.* These reference materials are used to calibrate several types of instruments used to measure the FN, which is proportional to the ferrite content in stainless steel welds. The ferrite content influences the physical and mechanical properties of stainless steel welds. This report documents the procedures used to measure the reference materials and the results of our measurements. Appendices are included to document our primary gage calibrations (Appendix A), the measurements made on the FN reference materials (Appendices B and C), and other supporting measurements made for the study (Appendix D).

Our initial effort was devoted to finding and reducing sources of uncertainty in the gages (instruments for measuring FN) and in the calibration procedures. After improving our gages and procedures, we found that our calibration lines were nearly linear over the range of 0 to 100 FN and that the gages compare well to gages used by The Welding Institute (TWI), which had assigned the certified FN values to secondary specimens produced in the past.

The measurements on the reference materials showed that the standard deviations in FN for the secondary specimens were typically less than 0.5 FN for the 0 to 30 FN range, and less than 3 FN for the 30 to 100 FN range. The microstructure was found to be a finely dispersed and homogeneous mixture of ferritic and austenitic phases, with a percent ferrite area fraction that was nearly equivalent to the FN assigned to the reference materials (up to about 60 FN).

Key words: inspector gage, ferrite, feriscope, ferrite content, ferrite detector, ferrite number, Magne-Gage, reference material, stainless steel.

*Trade names are included for clarity only; no endorsement or criticism is implied.

1. Introduction

Austenitic weld metals usually contain a small but controlled amount of ferrite to reduce the tendency for cracking during solidification. Duplex ferritic-austenitic stainless steel welds contain a balance of austenitic and ferritic phases to optimize their mechanical properties. Quantitative measurement of the ferrite content is an important commercial issue, as ranges are commonly specified in contracts and production standards. In the U.S., the amount of ferrite is usually measured magnetically according to the American Welding Society AWS A4.2 standard, *Standard Procedures for Calibrating Magnetic Instruments to Measure the Delta Ferrite Content of Austenitic and Duplex Austenitic-Ferritic Stainless Steel Weld Metal* [1].

The AWS A4.2 standard specifies procedures for both primary and secondary calibration of the instruments. Primary calibration is based on reference materials of coating thickness, such as the National Institute of Standards and Technology Standard Reference Materials (SRMs) 1361 to 1364, while secondary calibration is based on certified specimens of stainless steel. In section 3.2, the standard describes the importance of secondary reference materials as: the only way of calibrating instruments for which no primary calibration method exists, the most appropriate standard for in-process checks, and being much more durable than the primary reference materials.

At least three different companies or organizations have produced specimens, assigned values, and sold sets of secondary reference materials during the past 30 years [2]. One of our goals during development of our internal procedures was to assure ourselves that our calibration scale was comparable to those used previously. Also, we worked closely with Commission II of the International Institute of Welding and with the Welding Research Council's Subcommittee on Welding of Stainless Steel, to assure that our procedures would maintain, if not raise, the accuracy of the measurements.

2. Secondary Specimens

The specimens were produced in Russia from centrifugal castings of chromium-nickel-iron alloys. The ferrite content (magnetic phase) is varied by adjusting the composition of the alloy. The cast specimens approximate the ferrite distribution in a weld deposit and have solidification structures similar to those in welds. Like ferrite in welds, the magnetic response of the ferritic phase varies with alloy composition (Cr, Ni, Mo).

The dimensions of the specimen are approximately 10 mm × 12 mm × 20 mm, as shown in Figure 1. The secondary specimens are sold in sets: (a) a lower-range set with eight specimens distributed over the range of 0 to 30 FN, and (b) a higher-range set of eight specimens distributed over the range of 30 to 120 FN. The specimens are marked by engraving identification numbers on the 12 mm × 20 mm face opposite the measurement surface.

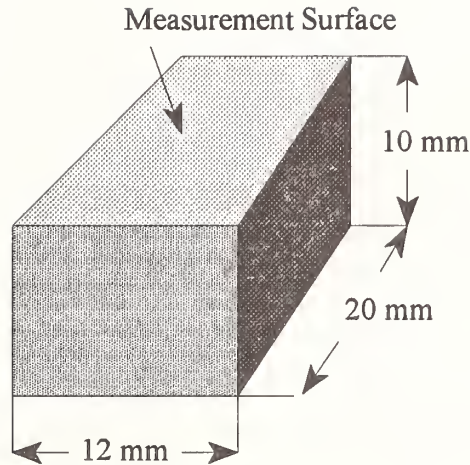

Figure 1. FN secondary specimen configuration.

The ferrite content is measured in terms of an arbitrary quantity, the Ferrite Number (FN). The FN of the specimen is determined using a gage that measures the force required to pull a magnet of known strength off the surface of the specimen. We used a transfer-standard technique to assign numbers to the new reference materials. We first calibrated gages (as described in the following sections), then used them to assign FN values to the secondary reference specimens.

The FN is expected to be approximately equal to the percent ferrite in stainless steel welds up to about 15, but at higher than 15 FN the true percent of ferrite in welds is overestimated by the FN numbers. (These concepts are described in more detail in AWS A4.2.)

3. Gage Calibration

The gage used to assign FNs to the secondary specimens is shown schematically in Figure 2. It is essentially a balance, referred to as a Magne-Gage-type instrument in AWS A4.2. The white dial winds a spring as it is turned and this applies a gradually increasing force to lift the magnet off the surface of the specimen. Counterweights can be hung on one side of the balance to increase the applied force. To calibrate this type of gage, a primary coating-thickness standard is used to determine a relationship between FN (calculated for each coating thickness) and white-dial values for the gage. We use the average FN of two gages to assign certified values to the reference materials in our program. The calibration data are given in Appendix A.

3.1 Frequency

The calibration for a gage is valid for a maximum period of one year, as specified by AWS A4.2. When making measurements to assign values to secondary reference materials, we checked the gage calibration at the beginning of each day. The check was made by measuring three primary

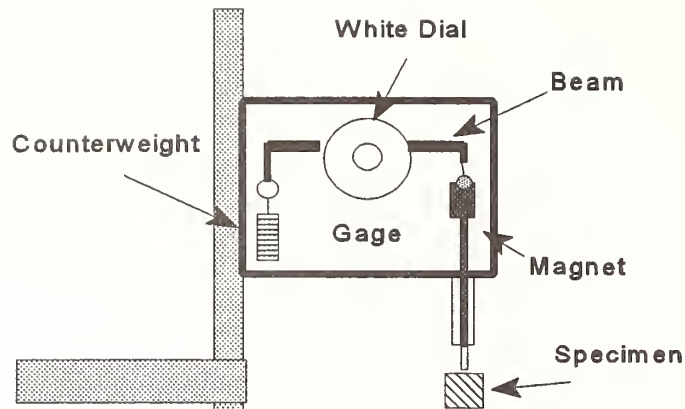

Figure 2. Schematic diagram showing the general features of the gage.

reference materials in the range of interest and comparing these results to those recorded for the same primary reference materials during the initial calibration. If this check indicated that a recalibration of the gage (or maintenance) was needed, the full calibration procedure was implemented.

3.2 Determination of Tearing Force

The magnet used for FN measurement is required by AWS A4.2 to have a tearing force of 510 ± 51 FN per newton (5 ± 0.5 FN per gram-force). Using a magnet that is too weak will result in falsely high FN values, and using a magnet that is too strong will result in falsely low FN values (with respect to the standardized method).

Traditionally, the magnet's strength is measured on Magne-Gage-type instruments by suspending a five-gram iron weight from the magnet. The dial reading at the time the weight is lifted just past the balance point of the gage is divided by the weight to yield the tearing force. Using this procedure, tearing forces of 490 and 541 FN per newton (4.8 and 5.3 FN per gram-force) were determined for gages 1 and 2.

The magnet's strength can be determined directly from the slope of the calibration line if a torsion balance is used, or a Magne-Gage-type instrument is used that has been calibrated in terms of force. We calibrated our gages using a digital scale to determine the force associated with the white-dial readings. To do this, a steel mass was positioned below the magnet, as shown in Figure 3. As the white dial on the gage was turned to load the spring on the gage, the force on the mass was recorded. The steel mass was sufficiently large that it would not be lifted off the scale over the range of measurement. Once the white-dial was correlated to force (linear regression), the force was substituted for the white-dial data and correlated to FN (see section 3.5). The slopes of the FN/Force regression lines for gages 1 and 2 were found to be 541 and 561

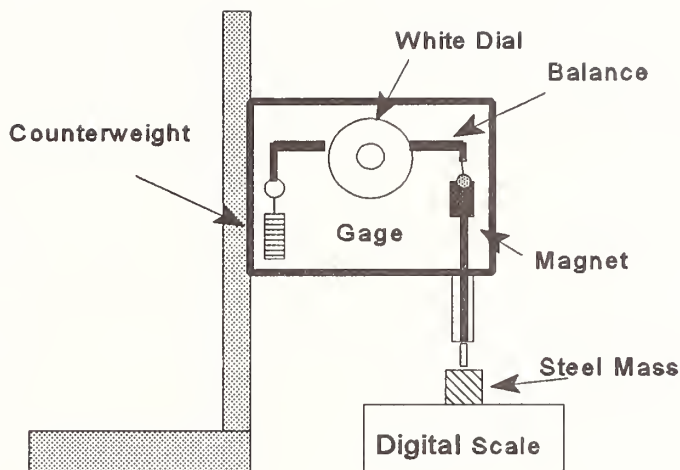

Figure 3. Schematic of the set-up used for force calibration measurements.

FN per newton (5.3 and 5.5 FN per gram-force), respectively. The procedures yield different results, but all values are within the 510 ± 51 FN per newton (5 ± 0.5 FN per gram-force) required by AWS A4.2.

3.3 Primary FN Calibration

Primary reference materials for coating-thickness were used to calibrate the gages. The FN of the reference materials were calculated using an equation from AWS A4.2:

$$\ln(\text{FN}) = 1.8059 - 1.1189 \cdot \ln(T) - 0.1774 \cdot [\ln(T)]^2 - 0.0350 \cdot [\ln(T)]^3 - 0.0037 \cdot [\ln(T)]^4, \quad (1)$$

where T is the thickness of the coating in millimeters.

The specific reference materials used to calibrate the gages are given in Table 1. The coating thicknesses are distributed through the range of 0.01 to 1.9 mm, which corresponds to a range of 0 to 130 FN (from eq (1)). To calibrate a gage, each reference material listed in Table 1 was measured a minimum of five times and the lowest repeatable white-dial readings from these measurements were taken as the calibration value. (The lowest value is taken, as recommended in AWS A4.2, to screen out values associated with premature detachments of the magnet.) Two operators independently calibrated each gage, and the average of the two white-dial values serves as the final calibration value for each standard. The calibration data for the gages used in this study are given in Appendix I.

An example of a typical calibration plot is shown in Figure 4 for the gage 2 data. The 0 to 30 FN data and two sets of extended FN data are plotted as separate lines (0, 7, and 14 g

counterweights). Typically, three or more calibration lines would be needed to cover the range of 0 to 100 FN. According to AWS A4.2, two lines can be fitted to the data in the 0 to 30 FN range, and above 30 FN, separate lines are fitted to data for each counterweight.

AWS A4.2 requires that the slopes of the various calibration lines be similar, and specifies the maximum variations allowed between the fitted lines and the FN assigned to the primary reference materials. The allowed variations are as follows:

± 0.40	0 to 5 FN,
± 0.50	5 to 10 FN,
± 0.70	10 to 15 FN,
± 0.90	15 to 20 FN,
± 1.00	20 to 30 FN,
± 5%	30 to 90 FN.

The requirement that the slopes of the various calibration lines be similar helps ensure that the estimates of FN calculated from the calibration lines are more or less continuous over the 0 to 100 FN range. If the slopes are very similar and the intercepts are correct, this approach serves as an accurate calibration procedure. It is awkward, however to justify why sets of discontinuous data are used to develop independent equations for the calculation of FN, particularly when Hooke's law says the slopes should be the same. For this reason, we took a slightly different approach and used offsets to produce a white-dial calibration that was continuous over the range of 0 to 100 FN.

The offsets can be determined in several ways. One way is to measure a primary standard using two counterweights. For example, measuring SRM 1313 (Table 1) on gage 1 produced a white dial value of 45.75 with no counterweight, and a white-dial value of 150.75 with a 7 g counterweight. The offset for gage 1, 105, is the difference between the two values. The offset for gage 2 was determined to be 118. Another way to find the offset is to use a digital scale to determine the white-dial reading that corresponds to equal forces for various counterweight configurations. This approach was used to construct the continuous data sets for gages 1 and 2 that are shown in Figures 5 and 6.

Table 1: Primary coating-thickness reference materials (mm).

Identification	Thickness	FN
SRM 1364a-93.082	1.901	2.729
SRM 1364	1.800	2.943
SRM 1364	1.700	3.180
SRM 1364a-93.082	1.631	3.360
SRM 1364	1.070	5.637
SRM 1364a-93.082	1.006	6.045
SRM 1364a-93.082	0.820	7.548
SRM 1364	0.810	7.646
SRM 1363a-93.293	0.615	10.092
SRM 1363a-93.293	0.496	12.359
SRM 1313	0.371	15.982
SRM 1313	0.277	20.369
SRM 1363a-93.293	0.251	22.035
NBS-CD # 154107	0.208	25.544
SRM 1312	0.195	26.780
NBS-CC # 154107	0.137	34.671
NBS-CB # 154107	0.084	48.730
SRM 1321	0.048	69.054
NBS 7656 AD	0.048	69.357
SRM 1321	0.044	73.297
1984-CA # 154107	0.038	79.742
SRM 1321	0.037	79.971
SRM 1321	0.035	83.674
NBS 7656 AD	0.028	94.184
NBS 7656 AD	0.014	130.250

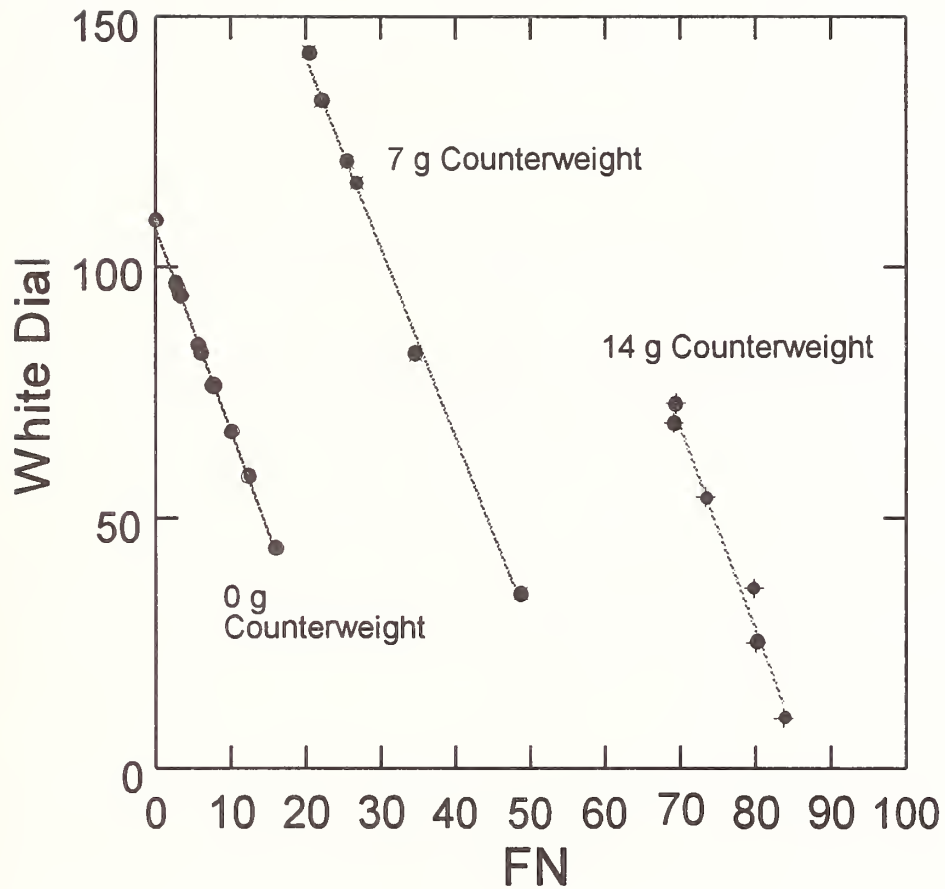

Figure 4. Calibration data for gage 2. The three sets of data show the typical appearance for calibration lines over the range of 0 to 100 FN. Calibration lines are determined separately for the 0, 7, and 14 g counterweights, respectively.

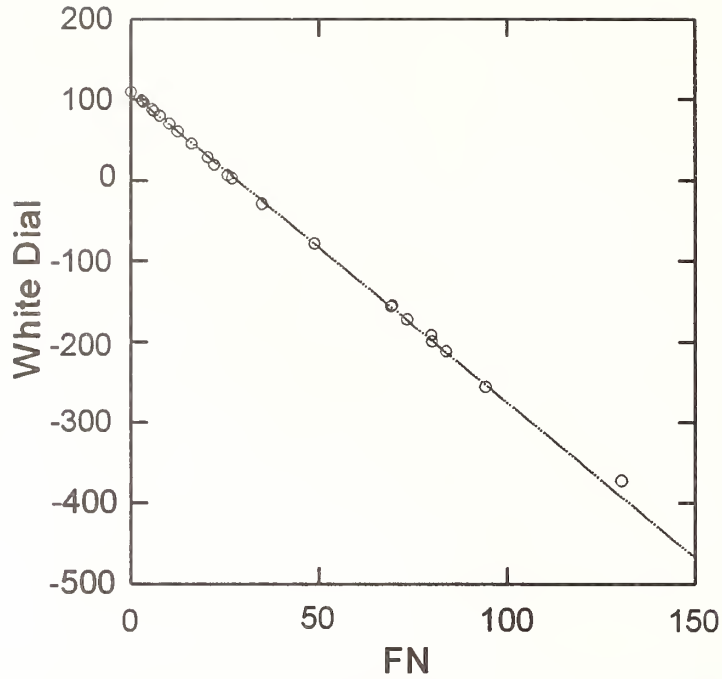

Figure 5. Calibration data for gage 1 using offset white-dial values to allow a continuous linear fit of data over the 0 to 100 FN range.

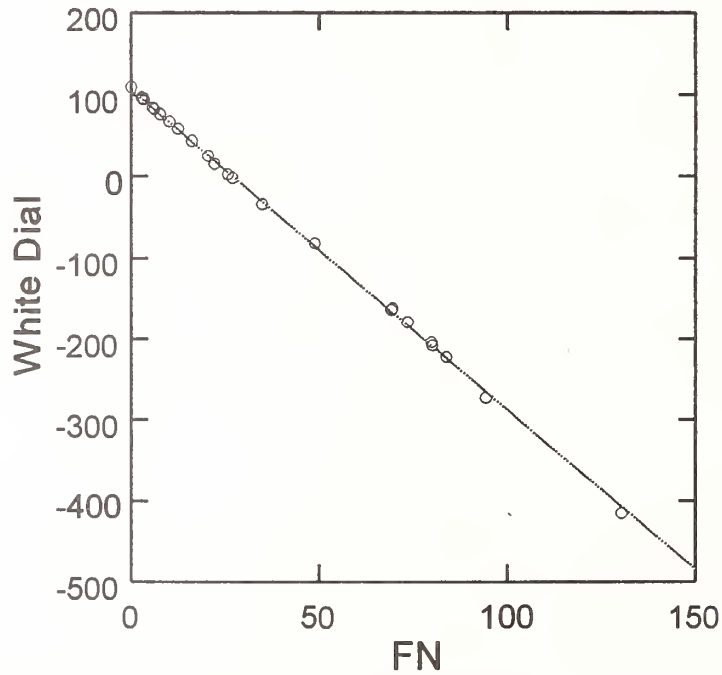

Figure 6. Calibration data for gage 2 using offset white-dial values to allow a continuous linear fit of data over the 0 to 100 FN range.

Although this offset procedure is not mentioned in AWS A4.2, it clearly follows the intent of the standard to have similar slopes. From a statistical standpoint, it is hoped that this procedure will improve the calibration, because more data are included and the data are continuous over the region of interest, 0 to 100 FN. However, the deviation allowed by AWS A4.2 between the FN assigned to the primary reference materials and the calibration line is small, so fitting a single calibration line over the whole FN may not always be possible.

For this study, we decided that each gage would be calibrated for two FN ranges: 0 to 30 and 30 to 100 FN. To minimize the error at very low FN, only calibration data within the 0 to 30 range were used for the linear regression fits. To retain some of the advantages discussed above, all the calibration data (0 to 100 FN) were used for calibration between 30 and 100 FN.

The equations that best fit the calibration data for gage 1 and gage 2 are given in eqs (2) to (5):

$$\begin{array}{l} \text{Gage 1} \\ \text{FN} = 27.35 - 0.247 \text{ (WD)} \quad \text{for 0 to 30 FN,} \quad (2) \end{array}$$

$$\text{FN} = 28.30 - 0.261 \text{ (WD)} \quad \text{for 0 to 100 FN,} \quad (3)$$

$$\begin{array}{l} \text{Gage 2} \\ \text{FN} = 26.33 - 0.244 \text{ (WD)} \quad \text{for 0 to 30 FN,} \quad (4) \end{array}$$

$$\text{FN} = 27.04 - 0.252 \text{ (WD)} \quad \text{for 0 to 100 FN,} \quad (5)$$

where WD is the white-dial reading of the gage.

Overall the fits are good, as indicated by the relatively small differences between the predicted and assigned FN values for primary reference materials (Figures 7 through 10). The standard errors for the slopes of eqs (2) through (5) were typically 0.001. The R-squared values for the equations all exceeded 0.999.

Both eq (3) and eq (5) come very close to satisfying the tolerances required by AWS A4.2 over the range of 0 to 100 FN. However, neither equation fully meets the allowed tolerance of ± 0.40 FN between 0 and 5 FN. The largest error for eq (3) in the 0 to 5 FN range is -0.51 FN. For eq (5), all calibration points meet the required tolerances of AWS A4.2, except the 0 FN point which has an error of -0.58 FN. The errors are reasonable, but the lack of full compliance for the extended FN equations (eqs (3) and (5)) makes it necessary to use eqs (2) and (4) for FN calculations within the 30 FN range. These equations are both well within the required tolerance of AWS A4.2.

The two equations that best fit the 0 to 30 FN data (eq (2) and eq (4)) have slightly lower slopes than the equations developed for the higher FN range (eq (3) and eq (5)). This suggests that the calibrations are not ideal. (The error plots in Figures 8 and 10 show trends at low FN, confirming that the data are better fit by two lines having slightly different slopes. But, six calibration points for gage 2 between 0 and 10 FN have errors very near to 0).

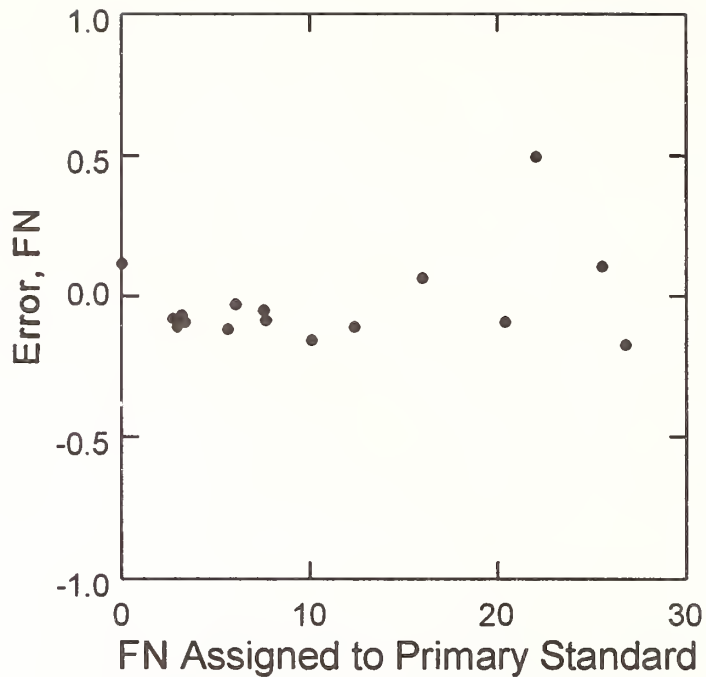

Figure 7. The difference in the FN assigned to the primary reference materials and FN calculated from eq (2) for the range 0 to 30 FN (gage 1).

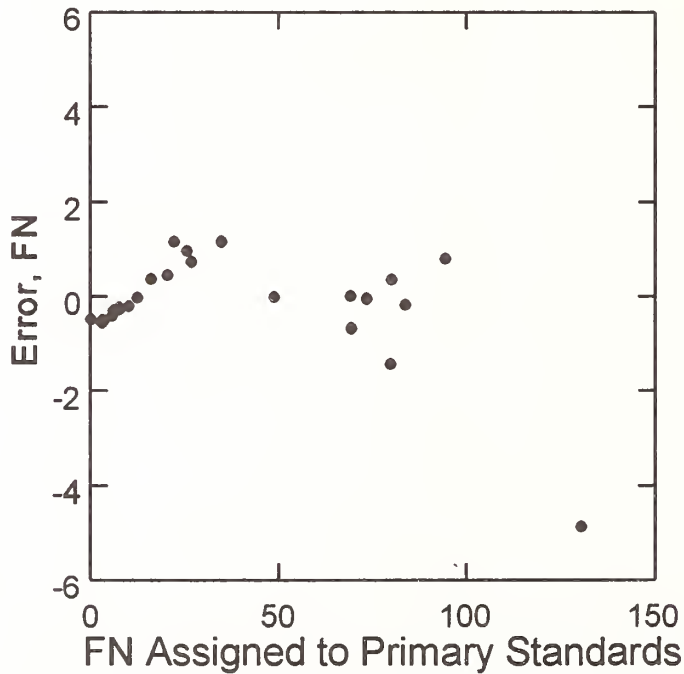

Figure 8. The difference in the FN assigned to the reference material and FN calculated from eq (3) for the range 0 to 100 FN (gage 1). Only data of 100 FN or less were used for fitting.

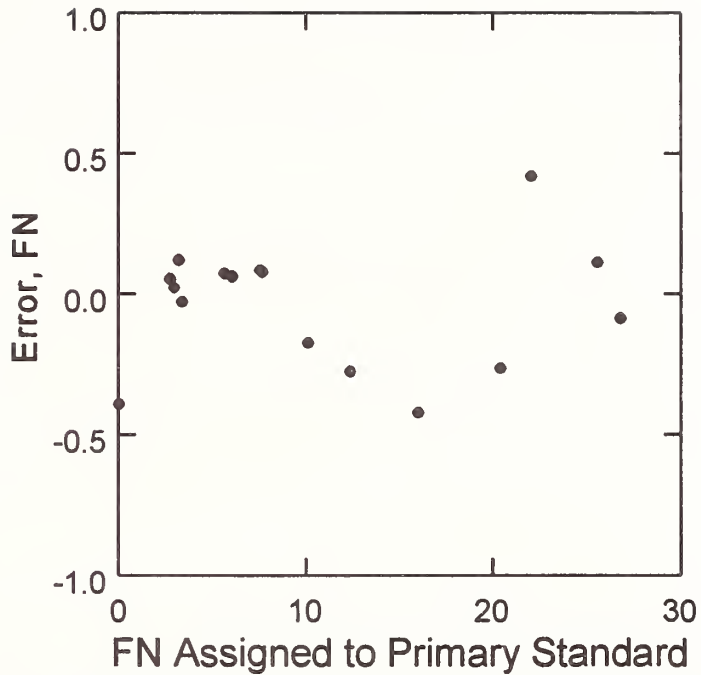

Figure 9. The difference in the FN assigned to the standard and FN calculated from eq (4) for the range 0 to 30 FN (gage 2).

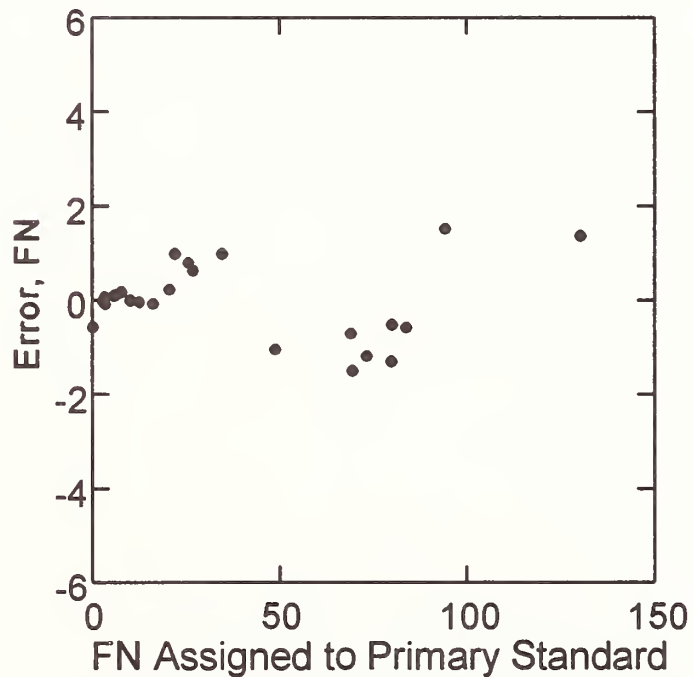

Figure 10. The difference in the FN assigned to the standard and FN calculated from eq (5) for the range 0 to 100 FN (gage 2).

3.4 Calibration Errors and Variables

The major contributors to errors in the calibration of the gages include: operator measurement error (and bias), uncertainty in the thickness of the primary reference materials ($\pm 5\%$ of the coating thickness), errors due to the gage, errors due to magnetic effects, and errors associated with the coefficients determined for the line fits.

Some differences in the measurements made by the two operators are apparent in the data. As shown in Figure 11, one operator tends to measure the FN slightly lower than the other. Hopefully, the average of the measurements for the two operators is near the average that would be found for a larger population of operators measuring the samples. Since these differences are to be expected for users of the reference materials, we did not change our measurement procedures or attempt to train the operators to produce more similar results. These data, however, show that the magnitude of the difference between operators is significant in relation to the maximum error allowed by AWS A4.2, and some influence of the gages and samples on the magnitude and sign of the differences are also apparent.

Sources of error due to the primary thickness reference materials used to calibrate the gages were evaluated by comparing the calibration measurements to the measurements from the 51 other primary reference materials (gathered from various sources, see Appendix D). All of the reference materials were measured by the same operator on the same gage, and then compared to the calibration data for the gage. As shown in Figure 12, there are no significant outliers in the data. Equations for lines fit to the calibration data and the independent data (51 other primary reference materials) are virtually identical. We conclude that all the primary FN standards used for our calibrations are within the $\pm 5\%$ thickness tolerances expected of them.

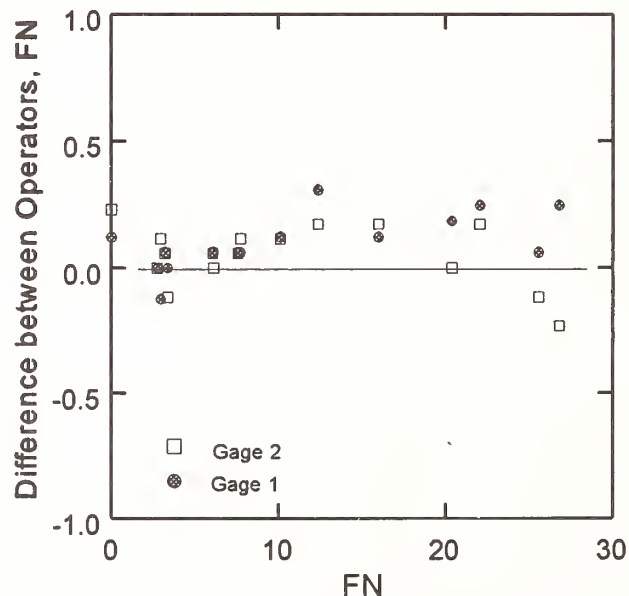

Figure 11. The difference between the measurements for operator 1 and 2 is shown for the two gages.

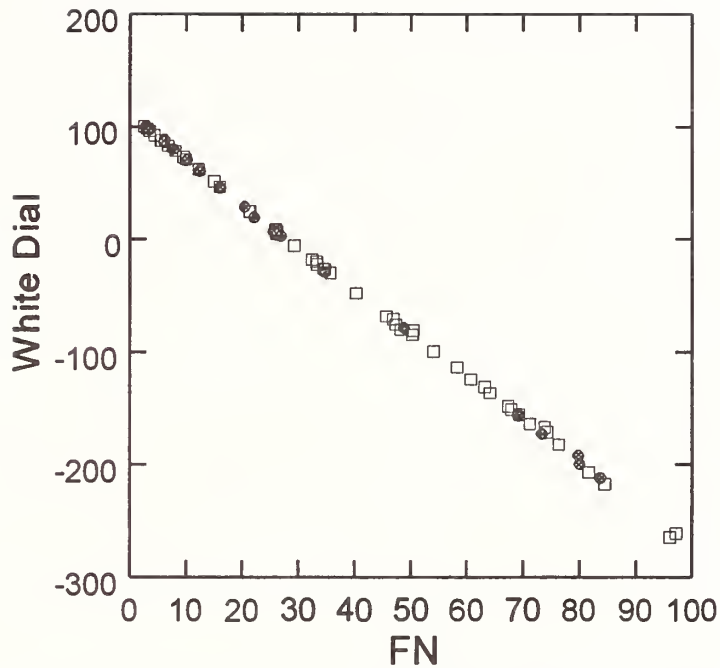

Figure 12. The primary reference materials used for the calibration of gage 1 (shown as solid dots here) are compared to 51 other primary reference materials.

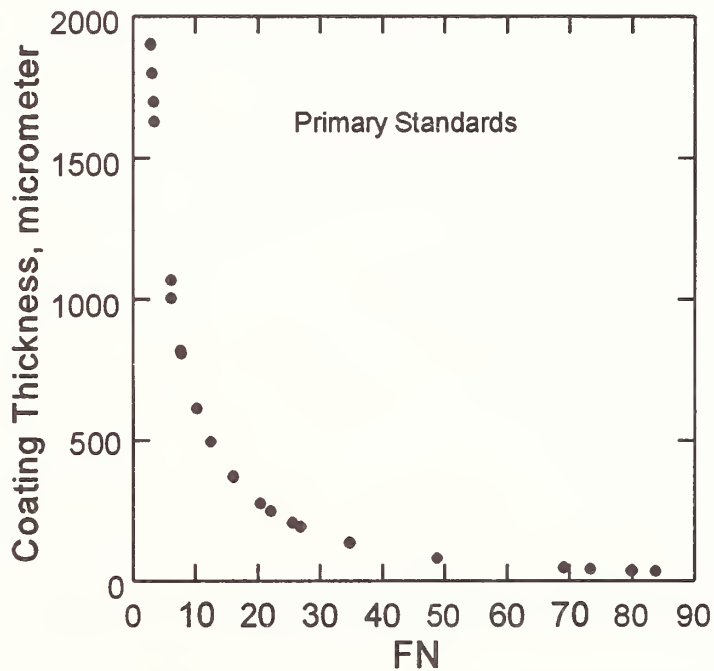

Figure 13. The relationship of the coating thickness of the primary reference materials to the FN calculated by eq (1).

The difference in the 0 FN measured for the gages (Figures 7 and 9) and the lowest FN primary reference materials measured is typically greater than 0.2 FN, which is large, considering that only a ± 0.4 FN error is allowed in the 0 to 5 FN range for primary gage calibrations. Although better agreement in this critical low FN range would be desirable, the lowest FN primary reference materials used for our calibration are well within $\pm 5\%$ uncertainties certified for their thicknesses. At 2.5 FN (2 mm coating thickness), for example, a $\pm 5\%$ error in the thickness of the standard translates to about a 0.4 FN difference. This points out the importance of determining accurate 0 FN data for these gages (to help weight the calibration data), and indicates that primary reference materials with lower uncertainties in the very low FN range are needed to more accurately calibrate the commercially important 0 to 10 FN range.

Accurate measurements of the thickness of the nonmagnetic coatings become more difficult as the thickness decreases. Fortunately, the relationship between the thickness of the primary reference materials and FN (Figure 13) is more tolerant of measurement errors as thickness decreases (FN increases). Although small differences in thickness have a more pronounced effect on FN, a larger error in FN can be tolerated in this region (high FN range). This is because the accuracy of the measurement is less critical to the performance and properties of high FN alloys.

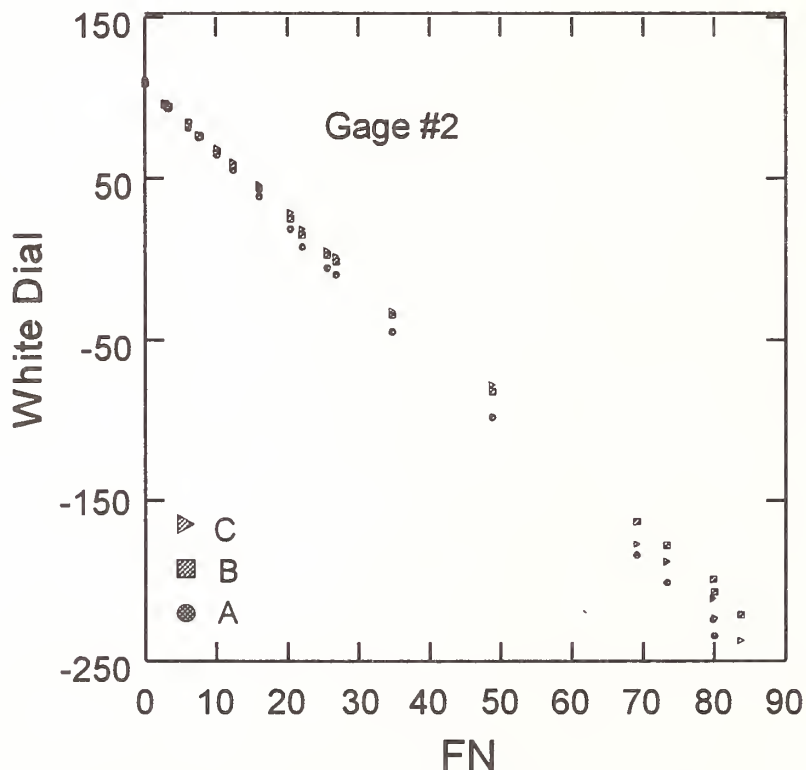

Figure 14. The white-dial versus FN for the A, B, and C magnets are shown for Magne-Gage #2.

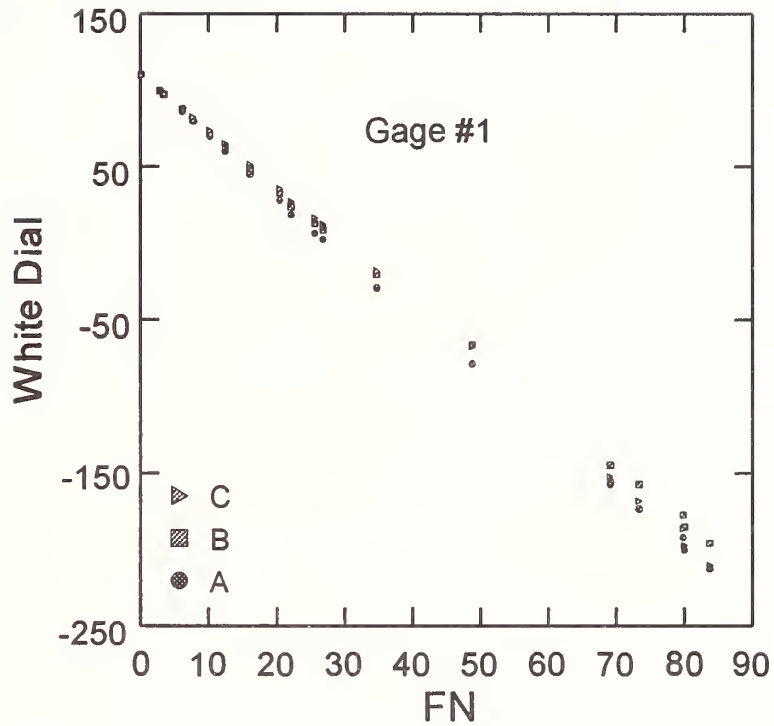

Figure 15. The white-dial versus FN for the A, B, and C magnets for Magne-Gage #1. The A, B, and C magnets are all #3 magnets.

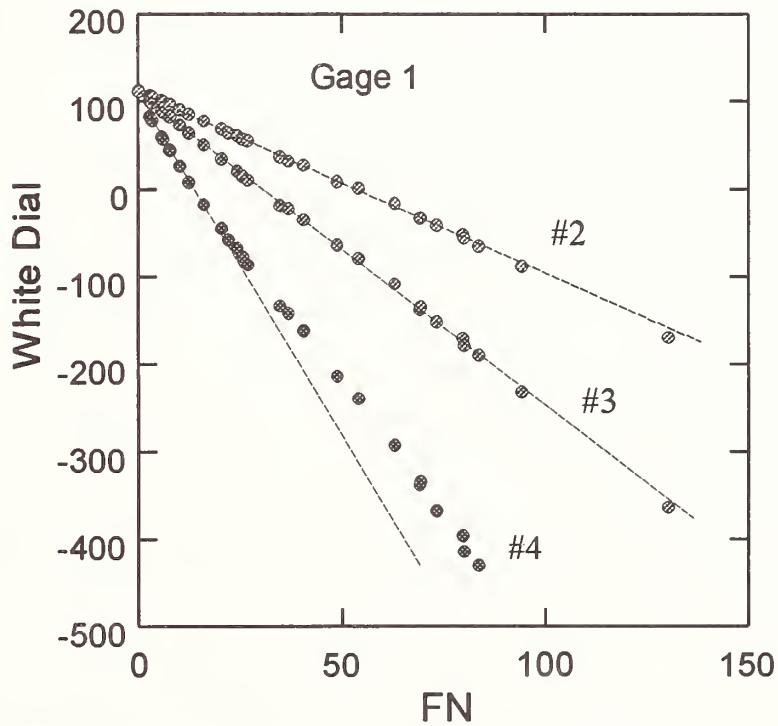

Figure 16: The effect of using #2, #3, and #4 magnets on gage calibration data (magnetic strength increases with magnet number).

The strength of the magnets used on the gages also affects the calibrations. As shown in Figures 14 and 15, using #3 magnets of slightly different strengths (all within the tolerance allowed for #3 magnets) results in different calibrations for the gages. As long as the calibration data is linear, this does not present a problem. However our evaluation of significantly stronger magnets (#4 magnets) indicated that magnet strength has an effect on the linearity of the calibration data. In Figure 16, the calibration data for a #4 magnet is shown to diverge from the line drawn to fit the low FN data (FN < 20). As already discussed, the data for the #3 magnets (our calibration data) are also best fit by two lines, but are quite linear over the 0 to 100 FN range compared with data for #4 magnets. It appears, however, that magnet/sample interactions effect the linearity of the calibration, and this would tend to increase the uncertainty of the calibration. The changes in slope of the data tend to occur at around 15 to 20 FN for the #4 magnets, and at 20 to 30 FN for the #3 magnets (on both of our gages). These FN ranges correspond roughly to the knee of the FN/coating-thickness in Figure 13.

3.5 Force Calibration

It is difficult to directly compare the gages used for FN measurement. The comparison can be simplified, however, by replacing the arbitrary white-dial values of the calibration plot with a force. By calibrating the white-dial scale in this manner, only the uncertainty in accuracy of the primary standard and the difference in the strength of the magnet used on the gage remains.

As shown in Figures 17 and 18, the relationship of the white dial to the force measured on the digital scale is linear, as would be expected by Hooke's law. This result is comforting and serves as an excellent check on the gage overall. For example, gage 2 (Figure 18) shows a slight undulation in the data, which is a result of a slight imperfection in the spring on this gage.

The overlaps in the data for the various counter weights used (0, 7, 14, 21, and 25 g) are also apparent in Figures 17 and 18. At any point within these overlaps, the offset of the data sets can be determined. We also found that the zero for the gage was most consistently determined from force data, because much of the operator bias was removed from the measurement.

Rearranging the the terms of the linear equations developed from the white-dial and force data (Figures 17 and 18) we find that:

$$\begin{array}{ll} \text{Force} = 5.48 - 0.0494(\text{WD}) & \text{Gage 1} & (6) \\ \text{Force} = 5.01 - 0.0457(\text{WD}) & \text{Gage 2} & (7) \end{array}$$

Equations (6) and (7) show that for a given white-dial value, gage 1 applies more force at the sample than gage 2. Here, there is no effect of magnet strength, because the magnet never detaches from the steel mass. As the white dial is turned, the force lifting the mass is measured on a digital scale (see Figure 3).

Linear equations were developed for the force data and used to calculated the force for the white-dial values taken during the primary calibrations of the gages (primary reference materials

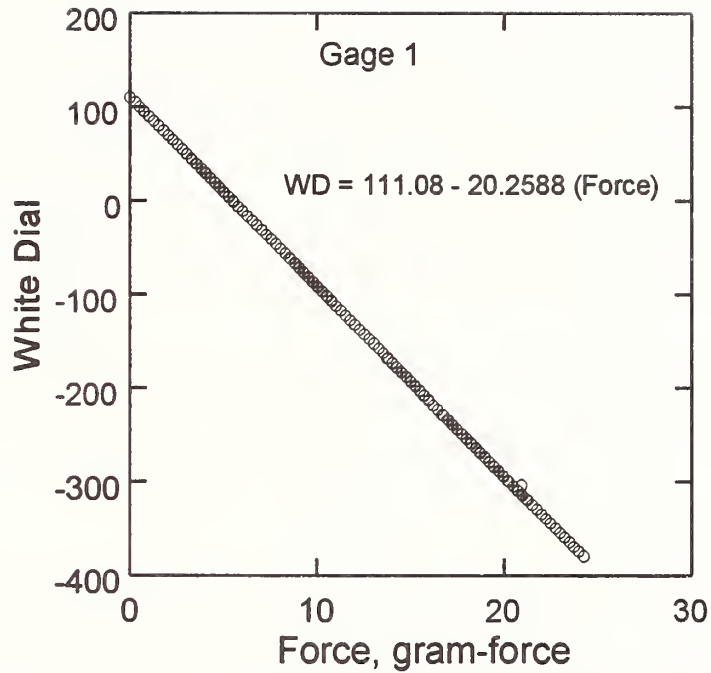

Figure 17. The relationship of the white-dial reading to the force measured using a digital scale for gage 1.

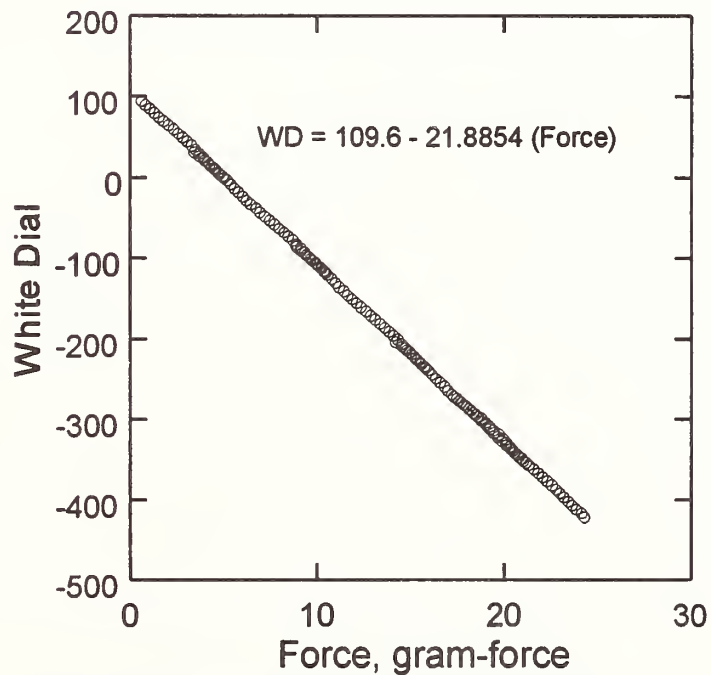

Figure 18. The relationship of the white-dial reading to the force measured using a digital scale for gage 2.

calibration). The force data were substituted for the white dial data and plotted against the FN data for the primary calibrations in Figures 19 and 20. The result is a plot for which both the X and Y axes are traceable to calibration standards. The arbitrary white-dial scale has been eliminated.

In terms of force, the data in Figures 19 and 20 show that a greater force is needed to pull the magnet off a sample of given FN for gage 1. This difference is attributed to the stronger magnet on gage 1 than on gage 2.

In terms of FN, the magnitude of the slopes for the data reverses:

$$\text{FN} = -0.57 + 5.27 (\text{Force}) \quad \text{Gage 1,} \quad (8)$$

$$\text{FN} = -0.61 + 5.52 (\text{Force}) \quad \text{Gage 2.} \quad (9)$$

These slopes, 541 and 561 FN per newton (5.27 and 5.52 FN per gram-force), for gages 1 and 2 respectively, are defined as the detachment force by AWS A4.2, but are actually a calibration factor. A decrease in the calibration factor relates to an increase in magnet strength. At an FN of 80, for example, the calibrations indicate a 1560 N (15.3 g-force) is needed to detach the magnet on gage 1, and a 1490 N (14.6 g-force) is needed to detach the magnet on gage 2. The differences in the applied force needed to detach the magnets decrease with decreasing FN.

The intercepts for the lines in Figures 19 and 20 are not equal to 0. Both lines have intercepts of 0.11, which we attribute to chance. (Note that fitting only the low FN data would result in different slopes for both gages, and these lines would intercept nearer to 0 FN.) These results simply reflect that the changes in slopes apparent in the calibration data plotted in Figures 5 and 6 remain after the force calibration.

3.6 Summary of Primary Calibrations

Overall we conclude that the gage calibrations are within the accuracies required by AWS A4.2, and that we can certify secondary reference materials using these gages and calibrations which will have accuracies that will meet or exceed those of past producers of these materials. This conclusion is supported by practical verifications we performed to check the performance of our gages. For example, when the FNs calculated using gages 1 and 2 are compared (Figure 21), only slight differences are apparent and the FN values calculated for these gages are in good agreement throughout the 0 to 100 FN range. To verify that our gages compared well to gages previously used for certifying these materials, FN was measured on TWI secondary reference materials. As shown in Figure 22, FN measurements made on our gage 1 agree well with the certified values assigned to the specimens by TWI. The agreement for the gage 2 data showed a similar trend. This result indicates there will be continuity between the FN values that assigned by NIST and those assigned by TWI.

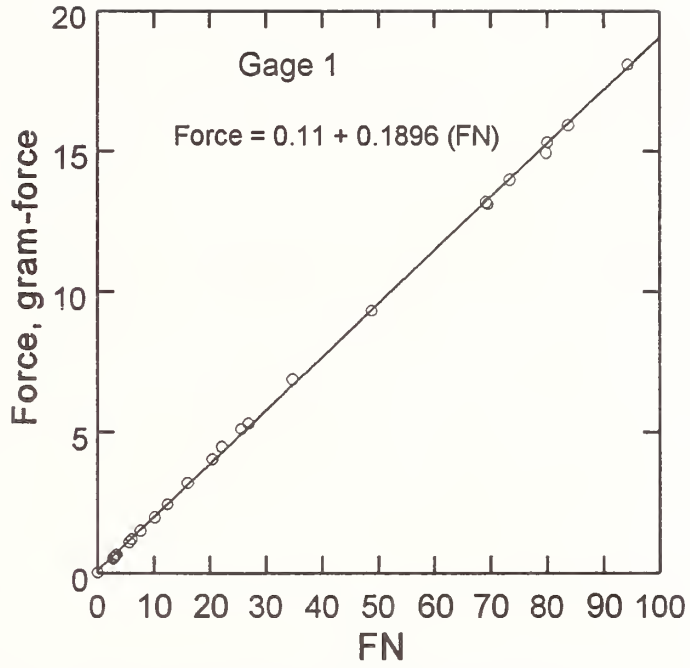

Figure 19. The relationship of force to FN for gage 1.

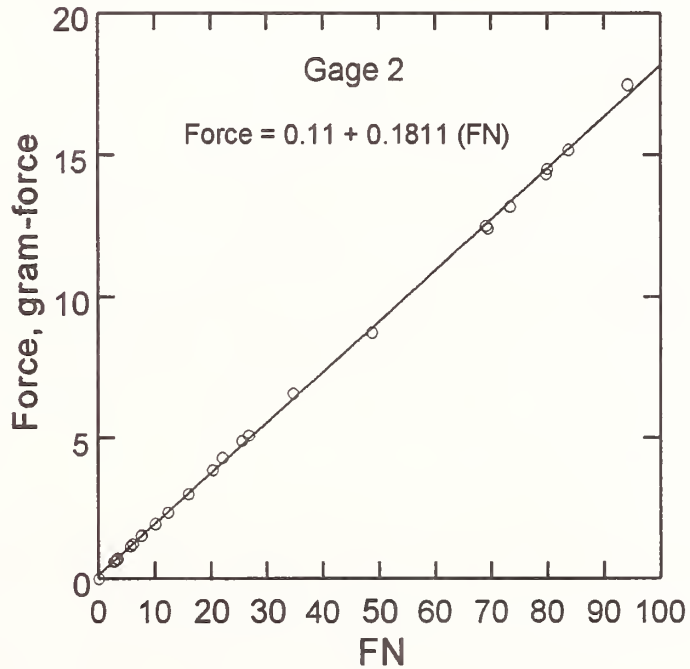

Figure 20. The relationship of force to FN for gage 2.

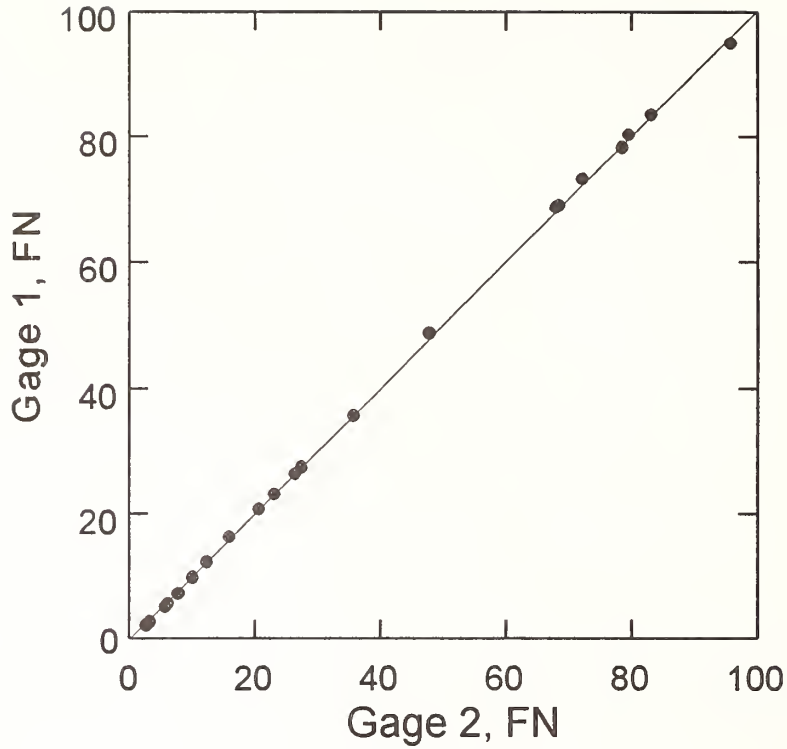

Figure 21. The FN calculated using eqs (2) and (3) for gage 1 and eqs (4) and (5) for gage 2.

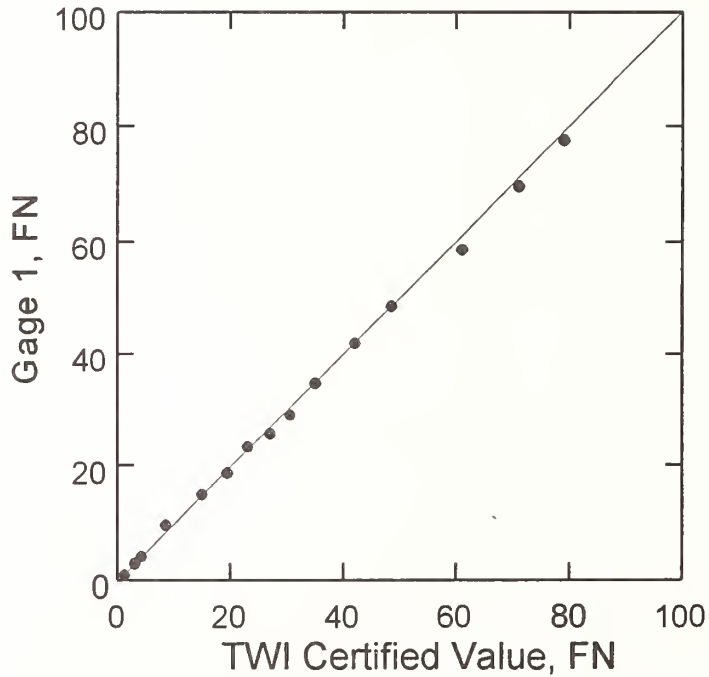

Figure 22. The FN measured by gage 1 plotted versus the FN certified by TWI.

Clearly, the use of commercial gages and the current calibration practices are not ideal for use in our FN reference material program. At this point, there is not an adequate understanding of the variables contributing to calibration error, particularly those influencing the linearity of the calibration. However, we are satisfied with the performance of our gages and our calibration procedures (for now).

We find several of the calibration procedures that we incorporated into our program useful, and suggest that they be considered as requirements (or recommendations) in AWS A4.2. Specifically, we find that adding the extra procedural step of force calibration is useful and plan to continue to track the performance of the gages in this manner. It provides detailed information on the linearity of the gages, a way to separate magnetic coupling variables from mechanical variables, and a means to better compare the gages to one another. Torsion balances have been evaluated in the past for FN measurement, so this more direct approach is not new [3]. But, by simply adding a force calibration to the existing procedure for calibrating white-dial gages, the best of both types of measurement devices can be realized: the accuracy and design of the Magne-Gage-type gages, and the traceability of the force calibration for the true torsion balance.

In addition, the determination of 0 FN using a balance (rather than operator judgement) and the use of continuous 0 to 100 FN data for the calibration of gages for high FN measurements should be considered in AWS A4.2. The use of a balance to determine 0 FN is simple and removes operator bias for this critical datum. The use of continuous data in the calibration of extended FN ranges is more consistent with the principles on which the calibrations are based (linear), and will likely help reduce variations in slopes obtained when fitting smaller groups of calibration data (for various counterweights) independently.

4. Measurement of Secondary Reference Materials

4.1 Measurement Procedure

Measurements were made on the secondary reference materials in five positions, by two operators using two gages. As shown in Figure 23, the five positions are clustered about the center of the specimen face. At each position, five measurements are made (by each operator on each gage), but only the lowest repeatable measurement of the five is retained. (This portion of the procedure is to screen out measurements for which the magnet detaches prematurely, in accordance with AWS A4.2.) In all, 100 measurements were made on each standard, but only 20 were retained for the permanent data record and the calculation of the certified FN value.

4.2 Data Analysis

The data for a secondary standard are evaluated by calculating the mean and standard deviation (STD) for each gage and operator combination, and each specimen position. In the example data record shown in Table 2, these calculations are shown by row and column, respectively.

Typically, the STD is lowest for measurements performed by the same operator on the same gage (row). This STD is the best indicator of variation in FN for the sample, because it is primarily due to differences in FN measured at the five specimen locations. These values are deemed particularly characteristic of the specimen when the STD for the four conditions (two gages, two operators) show similar variation. In this example, the measurements made with gage 2 by operator 1 have much higher variation than the other three conditions. This likely indicates a measurement error, and this is one approach used to check the data. The mean values are also helpful in detecting measurement errors, assuming the means for a given gage are similar if the operators have made good measurements. The mean and STD for the measurements made at a single specimen location (column) include variation due to the differences between the gages and operators. These values are the best indicator of how closely a customer measuring the standard might expect to match our measurement at a given sample location. (Users of the reference materials are instructed to make their measurements at the center of the sample face.) Therefore, the mean for specimen position 5 is defined as the certified value for the secondary standard.

A grand average and STD, and a pooled STD are also calculated. The grand average and STD for the 20 measurements made on the specimen provide our best overall estimate of the FN, and variation in FN because differences in FN due to sample location are also included. The pooled estimate of the variation in the specimen, S , is our best estimate of the variation in FN due solely to the sample. S is calculated as shown in eq (10), where s_1 to s_4 are the standard deviations calculated for the five measurements for each of the four operator-gage combinations.

$$S = \sqrt{\frac{s_1^2 + s_2^2 + s_3^2 + s_4^2}{4}}. \quad (10)$$

4.3 Data Trends

As we developed the certification data on the secondary reference materials, we were able to determine a representative measure of the standard deviation in the measurements for the batch. An overview of the data is presented in Figures 24 through 29. The various symbols used in these figures represent the rings from which the samples were taken.

In Figure 24, the grand standard deviations of the secondary reference materials are shown to increase with increasing FN. This trend is apparent in Figures 26 and 28 as well. However, the pooled standard deviations shown in Figure 26 indicate that the FN variation in the specimens do not necessarily continue to increase with increasing FN. The pooled standard deviations for the specimens show that above about 50 FN, the variation might be expected to remain below 3 for good specimens. Several specimens have high standard deviations, compared with other specimens of similar FNs. In particular, there is a group of specimens between about 50 and 60 FN that appear to be outliers. These data were reviewed for errors, and the specimens were remeasured. Most outlying measurements were found to be repeatable and had higher than average variation, so these specimens will not be used as secondary FN reference materials.

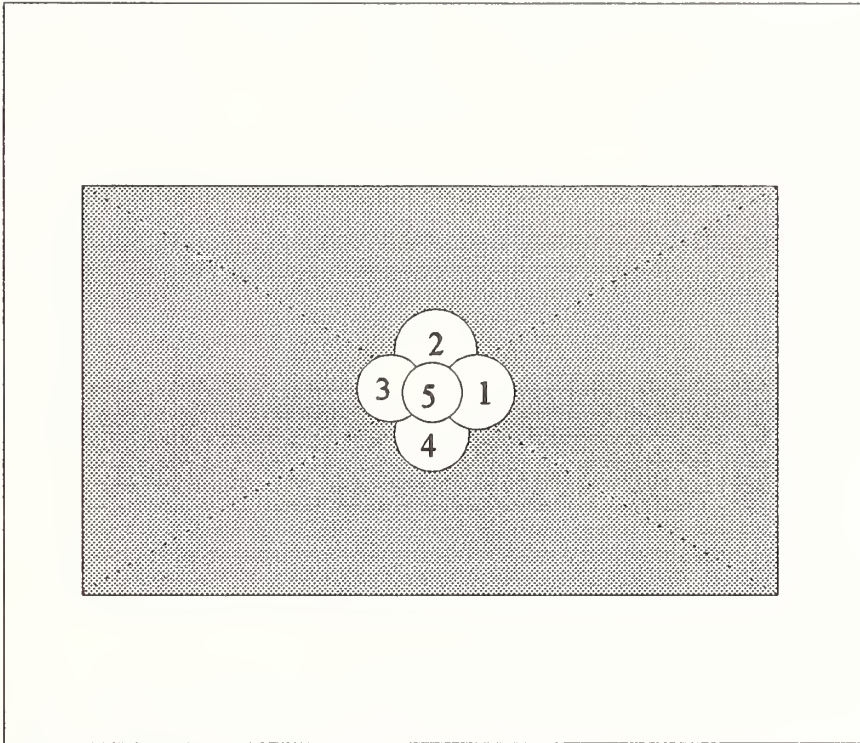

Figure 23. Measurements are made in the five positions shown, on the face of the standard that is opposite the identification number.

Table 2. Example data for a secondary FN standard. Statistics for each of the five positions (P1 through P5) are shown (units are FN).

Gage (Operator)	P1	P2	P3	P4	P5	Mean	STD
Gage 1, (1)	51.79	51.53	52.57	52.31	51.53	51.94	0.47
Gage 1, (2)	52.75	52.75	53.50	53.00	53.00	53.00	0.31
Gage 2, (1)	51.26	49.96	51.53	53.09	52.57	51.68	1.22
Gage 2, (2)	53.00	53.25	53.00	53.50	52.75	53.10	0.29
Mean	52.20	51.87	52.65	52.97	52.46	52.43	
STD	0.82	1.47	0.84	0.50	0.65		

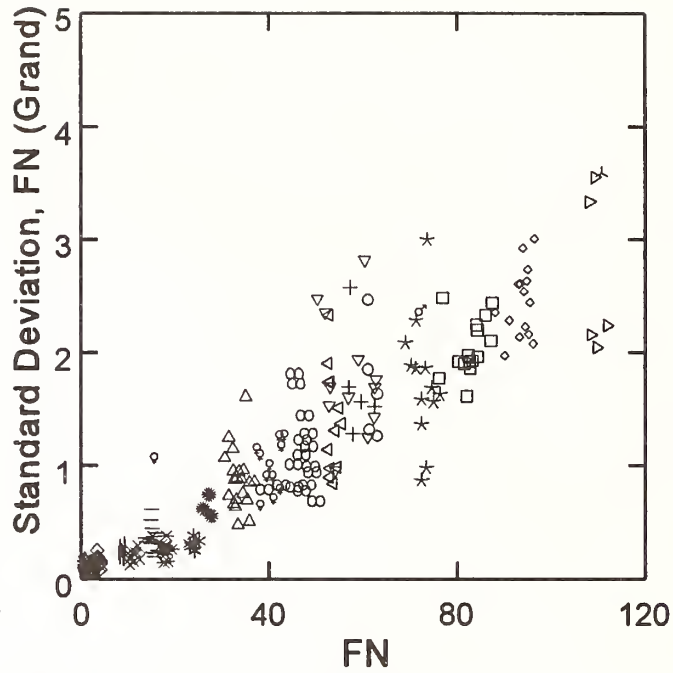

Figure 24. The grand standard deviation (STD of 20 measurements) for the batch of secondary specimens.

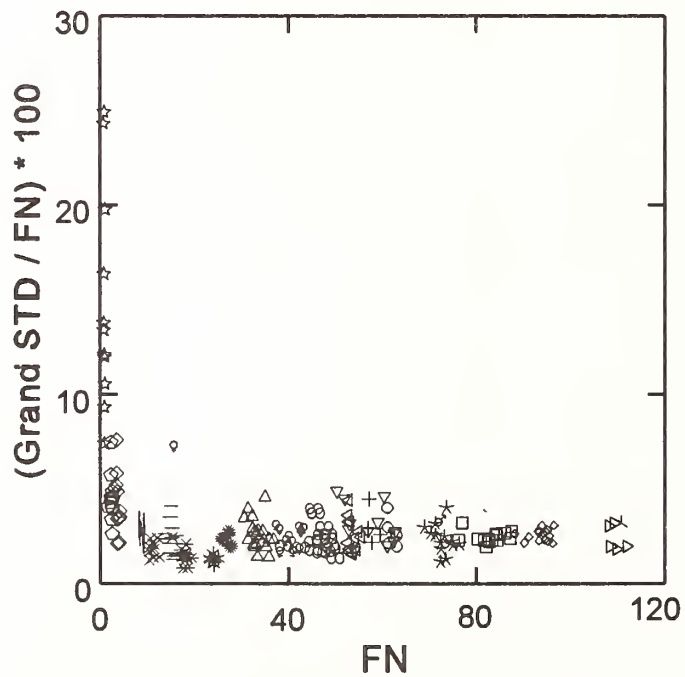

Figure 25: The grand standard deviation normalized by FN showing the larger relative variation for lower FN specimens.

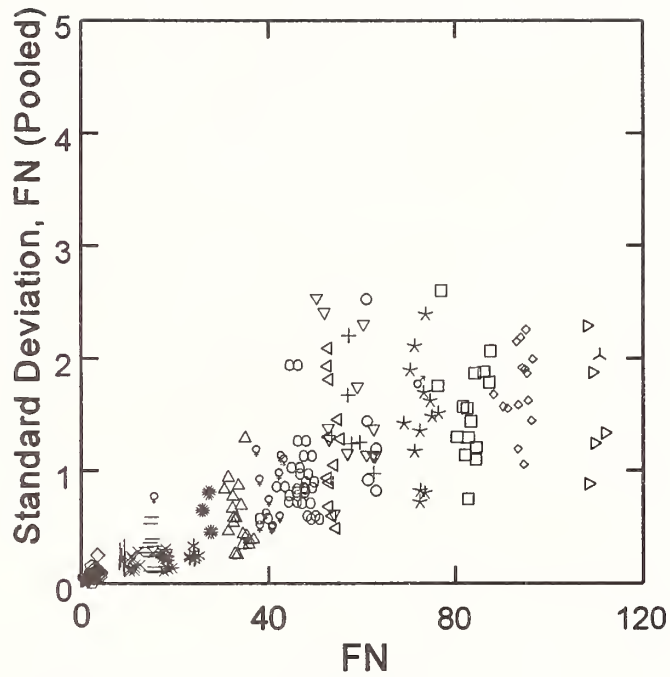

Figure 26. The pooled standard deviation for the batch of secondary FN reference materials showing variation similar, but often lower than the grand standard deviation for the specimens.

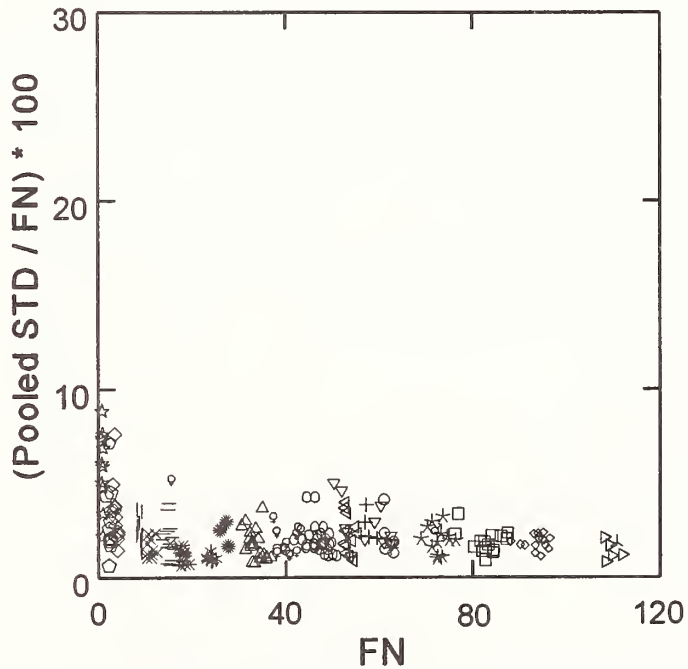

Figure 27. The pooled standard deviation normalized by FN.

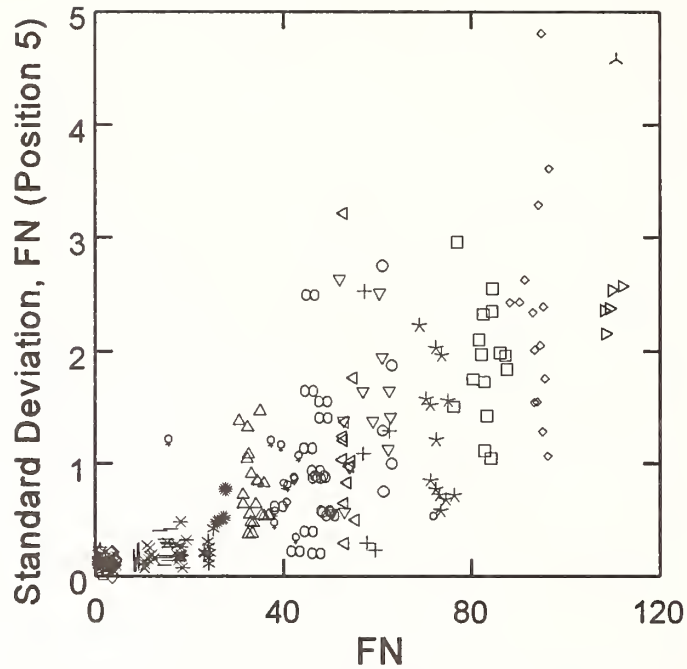

Figure 28: The standard deviation for measurements made at position 5 on the specimens.

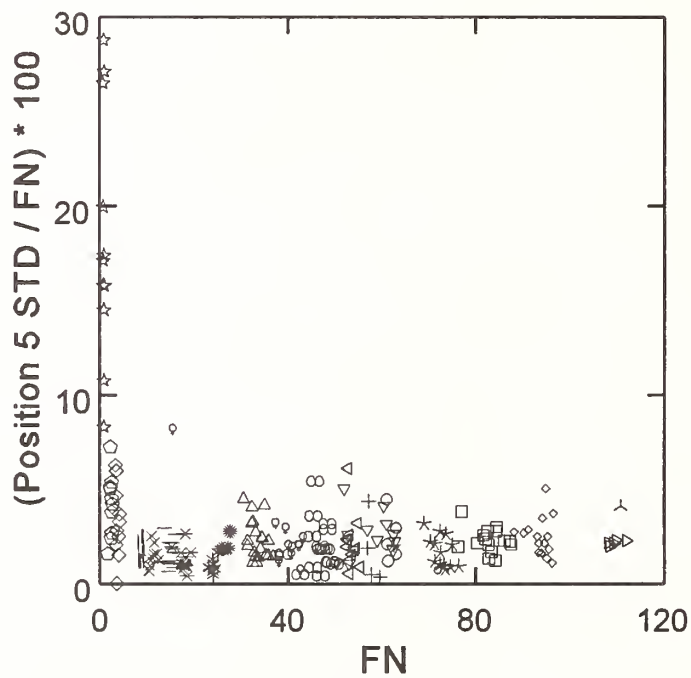

Figure 29. The standard deviation for the measurements made at position 5, normalized by FN.

In Figures 25, 27, and 29, the data are normalized with respect to FN. In Figures 25 and 29 the relative variation in FN is shown to be highest within the 0 to 5 FN range, indicating that the influence of different gages and operators on the FN measurements is most significant at low FN. The pooled statistics, Figure 27, show that the variation in the low FN specimens is less than half those that include gage and operator effects (Figures 25 and 29). This 10 % variation for the normalized pooled statistics (Figure 27) best represents the FN variation inherent to the specimens in the 0 to 5 FN range.

Since this is the first batch of secondary specimens for which these statistical data have been compiled, we can not compare the quality of these specimens with those of specimens produced in the past. The variation in the FN of the specimens does appear to be reasonable, considering the various requirements for measurement accuracy in AWS A4.2. These and future data will be used to develop better documentation on the quality of secondary FN reference materials. The data will also be used to support and to update the requirements of AWS A4.2.

5. Certification of Secondary Reference Materials and Discussion of Errors

Each set of FN reference material (RM) contains eight individual specimens. A table that accompanies the set provides three types of data on each specimen and a plot reflecting the calibration error. As shown in Tables 3 and 4 (examples of high and low FN sets), the average and STD for position 5, the pooled statistics, and the grand values are given for each specimen.

The FN value at the *center* of the sample (position 5) is defined as the reference value. The pooled statistics and grand averages are provided for information only, to more fully describe the variation in FN measurement within a specimen. The additional data are provided because the specimens will be used to calibrate several different types of instruments and it is not clear at this time which statistics may best support the users of these instruments.

5.1 Uncertainty Analysis

Measurement Repeatability (u_R): The Type A uncertainty in FN measurements taken at a single location (position 5) is due to differences in operators, gages, and magnets used on the gages. Here, u_R is equal to the STD at position 5. Example u_R data are given in Tables 3 and 4 for low- and high-range reference materials.

Calibration Error (u_C): The Type B uncertainties in FN measurements due to sources of bias include: (1) uncertainty due to variation in the thickness of the coating thickness reference materials used to calibrate the gage, (2) the uncertainty of the dial readings on the gage, and (3) the uncertainty related to the fit of the calibration curve.

The calibration errors shown in Figures 30 and 31 were determined by simulation. A triangular distribution (± 0.5) was used to model the thickness of the primary standard, and another triangular distribution (± 0.5) was used to model the error of the dial readings from the gage. The

Table 3. Example certificate for a 0 to 30 FN reference material set.

Level	Specimen ID	Reference Values average and standard deviation (FN, position 5)		Pooled statistics of specimen positions (FN)		Grand average and standard deviation (FN)	
		Avg	u_R	Avg	S	Avg	St.D
1	16 - 1002	0.7	0.14	0.7	0.06	0.7	0.12
2	17 - 762	2.5	0.09	2.5	0.08	2.5	0.12
3	15 - 222	3.6	0.07	3.4	0.13	3.4	0.13
4	18 - 153	8.3	0.10	8.3	0.21	8.3	0.20
5	7 - 1127	11.6	0.25	11.5	0.17	11.5	0.24
6	19 - 156	14.8	0.33	14.8	0.11	14.8	0.32
7	26 - 1653	18.2	0.26	18.1	0.24	18.1	0.29
8	27 - 1071	26.2	0.52	27.1	0.81	27.1	0.75

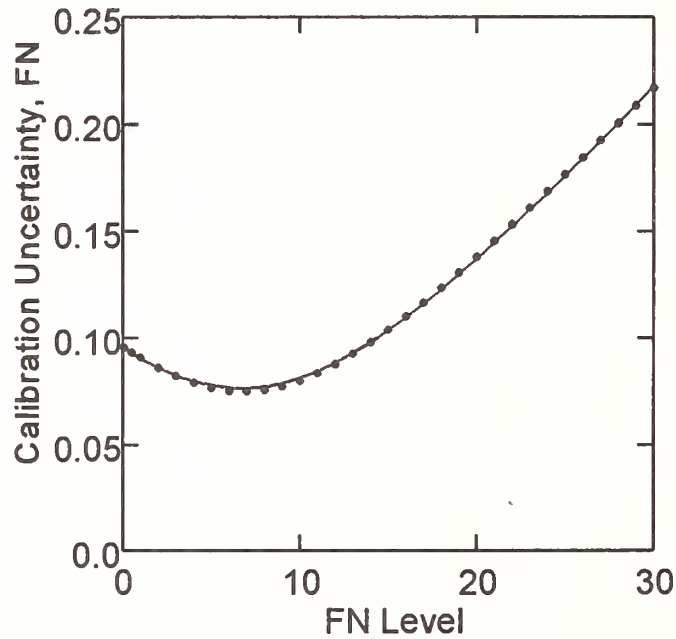

Figure 30. Simulated calibration error for 0 to 30 FN.

Table 4. Example certificate for a 30 to 100 FN reference material set.

Level	Specimen ID	Reference Values Average and Standard Deviation (FN, position 5)		Pooled Statistics of Specimen Positions (FN)		Grand Average and Standard Deviation (FN)	
		Avg	u_R	Avg	S	Avg	St.D.
9	10 - 300	31.3	0.72	31.3	0.47	31.3	0.74
10	29 - 2044	38.4	0.48	37.2	0.93	37.2	1.11
11	30 - 2052	46.6	0.94	46.8	0.81	46.8	1.10
12	12 - 713	53.4	0.98	53.6	1.05	53.6	1.31
13	11 - 622	62.7	1.13	62.3	1.14	62.3	1.43
14	14 - 446	77.6	1.51	76.1	1.76	76.1	1.77
15	14 - 866	88.9	1.84	87.4	2.07	87.4	2.44
16	13 - 563	107.9	2.36	108.4	2.29	108.4	3.34

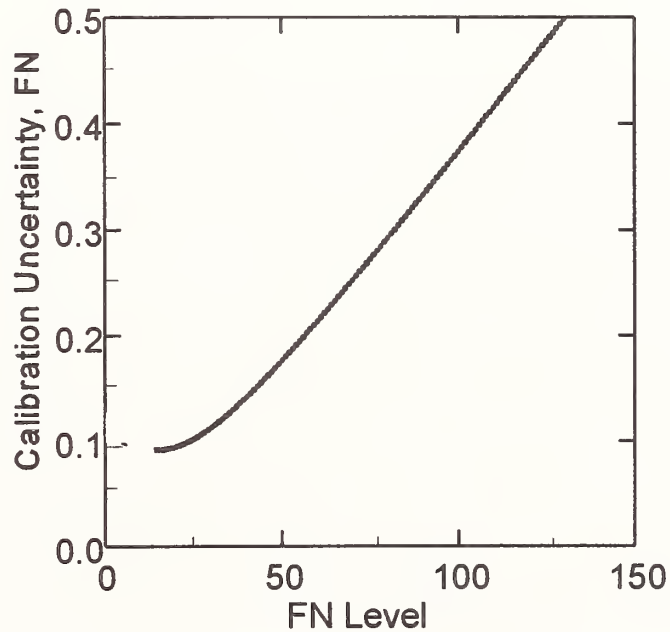

Figure 31. Simulated calibration error for 30 to 100 FN.

root-mean-square error of the calibration result, based on 10 000 Monte Carlo samples, was used as the calibration error.

Combined Standard Uncertainty (u): The two standard uncertainties (u_R and u_C) can be combined by quadrature addition to obtain the combined standard uncertainty (combined uncertainty). To determine the overall uncertainty for a given specimen, the measurement repeatability for the specimen given in Table 3 or 4 and the calibration error estimated for the FN level of the specimen in Figure 30 or 31 are combined using eq (11). For example, the combined standard uncertainty for sample 27-1071 (Table 3) is:

$$u = \sqrt{u_R^2 + u_C^2} = \sqrt{0.52^2 + 0.17^2} = 0.55. \quad (11)$$

6. Microstructure

We have examined the microstructures of secondary reference materials, selected over a broad range in FN. The samples chosen for these destructive evaluations also had high variation in FN. These samples are used to provide characteristic examples of microstructures for the various FN levels selected and to identify microstructural features that might explain the high variation in FN measured for the samples. Example microstructures for these specimens are shown in Figures 32 through 40. The specimens were prepared for both light microscopy and atomic force microscopy evaluations. The primary features of interest for these evaluations were the ferritic phase content and uniformity, the “grain size,” magnetic domain size, and solidification flaws.



Figure 32. Light micrograph of sample 14-888, 10 mm equal to 50 μm .

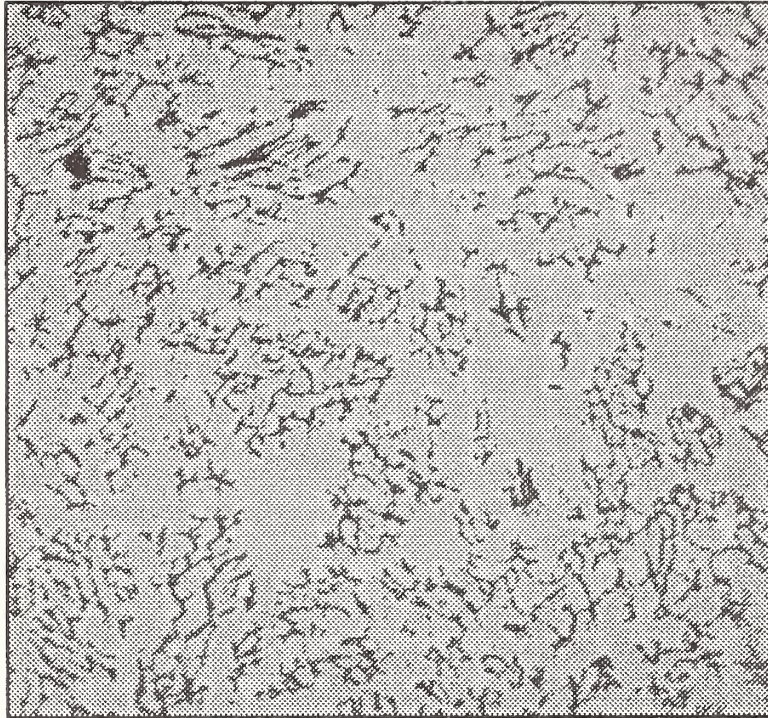

Figure 33. Ring 7, specimen 1268, FN = 9.9.

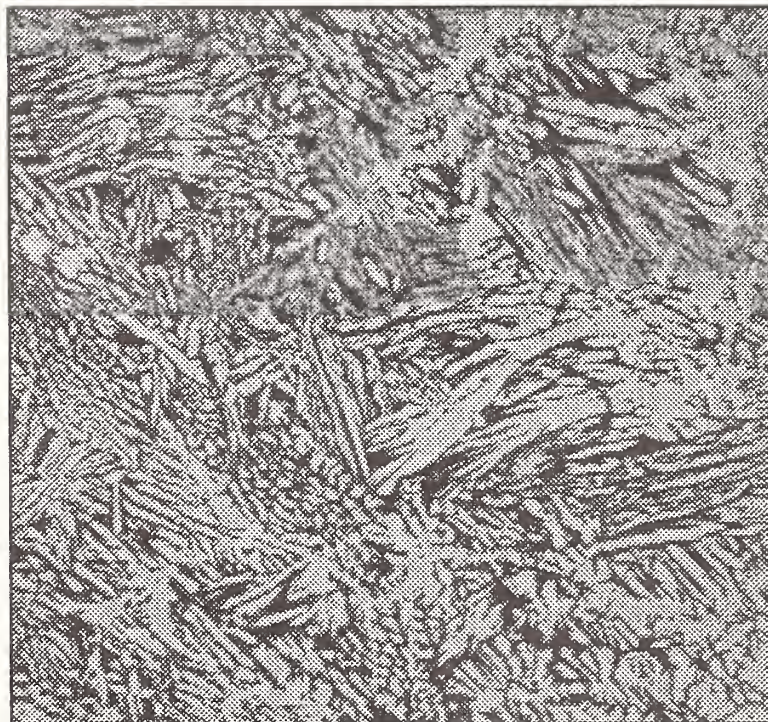

Figure 34. Ring 27, specimen 1732, FN = 26.

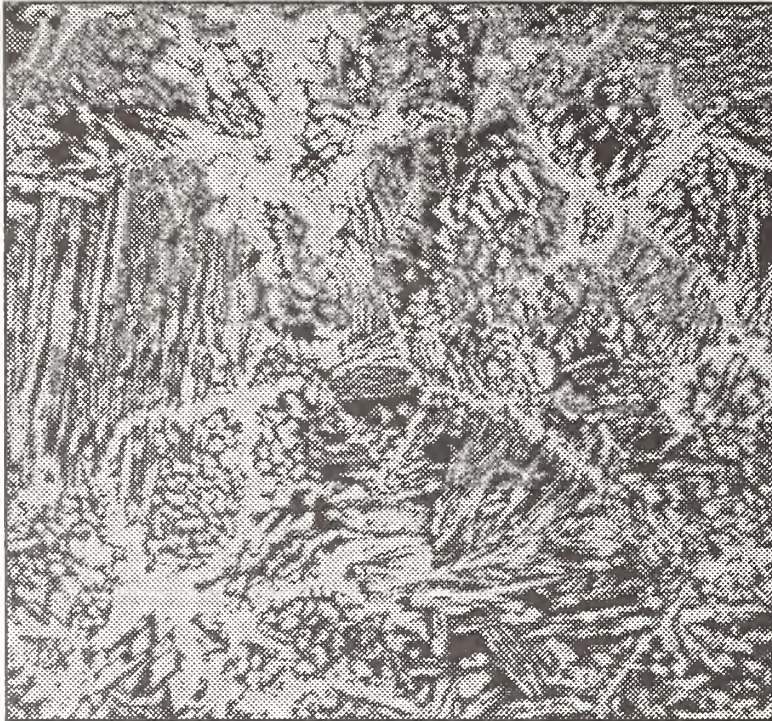

Figure 35. Ring 10, specimen 2029, FN = 35.

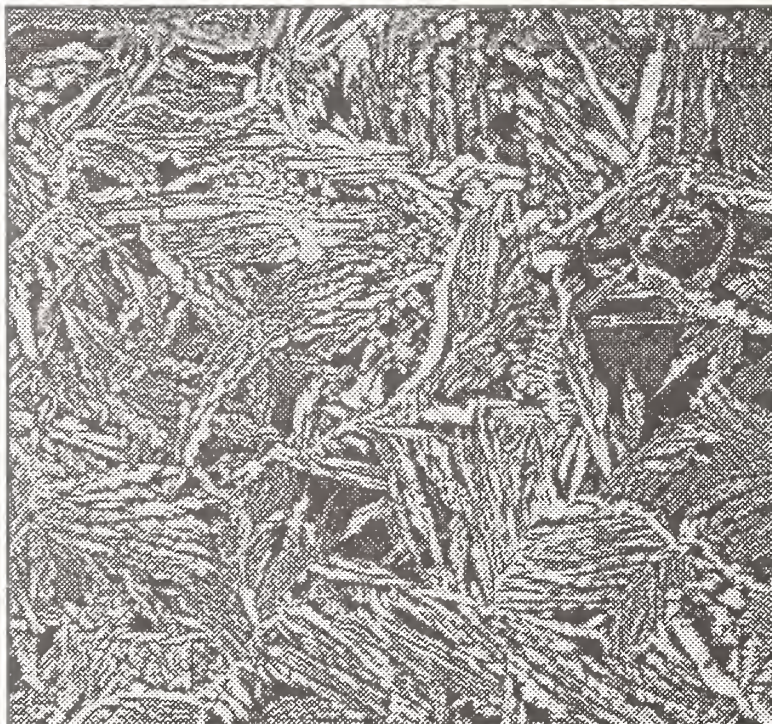

Figure 36. Ring 29, specimen 2043, FN = 43.5.

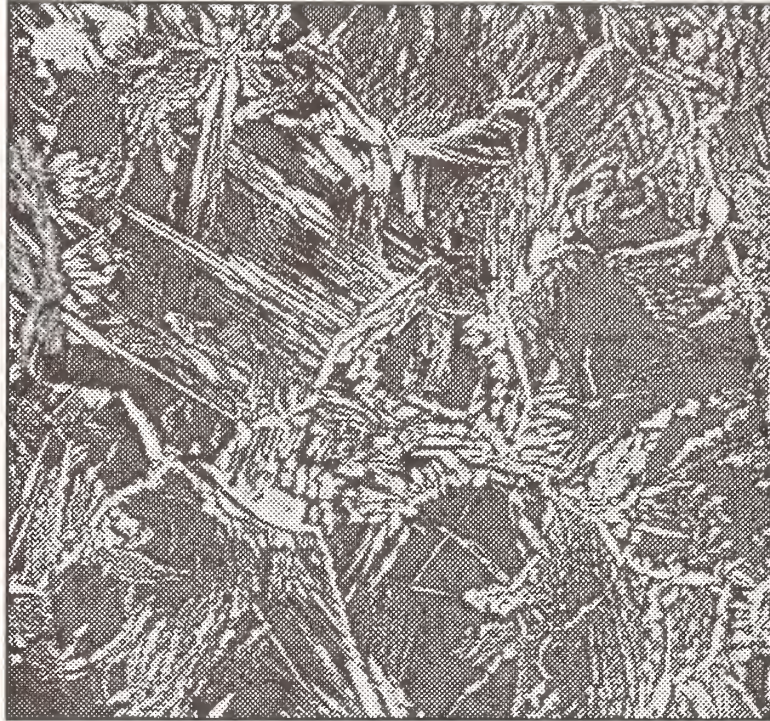

Figure 37. Ring 11, specimen 242, FN = 51.9.

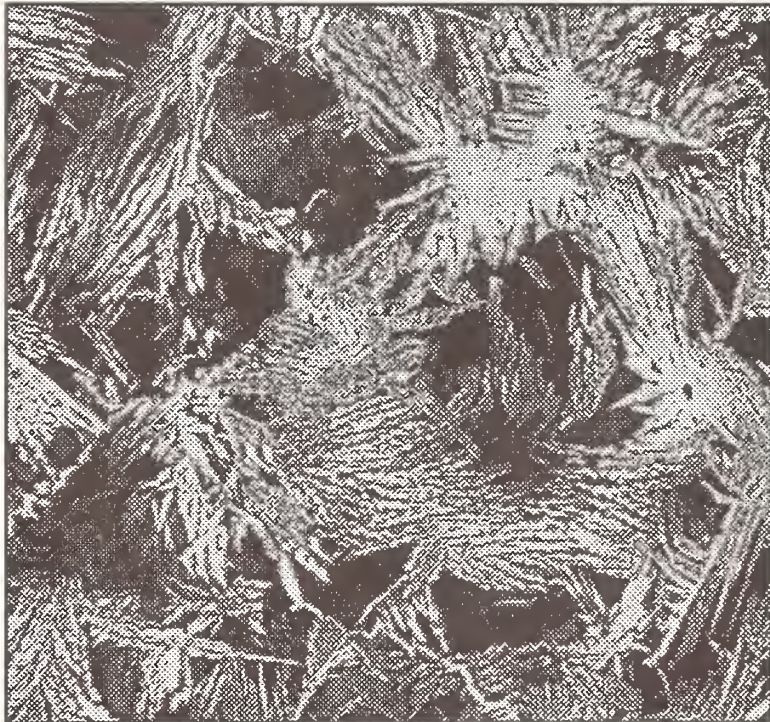

Figure 38. Ring 11, sample 918, FN = 60.3.

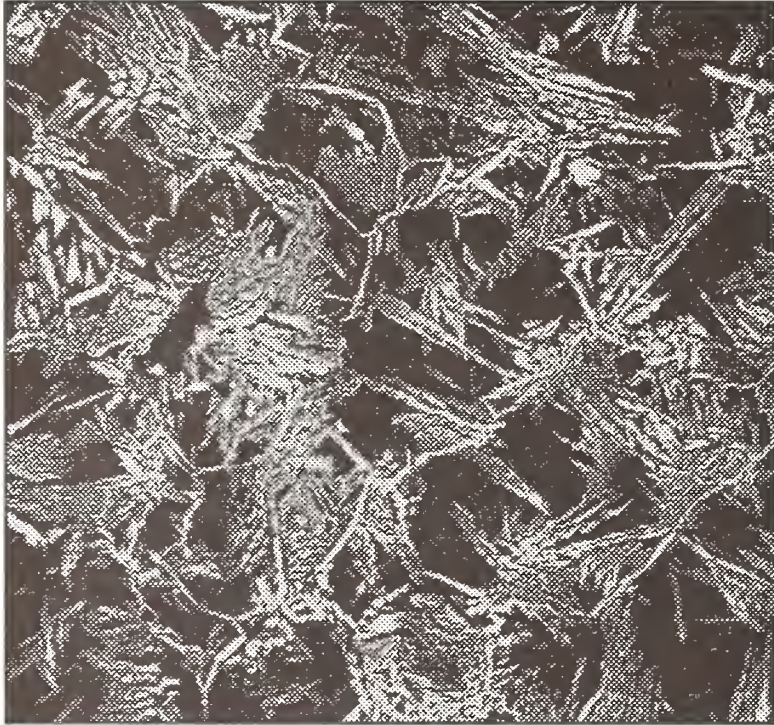

Figure 39. Ring 24, specimen 1581, FN = 73.6.

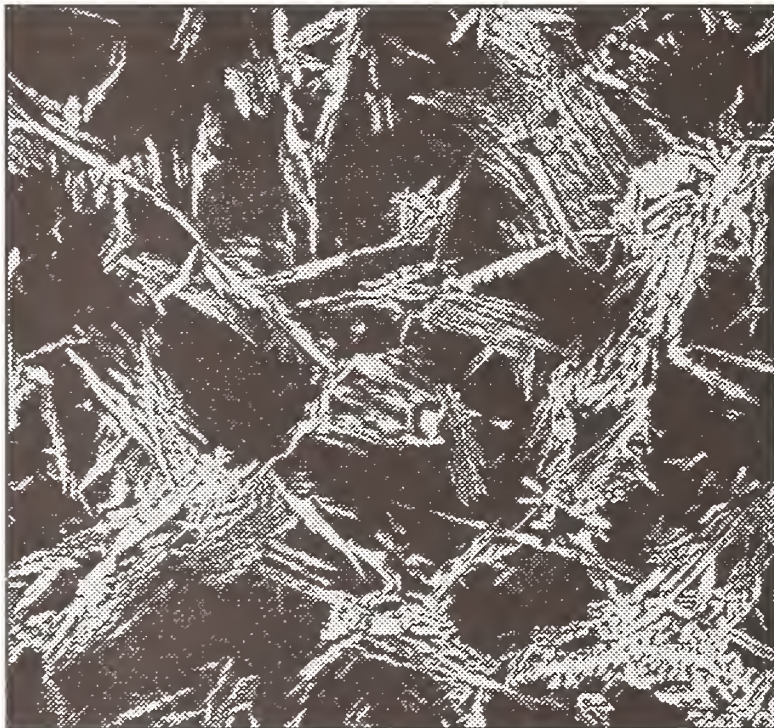

Figure 40. Ring 14, specimen 888, FN = 76.9.

6.1 Grain Size

The “grain size” (cell or dendrite packet size) is difficult to quantify in many of these microstructures. However, the grain size, which is delineated by differences in dendrite orientations, can be estimated qualitatively in many of the samples (particularly for specimens of 30 FN or more). Etching to enhance grain contrast was used occasionally to help delineate the boundaries (Figure 32), but in many of the alloys (Figure 35, for example) an almost continuous austenitic phase (white) marks the grain boundaries well enough to roughly estimate the grain size for our purposes. The changes in the ferrite/austenite morphology within the boundaries reflect variations in dendrite orientations, and this apparent grain size is clearly a good measure of the critical repeating microstructural features in the specimens.

The micrographs in Figures 33 through 40 are digital images (light microscope) that show typical grain morphologies for the specimens. The figures show regions of microstructure that are approximately 800 by 800 μm in size. The apparent grain diameters for the specimen shown in Figure 35, for example, range from about 100 to 300 μm . This range in grain diameter appears to be common to the specimens that were evaluated, and it is likely that the average grain size for the specimens is well below 300 μm . Assuming that the magnetic measurements made with the FN gage cover microstructural regions of near 1 mm^2 , then the relative scale of the ferrite/austenite morphologies are reasonable, particularly for specimens of less than 50 FN.

6.2 Ferrite Content

The ferritic phase content of the specimens was estimated using light microscopy and image analysis. The measurements were made on planes parallel to, and just below the plane on which the FN measurements were made. The specimens were lightly ground (800 grit) and polished to remove surface damage, then etched using a Beraha II solution for the evaluations. Area fraction counts were made at 2 different magnifications, and for each count 100 adjacent fields were measured.

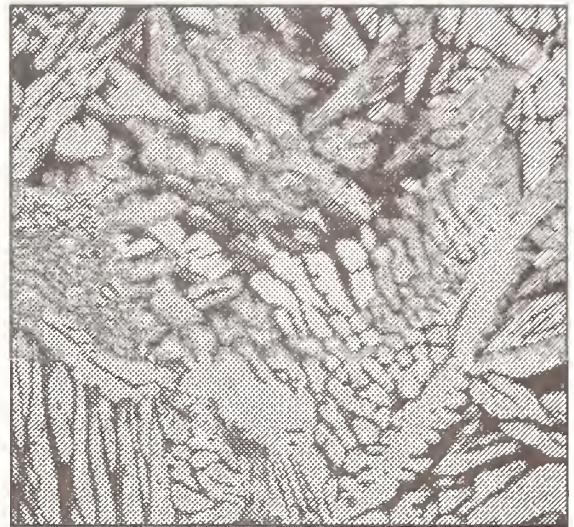

Figure 41. Example of a deeply etched microstructure for the specimens. Ring 12, specimen 697 (160 by 160 μm area).

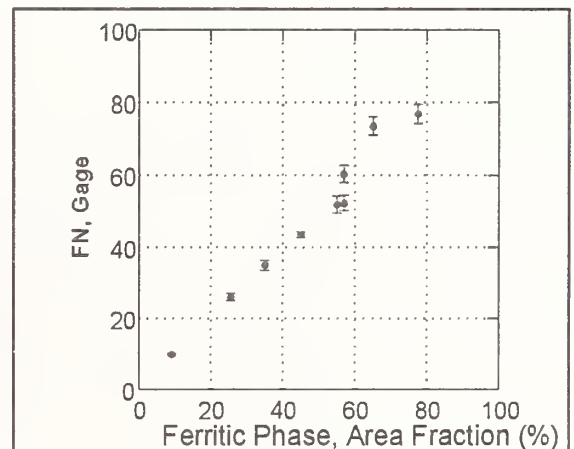

Figure 42. Area fraction of ferrite measured for the specimens. Values are the average of at least two counts (100 fields each).

For the lower magnification used, the total area of each count was about 2.5 mm² and for the higher magnification the total field area was about 0.64 mm².

Typically, several counts were made at each of the two magnifications. The influence of the etch (light versus deep etching condition) on the area counts was significant in some cases, as is always the case. However, with appropriate thresholding similar area fractions were counted for both conditions. The deeply etched samples (Figure 41) were found to provide excellent contrast for the analysis, particularly for the higher FN levels.

The results of the area fraction counts were somewhat surprising. As shown in Figure 42, we found a 1:1 correlation between FN and the ferrite area fraction measured (up to at least 50 FN). It was expected that above 10 FN, the two measurements would start to diverge, and by 50 FN be significantly different.* We remeasured several of the samples to check the result, and believe the results to be accurate (within about 5 %).

Three of the samples were evaluated by X-ray diffraction to determine whether they might contain sigma phase, which is non-magnetic and could be incorrectly identified (and counted) as ferrite in the light microscopy results. No sigma phase was present in the samples.

6.3 X-ray Evaluation

The secondary FN specimens were X-rayed prior to beginning our FN measurements to help screen out any samples that contained serious casting flaws. No specimens were excluded for use based on these results, but some characteristic differences in the specimen were apparent. As shown in Figure 43, some specimens have a much grainier, more textured appearance than others. This may be a result of compositional differences, which can change the primary solidification mode or influence the relative segregation of compositional elements in the cast. The different appearances may also be due to crystallographic alignment (texture) or networks of small casting defects, which might have characteristic differences due to the specific solidification conditions (and composition) of the ring from which the group of samples was taken.

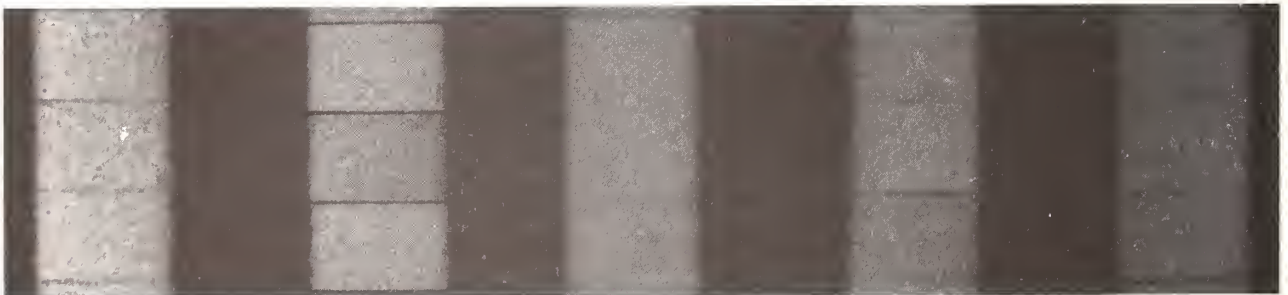

Figure 43. X-ray images of some of the ferrite reference samples.

* Area fraction counts of the percent ferrite in stainless steel weld have shown the percent ferrite and FN to be approximately equal up to 10 % ferrite. At levels of more than 10 % ferrite, FN measurements have been shown to over estimate the percent ferrite in welds (AWS A 4.2).

6.4 Solidification Flaws

Microstructural evaluations showed that the centrifugal cast FN specimens have solidification flaws, as might be expected. As shown in Figure 44, these flaws can be quite minor and would not be expected to result in significant deviation for FN measurements. Larger flaws, however, such as those shown in Figure 45, would likely result in variation for FN measurements. We expect that these types of flaws were the main reason for unacceptable variation in a few of the reference specimens. These specimens were rejected and used only for the microstructural studies.

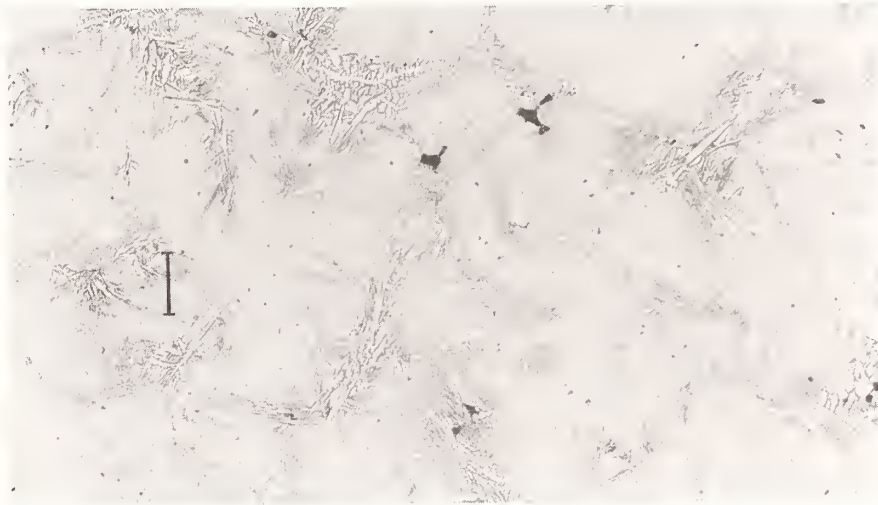

Figure 44. Solidification flaws in a sample from ring 14 - 898. Bar equal to 100 μm .

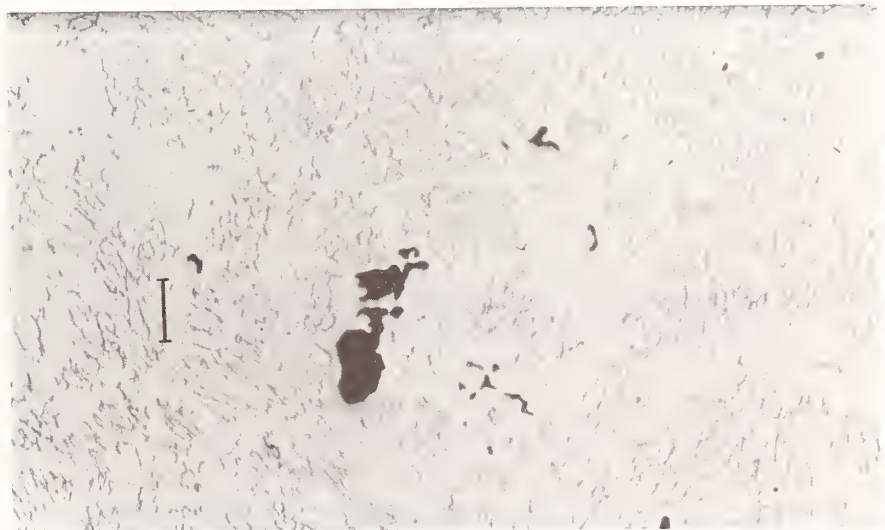

Figure 45. Solidification flaws in a sample from ring 7 - 1268. Bar equal to 100 μm .

6.5 Atomic Force Microscopy

The microstructure (by atomic force microscopy (AFM)) and the magnetic fields (by magnetic force microscopy (MFM)) for a low FN specimen and one with an FN near 42 have been evaluated. These evaluations showed that the phases delineated in light microscopy, AFM, and MFM are the same phases: Magnetic domain images show the magnetic ferritic phase is correctly and clearly revealed by light microscopy and AFM.

The characteristic microstructural features (austenite islands, bordered by ferrite) are closely spaced, as shown in Figure 46. The width of the austenitic phase separating the magnetic ferrite phase is typically less than 25 μm wide in this example. This fine structure means that many dendrites are included in each measurement by the 1 mm diameter magnet of the gage. Also, these dimensions are similar to those found in welds, indicating their suitability for use as secondary reference materials. The magnetic force image shows that the magnetic domains in the ferrite phase have characteristic dimensions near 2 or 3 μm , giving more information on the fine distribution of the magnetic fields through these specimens.

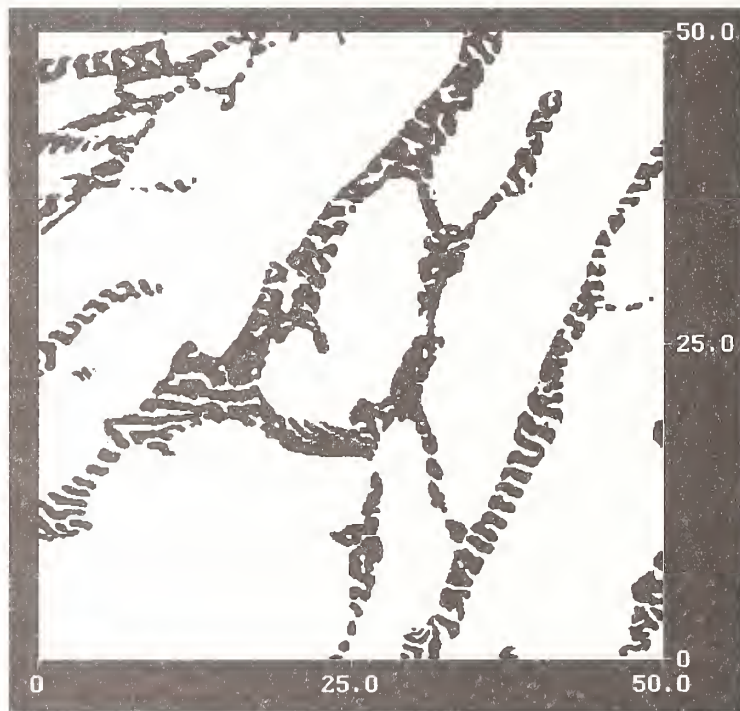

Figure 46. MFM image of the magnetic domains in a secondary FN standard sample. The larger, white regions show the morphology of the austenite phase. The black-and-white striped regions show the ferritic phase, indicating the size and orientation of magnetic domains. Units in micrometers.

7. Information on Reference Material

Twenty-five sets of secondary specimens are in inventory and can be ordered from the NIST Standard Reference Materials program by phone at (800) 975-6776, by fax at (301) 948-3730, by email at srminfo@nist.gov, or on the net at <http://ts.nist.gov/srm>. Information on the inventory can be obtained from Rob Gettings by phone at (301) 975-5573 or by email at gettings@nist.gov. Technical information can be obtained from Tom Siewert at (303) 497-3523 or siewert@nist.gov and Chris McCowan at (303) 497-3699 or mccowan@boulder.nist.gov.

8. Plans

Over the next few years, we will calibrate additional sets, so we can achieve a stock of equal numbers (50) of sets in each range. In addition to calibrating these sets as secondary reference materials according to the internationally recognized procedure (AWS A4.2, based on NIST reference materials for coating thickness), we propose to develop a primary calibration system which will be traceable to primary electrical quantities. The most likely basis for the system will be dc magnetic measurements. Initial work will determine the actual magnetic properties of the existing secondary standard materials at both the macro- and micro-magnetic levels. Conventional metallography will play a significant role in this phase of the work. Magnetic force microscopy and vibrating specimen magnetometry will be used along with superconducting quantum interference device (SQUID) magnetometry as necessary to characterize the ferrite magnetics. The ultimate goal will be the development of a portable, easily used, standard magnetic measurement device suitable for accurate determination of ferrite concentration. This standards development activity will occur parallel to the assignment of values according to the existing standard, and will be performed in close collaboration with experts in WRC, AWS, and IIW Commission II, so the users group will be ready to adopt this primary calibration technique when it is ready.

We thank D.J. Kotecki (The Lincoln Electric Company) for his comments on this manuscript and for his active role in helping us obtain the samples from Russia.

9. References

1. *Standard Procedures for Calibrating Magnetic Instruments to Measure the Delta Ferrite Content of Austenitic and Duplex Austenitic-Ferritic Stainless Steel Weld Metal*, American Welding Society Standard A4.2-91, American Welding Society, Miami, Florida, 1991.
2. B.J. Ginn, T.G. Gooch, D.J. Kotecki, G. Rabensteiner, and P. Merinov, Weld Metal Ferrite Standards Handle Calibration of Magnetic Instruments, *Welding Journal* 76:59; September 1997.
3. D.J. Kotecki, Extension of the WRC Ferrite Number System, *Welding Journal* 61: 352-s; November 1982.

Appendix A

Primary Calibration Data

Primary standards and average white-dial values (gage 1 and gage 2):

Case	THICK (mm)	FN	G1AVG	G2AVG
1		0.0	110.25	109.50
2	1.9010	2.7293	100.00	96.50
3	1.8000	2.9429	99.25	95.75
4	1.7000	3.1795	98.13	94.38
5	1.6310	3.3595	97.50	94.25
6	1.0700	5.6371	88.38	84.50
7	1.0060	6.0448	86.38	82.88
8	0.8200	7.5475	80.38	76.63
9	0.8100	7.6454	80.13	76.25
10	0.6150	10.0917	70.50	67.25
11	0.4960	12.3590	61.13	58.38
12	0.3710	15.9824	45.75	44.13
13	0.2770	20.3685	28.63	25.50
14	0.2510	22.0350	19.50	15.88
15	0.2075	25.5438	6.88	2.75
16	0.1950	26.7801	3.00	-1.50
17	0.1372	34.6713	-28.88	-34.25
18	0.0836	48.73	-78.25	-82.00
19	0.0481	69.0539	-156.25	-164.00
20	0.0478	69.3566	-154.75	-162.00
21	0.0435	73.2966	-172.25	-178.88
22	0.0376	79.7415	-191.63	-204.00
23	0.0374	79.9709	-199.38	-208.00
24	0.0345	83.6737	-211.50	-222.50
25	0.0277	94.1840	-255.50	-272.50
26	0.0135	130.2505	-372.00	-415.00

Force Calibration for Gage 2

The gram-force measurements for 0, 7, 14, 21, 25 g counterweights. Gage 2 offset for 0 to 7 g equal to 118, for 0 to 14 g equal to 236, for 0 to 21 g equal to 354, for 0 to 25 g equal to 422.

Case	WD	0	7	14	21	25
1	0.0	5.00	10.45	15.80	21.15	24.27
2	5.00	4.76	10.22	15.56	20.96	24.12
3	10.00	4.55	9.97	15.36	20.70	23.84
4	15.00	4.33	9.75	15.14	20.46	23.61
5	20.00	4.13	9.55	14.93	20.29	23.40
6	25.00	3.92	9.33	14.72	20.11	23.17
7	30.00	3.70	9.13	14.51	19.93	22.97
8	35.00	3.49	8.89	14.29	19.70	22.75
9	40.00	3.28	8.68	14.07	19.41	22.53
10	45.00	3.03	8.44	13.83	19.23	22.29
11	50.00	2.80	8.22	13.59	19.00	22.04
12	55.00	2.55	7.95	13.35	18.78	21.81
13	60.00	2.31	7.70	13.09	18.47	21.57
14	65.00	2.04	7.45	12.84	18.22	21.30
15	70.00	1.78	7.18	12.60	17.97	21.01
16	75.00	1.52	6.92	12.32	17.70	20.78
17	80.00	1.28	6.73	12.09	17.47	20.54
18	85.00	1.05	6.44	11.85	17.20	20.33
19	90.00	0.81	6.21	11.61	16.97	20.08
20	95.00	0.60	6.00	11.41	16.80	19.86
21	100.00	.	5.77	11.15	16.56	19.63
22	105.00	.	5.56	10.98	16.33	19.43
23	110.00	.	5.36	10.76	16.12	19.22
24	115.00	.	5.17	10.54	15.93	19.01
25	120.00	.	4.92	10.34	15.73	18.78
26	125.00	.	4.69	10.12	15.48	18.55
27	130.00	.	4.46	9.90	15.25	18.33
28	135.00	.	4.22	9.64	15.04	18.10
29	140.00	.	3.97	9.40	14.75	17.84
30	145.00	.	3.70	9.13	14.52	17.56
31	150.00	.	3.42	8.87	14.20	17.30

Force Calibration for Gage 1

The gram-force measurements for 0, 7, 14, 21, 25 g counterweights. The offset values determined for the various counterweights are as follows: Gage 1: offset for 0 to 7 g equal to 105, for 0 to 14 g equal to 210, for 0 to 21 g equal to 315, for 0 to 25 g equal to 375.

Case	WD	0	7	14	21	25
1	0.0	5.5	10.75	15.96	21.17	24.22
2	5.00	5.25	10.50	15.71	20.91	23.96
3	10.00	4.98	10.24	15.47	20.67	23.70
4	15.00	4.75	9.99	15.21	20.91	23.48
5	20.00	4.50	9.75	14.98	20.16	23.21
6	25.00	4.25	9.50	14.74	19.92	22.96
7	30.00	4.01	9.26	14.48	19.68	22.72
8	35.00	3.77	9.01	14.23	19.43	22.46
9	40.00	3.51	8.77	14.01	19.19	22.22
10	45.00	3.27	8.52	13.77	18.94	21.98
11	50.00	3.02	8.28	13.52	18.69	21.74
12	55.00	2.78	8.03	13.28	18.47	21.48
13	60.00	2.53	7.78	13.03	18.20	21.24
14	65.00	2.27	7.53	12.77	17.97	20.97
15	70.00	2.03	7.27	12.52	17.71	20.73
16	75.00	1.78	7.03	12.26	17.45	20.47
17	80.00	1.52	6.77	12.01	17.19	20.22
18	85.00	1.26	6.52	11.76	16.95	19.96
19	90.00	1.00	6.25	11.50	16.69	19.71
20	95.00	0.75	6.01	11.26	16.43	19.46
21	100.00	0.50	5.76	11.00	16.19	19.21
22	105.00	0.28	5.52	10.75	15.95	18.97
23	110.00	0.0	5.27	10.53	15.69	18.71
24	115.00	.	5.02	10.28	15.47	18.48
25	120.00	.	4.79	10.03	15.24	18.23
26	125.00	.	4.55	9.80	15.00	17.99
27	130.00	.	4.30	9.56	14.75	17.75
28	135.00	.	4.05	9.30	14.51	17.49
29	140.00	.	3.82	9.06	14.26	17.24
30	145.00	.	3.56	8.83	14.01	17.02
31	150.00	.	3.30	8.56	13.75	16.76

Appendix B Summary Data for the Secondary Reference Materials

- Ring = the cast ring the reference material was removed from;
 SN = the serial number (SN) of the sample;
 FNAVG = the average FN (calculated from the four averages for the operator/gage combinations);
 FN5AVG = the average FN for position 5 on the reference material;
 GMEAN = the grand average (calculated from the 20 FN measurements on the sample);
 GSD = the grand standard deviation (of the 20 measurements);
 PSD = the pooled standard deviation;
 SET = the set number that the reference material was assigned to;
 Level = the FN level that the reference material was assigned in the set.

A simple H or L set designation (without a number, H-08 for example) indicates a high-or-low level reference material that has not yet been assigned to a set. A “met” designation indicates the sample was used for metallography and will not be used as a reference material.

Case	RING	SN	FNAVG	FN5AVG	FN5SD	GMEAN	GSD	PSD	SET	LEVEL
1	3	1639	60.99	61.43	1.29	60.99	1.85	1.44	H-08	12
2	3	1640	62.93	63.09	1.88	62.93	1.63	1.19	H-11	12
3	3	1642	61.22	61.05	0.75	61.22	1.32	0.92	H-06	12
4	3	1643	62.92	62.84	1	62.92	1.27	0.83	H-02	13
5	3	1644	60.94	58.57	2.75	60.94	2.47	2.53	H	
6	7	1105	11.51	11.53	0.07	11.51	0.13	0.14	L-01	5
7	7	1117	11.17	11.27	0.15	11.17	0.15	0.12	L-04	5
8	7	1118	10.46	10.34	0.07	10.46	0.20	0.19	L-08	4
9	7	1127	11.50	11.62	0.25	11.50	0.24	0.17	L-02	5
10	7	1134	12	12.11	0.19	12	0.29	0.29	L-03	5
11	7	1135	10.29	10.37	0.08	10.29	0.13	0.11	L-05	5
12	7	1148	11.37	11.32	0.18	11.37	0.21	0.14	L	
13	7	1158	10.29	10.31	0.14	10.29	0.18	0.13	L-01	5
14	7	1164	10.52	10.52	0.10	10.52	0.25	0.24	L-06	5
15	7	1262	12.39	12.42	0.16	12.39	0.17	0.17	L	
16	7	1268	9.86	9.89	0.16	9.86	0.25	0.23	met	
17	7	1289	11.43	11.50	0.05	11.43	0.09	0.09	0.02	5
18	7	1290	11.73	11.81	0.13	11.73	0.32	0.32	L	
19	7	1515	10.87	10.77	0.28	10.87	0.23	0.22	L-07	5

Case	RING	SN	FNAVG	FN5AVG	FN5SD	GMEAN	GSD	PSD	SET	LEVEL
20	8	2074	56.92	57.13	1.09	56.92	1.69	1.67	H	
21	8	2078	62.41	61.49	1.29	62.41	1.52	0.98	H-09	12
22	8	2079	59.50	60.03	0.23	59.50	1.57	1.25	H-05	12
23	8	2080	57.12	55.58	2.53	57.12	2.57	2.20	met	
24	8	2083	57.69	56.76	0.30	57.69	1.28	1.24	H-14	12
25	10	69	32.73	32.65	0.55	32.73	0.64	0.26	H-12	9
26	10	300	31.32	31.33	0.72	31.32	0.74	0.47	H-01	9
27	10	384	33.04	33.55	0.91	33.04	0.90	0.59	H-11	9
28	10	391	32.90	32.43	0.48	32.90	0.70	0.58	H-04	9
29	10	428	32.17	32.07	1.04	32.17	1.15	0.67	H-08	9
30	10	742	35.75	35.53	0.83	35.75	0.85	0.39	H-14	10
31	10	743	36.75	36.59	0.54	36.75	0.86	0.39	H-12	10
32	10	744	35.23	35.15	0.54	35.23	0.70	0.43	H-13	9
33	10	749	35.73	35.53	0.53	35.73	0.51	0.35	0.03	10
34	10	751	34.43	34.63	0.84	34.43	0.96	0.44	H-09	9
35	10	2026	32.47	32.07	1.08	32.47	0.88	0.59	H-14	9
36	10	2027	34.03	34.12	0.64	34.03	0.88	0.70	H-05	9
37	10	2028	32.27	32.51	1.32	32.27	0.95	0.78	H-10	9
38	10	2029	34.92	33.73	1.47	34.92	1.61	1.29	met	
39	10	2030	33.48	34.64	0.47	33.48	0.95	0.87	H-07	9
40	10	2031	34.33	34.38	0.85	34.33	0.76	0.34	H-06	9
41	10	2032	30.44	31.36	1.38	30.44	1.07	0.84	H	
42	10	2033	31.32	31.82	0.64	31.32	1.25	0.94	H-02	9
43	10	2034	32.39	32.33	0.37	32.39	0.66	0.54	H-03	9
44	10	2035	33.26	33.17	0.38	33.26	0.48	0.26	0.03	9
45	11	242	51.88	52.51	2.64	51.88	2.35	2.41	met	
46	11	243	58.91	58.55	1.38	58.91	1.94	1.75	H-13	12
47	11	249	53.94	54.05	0.97	53.94	0.96	0.62	0.03	13
48	11	258	56.81	56.69	1.64	56.81	1.61	1.16	H-04	12
49	11	262	52.71	52.84	1.38	52.71	1.54	1.38	H	
50	11	271	50.22	49.65	0.56	50.22	2.48	2.54	H	
51	11	622	62.28	62.66	1.13	62.28	1.43	1.14	H-01	13
52	11	908	60.88	61.61	1.95	60.88	1.26	1.14	H-10	12
53	11	912	52.91	52.59	0.57	52.91	1.70	1.28	H-11	11
54	11	916	62.41	63.41	1.65	62.41	1.69	1.37	H-07	12
55	11	918	60.28	61.54	2.51	60.28	2.82	2.31	met	
56	11	924	62.68	63.54	1.42	62.68	1.76	1.13	H-03	13
57	12	683	52.43	52.46	0.65	52.43	0.90	0.69	H-07	11
58	12	696	52.15	52.65	1.04	52.15	1.15	0.94	H-06	11
59	12	697	52.31	51.78	3.22	52.31	2.33	2.09	met	

Case	RING	SN	FNAVg	FN5AVg	FN5SD	GMEAN	GSD	PSD	SET	LEVEL
60	12	699	53.18	52.91	0.84	53.18	0.84	0.60	H	
61	12	704	52.63	52.26	1.37	52.63	1.74	1.81	H	
62	12	706	52.34	51.62	1.21	52.34	1.74	1.30	H-05	11
63	12	709	52.16	52.39	1.24	52.16	1.90	1.93	H-10	11
64	12	712	54.35	54.11	1.76	54.35	1.51	1.45	H-13	11
65	12	713	53.63	53.35	0.98	53.63	1.31	1.05	H-01	12
66	12	714	53.97	54.05	1.02	53.97	0.99	0.49	H-02	12
67	12	717	52.56	52.72	0.29	52.56	0.98	0.90	H-12	12
68	12	718	54.94	55.80	0.50	54.94	1.37	1.28	H-03	12
69	13	536	108.09	108.64	3.35	108.09	2.19	1.38	H-12	16
70	13	540	110.25	110.99	0.73	110.25	1.92	1.47	H-14	16
71	13	542	110.50	110.91	1.60	110.50	1.85	1.31	H-10	16
72	13	549	110.38	110.45	2.65	110.38	2.04	0.83	H-08	16
73	13	552	111.20	110.65	2.11	111.20	1.98	1.06	H-09	16
74	13	556	112.19	112.55	3.05	112.19	2.21	0.71	0.03	16
75	13	557	109.55	108.57	2.38	109.55	3.55	1.87	H-02	16
76	13	558	108.72	109.23	2.16	108.72	2.16	0.89	H-03	16
77	13	559	112.19	112.44	2.57	112.19	2.24	1.34	H-06	16
78	13	562	111.06	111.91	3.04	111.06	2.53	1.15	H-05	16
79	13	563	108.56	107.88	2.36	108.38	3.34	2.29	H-01	16
80	14	446	76.12	77.64	1.51	76.12	1.77	1.76	H-01	14
81	14	866	87.38	88.92	1.84	87.38	2.44	2.07	H-01	15
82	14	867	83.24	83.73	1.42	83.24	1.93	1.44	H-05	14
83	14	868	87.13	88.66	1.96	87.13	2.10	1.79	H-11	14
84	14	871	85.95	85.52	1.99	85.95	2.33	1.88	H-06	14
85	14	873	81.52	80.96	2.10	81.52	1.90	1.57	H-03	14
86	14	875	82.62	82.38	1.73	82.62	1.92	0.75	H-12	14
87	14	882	84.06	82.15	1.05	84.06	2.25	1.87	H-14	14
88	14	883	84.26	85.06	2.35	84.26	2.20	1.10	H-09	14
89	14	885	84.29	83.97	2.55	84.29	1.96	1.21	H-08	14
90	14	887	80.26	80.59	1.75	80.26	1.92	1.30	H-02	14
91	14	888	76.88	80.13	2.96	76.88	2.49	2.60	met	
92	14	898	82.03	81.99	1.97	82.03	1.61	1.14	H-13	14
93	14	901	82.70	82.72	1.12	82.70	1.86	1.30	H-04	14
94	14	903	82.38	83.52	2.33	82.38	1.98	1.56	H-07	14
95	15	222	3.42	3.55	0.07	3.42	0.13	0.13	L-02	3
96	15	225	3.97	3.98	0.10	3.97	0.14	0.08	L-03	3
97	15	226	3.52	3.55	0.21	3.52	0.17	0.11	L-04	3
98	15	227	3.86	3.86	0.09	3.86	0.09	0.04	0.02	3
99	15	228	3.92	3.91	0.06	3.92	0.09	0.06	L-12	3

Case	RING	SN	FNAVG	FNSAVG	FNSSD	GMEAN	GSD	PSD	SET	LLEVEL
100	15	229	3.52	3.49	0	3.52	0.08	0.08	L-01	3
101	15	230	4.06	4.13	0.15	4.06	0.16	0.16	L-13	3
102	15	231	4.01	4.06	0.13	4.02	0.14	0.14	L-05	3
103	15	232	3.39	3.43	0.16	3.39	0.20	0.20	L-11	3
104	15	234	3.51	3.61	0.10	3.51	0.12	0.12	L-06	3
105	15	235	3.35	3.25	0.20	3.35	0.26	0.26	L-10	3
106	15	1374	3.21	3.34	0.20	3.21	0.17	0.17	L-07	3
107	15	1375	4.62	4.59	0.09	4.62	0.16	0.16	L-08	3
108	15	1376	4.03	4.08	0.15	4.03	0.11	0.11	L-01	3
109	15	1379	2.98	3.03	0.12	2.98	0.15	0.15	L-09	3
110	16	1002	0.70	0.71	0.14	0.70	0.12	0.12	L-02	1
111	16	1007	0.60	0.62	0.16	0.60	0.15	0.15	L-09	1
112	16	1009	0.70	0.68	0.12	0.70	0.10	0.10	L-10	1
113	16	1012	1.07	1.09	0.06	1.07	0.07	0.07	L-02	1
114	16	1013	0.90	0.88	0.24	0.90	0.18	0.18	L-01	1
115	16	1014	0.75	0.74	0.22	0.75	0.19	0.19	L-03	1
116	16	1015	0.89	0.87	0.14	0.89	0.09	0.09	L-04	1
117	16	1016	0.81	0.83	0.14	0.81	0.08	0.08	L-12	1
118	16	1018	0.80	0.80	0.09	0.80	0.10	0.10	L-05	1
119	16	1019	1	0.97	0.15	1	0.11	0.11	L-13	1
120	16	1020	1.08	1.09	0.06	1.08	0.06	0.06	L-01	1
121	16	1023	0.62	0.65	0.10	0.62	0.08	0.08	L-06	1
122	16	1024	0.78	0.82	0.11	0.78	0.09	0.09	L-07	1
123	16	1025	0.77	0.79	0.06	0.77	0.06	0.06	L-11	1
124	16	1026	1.65	1.70	0.06	1.65	0.08	0.08	L-09	2
125	17	754	2.32	2.31	0.06	2.32	0.06	0.06	L-02	2
126	17	756	2.12	2.12	0.11	2.12	0.10	0.10	L-01	2
127	17	757	2.60	2.67	0.11	2.60	0.12	0.12	L-06	2
128	17	760	2.32	2.30	0.06	2.32	0.08	0.08	L-10	2
129	17	761	2.64	2.70	0.05	2.64	0.10	0.10	L-08	2
130	17	762	2.47	2.52	0.09	2.47	0.12	0.12	L-02	2
131	17	763	2.41	2.44	0.13	2.41	0.10	0.10	L-05	2
132	17	764	2.41	2.49	0.03	2.41	0.08	0.08	L-01	2
133	17	768	2.40	2.42	0.11	2.40	0.10	0.10	L-11	2
134	17	769	2.18	2.19	0.16	2.18	0.13	0.13	L-03	2
135	17	770	2.47	2.48	0.07	2.47	0.07	0.07	L-12	2
136	17	771	2.45	2.48	0.07	2.45	0.10	0.10	L-13	2
137	17	773	1.55	1.52	0.02	1.55	0.06	0.06	L-08	1
138	17	774	2.10	2.03	0.11	2.10	0.16	0.16	L-04	2
139	17	777	2.12	2.12	0.11	2.12	0.09	0.09	L-07	2

Case	RING	SN	FNAVG	FN5AVG	FN5SD	GMEAN	GSD	PSD	SET	LEVEL
140	18	153	8.33	8.32	0.10	8.33	0.20	0.21	L-02	4
141	18	1299	9.40	9.58	0.23	9.40	0.27	0.29	0.02	4
142	18	1304	9.01	9.04	0.15	9.01	0.19	0.14	L-04	4
143	18	1305	9.23	9.53	0.11	9.23	0.31	0.33	L-05	4
144	18	1306	8.26	8.44	0.11	8.26	0.23	0.23	L-06	4
145	18	1308	9.38	9.53	0.17	9.38	0.26	0.22	L-07	4
146	18	1309	9.16	9.15	0.15	9.16	0.18	0.14	L-12	4
147	18	1311	8.05	8.11	0.18	8.05	0.23	0.18	L-09	4
148	18	1312	8.28	8.46	0.15	8.28	0.29	0.30	L-10	4
149	18	1314	9.13	9.21	0.15	9.13	0.21	0.12	L-13	4
150	18	1318	9.26	9.10	0.23	9.26	0.24	0.21	L-11	4
151	18	1329	8.67	8.57	0.11	8.67	0.25	0.25	L-03	4
152	18	1334	9.11	9.15	0.09	9.11	0.14	0.13	0.01	4
153	18	1355	8.92	8.93	0.23	8.92	0.23	0.18	L-01	4
154	19	156	14.77	14.77	0.33	14.77	0.32	0.11	L-02	6
155	19	157	13.57	13.52	0.40	13.57	0.36	0.28	L-01	6
156	19	158	15.95	16.21	0.42	15.95	0.41	0.26	L-03	6
157	19	159	14.74	14.78	0.36	14.74	0.52	0.54	L-09	5
158	19	160	15.01	15	0.31	15.01	0.32	0.17	L-11	5
159	19	161	14.58	14.68	0.10	14.58	0.35	0.37	L-04	6
160	19	162	14.74	14.54	0.18	14.74	0.24	0.24	L-05	6
161	19	163	13.83	13.90	0.15	13.83	0.25	0.24	0.02	6
162	19	164	13.76	13.59	0.16	13.76	0.33	0.32	L-06	6
163	19	166	16.08	16.15	0.18	16.08	0.25	0.25	L-07	6
164	19	168	15.51	15.52	0.14	15.51	0.34	0.33	L-13	5
165	19	170	15.38	15.46	0.29	15.38	0.20	0.10	L-12	5
166	19	172	14.80	14.96	0.13	14.80	0.18	0.18	0.01	6
167	19	670	15.59	15.69	0.26	15.59	0.23	0.14	L-08	5
168	19	1538	14.92	14.98	0.16	14.92	0.62	0.59	L-10	5
169	21	465	96.12	96.75	1.07	96.12	2.08	1.45	H-11	15
170	21	1215	95.44	95.72	1.76	95.44	2.44	1.62	H-06	15
171	21	1216	92.95	91.80	2.34	92.95	2.61	2.15	0.03	15
172	21	1221	90.10	90.51	2.43	90.10	1.97	1.57	H-02	15
173	21	1224	94.12	94.41	3.29	94.12	2.54	1.92	H-13	15
174	21	1225	95.15	95.45	2.39	95.15	2.16	1.86	H-05	15
175	21	1228	91.07	91.66	2.63	91.07	2.28	1.56	H-12	15
176	21	1230	94.57	95	1.88	94.57	2.96	2.17	H-09	15
177	21	1235	94.97	96.11	1.28	94.97	2.74	2.26	H-08	15
178	21	1238	94.46	94.55	2.05	94.46	2.23	1.05	H-10	15
179	21	1239	94.78	95.17	4.81	94.78	2.64	1.91	H-14	15

Case	RING	SN	FNAVG	FNSAVG	FNS5SD	GMEAN	GSD	PSD	SET	LEVEL
180	21	1240	96.36	95.57	3.61	96.36	3.01	1.99	H-07	15
181	21	1241	93.25	93.67	1.55	93.25	2.14	1.19	H-03	15
182	21	1242	93.33	94.05	2.01	93.33	2.61	1.58	H-04	15
183	21	1243	88.05	87.51	2.43	88.05	2.36	1.68	H-10	14
184	23	793	110.65	109.54	4.58	110.65	3.59	2.03	H-04	16
185	23	799	111.34	112.19	1.86	111.34	1.86	1.30	H-11	16
186	23	816	109.88	109.36	2	109.88	1.86	0.88	H-07	16
187	23	822	112.75	112.95	2.48	112.96	2.32	1.25	H-13	16
188	24	672	70.19	70.80	1.58	70.19	1.89	1.90	H-12	13
189	24	673	68.91	69.52	2.23	68.91	2.09	1.42	H	
190	24	682	71.21	71.65	0.85	71.21	2.29	2.11	H-14	13
191	24	1569	72.34	72.31	2.03	72.34	1.59	1.35	H-08	13
192	24	1572	73.18	72.97	0.72	73.18	1.86	1.70	H-06	13
193	24	1577	74.92	74.91	1.56	74.92	1.57	1.49	H-10	13
194	24	1581	73.57	75.03	1.97	73.57	3	2.39	met	
195	24	1585	72.41	72.84	1.21	72.41	1.37	0.83	H-05	13
196	24	1587	73.38	73.81	0.58	73.38	0.98	0.81	0.03	14
197	24	1588	71.17	70.02	1.52	71.17	1.86	1.18	H-04	13
198	24	1591	74.53	73.68	0.68	74.53	1.69	1.62	H-09	13
199	24	1618	72.30	71.95	0.78	72.30	0.87	0.73	H-13	13
200	24	1619	76.30	75.73	0.72	76.30	1.63	1.52	H-11	13
201	24	1623	72.86	71.87	2.22	72.86	1.70	1.49	H	
202	25	508	24.05	24.17	0.26	24.05	0.26	0.21	L-05	8
203	25	509	24.05	24	0.12	24.05	0.25	0.21	L-06	8
204	25	510	23.12	23.17	0.20	23.12	0.29	0.23	L-07	8
205	25	512	23.97	24.05	0.16	23.97	0.30	0.28	L-04	8
206	25	515	24.99	25.25	0.42	24.99	0.34	0.25	L-13	7
207	25	517	23.01	23.14	0.21	23.01	0.31	0.25	L-09	7
208	25	518	23.52	23.63	0.26	23.52	0.24	0.12	L-10	7
209	25	519	23.81	24.27	0.31	23.81	0.39	0.34	L-11	7
210	25	520	24.52	24.51	0.24	24.52	0.26	0.12	0.02	8
211	25	601	24.30	24.46	0.21	24.30	0.32	0.23	L-12	7
212	26	972	18.19	18.10	0.19	18.19	0.25	0.25	L-07	7
213	26	973	17.11	17.46	0.28	17.11	0.31	0.29	L-04	7
214	26	974	17.73	17.95	0.10	17.73	0.22	0.24	0.02	7
215	26	1087	17.52	17.46	0.14	17.52	0.15	0.11	L-10	6
216	26	1090	17.89	17.95	0.19	17.89	0.30	0.31	L-11	6
217	26	1652	18.06	18.16	0.48	18.06	0.38	0.15	L-03	7
218	26	1653	18.14	18.18	0.26	18.14	0.28	0.24	L-02	7
219	26	1654	15.16	15.14	0.30	15.16	0.37	0.28	L-01	7

Case	RING	SN	FNAVg	FN5AVg	FN5SD	GMEAN	GSD	PSD	SET	LEVEL
220	26	1655	19.38	19.54	0.33	19.38	0.64	0.64	L-08	6
221	26	1658	17.25	17.31	0.18	17.25	0.25	0.23	L-09	6
222	26	1659	19.23	19.34	0.32	19.23	0.26	0.14	L-13	6
223	26	1667	18.17	18.25	0.18	18.17	0.25	0.21	L-12	6
224	26	1670	18.40	18.41	0.08	18.40	0.16	0.13	L-05	7
225	26	1672	17.98	17.86	0.16	17.98	0.17	0.17	0.01	7
226	26	1675	17.79	17.80	0.17	17.79	0.22	0.22	L-06	7
227	27	1071	27.12	26.20	0.52	27.12	0.74	0.81	L-02	8
228	27	1072	25.87	26.34	0.92	25.87	0.75	0.75	L	
229	27	1073	27.58	27.45	0.77	27.58	0.56	0.46	L-01	8
230	27	1076	25.78	26.01	0.05	25.78	0.31	0.32	0.01	8
231	27	1079	25.84	26.66	0.48	25.84	0.62	0.65	L-03	8
232	27	1081	26.29	26.20	0.67	26.29	0.71	0.51	L-09	8
233	27	1083	26.45	26.55	0.28	26.45	0.45	0.43	L-10	8
234	27	1732	26.69	26.95	1.40	26.69	1.40	1.20	met	
235	27	1735	27.93	28.19	0.84	27.89	1.06	0.87	L-08	
236	27	1736	26.53	27.13	0.25	26.53	0.49	0.41	L-11	8
237	27	1742	27.38	27.93	0.51	27.37	0.79	0.92	L	
238	27	1743	25.96	26.82	1.64	25.96	1.40	1	L	
239	27	1748	27.89	28.38	0.22	27.92	0.65	0.67	L-13	8
240	27	1750	27.84	27.90	0.31	27.84	0.43	0.32	L-12	8
241	27	7078	25.23	25.24	0.57	25.23	0.53	0.39	L-08	8
242	28	1807	71.79	72.27	0.53	71.79	2.36	1.78	H-07	13
243	29	840	41.47	41.25	0.87	41.47	0.81	0.61	H-05	10
244	29	1720	39.82	40.15	0.66	39.82	0.92	0.51	H-10	10
245	29	1726	40.04	40.08	0.81	40.04	0.72	0.52	H-04	10
246	29	1802	41.36	41.69	0.88	41.36	1.28	0.98	H-12	11
247	29	1857	42.36	42.53	1.08	42.36	1.29	1.11	H	
248	29	2040	36.51	36.50	1.21	36.51	1.17	1.19	H-08	10
249	29	2042	37.28	37.27	0.58	37.28	0.66	0.52	H-11	10
250	29	2043	14.69	15.03	1.22	14.69	1.08	0.78	met	
251	29	2044	37.19	38.36	0.48	37.19	1.11	0.93	H-01	10
252	29	2045	41.75	41.50	0.35	41.75	1.19	1.14	H	
253	29	2046	38.61	38.54	1.17	38.61	0.92	0.64	H-09	10
254	29	2047	39.22	39.31	0.83	39.22	1.02	0.75	H-03	10
255	30	1823	45.25	45.41	0.40	45.25	0.81	0.79	H-14	11
256	30	1824	45.71	45.10	2.49	45.71	1.72	1.03	H	
257	30	1838	47.01	47.21	0.87	47.01	1.23	1.26	H-07	10
258	30	1843	38.89	38.61	0.62	38.89	0.79	0.58	H-02	10
259	30	1859	46.98	46.44	0.38	46.98	0.75	0.78	0.03	11

Case	RING	SN	FNAVG	FNSAVG	FNSSD	GMEAN	GSD	PSD	SET	LEVEL
260	30	1876	42.52	42.14	0.22	42.52	0.83	0.86	H-06	10
261	30	1878	45.33	44.38	1.65	45.33	1.81	1.94	met	
262	30	2051	48.31	48.41	1.55	48.31	1.29	1.13	H-08	11
263	30	2052	46.82	46.56	0.94	46.82	1.10	0.81	H-01	11
264	30	2054	45.11	45.08	1.14	45.11	1.02	0.73	H-13	10
265	30	2058	48.39	48.47	1.41	48.39	1.17	0.85	H-09	11
266	30	2059	48.01	47.71	0.88	48.01	0.83	0.71	H-02	11
267	30	2062	49.90	49.86	0.54	49.90	0.69	0.57	0.03	12
268	30	2067	49.09	49.45	0.57	49.09	0.94	0.60	H	
269	30	2069	47.53	48.45	0.89	47.53	1.45	0.98	H-04	11
270	30	2072	48.78	48.10	0.58	48.78	1	0.91	H-03	11
271	30	2073	49.45	49.60	0.72	49.45	0.95	0.63	H	

Appendix C

Raw Data for the Secondary Reference Materials

Where:

Ring = the cast ring from which the reference material was removed;

SN = the serial number of the reference material;

OPER = the operator that made the measurement;

MGAGE = the Magne-gage the measurement was made on;

FN(1-5) = the position of the measurement (position 1 through 5);

FNAVG = the average FN for the gage/operator condition;

FNSTD = the standard deviation for the gage/operator condition.

RING	SN	OPER\$	MGAGE	FN(1)	FN(2)	FN(3)	FN(4)	FN(5)	FNAVG	FNSTD
3	1639	C	1	59.36	60.66	59.88	57.01	61.44	59.67	1.69
3	1639	D	2	62.07	62.57	61.31	58.79	62.57	61.47	1.58
3	1639	D	1	60.92	60.92	59.62	58.83	59.62	59.98	0.92
3	1639	C	2	61.31	62.07	64.84	63.83	62.07	62.83	1.46
3	1640	D	2	63.83	65.60	63.83	64.84	65.85	64.79	0.95
3	1640	D	1	64.84	63.27	62.23	63.01	62.23	63.11	1.07
3	1640	C	2	62.32	63.33	61.31	60.56	62.57	62.02	1.09
3	1640	C	1	63.53	63.27	60.40	60.14	61.70	61.81	1.57
3	1642	C	1	60.14	60.66	59.62	59.62	60.40	60.09	0.47
3	1642	C	2	61.31	63.83	61.06	61.31	61.57	61.82	1.14
3	1642	D	1	59.09	60.92	60.92	60.92	60.40	60.45	0.79
3	1642	D	2	62.57	63.83	61.06	63.33	61.82	62.52	1.12
3	1643	D	2	62.57	63.58	63.08	64.84	63.83	63.58	0.85
3	1643	D	1	61.97	61.97	60.66	63.01	63.01	62.12	0.97
3	1643	C	2	64.34	64.84	64.59	64.09	63.08	64.19	0.68
3	1643	C	1	60.92	61.44	62.49	62.75	61.44	61.81	0.77
3	1644	C	1	60.92	61.97	58.83	60.66	58.83	60.24	1.38
3	1644	C	2	61.82	61.82	60.05	64.09	61.31	61.82	1.46
3	1644	D	1	64.84	64.05	58.31	61.97	59.36	61.70	2.85
3	1644	D	2	63.33	59.80	58.54	63.58	54.76	60	3.66
7	1105	C	1	11.47	11.83	11.59	11.47	11.53	11.58	0.15
7	1105	C	2	11.45	11.69	11.51	11.39	11.45	11.49	0.12
7	1105	D	1	11.47	11.59	11.47	11.22	11.53	11.46	0.14
7	1105	D	2	11.39	11.63	11.63	11.39	11.63	11.53	0.13
7	1117	D	2	11.15	11.15	11.27	11.15	11.39	11.22	0.11

RING	SN	OPER\$	MGAGE	FN(1)	FN(2)	FN(3)	FN(4)	FN(5)	FNAVG	FNSTD
7	1117	C	2	11.03	11.27	11.27	11.15	11.27	11.20	0.11
7	1117	D	1	11	10.87	11	11	11.06	10.98	0.07
7	1117	C	1	11.36	11	11.36	11.24	11.36	11.27	0.16
7	1118	D	2	10.66	10.30	10.42	10.54	10.30	10.44	0.16
7	1118	C	1	10.38	10.44	10.50	10.26	10.26	10.37	0.11
7	1118	D	1	10.38	11.12	10.75	10.50	10.38	10.63	0.31
7	1118	C	2	10.54	10.30	10.42	10.30	10.42	10.40	0.10
7	1127	C	2	11.51	11.33	11.09	11.27	11.51	11.34	0.18
7	1127	D	1	11.36	11.30	11.61	11.36	11.61	11.45	0.15
7	1127	C	1	11.98	11.73	11.61	11.73	11.98	11.81	0.17
7	1127	D	2	11.63	11.39	11.15	11.51	11.39	11.42	0.18
7	1134	C	1	11.86	11.98	12.47	11.98	12.35	12.13	0.27
7	1134	C	2	11.45	11.76	12.12	11.88	11.88	11.82	0.24
7	1134	D	1	11.79	12.10	12.10	12.47	12.10	12.11	0.24
7	1134	D	2	11.39	11.76	12.36	12	12.12	11.93	0.37
7	1135	C	2	10.24	10.48	10.42	10.30	10.42	10.37	0.10
7	1135	D	2	10.30	10.48	10.30	10.30	10.42	10.36	0.09
7	1135	D	1	10.01	10.26	10.26	10.07	10.26	10.17	0.12
7	1135	C	1	10.07	10.38	10.26	10.26	10.38	10.27	0.13
7	1148	C	2	11.15	11.15	11.27	11.39	11.21	11.23	0.10
7	1148	D	1	11.98	11.61	11.49	11.36	11.55	11.60	0.23
7	1148	C	1	11.49	11.36	11.49	11.61	11.36	11.46	0.10
7	1148	D	2	11.27	11.15	11.27	11.15	11.15	11.20	0.07
7	1158	D	1	9.95	10.13	10.13	10.38	10.26	10.17	0.16
7	1158	D	2	10.18	10.42	10.30	10.06	10.18	10.23	0.14
7	1158	C	2	10.42	10.30	10.30	10.06	10.30	10.27	0.13
7	1158	C	1	10.63	10.50	10.50	10.38	10.50	10.50	0.09
7	1164	C	1	10.63	10.38	10.38	11	10.63	10.60	0.25
7	1164	C	2	10.48	10.54	10.48	11.03	10.54	10.61	0.23
7	1164	D	1	10.38	10.13	10.13	10.63	10.38	10.33	0.21
7	1164	D	2	10.48	10.42	10.30	11.03	10.54	10.55	0.28
7	1262	D	1	12.23	12.10	12.47	12.35	12.23	12.27	0.14
7	1262	C	2	12.49	12.24	12.49	12.61	12.49	12.46	0.13
7	1262	C	1	12.23	12.23	12.59	12.72	12.59	12.47	0.23
7	1262	D	2	12.36	12.12	12.49	12.49	12.36	12.36	0.15
7	1268	C	1	9.88	9.75	9.81	9.63	10.12	9.84	0.18
7	1268	C	2	10.29	9.81	10.05	9.75	9.81	9.94	0.23
7	1268	D	1	9.32	9.75	10.12	9.39	9.75	9.67	0.32
7	1268	D	2	10.17	9.93	10.05	10.05	9.87	10.01	0.12
7	1289	C	2	11.39	11.57	11.39	11.45	11.57	11.47	0.09

RING	SN	OPER\$	MGAGE	FN(1)	FN(2)	FN(3)	FN(4)	FN(5)	FNAVg	FNSTD
7	1289	D	2	11.32	11.51	11.39	11.39	11.51	11.42	0.08
7	1289	C	1	11.59	11.47	11.41	11.35	11.47	11.46	0.09
7	1289	D	1	11.35	11.35	11.22	11.47	11.47	11.37	0.10
7	1290	D	1	12.08	11.35	11.10	11.59	11.65	11.55	0.37
7	1290	C	2	12.24	11.93	11.51	11.75	11.87	11.86	0.27
7	1290	C	1	12.20	11.83	11.35	11.83	11.96	11.83	0.31
7	1290	D	2	11.99	11.75	11.14	11.75	11.75	11.68	0.32
7	1515	C	1	10.75	10.63	10.93	11	10.87	10.84	0.15
7	1515	C	2	11.27	10.72	11.27	10.91	11.03	11.04	0.24
7	1515	D	2	11.27	10.66	11.03	10.66	10.78	10.88	0.26
7	1515	D	1	10.87	10.63	10.93	10.87	10.38	10.74	0.23
8	2074	D	1	54.92	57.01	58.31	58.05	57.01	57.06	1.34
8	2074	C	2	56.27	58.29	60.05	55.01	58.29	57.58	1.96
8	2074	C	1	53.09	57.01	57.79	55.18	55.70	55.75	1.81
8	2074	D	2	56.27	58.79	58.54	55.27	57.53	57.28	1.50
8	2078	D	2	65.09	64.59	63.58	64.34	62.32	63.99	1.08
8	2078	C	1	62.49	61.97	60.40	60.14	60.14	61.03	1.12
8	2078	C	2	63.58	63.58	62.32	63.33	62.83	63.13	0.55
8	2078	D	1	60.92	60.92	61.70	63.27	60.66	61.50	1.07
8	2079	D	1	57.53	59.09	58.83	58.83	60.14	58.89	0.93
8	2079	D	2	59.80	63.33	62.07	59.80	60.31	61.06	1.57
8	2079	C	1	58.57	57.79	57.79	57.53	59.88	58.31	0.96
8	2079	C	2	60.56	60.56	57.28	60.56	59.80	59.75	1.42
8	2080	D	2	59.80	57.28	59.80	60.31	59.30	59.30	1.18
8	2080	D	1	59.09	55.70	52.83	58.31	54.14	56.01	2.67
8	2080	C	2	61.31	55.77	57.28	59.80	55.01	57.84	2.67
8	2080	C	1	58.05	54.92	53.35	56.48	53.87	55.34	1.93
8	2083	C	2	56.53	58.29	59.55	60.31	57.03	58.34	1.61
8	2083	D	1	57.01	56.75	58.83	58.31	56.48	57.48	1.03
8	2083	D	2	58.04	57.53	58.29	60.05	56.53	58.09	1.29
8	2083	C	1	55.70	57.27	56.22	58.05	57.01	56.85	0.92
10	69	D	2	33.22	33.34	33.34	33.09	33.22	33.22	0.13
10	69	C	1	32.21	32.73	32.21	32.73	31.95	32.37	0.35
10	69	C	2	33.34	33.34	33.47	33.59	33.09	33.37	0.19
10	69	D	1	31.95	31.95	31.56	31.95	32.47	31.98	0.32
10	300	C	2	31.83	31.96	31.33	32.33	31.96	31.88	0.36
10	300	D	1	31.04	30.25	30.12	30.51	30.38	30.46	0.35
10	300	C	1	31.43	30.38	30.51	31.95	31.17	31.09	0.65
10	300	D	2	31.58	31.58	31.58	32.59	31.83	31.83	0.44
10	384	C	1	32.47	31.69	32.47	31.69	32.73	32.21	0.49

RING	SN	OPERS	MGAGE	FN(1)	FN(2)	FN(3)	FN(4)	FN(5)	FNAVG	FNSTD
10	384	C	2	33.59	34.22	32.84	33.34	34.85	33.77	0.78
10	384	D	1	32.47	31.69	32.47	32.47	33.26	32.47	0.55
10	384	D	2	33.85	34.10	34.10	33.09	33.34	33.69	0.46
10	391	C	1	32.21	33.78	32.73	32.21	31.95	32.58	0.73
10	391	C	2	34.10	33.59	33.59	33.09	32.84	33.44	0.49
10	391	D	2	34.10	32.84	32.84	33.47	32.84	33.22	0.56
10	391	D	1	32.21	33.26	32.34	31.95	32.08	32.37	0.52
10	428	D	1	30.38	30.78	31.30	31.95	31.17	31.11	0.59
10	428	C	1	30.91	31.17	32.21	31.17	31.17	31.32	0.51
10	428	C	2	32.33	34.10	32.59	33.34	33.09	33.09	0.69
10	428	D	2	31.83	33.85	33.85	33.34	32.84	33.14	0.84
10	742	D	1	35.34	34.82	35.60	35.08	34.82	35.13	0.34
10	742	C	2	35.99	36.37	37.12	36.62	36.11	36.44	0.45
10	742	C	1	35.08	34.56	35.08	34.82	34.82	34.87	0.22
10	742	D	2	36.11	36.37	37.37	36.62	36.37	36.57	0.48
10	743	C	1	35.08	35.08	36.39	35.87	36.13	35.71	0.60
10	743	C	2	37.88	37.37	37.88	37.63	37.12	37.58	0.33
10	743	D	1	36.65	36.13	36.39	36.39	36.13	36.33	0.22
10	743	D	2	37.75	37.12	37.63	37.37	37	37.37	0.32
10	744	C	1	34.82	35.34	34.82	34.82	34.82	34.93	0.23
10	744	C	2	35.86	36.24	35.61	35.36	35.61	35.74	0.33
10	744	D	1	34.04	35.08	34.56	34.04	34.56	34.46	0.44
10	744	D	2	35.11	36.49	36.37	35.36	35.61	35.79	0.61
10	749	D	2	35.99	35.99	35.61	35.86	36.11	35.91	0.19
10	749	D	1	35.60	35.60	35.87	35.08	35.08	35.45	0.35
10	749	C	2	36.62	36.62	36.11	36.11	35.86	36.27	0.34
10	749	C	1	35.08	36.13	35.08	35.08	35.08	35.29	0.47
10	751	C	1	33.26	32.99	33.26	33.39	34.04	33.39	0.39
10	751	C	2	35.36	36.11	34.60	35.61	35.36	35.41	0.55
10	751	D	1	33.78	33.91	33.26	34.30	33.78	33.80	0.37
10	751	D	2	34.35	35.11	35.36	35.36	35.36	35.11	0.44
10	2026	D	2	33.34	32.33	33.09	33.72	33.34	33.17	0.52
10	2026	D	1	32.47	32.21	32.47	32.73	31.17	32.21	0.61
10	2026	C	2	32.08	32.84	34.10	33.59	32.59	33.04	0.80
10	2026	C	1	31.69	31.69	31.69	31.17	31.17	31.48	0.29
10	2027	C	1	33.52	34.04	32.99	34.30	34.04	33.78	0.52
10	2027	C	2	34.60	34.60	35.11	33.09	34.60	34.40	0.76
10	2027	D	1	32.21	34.30	32.47	33.78	33.26	33.20	0.87
10	2027	D	2	33.85	34.85	35.11	35.36	34.60	34.75	0.58
10	2028	C	2	32.59	31.83	32.84	34.10	33.59	32.99	0.88

RING	SN	OPER\$	MGAGE	FN(1)	FN(2)	FN(3)	FN(4)	FN(5)	FNAVG	FNSTD
10	2028	C	1	31.43	30.51	32.34	32.47	30.91	31.53	0.86
10	2028	D	1	31.69	30.91	31.95	32.47	31.95	31.79	0.57
10	2028	D	2	32.71	31.58	32.84	33.09	33.59	32.76	0.74
10	2029	D	2	35.86	34.60	35.36	35.11	34.85	35.16	0.48
10	2029	D	1	34.82	33.52	36.13	33.52	32.21	34.04	1.49
10	2029	C	1	34.04	31.69	36.13	35.08	32.73	33.93	1.78
10	2029	C	2	36.37	37.12	37.88	36.37	35.11	36.57	1.03
10	2030	D	2	33.34	34.10	34.35	33.85	35.11	34.15	0.65
10	2030	C	2	33.34	33.59	34.35	32.59	34.98	33.77	0.92
10	2030	C	1	33.52	31.95	33.26	31.95	34.17	32.97	0.99
10	2030	D	1	31.95	32.73	33.52	32.73	34.30	33.05	0.89
10	2031	C	1	33.26	33.52	33.78	33.26	33.78	33.52	0.26
10	2031	C	2	35.11	35.61	34.60	35.11	35.11	35.11	0.36
10	2031	D	1	33.52	34.56	33.78	33.78	33.52	33.83	0.43
10	2031	D	2	34.35	34.85	34.85	35.11	35.11	34.85	0.31
10	2032	D	1							
10	2032	C	2	31.58	30.32	30.32	31.07	32.33	31.12	0.86
10	2032	C	1	29.60	29.60	28.56	30.64	30.38	29.76	0.82
10	2032	D	2							
10	2033	D	2	32.71	31.58	30.32	32.59	32.08	31.86	0.97
10	2033	D	1	31.69	31.43	30.12	31.69	31.43	31.27	0.66
10	2033	C	2	32.59	32.59	31.07	32.33	32.59	32.23	0.66
10	2033	C	1	28.82	28.56	29.60	31.43	31.17	29.91	1.32
10	2034	D	1	32.21	31.95	31.43	32.73	31.95	32.05	0.47
10	2034	C	2	33.59	33.34	32.33	33.09	32.33	32.94	0.58
10	2034	C	1	31.95	32.08	31.17	32.08	32.21	31.90	0.42
10	2034	D	2	33.34	32.84	31.58	32.84	32.84	32.69	0.66
10	2035	D	2	33.59	33.72	33.59	33.59	33.34	33.57	0.14
10	2035	C	1	32.99	32.73	32.73	33.26	32.99	32.94	0.22
10	2035	C	2	33.59	34.10	33.85	33.59	33.59	33.75	0.23
10	2035	D	1	32.21	32.73	32.99	33.26	32.73	32.79	0.39
11	242	C	1	48.65	55.18	53.09	47.87	49.70	50.90	3.11
11	242	C	2	50.48	56.78	53.25	50.48	51.74	52.54	2.63
11	242	D	1	48.92	52.57	52.57	49.96	52.57	51.32	1.75
11	242	D	2	51.23	51.99	52.49	51.99	56.02	52.75	1.89
11	243	D	2	63.83	61.31	61.31	56.27	60.56	60.66	2.75
11	243	D	1	59.36	58.31	58.31	57.01	58.31	58.26	0.83

* Measurement incomplete, specimen not distributed

RING	SN	OPER\$	MGAGE	FN(1)	FN(2)	FN(3)	FN(4)	FN(5)	FNAVG	FNSTD
11	243	C	2	58.79	60.05	61.31	56.53	57.53	58.84	1.91
11	243	C	1	57.79	57.27	58.83	57.79	57.79	57.89	0.57
11	249	C	1	52.31	53.09	52.83	54.40	53.09	53.14	0.77
11	249	C	2	54.26	54.01	55.52	55.27	55.01	54.81	0.65
11	249	D	2	54.26	55.01	53.75	55.01	54.76	54.56	0.55
11	249	D	1	52.57	53.87	53.09	53.35	53.35	53.25	0.47
11	258	C	1	55.70	56.22	55.70	54.40	54.92	55.39	0.72
11	258	C	2	58.04	59.05	57.03	55.52	56.02	57.13	1.44
11	258	D	1	55.96	56.22	55.44	56.22	57.01	56.17	0.57
11	258	D	2	57.28	61.06	57.28	58.29	58.79	58.54	1.55
11	262	D	1	51.53	52.31	54.92	52.83	52.31	52.78	1.28
11	262	C	1	50.48	50.22	51.79	52.83	51.53	51.37	1.05
11	262	C	2	52.75	51.99	53	56.02	54.76	53.70	1.65
11	262	D	2	52.75	51.74	55.52	52.24	52.75	53	1.47
11	271	D	2	48.97	53.50	52.49	49.22	48.97	50.63	2.19
11	271	D	1	47.09	51	50.48	47.35	50.22	49.23	1.86
11	271	C	2	48.21	54.26	54.76	49.47	49.97	51.33	2.97
11	271	C	1	46.57	52.83	52.57	47.09	49.44	49.70	2.95
11	622	C	1	60.14	60.40	63.01	60.14	61.97	61.13	1.30
11	622	C	2	62.83	63.58	60.56	62.32	61.57	62.17	1.16
11	622	D	1	61.70	61.44	63.01	60.92	63.01	62.02	0.95
11	622	D	2	62.07	64.59	64.84	63.33	64.09	63.78	1.12
11	908	C	1	59.88	60.40	59.62	59.62	60.66	60.03	0.47
11	908	C	2	62.07	59.80	59.55	60.05	62.83	60.86	1.48
11	908	D	1	60.40	61.97	61.18	60.66	59.36	60.71	0.97
11	908	D	2	61.82	59.80	62.32	62.07	63.58	61.92	1.36
11	912	C	1	52.05	51.53	51.26	47.87	51.79	50.90	1.72
11	912	C	2	54.76	53.75	54.26	53.75	53	53.91	0.66
11	912	D	1	51.79	53.35	55.18	52.83	52.57	53.14	1.27
11	912	D	2	55.52	54.26	52.24	53.50	53	53.70	1.25
11	916	C	1	59.36	60.92	60.40	60.92	62.75	60.87	1.23
11	916	D	1	60.66	63.27	60.66	63.01	61.70	61.86	1.25
11	916	D	2	63.08	62.83	62.83	64.59	63.58	63.38	0.74
11	916	C	2	60.81	63.08	62.83	65.35	65.60	63.53	1.98
11	918	D	1	55.18	56.22	61.70	61.44	58.31	58.57	2.96
11	918	C	1	57.53	57.53	57.79	58.31	60.92	58.42	1.44
11	918	C	2	61.57	60.81	64.09	57.53	64.09	61.62	2.72
11	918	D	2	60.56	61.06	64.84	63.33	62.83	62.52	1.74
11	924	C	1	61.18	61.70	60.66	61.70	62.75	61.60	0.77
11	924	C	2	64.34	61.31	63.08	62.07	63.33	62.83	1.17

RING	SN	OPER\$	MGAGE	FN(1)	FN(2)	FN(3)	FN(4)	FN(5)	FNAVG	FNSTD
11	924	D	1	60.40	60.40	60.66	63.01	62.49	61.39	1.26
11	924	D	2	63.08	66.35	64.34	65.09	65.60	64.89	1.25
12	683	D	2	53	53.25	53	53.50	52.75	53.10	0.29
12	683	D	1	51.26	49.96	51.53	53.09	52.57	51.68	1.22
12	683	C	2	52.75	52.75	53.50	53	53	53	0.31
12	683	C	1	51.79	51.53	52.57	52.31	51.53	51.94	0.47
12	696	C	2	52.75	52.75	51.23	53	54.01	52.75	0.99
12	696	D	1	51.79	52.83	51.79	50.74	52.31	51.89	0.77
12	696	D	2	52.75	53.25	52.49	53.25	52.75	52.90	0.34
12	696	C	1	51.79	51.79	48.65	51.53	51.53	51.06	1.35
12	697	C	1	48.92	53.35	52.31	54.14	48.92	51.53	2.47
12	697	C	2	53.25	55.77	55.01	53.25	55.27	54.51	1.18
12	697	D	1	50.22	54.14	51.79	51.26	49.18	51.32	1.87
12	697	D	2	49.22	53.75	53.75	48.97	53.75	51.89	2.56
12	699	C	2	53.75	53.25	53.75	52.75	53.25	53.35	0.42
12	699	D	2	54.76	54.76	53.75	53.25	53.75	54.06	0.68
12	699	D	1	53.35	53.35	53.35	51.79	52.83	52.93	0.68
12	699	C	1	52.31	52.83	53.09	51.79	51.79	52.36	0.60
12	704	D	1	52.31	53.87	53.09	51.79	51.79	52.57	0.90
12	704	D	2	51.49	54.26	54.01	49.47	54.01	52.65	2.11
12	704	C	2	51.99	55.27	56.27	50.73	52.49	53.35	2.33
12	704	C	1	51.79	51	54.66	51.53	50.74	51.94	1.57
12	706	D	2	52.49	54.51	55.77	53	52.75	53.70	1.40
12	706	D	1	50.74	53.35	54.92	53.87	51	52.78	1.83
12	706	C	2	51.74	52.24	51.74	54.51	52.49	52.54	1.15
12	706	C	1	50.74	49.70	50.61	50.48	50.22	50.35	0.41
12	709	C	1	50.74	50.48	52.83	54.14	52.57	52.15	1.53
12	709	D	1	48.65	48.65	53.61	54.14	50.74	51.16	2.63
12	709	D	2	51.49	49.97	54.26	53.25	52.49	52.29	1.65
12	709	C	2	51.49	50.98	54.01	55.01	53.75	53.05	1.73
12	712	C	1	53.09	53.87	53.87	52.83	53.61	53.46	0.47
12	712	C	2	53.75	56.27	54.76	54.76	56.53	55.22	1.16
12	712	D	1	51.53	56.22	54.40	55.18	52.31	53.93	1.97
12	712	D	2	54.51	56.78	56.27	52.49	54.01	54.81	1.74
12	713	C	1	51.26	52.83	52.05	54.66	52.31	52.62	1.27
12	713	D	2	53	56.02	52.49	54.01	54.51	54.01	1.38
12	713	D	1	53.09	52.83	53.09	53.35	52.83	53.04	0.22
12	713	C	2	56.02	55.52	54.26	54.76	53.75	54.86	0.92
12	714	D	1	52.57	53.61	53.09	53.87	53.61	53.35	0.52
12	714	D	2	53.75	54.01	55.01	54.26	54.76	54.36	0.52

RING	SN	OPERS	MGAGE	FN(1)	FN(2)	FN(3)	FN(4)	FN(5)	FNAVG	FNSTD
12	714	C	1	53.35	53.09	53.35	52.31	52.83	52.99	0.44
12	714	C	2	55.01	55.01	56.02	54.76	55.01	55.17	0.49
12	717	C	1	53.22	51.73	52.44	50.48	52.31	52.04	1.02
12	717	C	2	53.50	53.75	51.49	53.75	52.75	53.05	0.97
12	717	D	1	52.31	52.05	50.48	52.57	52.83	52.05	0.92
12	717	D	2	53	54.01	52.24	53.25	53	53.10	0.63
12	718	D	2	52.75	56.53	57.03	56.78	56.53	55.92	1.79
12	718	C	1	53.61	53.61	53.35	54.66	55.44	54.14	0.89
12	718	C	2	54.76	55.52	56.02	54.26	55.52	55.22	0.70
12	718	D	1	52.31	55.96	54.14	54.40	55.70	54.50	1.46
13	536	C	2	109.45	107.43	111.21	106.17	110.96	109.04	2.20
13	536	C	1	106.60	106.60	106.60	107.38	106.60	106.75	0.35
13	536	D	1	106.34	106.60	106.34	106.34	105.03	106.13	0.62
13	536	D	2	108.44	109.45	111.71	110.71	111.97	110.45	1.50
13	540	D	2	113.73	110.45	113.73	111.21	110.96	112.02	1.59
13	540	D	1	107.90	106.86	106.86	109.73	109.99	108.27	1.52
13	540	C	1	109.47	109.21	109.99	111.29	111.29	110.25	0.99
13	540	C	2	112.47	109.95	108.19	109.95	111.71	110.45	1.68
13	542	D	2	110.45	112.22	111.97	111.71	110.71	111.41	0.78
13	542	D	1	109.21	105.29	108.42	109.21	109.99	108.42	1.84
13	542	C	2	111.71	111.46	111.97	111.71	113.23	112.02	0.70
13	542	C	1	108.68	112.60	109.21	110.51	109.73	110.15	1.53
13	549	C	2	112.47	113.48	112.72	112.47	113.48	112.92	0.52
13	549	D	2	112.47	112.22	110.20	109.95	111.21	111.21	1.14
13	549	D	1	107.12	109.21	108.42	108.42	107.12	108.06	0.92
13	549	C	1	109.47	109.47	109.21	108.42	109.99	109.31	0.57
13	552	D	1	107.90	108.94	108.94	108.94	108.94	108.74	0.47
13	552	C	2	111.97	111.21	113.23	113.23	109.95	111.92	1.40
13	552	C	1	111.29	110.77	110.51	111.56	109.99	110.82	0.62
13	552	D	2	113.73	112.97	114.99	111.21	113.73	113.33	1.39
13	556	D	2	114.49	115.24	114.74	114.23	114.99	114.74	0.40
13	556	D	1	109.99	109.21	109.99	109.21	108.68	109.41	0.57
13	556	C	1	109.73	111.56	111.03	111.82	111.56	111.14	0.84
13	556	C	2	113.23	113.48	112.47	113.23	114.99	113.48	0.93
13	557	C	2	114.74	110.71	114.99	116.25	111.21	113.58	2.47
13	557	D	1	108.42	103.99	107.64	105.29	106.60	106.39	1.78
13	557	C	1	107.90	108.16	110.51	108.94	107.90	108.68	1.11
13	557	D	2	110.35	107.62	111.05	110.16	108.57	109.55	1.79
13	558	C	1	107.38	107.38	107.38	107.12	107.38	107.33	0.12
13	558	D	1	106.60	106.60	105.81	104.77	107.64	106.28	1.07

RING	SN	OPERS	MGAGE	FN(1)	FN(2)	FN(3)	FN(4)	FN(5)	FNAVG	FNSTD
13	558	D	2	108.69	111.97	110.45	110.45	111.97	110.71	1.36
13	558	C	2	110.71	110.96	110.45	110.71	109.95	110.55	0.38
13	559	C	1	110.25	111.56	110.51	108.68	109.73	110.15	1.05
13	559	D	1	110.25	110.51	111.82	109.21	111.29	110.62	1
13	559	D	2	113.73	114.23	116	111.97	112.97	113.78	1.51
13	559	C	2	112.47	116.25	113.48	113.23	115.75	114.23	1.66
13	562	C	1	108.42	108.68	109.73	110.25	109.47	109.31	0.75
13	562	D	1	110.96	111.21	113.23	112.47	113.73	112.32	1.23
13	562	D	2	110.25	109.47	107.38	106.34	109.21	108.53	1.62
13	562	C	2	113.73	114.49	113.23	113.73	115.24	114.08	0.79
13	563	C	2	112.47	110.71	112.47	112.47	.	112.03	0.88
13	563	C	1	107.90	105.81	105.55	105.81	107.38	106.49	1.07
13	563	D	2	102.39	112.22	111.71	112.97	110.45	109.95	4.32
13	563	D	1	105.81	105.29	106.60	105.29	105.81	105.76	0.53
14	446	C	1	73.97	75.01	76.84	77.36	75.54	75.75	1.37
14	446	C	2	75.68	75.93	76.43	76.94	78.95	76.79	1.30
14	446	D	1	73.97	73.19	75.80	75.01	77.62	75.12	1.72
14	446	D	2	77.19	78.45	72.65	77.44	78.45	76.84	2.41
14	866	D	2	88.53	88.78	86.01	92.31	91.05	89.34	2.44
14	866	D	1	84.93	85.19	84.41	84.67	87.80	85.40	1.37
14	866	C	2	89.54	90.29	86.51	84.75	89.79	88.18	2.42
14	866	C	1	86.24	87.80	88.33	83.63	87.02	86.60	1.84
14	867	C	1	79.45	84.93	80.50	81.54	82.06	81.70	2.07
14	867	C	2	82.73	85.25	81.47	83.99	84.50	83.59	1.50
14	867	D	1	82.32	81.80	82.06	82.58	83.11	82.38	0.50
14	867	D	2	86.51	86.51	84.50	83.74	85.25	85.30	1.23
14	868	D	2	90.29	88.03	87.02	85.51	90.80	88.33	2.22
14	868	D	1	86.76	86.24	85.45	85.45	86.24	86.03	0.57
14	868	C	2	90.29	89.79	86.77	86.01	89.54	88.48	1.95
14	868	C	1	87.02	85.72	83.89	83.63	88.06	85.66	1.93
14	871	D	2	84.50	87.27	86.77	91.05	87.02	87.32	2.36
14	871	D	1	87.28	83.11	84.15	85.19	83.11	84.57	1.75
14	871	C	2	88.03	87.27	87.52	88.03	87.27	87.62	0.38
14	871	C	1	82.32	85.19	81.80	87.54	84.67	84.31	2.32
14	873	C	1	83.89	78.93	81.54	78.93	78.41	80.34	2.33
14	873	C	2	83.99	81.98	82.73	82.73	81.98	82.68	0.82
14	873	D	1	82.58	78.15	80.23	80.23	80.23	80.29	1.57
14	873	D	2	83.74	81.98	83.74	81.22	83.24	82.78	1.13
14	875	D	2	85.25	83.74	83.99	83.99	83.74	84.15	0.63
14	875	D	1	79.97	80.23	80.23	80.23	80.76	80.29	0.29

RING	SN	OPERS	MGAGE	FN(1)	FN(2)	FN(3)	FN(4)	FN(5)	FNAVG	FNSTD
14	875	C	2	84.75	85	84.50	83.99	83.99	84.45	0.45
14	875	C	1	81.54	83.63	81.54	80.23	81.02	81.59	1.26
14	882	C	2	87.02	88.03	88.03	84.75	83.24	86.21	2.13
14	882	C	1	81.80	84.93	83.11	83.11	81.28	82.84	1.42
14	882	D	1	83.11	84.93	81.28	81.54	82.84	82.74	1.46
14	882	D	2	83.99	83.74	86.26	87.02	81.22	84.45	2.29
14	883	C	1	82.32	82.06	81.54	83.37	83.37	82.53	0.81
14	883	C	2	86.51	87.02	88.03	86.51	87.77	87.17	0.70
14	883	D	2	85	83.24	86.51	82.73	86.26	84.75	1.72
14	883	D	1	83.89	81.80	82.58	81.80	82.84	82.58	0.87
14	885	D	1	84.15	84.67	83.11	82.58	83.63	83.63	0.83
14	885	D	2	87.52	87.02	85.25	83.49	85.76	85.81	1.59
14	885	C	2	87.52	85.25	86.01	83.74	86.01	85.71	1.37
14	885	C	1	82.32	82.06	82.58	82.58	80.50	82.01	0.87
14	887	D	2	82.23	82.23	82.48	80.21	81.98	81.83	0.92
14	887	D	1	77.62	77.89	80.50	77.89	80.50	78.88	1.48
14	887	C	2	80.97	81.73	80.21	83.49	81.73	81.63	1.22
14	887	C	1	78.67	76.58	79.71	80.50	78.15	78.72	1.50
14	888	C	1	76.32	74.49	75.28	75.01	81.28	76.48	2.77
14	888	D	1	77.36	75.28	74.75	77.89	75.80	76.22	1.35
14	888	D	2	77.95	75.17	74.17	80.21	82.48	78	3.45
14	888	C	2	76.18	75.68	76.43	74.92	80.97	76.84	2.38
14	898	C	1	80.50	79.19	79.45	82.58	79.45	80.23	1.41
14	898	C	2	84.25	83.49	81.98	83.49	82.99	83.24	0.84
14	898	D	1	81.54	81.54	81.80	81.80	81.54	81.64	0.14
14	898	D	2	81.47	82.23	81.98	85.25	83.99	82.99	1.58
14	901	D	2	85.76	83.74	84.50	83.99	84.25	84.45	0.78
14	901	C	1	81.28	79.19	83.11	82.84	82.84	81.85	1.65
14	901	C	2	83.99	82.73	83.99	85.25	81.98	83.59	1.27
14	901	D	1	80.76	79.19	80.23	82.58	81.80	80.91	1.33
14	903	C	1	79.45	82.32	80.50	80.50	81.54	80.86	1.10
14	903	C	2	82.48	83.49	85.25	80.97	85	83.44	1.79
14	903	D	1	80.23	80.23	82.58	81.80	81.54	81.28	1.03
14	903	D	2	82.73	85.25	84.75	80.97	86.01	83.94	2.06
15	222	D	2	3.49	3.37	3.37	3.49	3.62	3.47	0.10
15	222	C	1	3.49	3.25	3.25	3.43	3.49	3.38	0.13
15	222	D	1	3.25	3.25	3.49	3.37	3.49	3.37	0.12
15	222	C	2	3.62	3.37	3.25	3.49	3.62	3.47	0.16
15	225	D	2	3.86	3.98	3.86	3.98	3.98	3.93	0.07
15	225	D	1	3.74	3.74	3.98	3.74	3.86	3.81	0.11

RING	SN	OPER\$	MGAGE	FN(1)	FN(2)	FN(3)	FN(4)	FN(5)	FNAVG	FNSTD
15	225	C	2	4.10	3.98	4.10	4.04	3.98	4.04	0.06
15	225	C	1	4.11	3.98	4.11	4.23	4.11	4.11	0.09
15	226	D	2	3.62	3.49	3.37	3.49	3.49	3.49	0.09
15	226	C	1	3.74	3.74	3.61	3.74	3.86	3.74	0.09
15	226	D	1	3.49	3.49	3.25	3.25	3.37	3.37	0.12
15	226	C	2	3.62	3.49	3.25	3.62	3.49	3.49	0.15
15	227	C	2	3.97	3.97	3.91	3.97	3.97	3.96	0.03
15	227	D	2	3.97	3.85	3.85	3.91	3.85	3.89	0.05
15	227	D	1	3.75	3.75	3.75	3.75	3.75	3.75	0.0
15	227	C	1	3.87	3.87	3.75	3.87	3.87	3.85	0.05
15	228	D	2	3.74	3.86	3.86	3.86	3.86	3.83	0.05
15	228	D	1	3.98	3.98	3.86	3.86	3.92	3.92	0.06
15	228	C	2	3.86	3.92	3.98	3.98	3.86	3.92	0.06
15	228	C	1	3.98	3.98	4.05	4.11	3.98	4.02	0.06
15	229	C	2	3.62	3.68	3.49	3.43	3.49	3.54	0.10
15	229	D	1	3.49	3.43	3.49	3.49	3.49	3.48	0.03
15	229	D	2	3.62	3.62	3.62	3.37	3.49	3.54	0.11
15	229	C	1	3.49	3.55	3.49	3.49	3.49	3.50	0.03
15	230	D	2	3.98	4.16	4.10	4.16	4.10	4.10	0.07
15	230	D	1	3.86	3.86	3.86	3.98	3.98	3.91	0.07
15	230	C	1	3.74	3.98	3.98	4.11	4.11	3.98	0.15
15	230	C	2	4.22	4.22	4.22	4.22	4.34	4.25	0.05
15	231	C	2	4.22	4.22	3.98	4.22	4.22	4.17	0.11
15	231	C	1	3.98	3.98	3.74	3.98	3.98	3.93	0.11
15	231	D	1	3.98	3.86	3.86	3.86	3.92	3.90	0.06
15	231	D	2	4.10	4.10	3.86	4.10	4.10	4.05	0.11
15	232	C	1	3.25	3.12	3.18	3.18	3.25	3.20	0.05
15	232	D	1	3.37	3	3.25	3.37	3.27	3.27	0.16
15	232	D	2	3.62	3.62	3.49	3.49	3.49	3.54	0.07
15	232	C	2	3.74	3.62	3.25	3.49	3.62	3.54	0.18
15	234	D	2	3.37	3.49	3.49	3.62	3.62	3.52	0.10
15	234	D	1	3.37	3.37	3.37	3.37	3.49	3.39	0.06
15	234	C	2	3.37	3.62	3.62	3.74	3.74	3.62	0.15
15	234	C	1	3.49	3.49	3.49	3.49	3.61	3.52	0.06
15	235	C	1	3.37	3.61	3	3.49	3.25	3.34	0.24
15	235	D	2	3.37	3.25	3.01	3.86	3.49	3.40	0.31
15	235	C	2	3.62	3.49	3.13	3.80	3.25	3.46	0.27
15	235	D	1	3.37	3.25	3	3.37	3	3.20	0.19
15	1374	C	1	3.18	3.25	3.12	3.25	3.37	3.23	0.09
15	1374	C	2	3.31	3.25	3.37	3.43	3.62	3.40	0.14

RING	SN	OPERS	MGAGE	FN(1)	FN(2)	FN(3)	FN(4)	FN(5)	FNAVG	FNSTD
15	1374	D	2	3.13	3.13	3.25	3.25	3.19	3.19	0.06
15	1374	D	1	2.88	2.88	3.12	3.12	3.18	3.04	0.15
15	1375	D	2	4.82	4.58	4.89	4.58	4.70	4.72	0.14
15	1375	D	1	4.36	4.36	4.73	4.48	4.48	4.49	0.15
15	1375	C	2	4.70	4.58	4.89	4.58	4.58	4.67	0.13
15	1375	C	1	4.61	4.48	4.85	4.61	4.61	4.63	0.13
15	1376	D	2	3.97	4.10	4.10	4.10	4.10	4.07	0.05
15	1376	C	1	4	4	4	4.06	4.12	4.03	0.05
15	1376	C	2	4.10	4.16	4.10	4.10	4.22	4.13	0.05
15	1376	D	1	3.87	3.87	3.87	3.87	3.87	3.87	0.0
15	1379	C	1	3.25	3	2.75	3	3.12	3.02	0.18
15	1379	D	2	3.13	3.13	2.77	3.01	3.13	3.03	0.16
15	1379	D	1	3	2.88	2.75	2.88	2.88	2.88	0.09
15	1379	C	2	3.19	3.01	2.77	3.01	3.01	3	0.15
16	1002	C	1	0.79	0.85	0.91	0.79	0.91	0.85	0.06
16	1002	D	2	0.58	0.58	0.70	0.58	0.70	0.63	0.07
16	1002	C	2	0.58	0.70	0.58	0.58	0.58	0.60	0.05
16	1002	D	1	0.79	0.79	0.79	0.66	0.66	0.74	0.07
16	1007	D	1	0.66	0.66	0.60	0.66	0.72	0.66	0.04
16	1007	D	2	0.46	0.46	0.46	0.46	0.46	0.46	0.0
16	1007	C	1	0.79	0.79	0.79	0.85	0.79	0.80	0.03
16	1007	C	2	0.52	0.46	0.46	0.46	0.52	0.48	0.03
16	1009	D	2	0.70	0.58	0.58	0.58	0.58	0.60	0.05
16	1009	D	1	0.79	0.79	0.79	0.79	0.79	0.79	0.0
16	1009	C	1	0.79	0.79	0.79	0.79	0.79	0.79	0.0
16	1009	C	2	0.58	0.58	0.70	0.70	0.58	0.63	0.07
16	1012	C	1	1.05	1.18	1.05	1.18	1.18	1.13	0.07
16	1012	D	2	0.94	1.06	0.94	1.06	1.06	1.01	0.07
16	1012	C	2	1.06	1.06	1.06	1.06	1.06	1.06	0.0
16	1012	D	1	1.18	1.05	1.18	1.05	1.05	1.10	0.07
16	1013	D	1	0.91	0.97	0.97	0.97	0.97	0.96	0.03
16	1013	D	2	0.82	0.82	0.82	0.82	0.82	0.82	0.0
16	1013	C	2	0.70	0.58	0.82	0.76	0.58	0.69	0.11
16	1013	C	1	1.03	1.16	1.16	1.16	1.16	1.13	0.06
16	1014	D	1	0.79	0.79	0.79	0.79	0.79	0.79	0.0
16	1014	D	2	0.58	0.58	0.58	0.58	0.58	0.58	0.0
16	1014	C	1	1.03	1.03	1.03	1.03	1.03	1.03	0.0
16	1014	C	2	0.64	0.58	0.58	0.64	0.58	0.60	0.03
16	1015	D	2	0.82	0.82	0.82	0.82	0.70	0.80	0.05
16	1015	C	1	0.97	1.03	1.03	1.03	1.03	1.02	0.03

RING	SN	OPER\$	MGAGE	FN(1)	FN(2)	FN(3)	FN(4)	FN(5)	FNAVg	FNSTD
16	1015	C	2	0.82	0.82	0.82	0.82	0.82	0.82	0.0
16	1015	D	1	0.91	0.91	0.91	0.91	0.91	0.91	0.0
16	1016	D	2	0.76	0.82	0.76	0.82	0.82	0.80	0.03
16	1016	D	1	0.79	0.79	0.79	0.79	0.79	0.79	0.0
16	1016	C	1	0.85	0.91	0.91	0.85	1.03	0.91	0.08
16	1016	C	2	0.82	0.76	0.76	0.70	0.70	0.75	0.05
16	1018	C	1	0.91	0.91	0.91	1.03	0.91	0.93	0.06
16	1018	D	2	0.82	0.82	0.70	0.70	0.82	0.77	0.07
16	1018	D	1	0.66	0.79	0.66	0.79	0.79	0.74	0.07
16	1018	C	2	0.82	0.76	0.76	0.76	0.70	0.76	0.04
16	1019	C	1	1.18	1.18	1.18	1.18	1.18	1.18	0.0
16	1019	C	2	0.94	0.94	0.94	0.94	0.81	0.91	0.05
16	1019	D	1	1.05	0.93	0.93	0.93	0.93	0.96	0.05
16	1019	D	2	0.94	0.94	0.94	0.94	0.94	0.94	0.0
16	1020	C	1	1.12	1.05	1.12	1.18	1.18	1.13	0.05
16	1020	D	2	1.06	1.06	1.06	1.06	1.06	1.06	0.0
16	1020	D	1	1.18	1.18	1.05	0.93	1.05	1.08	0.10
16	1020	C	2	1.06	1.06	1.12	1.06	1.06	1.07	0.03
16	1023	D	1	0.66	0.54	0.54	0.66	0.66	0.61	0.07
16	1023	C	1	0.72	0.66	0.72	0.79	0.79	0.74	0.05
16	1023	C	2	0.58	0.52	0.58	0.58	0.58	0.57	0.03
16	1023	D	2	0.58	0.52	0.58	0.58	0.58	0.57	0.03
16	1024	C	1	0.79	0.79	0.85	0.85	0.97	0.85	0.08
16	1024	D	2	0.58	0.58	0.70	0.70	0.70	0.65	0.07
16	1024	C	2	0.82	0.82	0.76	0.76	0.82	0.80	0.03
16	1024	D	1	0.79	0.79	0.79	0.91	0.79	0.81	0.06
16	1025	D	2	0.70	0.70	0.70	0.70	0.70	0.70	0.0
16	1025	C	2	0.76	0.70	0.82	0.76	0.82	0.77	0.05
16	1025	C	1	0.79	0.79	0.79	0.91	0.85	0.82	0.06
16	1025	D	1	0.79	0.79	0.79	0.79	0.79	0.79	0.0
16	1026	D	2	1.67	1.67	1.60	1.67	1.67	1.65	0.03
16	1026	D	1	1.55	1.55	1.55	1.55	1.67	1.57	0.05
16	1026	C	2	1.79	1.67	1.67	1.79	1.67	1.71	0.07
16	1026	C	1	1.73	1.67	1.55	1.67	1.79	1.68	0.09
17	754	C	2	2.27	2.33	2.33	2.39	2.27	2.32	0.05
17	754	D	1	2.28	2.28	2.28	2.28	2.28	2.28	0.0
17	754	D	2	2.27	2.33	2.27	2.27	2.27	2.29	0.03
17	754	C	1	2.40	2.40	2.40	2.40	2.40	2.40	0.0
17	756	C	2	2.04	2.04	2.04	2.04	2.04	2.04	0.0
17	756	D	1	2.14	2.14	2.14	2.20	2.14	2.15	0.03

RING	SN	OPER\$	MGAGE	FN(1)	FN(2)	FN(3)	FN(4)	FN(5)	FNAVG	FNSTD
17	756	D	2	2.04	2.04	2.04	2.04	2.04	2.04	0.0
17	756	C	1	2.26	2.26	2.26	2.26	2.26	2.26	0.0
17	757	C	1	2.63	2.75	2.51	2.63	2.75	2.66	0.10
17	757	C	2	2.52	2.70	2.77	2.46	2.52	2.59	0.13
17	757	D	1	2.38	2.51	2.51	2.51	2.75	2.53	0.13
17	757	D	2	2.52	2.77	2.64	2.52	2.64	2.62	0.10
17	760	C	2	2.28	2.34	2.28	2.28	2.28	2.29	0.03
17	760	D	1	2.26	2.26	2.26	2.26	2.26	2.26	0.0
17	760	D	2	2.28	2.40	2.28	2.28	2.28	2.30	0.05
17	760	C	1	2.51	2.51	2.38	2.38	2.38	2.43	0.07
17	761	D	2	2.58	2.58	2.39	2.64	2.64	2.56	0.10
17	761	D	1	2.52	2.52	2.52	2.52	2.71	2.56	0.08
17	761	C	2	2.70	2.64	2.70	2.64	2.76	2.69	0.05
17	761	C	1	2.71	2.71	2.77	2.77	2.71	2.73	0.03
17	762	C	2	2.28	2.28	2.40	2.46	2.52	2.39	0.11
17	762	C	1	2.63	2.51	2.63	2.69	2.63	2.62	0.07
17	762	D	2	2.40	2.40	2.28	2.40	2.40	2.38	0.05
17	762	D	1	2.38	2.51	2.51	2.51	2.51	2.48	0.06
17	763	C	2	2.34	2.40	2.40	2.34	2.34	2.36	0.03
17	763	D	1	2.38	2.32	2.38	2.32	2.38	2.36	0.03
17	763	D	2	2.28	2.40	2.40	2.40	2.40	2.38	0.05
17	763	C	1	2.51	2.63	2.51	2.51	2.63	2.56	0.07
17	764	D	2	2.39	2.27	2.27	2.39	2.52	2.37	0.10
17	764	C	2	2.46	2.39	2.39	2.52	2.52	2.46	0.06
17	764	C	1	2.46	2.34	2.46	2.46	2.46	2.44	0.05
17	764	D	1	2.40	2.28	2.40	2.34	2.46	2.38	0.07
17	768	C	1	2.38	2.38	2.38	2.51	2.51	2.43	0.07
17	768	D	1	2.26	2.26	2.26	2.26	2.26	2.26	0.0
17	768	D	2	2.40	2.40	2.52	2.34	2.46	2.42	0.07
17	768	C	2	2.52	2.46	2.52	2.46	2.46	2.49	0.03
17	769	D	1	2.14	2.26	2.26	2.20	2.26	2.23	0.06
17	769	C	1	2.38	2.26	2.26	2.38	2.38	2.34	0.07
17	769	C	2	2.10	2.04	2.04	2.16	2.10	2.08	0.05
17	769	D	2	2.16	2.04	2.04	2.04	2.04	2.06	0.05
17	770	D	1	2.38	2.51	2.38	2.38	2.38	2.41	0.06
17	770	C	1	2.38	2.51	2.38	2.38	2.51	2.43	0.07
17	770	D	2	2.52	2.52	2.52	2.52	2.52	2.52	0.0
17	770	C	2	2.52	2.52	2.52	2.52	2.52	2.52	0.0
17	771	C	2	2.40	2.64	2.34	2.52	2.52	2.49	0.12
17	771	C	1	2.45	2.51	2.38	2.51	2.51	2.47	0.06

RING	SN	OPERŞ	MGAGE	FN(1)	FN(2)	FN(3)	FN(4)	FN(5)	FNAVG	FNSTD
17	771	D	2	2.40	2.64	2.40	2.52	2.52	2.50	0.10
17	771	D	1	2.38	2.38	2.26	2.38	2.38	2.36	0.06
17	773	C	1	1.52	1.65	1.52	1.52	1.52	1.55	0.06
17	773	D	1	1.46	1.65	1.65	1.52	1.52	1.56	0.08
17	773	D	2	1.55	1.55	1.55	1.43	1.55	1.53	0.05
17	773	C	2	1.67	1.55	1.55	1.49	1.49	1.55	0.07
17	774	C	1	2.26	1.77	2.14	2.02	2.02	2.04	0.18
17	774	C	2	2.28	2.04	2.28	2.22	2.16	2.19	0.10
17	774	D	1	2.26	1.77	2.14	2.02	1.89	2.02	0.19
17	774	D	2	2.28	2.04	2.16	2.16	2.04	2.13	0.10
17	777	D	2	2.04	2.04	2.04	2.04	2.04	2.04	0.0
17	777	C	1	2.20	2.26	2.26	2.26	2.26	2.25	0.03
17	777	D	1	2.14	2.14	2.14	2.14	2.14	2.14	0.0
17	777	C	2	2.04	2.04	2.04	2.04	2.04	2.04	0.0
18	153	D	2	8.23	7.99	8.35	8.35	8.23	8.23	0.15
18	153	D	1	8.60	8.41	8.17	8.41	8.41	8.40	0.15
18	153	C	2	8.35	7.99	8.54	8.54	8.23	8.33	0.23
18	153	C	1	8.29	7.92	8.66	8.41	8.41	8.34	0.27
18	1299	D	2	9.08	9.08	9.56	9.44	9.81	9.39	0.32
18	1299	D	1	9.51	8.77	9.39	9.51	9.39	9.31	0.31
18	1299	C	2	9.56	9.68	9.62	9.20	9.38	9.49	0.20
18	1299	C	1	9.51	9.32	9.51	8.90	9.75	9.40	0.32
18	1304	D	1	8.54	8.90	8.78	8.90	8.84	8.79	0.15
18	1304	D	2	8.72	9.20	9.08	9.14	9.08	9.05	0.19
18	1304	C	2	9.02	9.08	9.33	9.14	9.20	9.16	0.12
18	1304	C	1	8.90	9.03	9.03	9.15	9.03	9.03	0.09
18	1305	C	1	9.27	8.78	8.90	9.52	9.52	9.20	0.34
18	1305	D	2	9.33	9.08	9.08	9.69	9.45	9.33	0.26
18	1305	C	2	9.27	8.84	9.14	9.51	9.69	9.29	0.33
18	1305	D	1	8.90	8.66	9.03	9.52	9.46	9.11	0.37
18	1306	C	1	8.41	7.92	8.41	8.41	8.41	8.31	0.22
18	1306	C	2	8.11	8.11	8.54	8.35	8.60	8.34	0.23
18	1306	D	1	7.98	7.80	8.04	8.41	8.41	8.13	0.27
18	1306	D	2	8.11	8.05	8.35	8.48	8.35	8.27	0.18
18	1308	D	1	8.90	8.78	9.15	9.40	9.27	9.10	0.26
18	1308	D	2	9.20	9.20	9.45	9.81	9.63	9.46	0.27
18	1308	C	2	9.57	9.33	9.57	9.63	9.57	9.53	0.12
18	1308	C	1	9.40	9.15	9.40	9.64	9.64	9.45	0.21
18	1309	C	2	9.27	9.33	9.45	9.20	9.33	9.31	0.09
18	1309	D	2	9.20	9.20	9.33	9.20	9.20	9.23	0.05

RING	SN	OPERS	MGAGE	FN(1)	FN(2)	FN(3)	FN(4)	FN(5)	FNAVG	FNSTD
18	1309	D	1	8.78	8.90	9.27	8.90	9.03	8.98	0.19
18	1309	C	1	9.03	9.03	9.40	9.03	9.03	9.10	0.17
18	1311	C	1	7.74	8.04	8.17	7.67	7.92	7.91	0.21
18	1311	C	2	7.99	8.35	8.41	8.11	8.35	8.24	0.18
18	1311	D	1	7.55	7.92	8.04	7.92	8.04	7.90	0.20
18	1311	D	2	7.99	8.17	8.35	8.11	8.11	8.15	0.13
18	1312	D	2	8.60	8.23	7.62	8.35	8.35	8.23	0.36
18	1312	D	1	8.41	8.04	7.80	8.41	8.35	8.20	0.27
18	1312	C	2	8.60	8.48	7.87	8.48	8.72	8.43	0.33
18	1312	C	1	8.41	8.17	7.92	8.29	8.41	8.24	0.21
18	1314	C	1	8.66	8.90	9.03	9.03	9.15	8.95	0.19
18	1314	D	2	9.08	9.20	9.33	9.33	9.33	9.25	0.11
18	1314	C	2	9.20	9.45	9.45	9.33	9.33	9.35	0.10
18	1314	D	1	8.90	8.90	9.03	9.03	9.03	8.98	0.07
18	1318	D	1	8.90	9.09	9.40	9.15	8.78	9.06	0.24
18	1318	C	1	9.27	9.15	9.52	9.03	9.21	9.24	0.18
18	1318	D	2	9.33	9.33	9.57	9.02	9.33	9.31	0.19
18	1318	C	2	9.45	9.57	9.69	9.33	9.08	9.42	0.23
18	1329	C	2	9.08	8.84	8.72	8.60	8.60	8.77	0.20
18	1329	D	1	8.84	8.47	8.66	8.41	8.41	8.56	0.19
18	1329	D	2	9.20	8.72	8.60	8.72	8.60	8.77	0.25
18	1329	C	1	9.15	8.41	8.41	8.29	8.66	8.58	0.34
18	1334	D	1	8.90	8.90	8.90	9.08	9.08	8.97	0.10
18	1334	C	2	9.20	9.08	9.20	8.96	9.20	9.13	0.11
18	1334	C	1	9.39	9.14	9.32	8.90	9.26	9.20	0.19
18	1334	D	2	9.20	9.08	9.20	9.08	9.08	9.13	0.07
18	1355	D	1	8.66	8.60	8.72	8.90	8.66	8.71	0.12
18	1355	D	2	8.96	9.20	8.96	8.72	9.08	8.99	0.18
18	1355	C	2	8.96	9.20	8.84	8.48	8.84	8.86	0.26
18	1355	C	1	9.15	9.27	9.15	8.90	9.15	9.13	0.13
19	156	C	1	15.18	15.30	15.05	15.05	15.05	15.13	0.11
19	156	C	2	14.43	14.43	14.55	14.43	14.43	14.45	0.05
19	156	D	1	15.05	14.87	14.81	15.18	15.05	14.99	0.15
19	156	D	2	14.43	14.67	14.43	14.43	14.55	14.50	0.11
19	157	D	1	13.95	13.39	13.82	14.19	13.82	13.84	0.29
19	157	C	2	12.97	13.82	13.58	13.34	12.97	13.34	0.37
19	157	C	1	13.70	13.58	14.07	13.82	13.82	13.80	0.18
19	157	D	2	12.97	13.21	13.58	13.34	13.46	13.31	0.23
19	158	D	1	16.04	16.04	16.16	16.04	16.28	16.11	0.11
19	158	C	1	16.65	16.16	15.91	16.53	16.78	16.41	0.36

RING	SN	OPER\$	MGAGE	FN(1)	FN(2)	FN(3)	FN(4)	FN(5)	FNAVG	FNSTD
19	158	C	2	15.64	15.64	15.52	15.52	15.89	15.64	0.15
19	158	D	2	16.01	15.16	15.64	15.52	15.89	15.64	0.33
19	159	C	1	15.02	14.78	15.51	14.04	14.41	14.75	0.56
19	159	C	2	14.54	15.52	14.42	13.45	14.54	14.50	0.73
19	159	D	1	15.14	14.04	15.14	15.02	15.02	14.87	0.47
19	159	D	2	14.54	15.15	14.67	14.67	15.15	14.84	0.29
19	160	D	2	14.54	14.67	14.79	14.67	14.79	14.69	0.10
19	160	D	1	15.51	15.51	15.20	15.27	15.27	15.35	0.15
19	160	C	2	14.54	14.91	15.03	14.79	14.67	14.79	0.19
19	160	C	1	15.02	15.51	15.27	15.02	15.27	15.22	0.20
19	161	C	1	15.30	14.32	14.38	14.81	14.81	14.72	0.40
19	161	D	2	14.91	13.82	14.06	14.67	14.67	14.43	0.46
19	161	D	1	15.05	14.32	14.38	14.68	14.56	14.60	0.29
19	161	C	2	14.91	14.19	14.43	14.61	14.67	14.56	0.27
19	162	C	2	14.91	15.16	14.67	14.67	14.43	14.77	0.28
19	162	C	1	14.68	15.05	14.93	14.81	14.81	14.86	0.14
19	162	D	1	14.56	15.18	14.68	14.56	14.50	14.70	0.28
19	162	D	2	14.55	15.04	14.67	14.43	14.43	14.62	0.25
19	163	C	1	13.73	14.35	13.92	13.80	14.04	13.97	0.24
19	163	C	2	13.69	14.18	13.69	13.69	13.94	13.84	0.22
19	163	D	1	13.73	13.98	14.29	13.55	13.92	13.89	0.28
19	163	D	2	13.39	13.94	13.57	13.57	13.69	13.63	0.20
19	164	D	2	13.70	14.06	13.46	13.58	13.58	13.68	0.23
19	164	C	1	14.07	14.56	13.70	13.58	13.82	13.95	0.39
19	164	C	2	13.70	13.94	13.21	13.70	13.46	13.60	0.28
19	164	D	1	13.82	14.44	13.70	13.58	13.52	13.81	0.37
19	166	D	2	16.49	16.01	15.52	15.52	16.01	15.91	0.41
19	166	C	1	16.28	16.16	16.04	16.28	16.41	16.23	0.14
19	166	C	2	16.37	16.01	15.89	15.89	16.13	16.06	0.20
19	166	D	1	16.28	16.16	15.98	16.04	16.04	16.10	0.12
19	168	D	2	16.01	15.28	14.91	15.28	15.40	15.38	0.40
19	168	D	1	16.04	15.55	14.99	15.30	15.67	15.51	0.39
19	168	C	2	15.89	15.40	15.16	15.28	15.40	15.43	0.28
19	168	C	1	15.91	16.04	15.55	15.55	15.61	15.73	0.23
19	170	D	1	15.55	15.30	15.30	15.30	15.55	15.40	0.13
19	170	C	2	15.40	15.34	15.40	15.40	15.40	15.39	0.03
19	170	C	1	15.73	15.42	15.55	15.55	15.79	15.61	0.15
19	170	D	2	15.16	15.16	15.10	15.16	15.10	15.13	0.03
19	172	D	2	14.73	14.91	14.42	14.79	14.91	14.75	0.20
19	172	D	1	14.78	14.78	14.65	14.78	14.90	14.78	0.09

RING	SN	OPERŞ	MGAGE	FN(1)	FN(2)	FN(3)	FN(4)	FN(5)	FNAVG	FNSTD
19	172	C	2	14.67	15.15	14.67	14.91	15.15	14.91	0.24
19	172	C	1	14.65	14.90	14.53	14.78	14.90	14.75	0.16
19	670	C	2	15.77	15.40	15.52	15.89	15.64	15.64	0.19
19	670	D	2	15.16	15.16	15.40	15.40	15.40	15.30	0.13
19	670	C	1	15.79	15.61	15.79	15.85	16.04	15.82	0.15
19	670	D	1	15.67	15.55	15.55	15.55	15.67	15.60	0.07
19	1538	C	2	15.40	15.16	15.04	14.79	14.79	15.04	0.26
19	1538	D	2	15.16	14.91	14.91	14.79	15.04	14.96	0.14
19	1538	C	1	15.55	15.18	15.05	15.18	15.18	15.23	0.19
19	1538	D	1	15.30	14.81	14.81	12.47	14.93	14.46	1.13
21	465	D	2	99.62	95.33	97.10	97.10	97.10	97.25	1.53
21	465	C	1	95.37	96.42	96.16	94.33	95.90	95.63	0.83
21	465	C	2	99.87	98.36	95.59	97.10	98.11	97.80	1.59
21	465	D	1	94.33	93.81	91.20	93.81	95.90	93.81	1.69
21	1215	D	2	99.37	96.85	97.35	96.85	98.36	97.75	1.09
21	1215	D	1	94.07	94.33	90.41	91.72	94.85	93.08	1.91
21	1215	C	2	99.87	94.33	97.35	97.35	94.83	96.75	2.24
21	1215	C	1	95.11	93.81	94.07	93.02	94.85	94.17	0.84
21	1216	D	2	96.85	96.59	95.84	93.07	93.32	95.13	1.81
21	1216	D	1	95.11	88.85	89.37	93.28	92.50	91.82	2.66
21	1216	C	2	94.83	92.31	95.59	93.82	93.07	93.92	1.32
21	1216	C	1	94.33	89.11	92.76	90.15	88.33	90.94	2.53
21	1221	C	1	86.50	90.15	89.37	89.11	89.63	88.95	1.42
21	1221	C	2	92.31	91.30	93.07	90.04	91.05	91.55	1.17
21	1221	D	1	85.98	90.94	88.33	90.15	87.80	88.64	1.97
21	1221	D	2	91.05	91.55	89.03	91.05	93.57	91.25	1.62
21	1224	C	1	90.68	91.46	95.63	95.37	90.41	92.71	2.58
21	1224	C	2	94.33	96.09	93.57	95.84	97.35	95.43	1.50
21	1224	D	1	90.41	90.15	93.81	92.76	93.02	92.03	1.64
21	1224	D	2	93.57	98.36	95.84	96.85	96.85	96.29	1.77
21	1225	D	2	99.37	94.33	94.58	95.84	98.86	96.59	2.38
21	1225	D	1	95.11	93.55	90.15	95.63	93.55	93.60	2.14
21	1225	C	2	95.59	94.83	98.11	97.35	95.33	96.24	1.41
21	1225	C	1	95.37	95.37	93.81	92.24	94.07	94.17	1.30
21	1228	C	1	89.37	89.89	91.72	89.11	90.94	90.21	1.10
21	1228	C	2	91.05	93.57	92.31	93.07	93.07	92.61	0.98
21	1228	D	1	89.11	90.94	86.24	88.59	88.33	88.64	1.69
21	1228	D	2	89.29	93.57	94.58	92.31	94.33	92.81	2.16
21	1230	D	2	94.33	94.58	98.11	99.11	97.10	96.64	2.13
21	1230	C	1	93.81	92.24	90.94	94.85	93.28	93.02	1.50

RING	SN	OPERS	MGAGE	FN(1)	FN(2)	FN(3)	FN(4)	FN(5)	FNAVG	FNSTD
21	1230	C	2	96.85	93.82	100.63	96.09	96.09	96.69	2.47
21	1230	D	1	93.55	88.33	93.81	90.41	93.55	91.93	2.45
21	1235	C	1	93.02	94.33	93.02	92.24	96.16	93.75	1.54
21	1235	C	2	96.09	101.13	98.61	96.09	97.35	97.85	2.11
21	1235	D	1	94.33	89.11	96.16	93.28	94.33	93.44	2.63
21	1235	D	2	96.09	91.05	97.10	93.32	96.59	94.83	2.57
21	1238	D	2	94.83	96.09	97.60	96.85	97.10	96.49	1.08
21	1238	D	1	90.94	90.68	93.02	91.72	92.76	91.82	1.05
21	1238	C	2	96.09	98.61	94.83	96.09	95.33	96.19	1.45
21	1238	C	1	93.28	93.55	93.55	93.28	93.02	93.34	0.22
21	1239	C	1	92.76	92.24	94.85	92.76	95.63	93.65	1.49
21	1239	C	2	95.33	95.33	98.36	94.83	97.35	96.24	1.53
21	1239	D	1	93.81	94.33	93.02	91.72	88.33	92.24	2.40
21	1239	D	2	95.59	95.59	95.33	99.11	99.37	97	2.05
21	1240	C	1	91.98	93.55	96.94	93.28	95.90	94.33	2.03
21	1240	C	2	99.87	98.61	100.37	96.59	97.35	98.56	1.61
21	1240	D	1	93.28	96.68	96.94	91.46	90.41	93.75	2.97
21	1240	D	2	97.85	99.37	99.11	99.11	98.61	98.81	0.60
21	1241	C	1	91.72	93.81	92.24	92.76	92.24	92.55	0.79
21	1241	C	2	95.08	95.59	95.33	97.10	95.84	95.79	0.78
21	1241	D	1	91.72	90.94	90.41	88.33	93.02	90.88	1.74
21	1241	D	2	92.06	93.57	95.33	94.33	93.57	93.77	1.20
21	1242	C	2	96.85	94.33	96.09	93.07	94.07	94.88	1.55
21	1242	D	2	94.58	95.59	97.60	94.58	96.85	95.84	1.36
21	1242	D	1	87.54	88.85	92.24	92.24	92.24	90.62	2.26
21	1242	C	1	90.94	92.50	91.98	91.46	93.02	91.98	0.83
21	1243	C	1	85.45	85.72	86.76	87.28	84.41	85.92	1.13
21	1243	D	2	89.54	89.54	90.29	89.54	90.29	89.84	0.41
21	1243	D	1	85.45	85.19	90.41	84.67	88.06	86.76	2.43
21	1243	C	2	91.05	87.77	91.30	91.05	87.27	89.69	1.99
23	793	C	1	109.99	108.94	108.42	109.47	109.99	109.36	0.68
23	793	C	2	113.73	114.99	114.74	114.74	115.49	114.74	0.64
23	793	D	1	105.29	109.73	108.94	104.77	104.51	106.65	2.49
23	793	D	2	114.23	115.75	110.45	110.71	108.19	111.87	3.06
23	799	D	2	111.21	114.49	109.95	110.45	114.23	112.07	2.14
23	799	D	1	108.42	109.99	109.73	109.99	110.25	109.68	0.72
23	799	C	2	113.73	113.23	112.22	113.73	113.23	113.23	0.62
23	799	C	1	109.99	109.73	109.21	112.08	111.03	110.41	1.15
23	816	C	1	108.94	109.99	109.99	108.68	108.68	109.26	0.68
23	816	C	2	112.22	110.45	109.95	113.23	111.21	111.41	1.33

RING	SN	OPER\$	MGAGE	FN(1)	FN(2)	FN(3)	FN(4)	FN(5)	FNAVG	FNSTD
23	816	D	1	107.12	107.90	107.90	107.64	106.86	107.48	0.47
23	816	D	2	110.71	110.96	112.47	111.97	110.71	111.36	0.81
23	822	D	1	107.90	111.29	111.56	NA	109.99	110.18	1.67
23	822	D	2	113.73	113.48	116.50	116.50	115.24	115.09	1.45
23	822	C	1	110.25	NA	112.34	111.56	111.82	111.49	0.89
23	822	C	2	113.23	113.73	114.99	114.49	114.74	114.23	0.73
24	672	D	1	67.18	68.49	69.01	69.79	72.40	69.38	1.94
24	672	D	2	72.65	70.89	71.90	68.87	69.63	70.79	1.56
24	672	C	1	67.97	67.97	73.97	68.75	69.27	69.59	2.51
24	672	C	2	69.88	72.65	71.14	69.38	71.90	70.99	1.36
24	673	C	1	65.62	68.75	70.06	65.88	68.75	67.81	1.96
24	673	C	2	68.37	71.14	71.14	69.38	71.90	70.39	1.46
24	673	D	1	66.01	66.14	69.40	66.14	66.79	66.90	1.43
24	673	D	2	70.39	70.64	70.89	70.13	70.64	70.54	0.29
24	682	C	2	76.18	71.39	73.41	73.16	71.39	73.11	1.96
24	682	D	1	67.45	68.75	72.14	71.10	72.67	70.42	2.24
24	682	D	2	68.62	69.13	74.67	73.16	70.64	71.24	2.60
24	682	C	1	68.49	69.53	69.01	71.36	71.88	70.06	1.49
24	1569	D	2	76.18	72.15	72.65	72.91	74.17	73.61	1.62
24	1569	D	1	71.36	70.84	71.10	70.84	72.14	71.26	0.54
24	1569	C	2	71.90	72.65	74.42	72.15	73.41	72.91	1.02
24	1569	C	1	74.49	71.88	71.10	70.84	69.53	71.57	1.84
24	1572	C	1	72.67	70.06	71.10	75.01	72.40	72.25	1.87
24	1572	D	2	74.42	72.65	73.66	74.17	73.16	73.61	0.72
24	1572	D	1	73.19	70.58	72.67	72.40	72.40	72.25	0.99
24	1572	C	2	78.95	74.17	73.91	72.15	73.91	74.62	2.55
24	1577	C	1	75.80	74.23	71.36	75.28	75.28	74.39	1.79
24	1577	C	2	76.43	76.94	73.41	76.94	72.91	75.33	2
24	1577	D	1	74.49	73.71	72.67	74.49	74.75	74.02	0.85
24	1577	D	2	74.92	75.17	77.19	75.68	76.69	75.93	0.98
24	1581	D	2	75.43	74.17	75.68	76.94	77.44	75.93	1.30
24	1581	D	1	68.75	68.75	66.14	73.97	74.75	70.47	3.72
24	1581	C	2	76.18	73.66	73.41	76.43	72.65	74.47	1.72
24	1581	C	1	71.36	73.19	75.80	71.36	75.28	73.40	2.10
24	1585	C	1	72.93	71.36	70.06	71.36	71.88	71.52	1.04
24	1585	C	2	74.17	73.66	73.16	73.16	73.16	73.46	0.45
24	1585	D	1	72.14	70.84	70.06	70.58	71.88	71.10	0.89
24	1585	D	2	72.91	72.65	73.41	74.42	74.42	73.56	0.83
24	1587	C	2	73.41	72.65	73.91	72.65	74.17	73.36	0.70
24	1587	C	1	73.71	72.14	71.36	73.97	73.19	72.87	1.10

RING	SN	OPER\$	MGAGE	FN(1)	FN(2)	FN(3)	FN(4)	FN(5)	FNAVG	FNSTD
24	1587	D	1	73.45	72.14	71.88	73.45	73.45	72.87	0.79
24	1587	D	2	73.66	74.42	75.17	74.42	74.42	74.42	0.53
24	1588	C	1	71.36	73.19	70.58	73.19	70.32	71.73	1.39
24	1588	C	2	72.91	73.16	70.64	70.13	69.63	71.29	1.63
24	1588	D	1	68.23	69.53	68.49	69.53	68.23	68.80	0.68
24	1588	D	2	73.66	72.40	73.16	73.16	71.90	72.86	0.70
24	1591	D	2	74.17	76.69	74.42	74.17	74.17	74.72	1.10
24	1591	D	1	73.71	73.19	72.67	75.80	73.97	73.87	1.19
24	1591	C	2	73.16	75.17	77.95	78.45	73.91	75.73	2.37
24	1591	C	1	73.45	73.97	76.32	72.67	72.67	73.81	1.51
24	1618	C	1	70.84	70.84	72.40	72.14	70.84	71.41	0.79
24	1618	C	2	72.65	71.90	72.65	73.91	72.65	72.75	0.73
24	1618	D	1	72.14	72.67	72.40	72.01	72.14	72.27	0.26
24	1618	D	2	72.40	72.15	74.42	72.65	72.15	72.75	0.95
24	1619	C	1	76.32	76.06	77.36	76.32	76.06	76.42	0.54
24	1619	C	2	79.71	75.93	74.42	77.19	75.68	76.59	2
24	1619	D	1	77.36	72.67	74.75	75.28	74.75	74.96	1.68
24	1619	D	2	79.46	76.18	76.18	77.95	76.43	77.24	1.44
24	1623	D	1	71.62	71.36	71.88	73.19	69.01	71.41	1.52
24	1623	C	1	74.49	73.97	70.06	73.19	71.88	72.72	1.78
24	1623	C	2	73.91	75.68	71.90	72.15	72.15	73.16	1.62
24	1623	D	2	73.16	73.66	75.43	74.17	74.42	74.17	0.85
25	508	C	1	24.03	24.03	23.91	23.79	23.91	23.93	0.10
25	508	C	2	24.39	24.45	23.91	23.91	24.39	24.21	0.28
25	508	D	1	24.03	23.91	23.54	23.79	23.97	23.85	0.19
25	508	D	2	24.39	24.39	23.91	24.03	24.39	24.22	0.24
25	509	D	2	24.39	24.39	23.91	24.27	24.15	24.22	0.20
25	509	D	1	24.03	23.91	23.54	23.79	23.91	23.84	0.19
25	509	C	1	24.16	24.03	23.79	23.91	24.03	23.98	0.14
25	509	C	2	24.63	24.15	23.91	24.15	23.91	24.15	0.30
25	510	D	2	23.06	23.06	23.42	23.06	23.18	23.15	0.16
25	510	C	1	23.05	23.05	23.42	22.93	23.17	23.12	0.19
25	510	C	2	23.06	23.30	23.91	23.30	23.42	23.40	0.31
25	510	D	1	22.68	22.68	23.17	22.68	22.93	22.83	0.22
25	512	C	2	24.33	24.39	23.78	24.15	24.21	24.17	0.24
25	512	D	2	24.27	24.15	23.91	23.85	23.91	24.02	0.18
25	512	D	1	23.91	23.91	23.17	23.66	24.16	23.76	0.37
25	512	C	1	24.40	23.91	23.66	23.79	23.91	23.93	0.28
25	515	C	2	25.36	25.36	25	25.36	25.36	25.29	0.16
25	515	C	1	24.89	24.89	24.59	24.77	25.63	24.96	0.40

RING	SN	OPER\$	MGAGE	FN(1)	FN(2)	FN(3)	FN(4)	FN(5)	FNAVG	FNSTD
25	515	D	2	24.88	25.12	25.06	25.12	25.36	25.11	0.17
25	515	D	1	24.52	24.65	24.40	24.89	24.65	24.62	0.18
25	517	C	1	22.93	22.74	23.17	22.68	23.05	22.91	0.21
25	517	C	2	23.42	23.30	23.30	23.18	23.42	23.32	0.10
25	517	D	1	22.68	22.31	23.17	22.68	22.93	22.75	0.32
25	517	D	2	23.18	22.81	23.42	22.69	23.18	23.06	0.30
25	518	D	2	23.78	23.41	23.54	23.66	23.78	23.63	0.16
25	518	D	1	23.35	23.10	23.10	23.35	23.35	23.25	0.13
25	518	C	2	23.90	23.72	23.78	23.72	23.90	23.80	0.09
25	518	C	1	23.47	23.35	23.35	23.35	23.47	23.40	0.07
25	519	C	2	23.91	24.39	23.91	23.78	24.39	24.08	0.29
25	519	D	2	23.42	24.03	23.78	24.03	24.63	23.98	0.44
25	519	C	1	23.54	23.66	23.79	23.29	24.16	23.69	0.32
25	519	D	1	23.29	23.66	23.29	23.42	23.91	23.52	0.27
25	520	C	2	24.63	24.87	24.87	24.87	24.63	24.77	0.13
25	520	D	1	24.08	24.08	24.33	24.21	24.21	24.18	0.10
25	520	C	1	24.33	24.33	24.57	24.45	24.45	24.43	0.10
25	520	D	2	24.51	24.63	24.81	24.75	24.75	24.69	0.12
25	601	C	2	24.39	24.63	24.27	24.88	24.76	24.59	0.25
25	601	C	1	24.03	24.03	23.66	24.28	24.40	24.08	0.28
25	601	D	2	24.51	24.63	24.15	24.63	24.39	24.46	0.20
25	601	D	1	24.03	24.16	23.79	24.16	24.28	24.08	0.19
26	972	D	1	17.88	17.88	18.31	18.50	18.13	18.14	0.27
26	972	D	2	17.83	17.83	18.20	18.56	17.83	18.05	0.33
26	972	C	1	18.13	18.25	18.25	18.74	18.25	18.33	0.24
26	972	C	2	18.20	18.26	18.20	18.44	18.20	18.26	0.11
26	973	C	1	17.51	17.08	17.02	17.21	17.76	17.32	0.31
26	973	C	2	17.34	17.10	16.80	16.74	17.59	17.11	0.36
26	973	D	2	17.04	16.86	16.74	16.62	17.10	16.87	0.20
26	973	D	1	17.39	17.02	16.90	16.90	17.39	17.12	0.25
26	974	C	2	18.01	17.82	17.34	17.58	17.82	17.72	0.26
26	974	D	1	17.47	17.59	17.59	17.84	17.96	17.69	0.20
26	974	D	2	17.82	17.70	17.34	17.58	18.07	17.70	0.27
26	974	C	1	17.71	17.96	17.47	17.90	17.96	17.80	0.21
26	1087	C	1	17.64	17.70	17.64	17.82	17.64	17.69	0.08
26	1087	D	2	17.28	17.34	17.47	17.59	17.34	17.41	0.12
26	1087	D	1	17.27	17.51	17.51	17.64	17.51	17.49	0.13
26	1087	C	2	17.47	17.59	17.59	17.59	17.34	17.52	0.11
26	1090	C	1	17.76	18.01	18.37	18.01	18.01	18.03	0.22
26	1090	D	2	17.34	17.95	18.32	17.59	18.20	17.88	0.41

RING	SN	OPER\$	MGAGE	FN(1)	FN(2)	FN(3)	FN(4)	FN(5)	FNAVG	FNSTD
26	1090	D	1	17.76	17.88	17.88	17.51	17.76	17.76	0.15
26	1090	C	2	17.71	17.83	18.56	17.59	17.83	17.90	0.38
26	1652	D	1	18.25	18.56	18.25	18.62	18.62	18.46	0.19
26	1652	D	2	17.59	17.71	17.71	17.83	17.59	17.69	0.10
26	1652	C	1	18.07	18.50	18.25	18.37	18.50	18.34	0.18
26	1652	C	2	17.65	17.71	17.71	17.71	17.95	17.75	0.12
26	1653	D	2	18.07	18.20	17.59	17.95	18.07	17.98	0.23
26	1653	D	1	18.50	18.37	18.01	18.44	18.50	18.36	0.21
26	1653	C	2	18.20	18.07	17.77	17.83	17.89	17.95	0.18
26	1653	C	1	18.37	18.50	17.76	18.50	18.25	18.28	0.31
26	1654	C	1	15.30	16.04	15.36	15.42	15.55	15.53	0.30
26	1654	D	2	14.91	15.52	14.31	14.91	14.91	14.91	0.43
26	1654	D	1	15.30	15.24	15.55	15.18	15.18	15.29	0.15
26	1654	C	2	15.04	14.91	14.79	14.79	14.91	14.89	0.10
26	1655	D	1	18.69	18.94	20.16	19.43	19.67	19.38	0.58
26	1655	C	2	18.49	19.16	20.25	19.04	19.16	19.22	0.64
26	1655	C	1	19.43	18.94	19.92	20.66	19.92	19.77	0.64
26	1655	D	2	18.49	18.43	20.13	19.28	19.40	19.15	0.71
26	1658	D	1	17.02	17.51	17.02	17.39	17.39	17.27	0.23
26	1658	C	2	17.22	17.34	16.86	17.34	17.10	17.17	0.20
26	1658	C	1	17.27	17.82	17.14	17.51	17.51	17.45	0.26
26	1658	D	2	16.86	17.34	16.86	17.22	17.22	17.10	0.23
26	1659	C	1	19.73	19.36	19.48	19.48	19.73	19.56	0.17
26	1659	D	2	19.17	18.99	18.80	19.05	19.05	19.01	0.13
26	1659	C	2	19.17	19.11	18.80	18.99	19.11	19.03	0.15
26	1659	D	1	19.24	19.36	19.36	19.24	19.48	19.33	0.10
26	1667	D	1	18.01	18.50	17.76	18.25	18.25	18.15	0.28
26	1667	D	2	18.07	18.07	17.59	17.83	18.07	17.93	0.22
26	1667	C	1	18.25	18.62	18.25	18.25	18.50	18.37	0.17
26	1667	C	2	18.32	18.26	17.95	18.32	18.20	18.21	0.15
26	1670	C	2	18.56	18.32	18.20	18.44	18.32	18.37	0.14
26	1670	D	1	18.25	18.37	18.50	18.13	18.37	18.33	0.14
26	1670	C	1	18.62	18.62	18.74	18.37	18.50	18.57	0.14
26	1670	D	2	18.26	18.44	18.32	18.26	18.44	18.34	0.09
26	1672	C	1	18.08	18.20	18.08	17.96	18.08	18.08	0.09
26	1672	C	2	17.89	17.95	18.19	18.19	17.82	18.01	0.17
26	1672	D	1	18.20	17.96	18.08	17.71	17.71	17.94	0.22
26	1672	D	2	17.70	17.82	17.95	18.19	17.82	17.90	0.18
26	1675	C	2	17.95	17.47	17.59	18.20	17.83	17.81	0.29
26	1675	D	1	18.07	17.64	17.64	17.88	17.76	17.80	0.18

RING	SN	OPER\$	MGAGE	FN(1)	FN(2)	FN(3)	FN(4)	FN(5)	FNAVG	FNSTD
26	1675	C	1	18.01	17.76	17.76	18.01	18.01	17.91	0.13
26	1675	D	2	18.07	17.47	17.59	17.59	17.59	17.66	0.24
27	1071	C	2	27.55	26.82	28.52	27.43	25.61	27.19	1.07
27	1071	D	1	28.34	27.48	27.11	26.55	26	27.10	0.89
27	1071	D	2	27.67	26.82	27.79	26.34	26.82	27.09	0.62
27	1071	C	1	27.60	27.23	27.60	26.74	26.37	27.11	0.54
27	1072	C	1	25.31	24.33	26.29	24.82	26.78	25.51	1.02
27	1072	D	2	25.11	26.57	25.84	26.57	27.18	26.26	0.79
27	1072	C	2	25.36	26.69	25.78	25.97	26.33	26.03	0.51
27	1072	D	1	26.53	25.92	25.55	25.43	25.06	25.70	0.56
27	1073	D	2	27.31	27.31	27.67	27.06	27.31	27.33	0.22
27	1073	D	1	28.71	28.09	27.35	28.09	28.58	28.17	0.53
27	1073	C	2	27.19	27.06	28.28	28.04	27.06	27.53	0.59
27	1073	C	1	27.85	27.11	27.60	26.98	26.86	27.28	0.42
27	1076	C	1	25.68	25.43	25.55	25.80	26.04	25.70	0.24
27	1076	C	2	26.33	25.84	25.60	25.66	25.97	25.88	0.29
27	1076	D	1	25.68	25.31	25.31	26.04	26.04	25.68	0.37
27	1076	D	2	25.84	25.84	25.30	26.33	25.97	25.86	0.37
27	1079	C	2	25.97	26.34	24.88	25.73	27.06	26	0.80
27	1079	C	1	25.57	25.63	25.26	25.63	26.37	25.69	0.41
27	1079	D	2	25.36	26.34	25.36	25.85	27.06	26	0.72
27	1079	D	1	25.94	24.65	25.57	26.12	26.12	25.68	0.62
27	1081	C	1	26.17	25.86	26.17	25.31	25.80	25.86	0.35
27	1081	C	2	27.18	27.79	26.57	26.33	26.09	26.79	0.69
27	1081	D	1	25.68	25.49	26.29	25.31	25.74	25.70	0.37
27	1081	D	2	27.18	26.94	26.94	25.84	27.18	26.82	0.56
27	1083	D	2	26.57	26.57	26.33	26.33	26.82	26.52	0.20
27	1083	C	1	26.66	26.53	26.17	26.29	26.78	26.49	0.25
27	1083	C	2	27.18	27.30	25.84	26.82	26.33	26.69	0.61
27	1083	D	1	26.17	26.78	25.80	25.43	26.29	26.09	0.51
27	1732	D	2	27.79	28.27	25.72	27.30	27.67	27.35	0.97
27	1732	C	2	28.40	26.33	28.27	27.06	28.40	27.69	0.95
27	1732	C	1	26.53	26.78	22.86	26.29	26.53	25.80	1.65
27	1732	D	1	25.92	27.76	24.94	25.80	25.19	25.92	1.11
27	1735	C	1	29.23	28.25	27.76	29.23	NA	28.62	0.74
27	1735	D	1	27.55	25.84	27.55	26.82	28.27	27.21	0.92
27	1735	C	2	28.99	28.50	27.03	29.41	28.99	28.58	0.93
27	1735	D	2	25.84	27.30	28.03	28.03	27.30	27.30	0.89
27	1736	D	2	26.57	26.69	26.33	26.45	27.30	26.67	0.38
27	1736	D	1	26.04	26.04	25.43	26.29	26.78	26.12	0.49

RING	SN	OPER\$	MGAGE	FN(1)	FN(2)	FN(3)	FN(4)	FN(5)	FNAVG	FNSTD
27	1736	C	2	26.82	26.94	26.57	26.94	27.30	26.91	0.26
27	1736	C	1	26.04	26.53	25.92	26.35	27.15	26.40	0.48
27	1743	C	1	24.57	26.29	24.08	24.70	27.02	25.33	1.26
27	1743	C	2	27.06	27.06	26.94	27.30	27.79	27.23	0.34
27	1743	D	1	24.33	25.80	23.35	25.31	24.45	24.65	0.95
27	1743	D	2	24.99	26.33	26.33	27.54	28.03	26.65	1.19
27	1748	D	2	28.40	NA	27.30	27.42	NA	27.71	0.60
27	1748	D	1	27.76	28.62	27.27	27.27	28.13	27.81	0.58
27	1748	C	2	28.40	28.52	27.30	26.57	28.52	27.86	0.88
27	1748	C	1	28	28.74	27.27	28.50	28.50	28.20	0.58
27	1750	C	1	27.76	28	28	27.51	28	27.86	0.22
27	1750	D	1	27.39	27.27	27.02	27.27	27.76	27.34	0.27
27	1750	D	2	28.27	27.67	28.03	28.52	27.54	28.01	0.41
27	1750	C	2	27.54	28.40	28.27	28.27	28.27	28.15	0.34
27	7078	C	1	25.06	25.80	25.06	25.49	24.82	25.25	0.39
27	7078	D	1	25.06	24.08	24.45	24.70	24.70	24.60	0.36
27	7078	D	2	25.84	24.75	25.36	25.60	25.84	25.48	0.45
27	7078	C	2	25.84	25.60	24.99	25.84	25.60	25.58	0.35
28	1807	D	2	73.16	73.41	75.17	74.42	72.15	73.66	1.17
28	1807	D	1	69.53	70.58	71.36	70.06	72.40	70.79	1.13
28	1807	C	2	72.65	74.17	74.92	70.89	72.91	73.11	1.55
28	1807	C	1	64.84	70.06	71.36	70.06	71.62	69.59	2.75
29	840	C	1	40.82	40.04	41.09	40.56	40.04	40.51	0.47
29	840	D	2	41.28	41.15	41.66	42.41	41.41	41.58	0.50
29	840	D	1	42.13	41.87	42.78	40.82	42.13	41.95	0.71
29	840	C	2	42.92	41.15	41.66	42.16	41.41	41.86	0.70
29	1720	C	2	40.90	40.40	39.64	41.15	40.65	40.55	0.58
29	1720	D	1	39	38.74	38.48	39	40.04	39.05	0.60
29	1720	D	2	40.65	40.90	41.15	39.89	40.65	40.65	0.47
29	1720	C	1	38.48	39	39.26	39.26	39.26	39.05	0.34
29	1726	D	1	39.26	39.26	39.26	40.04	39.26	39.41	0.35
29	1726	C	2	40.90	40.15	39.89	40.90	40.90	40.55	0.49
29	1726	C	1	40.56	39.52	38.48	40.04	40.90	40.55	0.77
29	1726	D	2	40.90	40.27	40.15	40.90	40.65	40.57	0.35
29	1802	D	2	43.42	41.91	41.41	41.66	42.92	42.26	0.87
29	1802	D	1	40.04	39.78	40.30	40.82	40.82	40.35	0.47
29	1802	C	2	40.65	43.93	42.67	42.41	41.41	42.21	1.25
29	1802	C	1	38.74	41.09	41.35	40.30	41.61	40.62	1.16
29	1857	C	2	41.66	43.67	42.41	44.18	43.17	43.02	1
29	1857	D	2	44.18	41.15	42.92	44.18	43.67	43.22	1.27

RING	SN	OPERS	MGAGE	FN(1)	FN(2)	FN(3)	FN(4)	FN(5)	FNAVG	FNSTD
29	1857	D	1	40.04	42.65	41.87	42	41.93	41.70	0.98
29	1857	C	1	40.04	42.91	40.82	42.39	41.35	41.50	1.16
29	2040	C	1	35.87	34.04	36.65	37.43	36.65	36.13	1.29
29	2040	D	2	37.37	36.87	37.12	37.88	35.36	36.92	0.95
29	2040	D	1	37.17	35.87	36.91	34.82	35.87	36.13	0.94
29	2040	C	2	37.88	37.88	35.11	35.36	38.13	36.87	1.50
29	2042	C	1	37.43	36.91	36.65	38.21	36.65	37.17	0.67
29	2042	C	2	37.37	37.63	37.88	38.13	37.63	37.73	0.29
29	2042	D	1	37.17	35.87	36.91	36.13	36.91	36.60	0.57
29	2042	D	2	38.13	37.37	36.87	37.88	37.88	37.63	0.50
29	2043	C	1	15.02	13.80	15.02	16	15.02	14.97	0.78
29	2043	C	2	13.69	15.15	13.21	13.94	14.42	14.08	0.74
29	2043	D	1	15.51	16.98	15.02	15.02	16.73	15.85	0.94
29	2043	D	2	14.67	13.69	12.96	13.94	13.94	13.84	0.61
29	2044	D	2	37.50	38.89	37.12	37.63	38.89	38	0.83
29	2044	D	1	36.65	36.13	36.91	35.87	37.95	36.70	0.81
29	2044	C	2	38.38	37.88	37.12	36.62	38.63	37.73	0.85
29	2044	C	1	36.65	36.65	34.82	35.60	37.95	36.33	1.19
29	2045	C	1	42.65	40.30	40.30	44.48	41.61	41.87	1.76
29	2045	D	2	43.55	41.91	41.41	43.17	41.91	42.39	0.92
29	2045	D	1	41.87	39.78	39.78	41.87	41.09	40.88	1.05
29	2045	C	2	42.16	42.16	41.53	42.16	41.41	41.88	0.38
29	2046	D	2	39.39	39.64	39.39	38.51	39.39	39.26	0.44
29	2046	C	1	39	36.91	38.34	37.17	36.91	37.67	0.95
29	2046	D	1	37.17	38.48	38.48	38.48	38.48	38.21	0.58
29	2046	C	2	39.64	39.14	39.64	38.63	39.39	39.29	0.42
29	2047	D	1	36.91	38.48	39.13	39.78	38.74	38.61	1.07
29	2047	C	1	37.43	38.74	38.48	38.74	38.48	38.37	0.54
29	2047	C	2	41.15	40.15	38.89	40.15	39.89	40.05	0.81
29	2047	D	2	39.14	40.15	39.89	39.89	40.15	39.84	0.41
30	1823	C	2	43.67	43.93	46.19	45.94	45.94	45.14	1.23
30	1823	D	1	44.74	43.70	45.78	44.74	45	44.79	0.75
30	1823	D	2	45.69	45.82	46.70	45.44	45.44	45.82	0.52
30	1823	C	1	44.74	45.26	45.78	45.26	45.26	45.26	0.37
30	1824	D	2	46.45	46.95	45.69	47.45	46.70	46.65	0.65
30	1824	C	1	45.26	47.35	45.52	47.09	45	46.04	1.09
30	1824	C	2	47.20	45.69	47.20	46.95	47.08	46.82	0.64
30	1824	D	1	45	44.74	42.39	42.91	41.61	43.33	1.48
30	1838	D	2	44.93	47.71	48.97	48.34	47.20	47.43	1.54
30	1838	D	1	46.96	45.52	45.52	47.61	46.31	46.38	0.91

RING	SN	OPER\$	MGAGE	FN(1)	FN(2)	FN(3)	FN(4)	FN(5)	FNAVG	FNSTD
30	1838	C	2	45.19	47.20	48.97	48.21	46.95	47.30	1.43
30	1838	C	1	45.78	47.09	47.35	46.04	48.39	46.93	1.05
30	1843	C	1	39.78	37.95	38.34	38.21	38.21	38.50	0.73
30	1843	C	2	40.15	39.39	39.89	39.39	39.14	39.59	0.41
30	1843	D	1	39.52	37.69	37.82	37.95	37.95	38.19	0.75
30	1843	D	2	39.39	39.39	38.89	39.64	39.14	39.29	0.29
30	1859	D	2	47.71	47.71	46.45	47.71	46.95	47.30	0.58
30	1859	C	1	47.61	46.31	46.31	48.13	46.31	46.93	0.88
30	1859	C	2	48.08	47.20	46.45	45.94	46.45	46.82	0.84
30	1859	D	1	46.83	46.96	46.31	48.13	46.04	46.85	0.81
30	1876	C	1	44.22	43.70	41.09	42.65	42.13	42.76	1.25
30	1876	D	2	43.42	42.41	42.16	42.67	42.41	42.62	0.48
30	1876	D	1	42	43.70	41.87	41.09	41.87	42.10	0.96
30	1876	C	2	43.42	42.41	42.29	42.79	42.16	42.62	0.51
30	1878	C	2	42.92	48.71	46.70	46.19	44.43	45.79	2.22
30	1878	D	1	46.83	42.91	46.31	43.70	46.04	45.16	1.74
30	1878	C	1	45.52	44.74	45.78	46.31	42.13	44.90	1.65
30	1878	D	2	42.41	47.45	45.06	47.45	44.93	45.46	2.10
30	2051	C	1	48	47.09	46.83	47.61	47.09	47.32	0.47
30	2051	C	2	48.71	49.72	47.45	50.48	48.71	49.02	1.15
30	2051	D	1	47.09	48.13	47.09	49.70	47.35	47.87	1.11
30	2051	D	2	47.58	47.20	49.72	50.23	50.48	49.04	1.54
30	2052	D	1	44.61	45.91	46.83	46.83	46.57	46.15	0.94
30	2052	D	2	46.57	47.45	47.71	47.96	47.45	47.43	0.52
30	2052	C	1	45	46.57	46.57	46.31	45.26	45.94	0.75
30	2052	C	2	46.70	48.97	47.71	48.46	46.95	47.76	0.97
30	2054	D	1	44.74	44.87	45	44.61	45.26	44.90	0.25
30	2054	C	2	46.45	45.19	45.94	45.19	46.32	45.82	0.60
30	2054	C	1	43.43	43.43	44.48	45	43.56	43.98	0.72
30	2054	D	2	46.45	44.18	45.94	46.95	45.19	45.74	1.09
30	2058	C	1	47.35	47.87	48.65	47.09	48.13	47.82	0.62
30	2058	C	2	49.22	48.97	49.72	49.47	50.23	49.52	0.48
30	2058	D	1	46.57	46.70	48.26	48.39	46.83	47.35	0.90
30	2058	D	2	49.97	47.45	50.23	47.96	48.71	48.87	1.22
30	2059	D	1	47.35	47.35	47.09	47.87	46.57	47.24	0.47
30	2059	C	1	47.87	47.35	48.39	49.18	47.87	48.13	0.69
30	2059	C	2	47.45	50.23	47.83	48.97	48.71	48.64	1.08
30	2059	D	2	47.71	48.46	47.71	48.46	47.71	48.01	0.41
30	2062	D	2	49.09	49.97	50.23	50.48	50.35	50.02	0.55
30	2062	D	1	49.31	50.48	48.92	49.96	49.18	49.57	0.64

RING	SN	OPER\$	MGAGE	FN(1)	FN(2)	FN(3)	FN(4)	FN(5)	FNAVG	FNSTD
30	2062	C	2	49.97	50.48	50.60	51.49	50.23	50.55	0.57
30	2062	C	1	49.44	50.22	49.05	48.92	49.70	49.46	0.53
30	2067	C	1	47.87	47.87	48.13	49.18	48.92	48.39	0.61
30	2067	D	2	49.09	49.97	48.97	50.23	49.47	49.55	0.55
30	2067	D	1	47.35	48.65	47.61	48.92	49.18	48.34	0.81
30	2067	C	2	50.23	49.72	49.72	50.48	50.23	50.07	0.34
30	2069	C	2	48.71	46.70	47.96	47.96	49.22	48.11	0.95
30	2069	C	1	44.74	46.31	47.09	45.78	47.61	46.31	1.12
30	2069	D	1	45.13	45.65	47.35	47.35	47.74	46.64	1.17
30	2069	D	2	48.46	48.59	49.72	49.22	49.22	49.04	0.52
30	2072	C	1	48.13	48.39	47.35	50.22	47.35	48.29	1.18
30	2072	C	2	49.60	48.97	50.23	50.86	48.71	49.67	0.88
30	2072	D	1	49.05	48	47.35	49.96	48	48.47	1.03
30	2072	D	2	48.84	48.71	48.59	48.97	48.34	48.69	0.24
30	2073	C	1	47.87	48.39	50.22	49.44	48.92	48.97	0.91
30	2073	C	2	49.47	50.48	50.23	49.97	50.23	50.07	0.38
30	2073	D	2	49.22	50.48	50.48	50.86	50.23	50.25	0.62
30	2073	D	1	48.13	48.13	49.05	48.13	49.05	48.50	0.50

Appendix D

Round-Robin Data for Primary FN Standards

Although the calibration data for the NIST gages, shown in Figures 7 to 10, were acceptable, we wished to reduce the error further. In particular, the error trend seen between 0 and 30 FN did not seem random, and so we suspected this was some artifact of our measurement technique or equipment. We sought independent data to learn the source of the errors, and so how they might be reduced.

Our measurement error is the quadrature sum of multiple error sources, such as: operator technique, primary standards, and gage variables. We were already using two gages, two operators, and a large number of standards. Additional data would have to come from sources outside our laboratory, but would have to be compared to it in some way.

We were able to develop this independent data and compare it to our data from Figures 7 to 10, at a special meeting just before the Spring 1999 meeting of the Welding Research Subcommittee on Stainless Steel, which was attended by other researchers in stainless steel. Frank Lake brought the Magne-Gage (identified in this report as gage 3) and coating thickness standards that were regularly used for research by Esab, and Damian Kotecki brought some of his collection of NBS standards, ones that were selected to supplement the areas where our standards were sparse. This allowed us to set up a round robin with three skilled operators (one of which was an NIST operator who contributed to the data in Figures 7 to 10), three Magne-Gages (two from NIST and one from ESAB, which had not been compared to the two NIST gages before), and 51 NBS and NIST coating thickness standards (which were very well distributed through the range of 0 to 120 FN, and which spanned about 50 years of SRM production). Table D.1 lists the data from this round robin. Each standard was measured on three gages. The NIST operator took data with gage 3, while the other two operators took data on the 2 NIST gages.

Figures D.1 to D.3 show the calibration data for the three gages. The small scatter of the data within the error bands indicates that the gages (and operators) have similar accuracies. The data used to calibrate gage 2 was compared with the data collected for the 51 independent primary standards (not shown in Figure D.2). It was evident that a similar calibration would be obtained for gage 2 using either set of primary standards. We think these result indicate that the operators and standards are not significant contributors to the various trends observed in our calibration data (between 0 and 30 FN, Figures 7 to 10). The trends seem to be inherent in the NIST gages, magnets, or the coating thickness-to-FN conversion table in AWS A4.2.

As indicated by the force versus FN plot in Figure D.4, the major differences between the gages evaluated here are due primarily to the different strengths of the magnets used on the gages. The magnet strength clearly affects the slope of the fit, as would be expected. It may also have an influence on the characteristic trends we find in the data for different magnet and gage. Again, this information has little effect for daily users of the technique, but is important to the calibration laboratories that are trying to reduce the error in the test to the achievable minimum.

Table D.1. White-dial and force data for 51 primary FN reference materials measured on 3 Magne-Gages by 3 operators.

Case number	FN	WD1	WD2	WD3	F1	F2
1	2.49	100.50	96.50	114.00	0.52	0.60
2	2.97	98.50	94.00	112.50	0.61	0.71
3	3.45	96.50	92.00	110.00	0.71	0.81
4	4.28	92.50	88.50	107.00	0.91	0.97
5	5.46	88.00	83.00	102.00	1.13	1.22
6	5.64	88.00	83.00	101.00	1.13	1.22
7	6.78	83.00	77.00	96.50	1.38	1.49
8	8.06	78.50	73.50	90.50	1.60	1.65
9	9.49	73.00	68.00	84.50	1.87	1.90
10	9.90	71.00	66.00	82.50	1.97	1.99
11	12.16	62.50	58.00	73.00	2.39	2.36
12	12.20	62.00	57.50	72.00	2.42	2.38
13	14.94	51.50	47.50	60.00	2.94	2.84
14	15.91	46.50	43.00	55.50	3.18	3.04
15	21.17	25.00	19.00	30.50	4.25	4.14
16	21.30	24.50	17.00	30.00	4.27	4.23
17	25.88	8.50	0.0	12.00	5.06	5.01
18	25.98	5.00	-1.00	13.50	5.23	5.06
19	26.07	7.00	-0.50	9.00	5.13	5.03
20	29.16	-5.50	-13.00	-7.50	5.75	5.60
21	32.36	-18.00	-25.50	-17.50	6.37	6.18
22	33.15	-19.50	-28.00	-17.00	6.44	6.29
23	33.32	-22.00	-30.50	-23.00	6.57	6.40
24	34.34	-25.75	-35.00	-28.00	6.75	6.61
25	34.70	-26.25	-38.00	-27.00	6.78	6.75
26	35.63	-29.50	-35.00	-33.00	6.94	6.61
27	40.22	-47.50	-56.00	-52.50	7.83	7.57
28	45.61	-68.00	-75.00	-75.50	8.84	8.44
29	46.87	-70.50	-77.00	-85.00	8.96	8.53
30	47.30	-75.50	-84.00	-88.50	9.21	8.85
31	48.19	-80.00	-87.50	-87.50	9.43	9.01
32	50.23	-84.50	-96.00	-98.50	9.65	9.40
33	50.44	-81.00	-95.00	-96.00	9.48	9.35
34	54.05	-100.00	-109.00	-111.00	10.42	9.99
35	58.26	-113.50	-123.50	-135.50	11.09	10.65
36	60.62	-124.50	-136.00	-138.00	11.63	11.23
37	63.16	-131.00	-144.00	-158.50	11.95	11.59
38	64.08	-136.50	-148.00	-155.50	12.22	11.77
39	67.30	-148.00	-162.00	-176.00	12.79	12.41
40	67.87	-151.00	-164.00	-172.50	12.94	12.50
41	69.23	-155.50	-168.50	-181.50	13.16	12.71
42	71.19	-163.75	-177.50	-197.00	13.57	13.12
43	73.79	-167.00	-188.00	-211.50	13.73	13.60
44	74.20	-171.00	-185.00	-209.50	13.93	13.46
45	76.08		-191.00	-212.50		13.74
46	76.19		-191.00	-210.50		13.74
47	76.30	-182.00	-192.00	-217.00	14.47	13.78
48	81.58	-206.50	-224.00	-248.00	15.68	15.25
49	84.49	-217.00	-236.00	-263.50	16.20	15.80
50	95.98	-264.30	-280.00	-306.50	18.54	17.81
51	97.10	-261.00	-284.00	-321.50	18.37	17.99

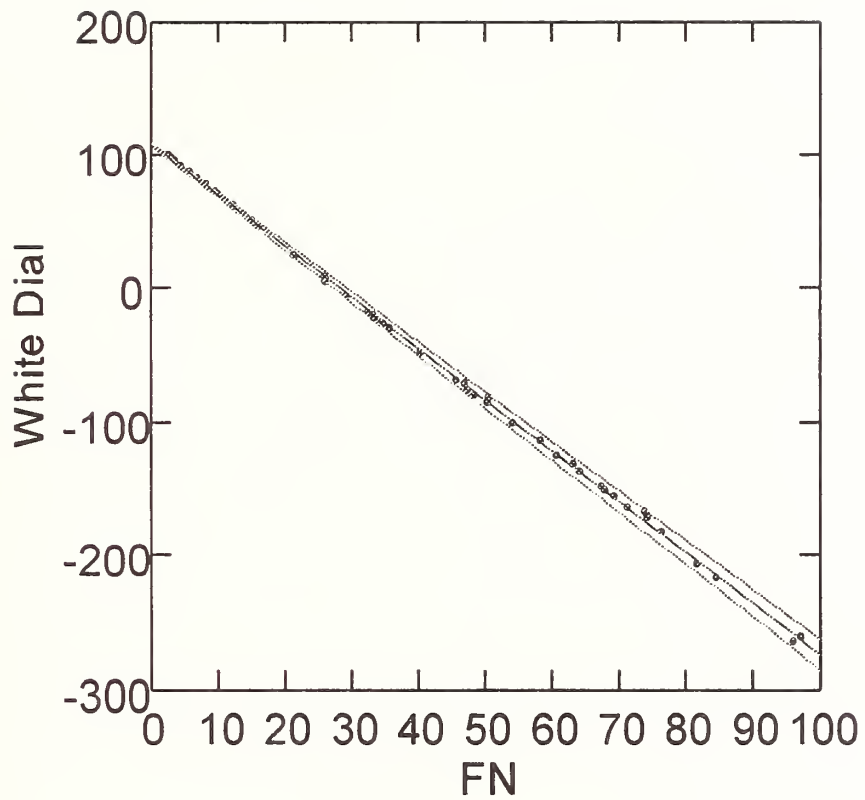

Figure D.1. Data for measurements on gage 1, showing estimated error limits for the primary samples ($\pm 5\%$ of in thickness, expressed in FN).

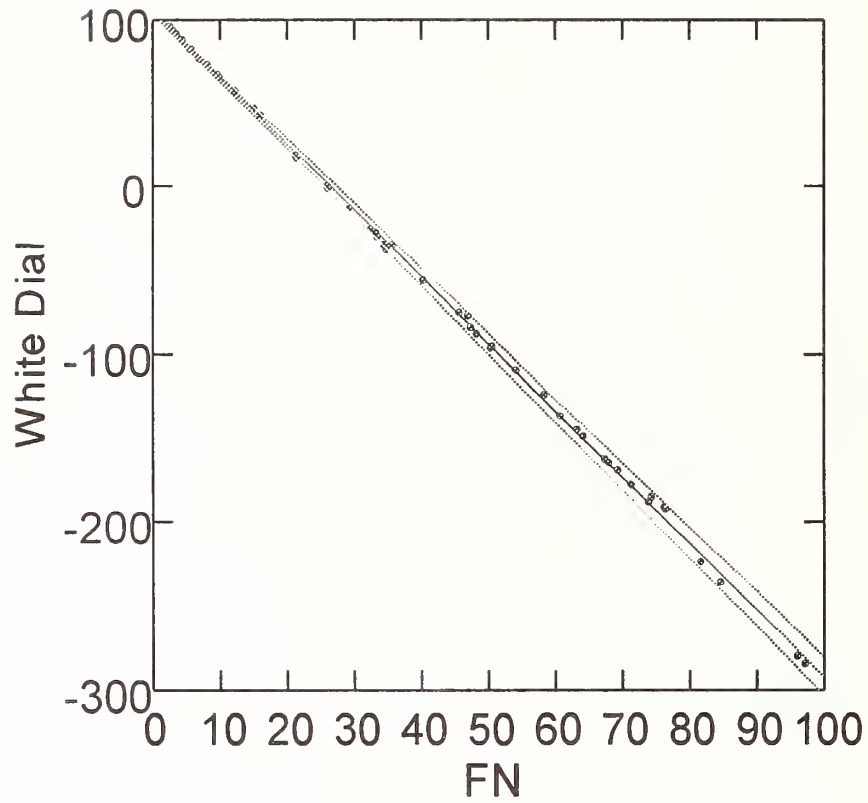

Figure D.2. Primary data for gage 2, with limits estimated for the primary data ($\pm 5\%$ in thickness).

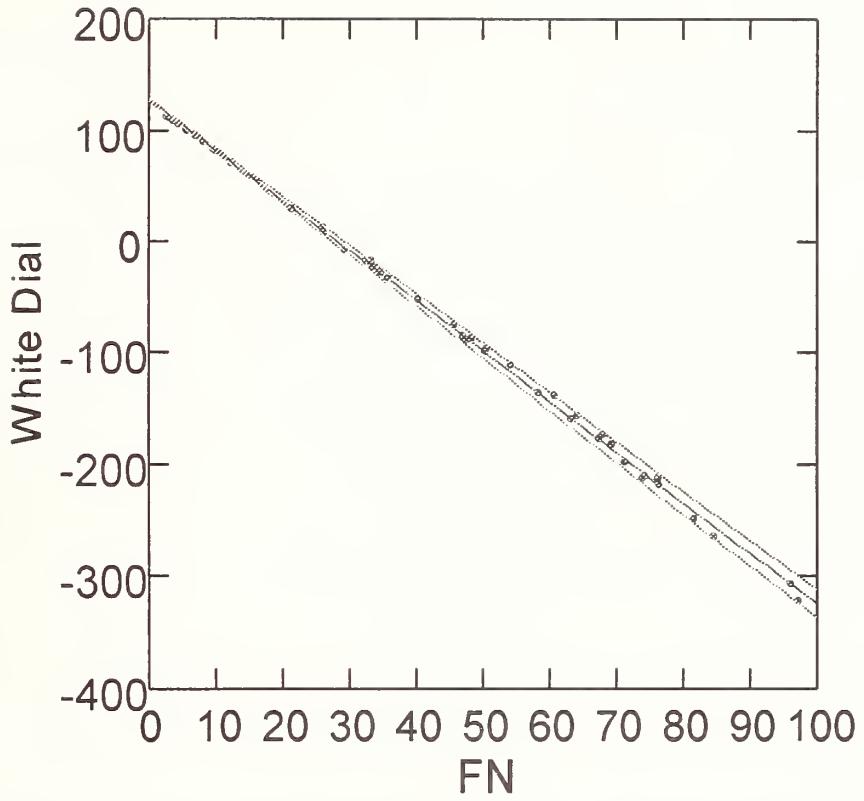

Figure D.3. Data for gage 3, and limits for primary standards ($\pm 5\%$ in thickness).

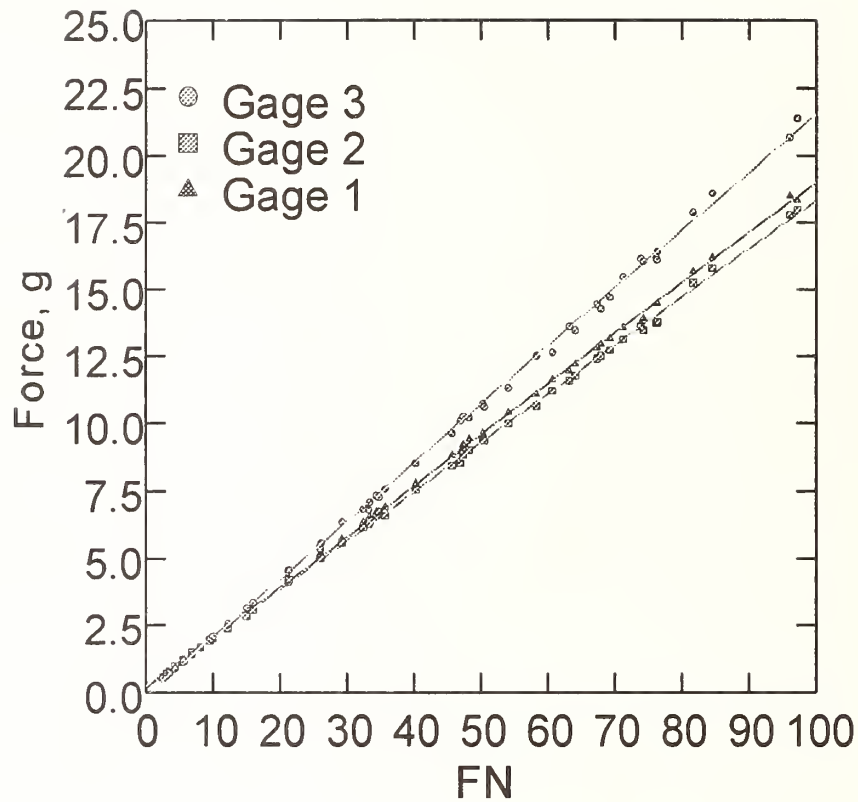

Figure D.4. Force calibration data showing results for all three gages for the 51 primary thickness standards.

$$\text{Gage 1: } FN = -0.75 + 5.3(\text{Force})$$

$$\text{Gage 2: } FN = -1.22 + 5.5(\text{Force})$$

$$\text{Gage 3: } FN = +0.54 + 4.6(\text{Force})$$

NIST Technical Publications

Periodical

Journal of Research of the National Institute of Standards and Technology—Reports NIST research and development in those disciplines of the physical and engineering sciences in which the Institute is active. These include physics, chemistry, engineering, mathematics, and computer sciences. Papers cover a broad range of subjects, with major emphasis on measurement methodology and the basic technology underlying standardization. Also included from time to time are survey articles on topics closely related to the Institute's technical and scientific programs. Issued six times a year.

Nonperiodicals

Monographs—Major contributions to the technical literature on various subjects related to the Institute's scientific and technical activities.

Handbooks—Recommended codes of engineering and industrial practice (including safety codes) developed in cooperation with interested industries, professional organizations, and regulatory bodies.

Special Publications—Include proceedings of conferences sponsored by NIST, NIST annual reports, and other special publications appropriate to this grouping such as wall charts, pocket cards, and bibliographies.

National Standard Reference Data Series—Provides quantitative data on the physical and chemical properties of materials, compiled from the world's literature and critically evaluated. Developed under a worldwide program coordinated by NIST under the authority of the National Standard Data Act (Public Law 90-396). NOTE: The Journal of Physical and Chemical Reference Data (JPCRD) is published bimonthly for NIST by the American Chemical Society (ACS) and the American Institute of Physics (AIP). Subscriptions, reprints, and supplements are available from ACS, 1155 Sixteenth St., NW, Washington, DC 20056.

Building Science Series—Disseminates technical information developed at the Institute on building materials, components, systems, and whole structures. The series presents research results, test methods, and performance criteria related to the structural and environmental functions and the durability and safety characteristics of building elements and systems.

Technical Notes—Studies or reports which are complete in themselves but restrictive in their treatment of a subject. Analogous to monographs but not so comprehensive in scope or definitive in treatment of the subject area. Often serve as a vehicle for final reports of work performed at NIST under the sponsorship of other government agencies.

Voluntary Product Standards—Developed under procedures published by the Department of Commerce in Part 10, Title 15, of the Code of Federal Regulations. The standards establish nationally recognized requirements for products, and provide all concerned interests with a basis for common understanding of the characteristics of the products. NIST administers this program in support of the efforts of private-sector standardizing organizations.

Order the following NIST publications—FIPS and NISTIRs—from the National Technical Information Service, Springfield, VA 22161.

Federal Information Processing Standards Publications (FIPS PUB)—Publications in this series collectively constitute the Federal Information Processing Standards Register. The Register serves as the official source of information in the Federal Government regarding standards issued by NIST pursuant to the Federal Property and Administrative Services Act of 1949 as amended, Public Law 89-306 (79 Stat. 1127), and as implemented by Executive Order 11717 (38 FR 12315, dated May 11, 1973) and Part 6 of Title 15 CFR (Code of Federal Regulations).

NIST Interagency or Internal Reports (NISTIR)—The series includes interim or final reports on work performed by NIST for outside sponsors (both government and nongovernment). In general, initial distribution is handled by the sponsor; public distribution is handled by sales through the National Technical Information Service, Springfield, VA 22161, in hard copy, electronic media, or microfiche form. NISTIR's may also report results of NIST projects of transitory or limited interest, including those that will be published subsequently in more comprehensive form.

U.S. Department of Commerce
National Institute of Standards
and Technology
325 Broadway
Boulder, Colorado 80303-3328

Official Business
Penalty for Private Use \$300