



A11106 053491

NIST
PUBLICATIONS

NIST SPECIAL PUBLICATION **260-123**

U. S. DEPARTMENT OF COMMERCE/Technology Administration
National Institute of Standards and Technology

Standard Reference Materials[®]

Infrared Transmittance Standards —SRMs 2053, 2054, 2055, and 2056

S. G. Kaplan and L. M. Hanssen

QC
100
U57
NO. 260-123
2001
c.2

NIST

National Institute of Standards and Technology
Technology Administration, U.S. Department of Commerce



The National Institute of Standards and Technology was established in 1988 by Congress to “assist industry in the development of technology . . . needed to improve product quality, to modernize manufacturing processes, to ensure product reliability . . . and to facilitate rapid commercialization . . . of products based on new scientific discoveries.”

NIST, originally founded as the National Bureau of Standards in 1901, works to strengthen U.S. industry’s competitiveness; advance science and engineering; and improve public health, safety, and the environment. One of the agency’s basic functions is to develop, maintain, and retain custody of the national standards of measurement, and provide the means and methods for comparing standards used in science, engineering, manufacturing, commerce, industry, and education with the standards adopted or recognized by the Federal Government.

As an agency of the U.S. Commerce Department’s Technology Administration, NIST conducts basic and applied research in the physical sciences and engineering, and develops measurement techniques, test methods, standards, and related services. The Institute does generic and precompetitive work on new and advanced technologies. NIST’s research facilities are located at Gaithersburg, MD 20899, and at Boulder, CO 80303. Major technical operating units and their principal activities are listed below. For more information contact the Publications and Program Inquiries Desk, 301-975-3058.

Office of the Director

- National Quality Program
- International and Academic Affairs

Technology Services

- Standards Services
- Technology Partnerships
- Measurement Services
- Information Services

Advanced Technology Program

- Economic Assessment
- Information Technology and Applications
- Chemistry and Life Sciences
- Materials and Manufacturing Technology
- Electronics and Photonics Technology

Manufacturing Extension Partnership Program

- Regional Programs
- National Programs
- Program Development

Electronics and Electrical Engineering Laboratory

- Microelectronics
- Law Enforcement Standards
- Electricity
- Semiconductor Electronics
- Radio-Frequency Technology¹
- Electromagnetic Technology¹
- Optoelectronics¹

Materials Science and Engineering Laboratory

- Intelligent Processing of Materials
- Ceramics
- Materials Reliability¹
- Polymers
- Metallurgy
- NIST Center for Neutron Research

Chemical Science and Technology Laboratory

- Biotechnology
- Physical and Chemical Properties²
- Analytical Chemistry
- Process Measurements
- Surface and Microanalysis Science

Physics Laboratory

- Electron and Optical Physics
- Atomic Physics
- Optical Technology
- Ionizing Radiation
- Time and Frequency¹
- Quantum Physics¹

Manufacturing Engineering Laboratory

- Precision Engineering
- Manufacturing Metrology
- Intelligent Systems
- Fabrication Technology
- Manufacturing Systems Integration

Building and Fire Research Laboratory

- Applied Economics
- Structures
- Building Materials
- Building Environment
- Fire Safety Engineering
- Fire Science

Information Technology Laboratory

- Mathematical and Computational Sciences²
- Advanced Network Technologies
- Computer Security
- Information Access
- Convergent Information Systems
- Information Services and Computing
- Software Diagnostics and Conformance Testing
- Statistical Engineering

¹At Boulder, CO 80303.

²Some elements at Boulder, CO.

NIST Special Publication 260-123

Standard Reference Materials[®]

Infrared Transmittance Standards —SRMs 2053, 2054, 2055, and 2056

S. G. Kaplan

L. M. Hanssen

Optical Technology Division

Physics Laboratory

Gaithersburg, MD 20899-8442



U.S. DEPARTMENT OF COMMERCE, *Donald L. Evans, Secretary*
NATIONAL INSTITUTE OF STANDARDS AND TECHNOLOGY, *Karen H. Brown, Acting Director*

Issued May 2001

Certain commercial equipment, instruments, or materials are identified in this paper in order to specify the experimental procedure adequately. Such identification is not intended to imply recommendation or endorsement by the National Institute of Standards and Technology, nor is it intended to imply that the materials or equipment identified are necessarily the best available for the purpose.

National Institute of Standards and Technology Special Publication 260-123
Natl. Inst. Stand. Technol. Spec. Publ. 260-123, 23 pages (May 2001)
CODEN: NSPUE2

U.S. GOVERNMENT PRINTING OFFICE
WASHINGTON: 2001

For sale by the Superintendent of Documents, U.S. Government Printing Office
Internet: bookstore.gpo.gov — Phone: (202) 512-1800 — Fax: (202) 512-2250
Mail: Stop SSOP, Washington, DC 20402-0001

**Standard Reference Materials:
Infrared Transmittance Standards—SRMs 2053, 2054, 2055, and 2056**

Table of Contents

Abstract	1
1. Introduction	2
2. Material Preparation and Instructions for Use.....	3
3. Theory of Transmittance for Thin Film Filters	5
4. Measurement Techniques and Instrumentation.....	8
5. Effects of Temperature and Spatial Non-Uniformity.....	10
6. Determination of Uncertainty in Transmittance.....	13
7. Summary	19
8. Acknowledgements	20
Certificate, SRM 2053, Infrared Transmittance Standard.....	23
Certificate, SRM 2054, Infrared Transmittance Standard.....	29
Certificate, SRM 2055, Infrared Transmittance Standard.....	35
Certificate, SRM 2056, Infrared Transmittance Standard.....	41

Standard Reference Materials:

Infrared Transmittance Standards – SRMs 2053, 2054, 2055, and 2056

S. G. Kaplan and L. M. Hanssen

Optical Technology Division

Physics Laboratory

National Institute of Standards and Technology

Gaithersburg, MD 20899

ABSTRACT

Standard Reference Materials 2053, 2054, 2055, and 2056 are transmission filters designed to have nominally neutral attenuation over the 2 μm to 25 μm wavelength region, with optical densities near 1, 2, 3, and 4, respectively. The filters are made of polished single-crystal Si substrates, 25 mm in diameter and 0.25 mm in thickness, with thin Ni:Cr or Cu:Ni coatings appropriate for the given attenuation level. They are intended to be used for checking the accuracy of the ordinate scale of infrared spectrophotometers. The regular spectral transmittance of each filter has been measured with 8 cm^{-1} resolution using an FT-IR spectrophotometer. The uncertainty in transmittance of each filter has been determined, including both type-A (statistical) and type-B (systematic) components.

Keywords: attenuation; FT-IR spectrophotometer; infrared filter; optical density; transmittance; uncertainty analysis

1. Introduction

Historically, NIST has developed extensive high-accuracy spectrophotometry instrumentation and provided U.S. industry with a variety of Standard Reference Materials (SRMs) and Calibration Services covering ultraviolet, visible, and near-infrared wavelengths [1-4]. These include both regular transmittance and reflectance of specular materials, and measurements of diffuse materials in particular geometries [5]. Equivalent standards and services covering the thermal infrared spectral region have been much sparser, in part because of the traditionally smaller demand for them, as well as the technical difficulties in establishing reliable scales at these longer wavelengths. However, one standard which has been quite popular is SRM 1921, a polystyrene transmission wavelength standard covering the 2 μm to 18 μm wavelength region [6]. The wide use of infrared spectrophotometry in chemical identification and analysis has led to the need for wavelength calibration standards.

With the increasing use of Fourier-Transform infrared (FT-IR) spectrophotometers for quantitative as well as qualitative analysis of a wide variety of materials and optical components, the need has grown for standard materials to test or verify the ordinate scale accuracy of the instruments. Though FT-IR spectrophotometers provide good spectral resolution, signal-to-noise ratio, and measurement repeatability, they are subject to more complex sources of error than are traditional dispersive-based systems [7]. While different types of measurements and samples will emphasize different sources of error, an important check of the baseline ordinate accuracy can be obtained by measuring the transmittance of a neutral filter with an attenuation level similar to the sample of interest.

A new set of Standard Reference Materials, SRMs 2053, 2054, 2055, and 2056, have been produced. They are intended for use in checking the ordinate scale accuracy of infrared spectrophotometers for regular transmittance measurements. Each SRM is a transmission filter consisting of a thin Ni:Cr or Cu:Ni coating on a 25 mm diameter, 0.25 mm thick polished single-crystal Si substrate. The coatings are designed to produce neutral attenuation over the 2 μm to 25 μm (2053, 2054, and 2055) or 2 μm to 20 μm (2056) wavelength region for optical densities ($\text{OD} \equiv -\log_{10}(T)$, where T is the transmittance) near 1, 2, 3, or 4. This special publication discusses in detail the measurement theory and instrumentation, material preparation, and uncertainty determination for the certification of these standard reference materials.

2. Material Preparation and Instructions for Use

These transmission filters consist of thin metallic alloy coatings on single-crystal double-side polished <100> Si substrates. The metallic coatings were deposited by Luxel Corporation* of Friday Harbor, WA, while the Si substrates were supplied by Virginia Semiconductor, Inc., of Fredericksburg, VA. The 250 μm thick, 25 mm diameter substrates were specified to be parallel to within 1 μm , and have a resistivity greater than 20 Ω/cm . The metallic layers are overcoated with a thin (≈ 20 nm) layer of SiO to protect them from oxidation. Table I lists the nominal optical density levels and coating thicknesses for the different SRMs, while Figure 1 shows a plot of the transmittances versus wavelength for a representative filter from each set. The Ni:Cr films were grown from a Ni:Cr evaporation source, while the Cu:Ni films were grown by co-depositing Cu and Ni from separate sources. In both cases an ion-beam was used to improve the density and structure of the deposited films. More details of the coating design have been given previously [8, 9].

Each SRM 2053 through 2056 is stored in a special container to minimize degradation of the surfaces of the filter. The plastic wafer tray holds the sample securely, while the outer anodized aluminum box protects the sample holder and clearly identifies each filter. When not in use, the filter should be kept in its protective box, preferably in a dessicator cabinet if available. The SRMs are quite fragile and should be handled only by the edge, with clean plastic or thin rubber gloves. The surfaces should never be touched. Dust can be removed by gently blowing the surface with clean, dry air.

SRM NUMBER	NOMINAL OD LEVEL	FILM COMPOSITION AND THICKNESS	ACTUAL OD RANGE FROM 2 μm TO 25 μm
2053	1	20 nm Ni:Cr	0.95-1.05
2054	2	90 nm Ni:Cr	1.8-2.2
2055	3	77 nm Cu:Ni	2.95-3.2
2056	4	97 nm Cu:Ni	4.0-4.5

Table I. Nominal OD levels, film composition and thicknesses, and actual spectral OD ranges from 2 μm to 25 μm wavelength for the four SRM filter sets described in this document.

* The use of a trade name or company name is for identification only and does not imply endorsement by the National Institute of Standards and Technology, nor does it imply that the material or product identified are necessarily the best available for the purpose.

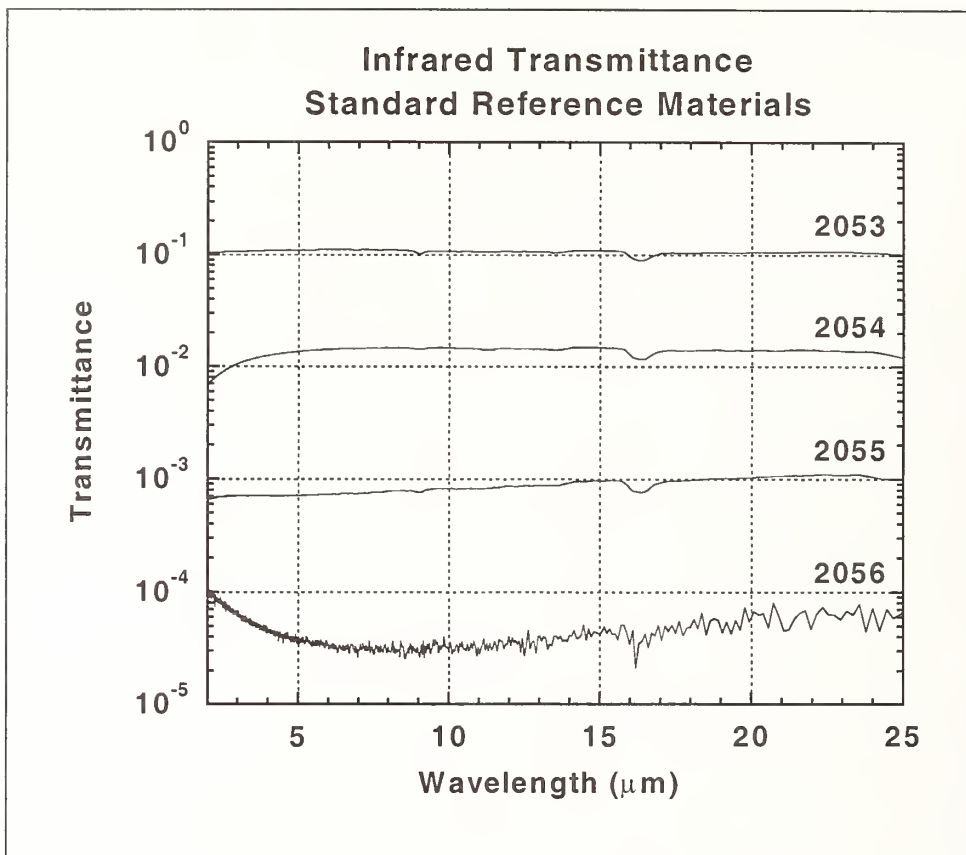

Figure 1. Transmittance versus wavelength of representative samples from the four SRM filters described in this publication. The 2053 and 2054 filters are Ni:Cr coatings on Si, while the 2055 and 2056 filters are Cu:Ni coatings on Si. The films provide fairly neutral attenuation over the 2 μm to 25 μm wavelength region; absorption features at 9 μm and 16 μm are due to the 0.25 mm thick Si substrates.

Only the central 10 mm diameter portion of the filter should be used in the transmittance measurements. If possible the spectrophotometer beam should be centered on the sample. The certified transmittance values and associated uncertainties are intended to be correct for normally incident light. In practice, the values will be valid for an unpolarized beam with f/3 or slower geometry, where the central ray is within 2° of the sample normal. For larger angles of incidence, or polarized beams, the transmittance values will change.

If possible the spectral resolution of the instrument should be set to 8 cm^{-1} , which was that used in the calibration measurements. At higher resolution (smaller value in cm^{-1}) Fabry-Perot fringes will appear in the spectrum because of interference in the substrate. At lower resolution, some of the spectral features (notably the prominent Si substrate absorption peaks at 9 μm and 16 μm) will broaden. The filter temperature should be between 20°C and 30°C during the measurements.

3. Theory of Transmittance for Thin Film Filters

The transmittance of a thin metallic layer on an optically thick substrate for TE polarization, T_{TE} , can be calculated from the following formulas [10, 11]:

$$t_{1fTE} := \frac{2 \cdot n_1 \cdot \cos(\theta_1)}{n_1 \cdot \cos(\theta_1) + n_f \cdot \cos(\theta_f)} \quad (1)$$

$$r_{f1TE} := -\frac{n_1 \cdot \cos(\theta_1) - n_f \cdot \cos(\theta_f)}{n_1 \cdot \cos(\theta_1) + n_f \cdot \cos(\theta_f)} \quad (2)$$

$$t_{f2TE} := \frac{2 \cdot n_f \cdot \cos(\theta_f)}{n_2 \cdot \cos(\theta_2) + n_f \cdot \cos(\theta_f)} \quad (3)$$

$$r_{2fTE} := \frac{n_2 \cdot \cos(\theta_2) - n_f \cdot \cos(\theta_f)}{n_2 \cdot \cos(\theta_2) + n_f \cdot \cos(\theta_f)} \quad (4)$$

$$r_{f2TE} := -r_{2fTE} \quad (5)$$

$$\beta := \frac{2 \cdot \pi}{\lambda} \cdot n_f \cdot d_f \cdot \cos(\theta_f) \quad (6)$$

$$T_{12TE} := \operatorname{Re} \left(\frac{n_2 \cdot \cos(\theta_2)}{n_1 \cdot \cos(\theta_1)} \cdot \left\| \frac{t_{1fTE} \cdot t_{f2TE} \cdot \exp(i \cdot \beta)}{1 - r_{f1TE} \cdot r_{f2TE} \cdot \exp(2 \cdot i \cdot \beta)} \right\|^2 \right) \quad (7)$$

$$R_{21TE} := \left\| \frac{r_{2fTE} + r_{f1TE} \cdot \exp(2 \cdot i \cdot \beta)}{1 - r_{f2TE} \cdot r_{f1TE} \cdot \exp(2 \cdot i \cdot \beta)} \right\|^2 \quad (8)$$

$$T_{23TE} := \operatorname{Re} \left(\frac{n_3 \cdot \cos(\theta_3)}{n_2 \cdot \cos(\theta_2)} \cdot \left\| \frac{2 \cdot n_2 \cdot \cos(\theta_2)}{n_2 \cdot \cos(\theta_2) + n_3 \cdot \cos(\theta_3)} \right\|^2 \right) \quad (9)$$

$$R_{32TE} := \left\| \frac{n_2 \cdot \cos(\theta_2) - n_3 \cdot \cos(\theta_3)}{n_2 \cdot \cos(\theta_2) + n_3 \cdot \cos(\theta_3)} \right\|^2 \quad (10)$$

$$\alpha := \frac{4 \cdot \pi}{\lambda} \cdot \operatorname{Im}(n_2 \cdot \cos(\theta_2)) \quad (11)$$

$$T_{TE} := \frac{T_{12TE} \cdot T_{23TE} \cdot \exp(-\alpha \cdot d_2)}{1 - R_{21TE} \cdot R_{32TE} \cdot \exp(-2 \cdot \alpha \cdot d_2)} \quad (12)$$

For TM polarization, the following equations are used:

$$t_{1fTM} := \frac{2 \cdot n_1 \cdot \cos(\theta_1)}{n_f \cdot \cos(\theta_1) + n_1 \cdot \cos(\theta_f)} \quad (13)$$

$$r_{f1TM} := -\frac{n_f \cdot \cos(\theta_1) - n_1 \cdot \cos(\theta_f)}{n_f \cdot \cos(\theta_1) + n_1 \cdot \cos(\theta_f)} \quad (14)$$

$$t_{f2TM} := \frac{2 \cdot n_f \cdot \cos(\theta_f)}{n_f \cdot \cos(\theta_2) + n_2 \cdot \cos(\theta_f)} \quad (15)$$

$$r_{2fTM} := \frac{n_f \cdot \cos(\theta_2) - n_2 \cdot \cos(\theta_f)}{n_f \cdot \cos(\theta_2) + n_2 \cdot \cos(\theta_f)} \quad (16)$$

$$r_{f2TM} := -r_{2fTM} \quad (17)$$

$$T_{12TM} := \operatorname{Re} \left(\frac{n_2 \cdot \cos(\theta_2)}{n_1 \cdot \cos(\theta_1)} \cdot \left(\frac{t_{1fTM} \cdot t_{f2TM} \cdot \exp(i \cdot \beta)}{1 - r_{f1TM} \cdot r_{f2TM} \cdot \exp(2 \cdot i \cdot \beta)} \right) \right)^2 \quad (18)$$

$$R_{21TM} := \left(\frac{r_{2fTM} + r_{f1TM} \cdot \exp(2 \cdot i \cdot \beta)}{1 - r_{f2TM} \cdot r_{f1TM} \cdot \exp(2 \cdot i \cdot \beta)} \right)^2 \quad (19)$$

$$T_{23TM} := \operatorname{Re} \left(\frac{n_3 \cdot \cos(\theta_3)}{n_2 \cdot \cos(\theta_2)} \cdot \left(\frac{2 \cdot n_2 \cdot \cos(\theta_2)}{n_3 \cdot \cos(\theta_2) + n_2 \cdot \cos(\theta_3)} \right) \right)^2 \quad (20)$$

$$R_{32TM} := \left(\frac{n_3 \cdot \cos(\theta_2) - n_2 \cdot \cos(\theta_3)}{n_3 \cdot \cos(\theta_2) + n_2 \cdot \cos(\theta_3)} \right)^2 \quad (21)$$

$$T_{TM} := \frac{T_{12TM} \cdot T_{23TM} \cdot \exp(-\alpha \cdot d_2)}{1 - R_{21TM} \cdot R_{32TM} \cdot \exp(-2 \cdot \alpha \cdot d_2)} \quad (22)$$

Here n_1 , n_f , n_2 , and n_3 are the complex refractive indices of the incident medium, film, substrate, and exit medium, respectively. (We take $n_1=n_3=1$ for air.) The incident angle at the first surface is θ_1 , and the remaining angles θ_f , θ_2 , and θ_3 are given by the complex form of Snell's Law, $n_i \sin(\theta_i) = n_1 \sin(\theta_1)$. These equations treat the wave in the metal film coherently, but the wave in the substrate incoherently, an appropriate approximation for the low-resolution spectral data, free from Fabry-Perot fringes, supplied with these SRMs.

The complex index of refraction of the film, $n_f(\omega)$, along with the film thickness d_f , determines the transmittance level for the filters. The index of refraction is in turn a function of the complex ac conductivity $\sigma_f(\omega)$ of the film material:

$$n_f(\omega) = \sqrt{\varepsilon_\infty + \frac{4\pi i \sigma_f(\omega)}{\omega}} \quad (23)$$

Here ε_∞ is the high-frequency dielectric screening constant contribution from electronic transitions in the metallic ions.

The functional form of the ac conductivity of the metallic alloys is highly dependent on the composition and structure of the films. In general, the behavior has been found to be non-Drude-like at high frequencies [12]. The alloy compositions and film thicknesses for the four different optical density levels were largely determined by trial and error, using Eqs. (1-22) as a guide in modeling the transmittances. The resulting spectra all have less than 0.8 OD variation over the 2 μm to 25 μm wavelength range. The filters attenuate mostly by reflection, especially for the higher OD levels.

Eqs. (1-22) can also be used to model the incident beam geometry dependence of the filter transmittances. The sensitivity to incident angle is quite small, especially for unpolarized light, or light with a conical focussing geometry. Figure 2 shows the predicted TE and TM polarized transmittances from 0° to 10° for an OD 1 filter at a wavelength of 10 μm , relative to the normal incidence transmittance. The approximately $\pm 2\%$ change in transmittance at 10° is fairly insensitive to wavelength and film thickness and depends mainly on the Si substrate. For an f/3 focussed geometry at near-normal incidence (corresponding to the geometry in our FT-IR instrument) the two polarization modes are effectively averaged, leading to a small residual effect of 0.1% to 0.2% due to a slight (5%) degree of polarization of the beam. The effects of path length change in the Si substrate at wavelengths where the Si is absorbing, lead to a maximum change in transmittance for the f/3 geometry versus normal plane wave illumination on the order of 0.05%.

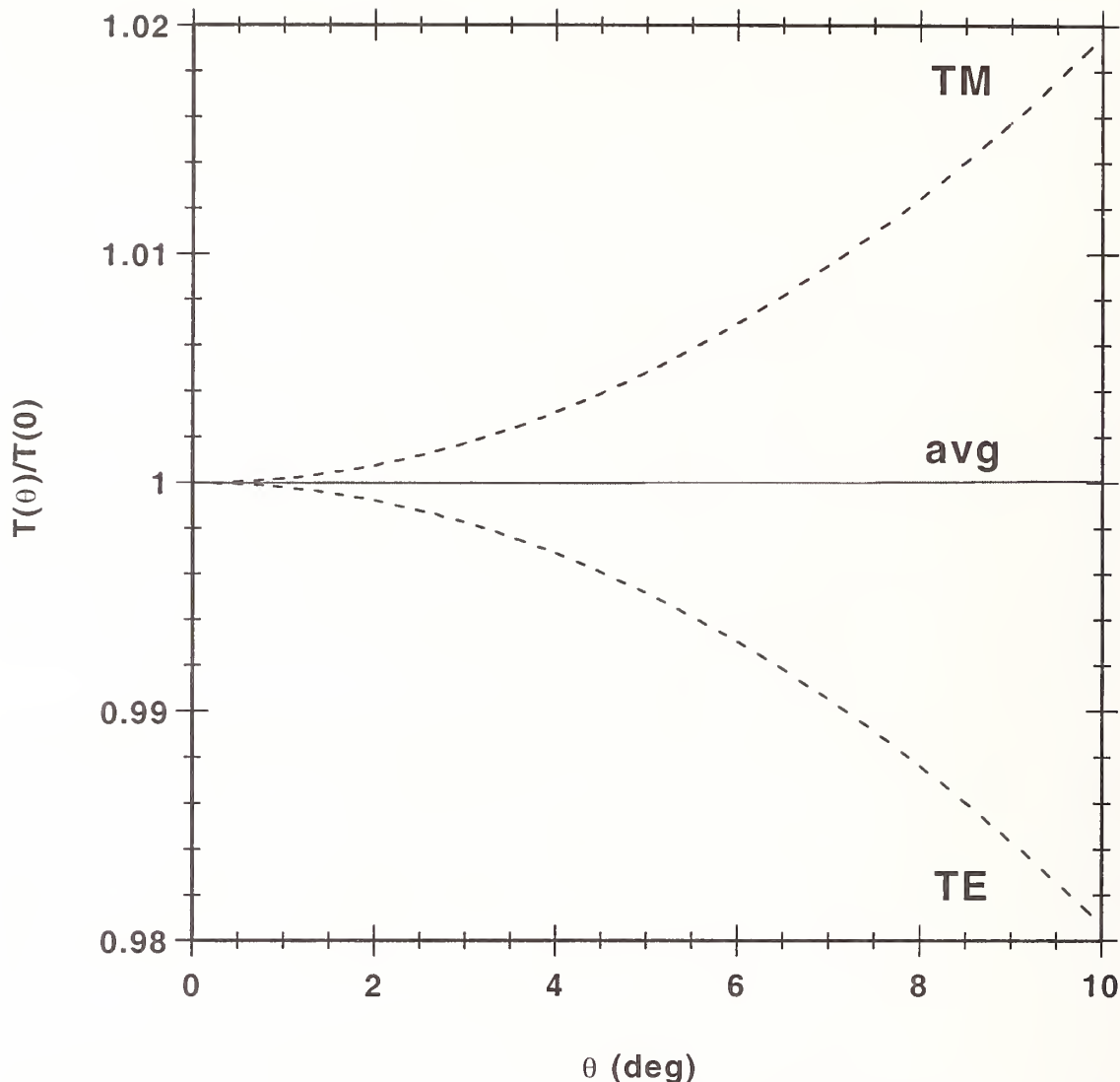

Figure 2. Simulated change in transmittance of an OD1 filter on Si versus incident angle for TE- and TM-polarized light (dashed lines) and average (solid line) for a wavelength of $10\ \mu\text{m}$. The changes in transmittance for the two polarization modes average out to a very small residual effect for unpolarized radiation.

4. Measurement Techniques and Instrumentation

The measurement setup is shown in Figure 3. A Bio-Rad FTS-60A FT-IR spectrophotometer configured with a ceramic-coated globar source, a KBr:Ge beamsplitter, and a room-temperature pyroelectric detector was used for the 2053, 2054, and 2055 (OD 1, 2, and 3) filter measurements, covering the $2\ \mu\text{m}$ to $25\ \mu\text{m}$ spectral range. A Bomem DA3 FT-IR spectrophotometer with a 77 K mercury-cadmium telluride photoconductive detector was used for the 2056 (OD 4) measurements, covering the $2\ \mu\text{m}$ to $20\ \mu\text{m}$ spectral range. Both systems were modified by adding half beam-blocks before and after the sample position to eliminate inter-reflections involving the interferometer, sample, and detector, as

has been described previously [13]. Also, a field stop was placed in the sample compartment before the sample position in order to reduce the effects of thermal emission from the source aperture of the instrument. The temperature in the Bio-Rad sample compartment was 29 °C, and 24 °C in the Bomem sample compartment. Both instruments were purged with dry, CO₂-free air.

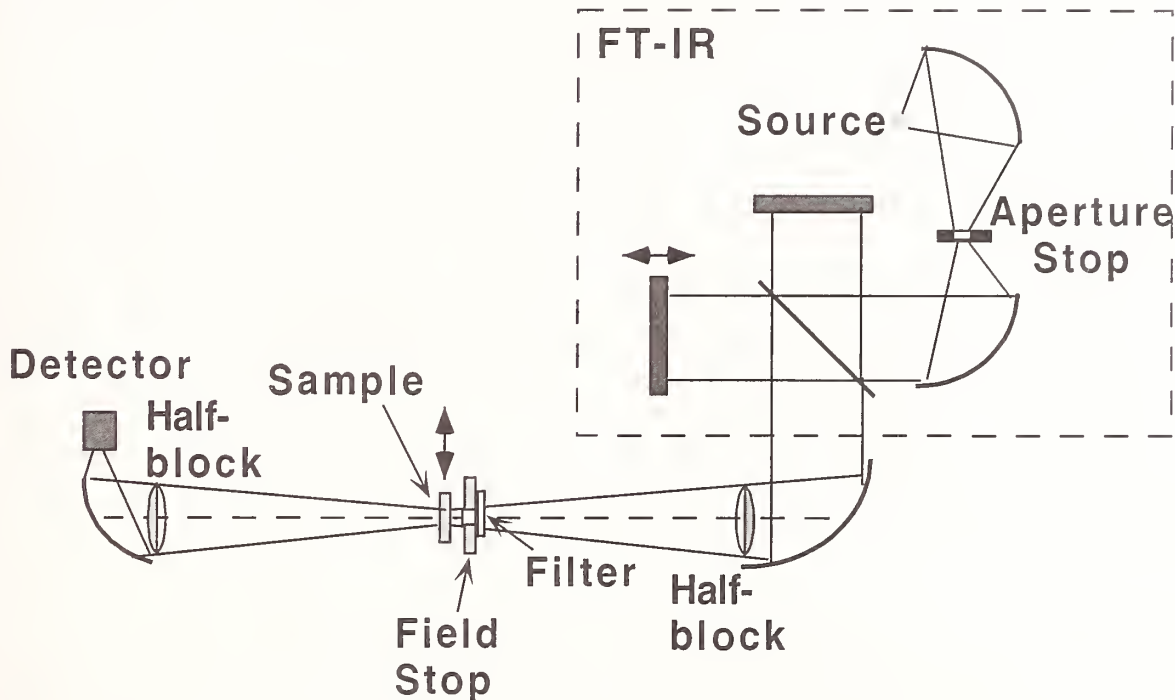

Figure 3. Schematic optical layout for the transmittance measurements of the neutral density filters. The FT-IR spectrometer is modified with the addition of half-beam blocks, a field stop near the sample position, and additional filtering as described in the text, in order to eliminate major sources of radiometric error.

The transmittance measurements of the 2053 filters were performed using an empty beam path as the reference. The incident flux was reduced by placing an \approx OD 1 filter on the field stop, in order to linearize the detector response. The source aperture of the instrument was set to 2 mm, with an \approx f/1 collection geometry, which is transformed in the sample compartment to a \approx 6 mm diameter spot at the sample location, with an f/3 focussing geometry. The filter transmittance was calculated as

$$T = \frac{I(\text{filter})}{I(\text{empty})} \quad (24)$$

where $I(\text{filter})$ and $I(\text{empty})$ are the spectra obtained with the sample and blank in place, respectively. The 2054 and 2055 filters (OD 2 and OD 3) were measured

using a 2053 filter as a reference, with the additional filter on the field stop removed, and the transmittance was calculated as

$$T = \frac{I(\text{filter})}{I(\text{reference})} * T(\text{reference}) \quad (25)$$

where $I(\text{reference})$ is the spectrum recorded with the 2053 filter in place. The 2056 filters were measured using a 2054 filter (OD 2) as a reference, again using Eq. 25 to calculate the filter transmittances. The spot size on the 2056 filters was 5 mm in diameter, with an f/4 focussing geometry.

The sample and reference spectra were recorded with 8 cm⁻¹ resolution, using either Hamming or Happ-Ganzel apodization. Each measurement consisted of an average of from 64 to 4096 scans, giving a total measurement time ranging from several minutes to approximately 1 hour. The measurements were repeated several times in succession, alternately moving the sample or reference into the beam path. Measurements on a subset of the filters were then repeated approximately 6 months later, after removing and remounting the filters in the spectrophotometer. These sets of measurements were analyzed to estimate uncertainty components for repeatability and reproducibility, as discussed in section 6. The average of all the measurements on a given filter was used for the calibrated transmittance value for that filter.

5. Effects of Temperature and Spatial Non-Uniformity

In addition to uncertainties in transmittance due to the measurement process itself, the effects of temperature and non-uniformity in the filter coatings needs to be investigated in order to certify the transmittance of the filters. These effects were investigated for a subset of filters from each SRM set in order to estimate uncertainty components due to temperature dependence and spatial non-uniformity.

(1) Temperature Dependence

The transmittance of the filters is expected to be only weakly temperature dependent near room temperature. The ac conductivity of the films and the absorption coefficient of the Si substrate both change with temperature. The near-ambient temperature dependence was tested by mounting one filter from each set in an optical access cryostat and measuring the transmittances at 298 K and 308 K. These data are shown in Figure 4. Each measurement was performed twice, and the drift between successive measurements was on the order of 0.2 %. Within this uncertainty due to non-repeatability of the measurements, there is no observed temperature dependence. Any temperature dependence is expected to be linear near room temperature. In order to certify the transmittances of these

filters over the 20 °C to 30 °C temperature range, we take 0.2% as the uncertainty component due to temperature dependence.

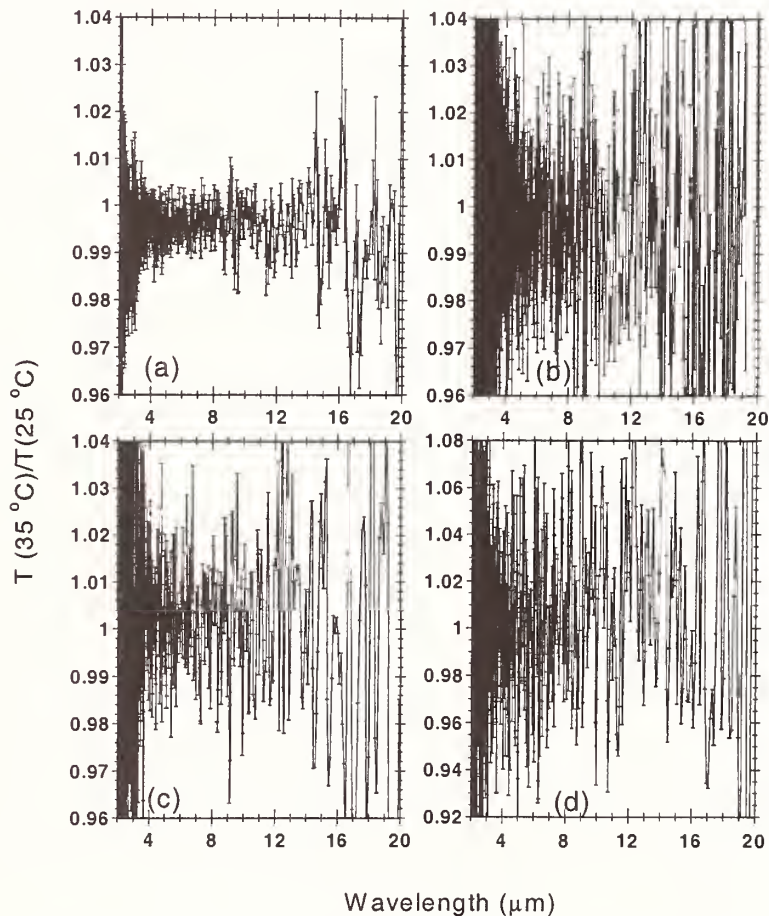

Figure 4. Measured near-ambient (25 °C to 35 °C) temperature dependence of the transmittance of a representative filter from (a) SRM 2053, (b) SRM 2054, (c) SRM 2055, (d) SRM 2056. Within the uncertainty due to drift in the spectrometer between measurements, we did not observe any change in transmittance over this temperature range.

(2) Spatial Non-Uniformity

The certified transmittance values were obtained using a 5 mm or 6 mm diameter spot located at the center of each sample. The transmittance of each filter is in fact non-uniform because of gradients in the thickness of the metallic films. These gradients are a result of the vacuum deposition process, and are

typically less than 1 % of the thickness across the face of the sample. However, for the higher OD levels, this can lead to a large variation in transmittance. In order to assess the transmittance uncertainty component due to spatial variation, we selected two filters at random from each set of 10 and measured the transmittance with a 3 mm spot at five different locations on the sample, as shown in Figure 5.

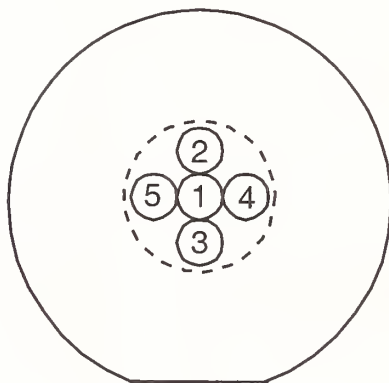

Figure 5. Diagram of the five spots on each sample measured to estimate the spatial uniformity of the transmittance. The beam diameter was nominally 3 mm, and was moved ± 3.5 mm from the center of the sample in two perpendicular directions.

Figure 6 shows the ratio of the transmittance measured at points 2 through 5 on four samples to the transmittance measured at the center (point #1). As can be seen from this figure, the non-uniformity is on the order of 0.5 % to 0.7 % for the OD 1 and OD 2 filters, but 3 % to 4 % for the OD 3 and OD 4 filters. The thickness gradient appears to be fairly uniform over each sample, so a standard uncertainty component was derived by taking the maximum observed deviation from the center transmittance and dividing by $\sqrt{3}$. Since all 10 filters in each set were produced in the same deposition run, and mounted on rotating platters during the deposition, it is expected that they will have similar thickness and composition gradients.

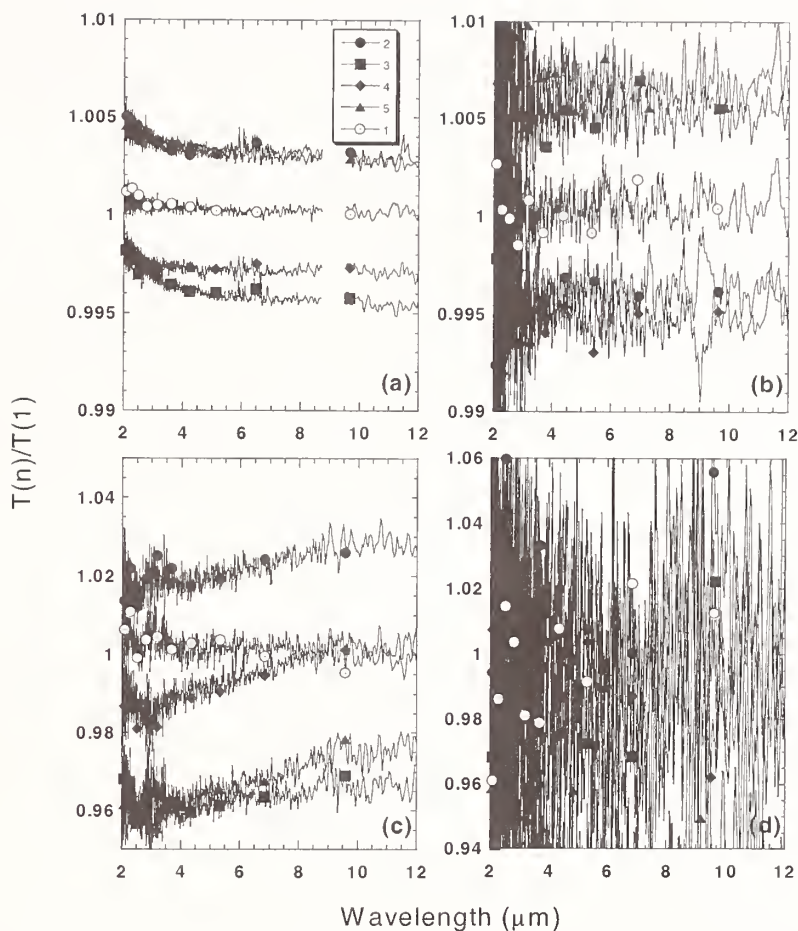

Figure 6. Measured spatial uniformity of a representative filter from (a) SRM 2053, (b) SRM 2054, (c) SRM 2055, and (d) SRM 2056. The ratio of the transmittance at a given position to that at the center is plotted for the five positions indicated in Figure 5. The non-uniformity over the central 10 mm diameter is on the order of 0.5 % for 2053 and 2054, and 3 % to 4 % for 2055 and 2056.

6. Determination of Uncertainty in Transmittance

The combined uncertainty in transmittance for each filter consists of a number of systematic components, evaluated by Type-B methods, as well as statistical components, evaluated by Type-A methods [14]. In addition to the spatial non-uniformity and temperature dependence components described above, there are a number of other potential sources of error in the measurement process. Most of these effects have been discussed before [13] in the context of transmittance measurements on ultra-thin (100 nm thickness) neutral density filters. Here we briefly discuss the major radiometric error sources for the filter transmittance measurements and give estimates for the standard uncertainty components associated with each one.

1. *Interreflections*

Interreflections involving the interferometer, sample, and detector are potentially a large source of radiometric error. The half beam blocks mentioned in section 4 eliminate most of the interreflected flux components, but we estimate a 0.2 % to 0.3 % residual effect may remain, depending on the reflectance of the filter.

2. *Detector nonlinearity*

Care was taken to ensure that the detectors used for the transmittance measurements were operating in a linear regime, by successively attenuating the beam and looking for changes in apparent transmittance. Also, the spurious signal at wavenumbers lower than the detector or beamsplitter cutoff frequency was observed and found to be on the order of 10^{-4} to 10^{-3} of the peak single-beam signal. While no effects of nonlinearity were directly observed for the neutral-density filters, some false harmonic signals were observed for narrow-band filters under similar measurement conditions. We take 0.05 % to 0.1 % as standard uncertainty components due to detector nonlinearity.

3. *Detector nonequivalence*

This effect was clearly observable using the pyroelectric detector with the unattenuated (≈ 50 mW) beam from the interferometer, which yielded as much as a 3 % error in transmittance due to the change in detector temperature between the sample and reference measurements. However, by limiting the change in flux on the detector, this effect was reduced, leaving an estimated uncertainty component of 0.1 % to 0.2 %.

4. *Non-source emission*

Emitted flux from the source aperture can overflow the sample and cause errors in the transmittance measurement. This effect was reduced by placing the field stop in front of the sample, as shown in Fig. 3. Also, emission from the sample can be modulated by the interferometer and collected by the detector, yielding an error in measured transmittance. This effect was unobservable with the pyroelectric (room temperature) detector, and less than 0.1 % with the 77 K HgCdTe detector used for the OD4 measurements. The estimated uncertainty component for non-source emission is 0.15 %.

5. *Beam nonuniformity*

The interaction between the beam and sample nonuniformity leads to an averaging of the sample transmittance with unknown spatial weighting and thus contributes to uncertainty in the actual transmittance level. This effect was tested by flipping the sample over without repositioning it in the beam, and is estimated to contribute a standard uncertainty component of 0.2 %.

6. *Beam displacement, deviation, and focus shift*

The SRM filters are only 0.25 mm thick, with the maximum angle of incidence in the $f/3$ beam about 9.5° . Effects of the sample on the beam geometry were tested by rotating or tilting the sample, as well as looking at effects of optically thicker samples. The uncertainty component due to these effects is estimated at 0.1 %.

7. *Beam geometry and polarization*

As discussed in section 3, the effects of the difference of the measurement geometry from ideal normal-incidence plane wave irradiation are small due to the small angles (less than 9.5°) and small degree of polarization of the beam (less than 5 %). Also, the effects of path length change in the Si substrate due to off-axis rays is small because of the small absorption level (less than 20 %) and large index of refraction (≈ 3.4) of Si. The uncertainty component due to these geometric considerations is estimated at 0.2 %.

8. *Sample vignetting*

This was tested by placing a blank aperture of the same size as the sample in the beam path and measuring its transmittance. Some residual effects from source aperture radiation or scattered light from other parts of the instrument not rejected by the field stop yield an uncertainty estimate of 0.03 % for sample vignetting.

9. *Sample scattering*

The total integrated scatter from a sample was measured using an infrared integrating sphere. No signal was observed above the 0.02 % threshold of the measurement, and we take this as a conservative uncertainty component estimate due to sample scattering.

10. *Phase errors*

Errors in the calculated phase spectrum can produce large errors in the transmittance spectrum. In general, the phase spectra of the sample and reference are individually computed. However, for the higher OD samples this procedure can cause errors in the lowest signal portions of the spectrum. For the OD 4 measurements, the phase spectra were computed using the OD 2 reference spectra. Drift in the phase can produce a false slope in the transmittance curves, which is folded into the repeatability estimates given below. We estimate the contributions of phase errors to the uncertainty in transmittance at 0.1 % for these measurements.

Table II lists the various type-B relative standard uncertainty component estimates, in percent of the measured value. They are added in quadrature to produce a standard uncertainty component due to type-B effects, σ_B . For the higher OD filters, the dominant source of uncertainty is the spatial non-uniformity of the metallic coatings.

UNCERTAINTY SOURCE	OD 1	OD 2	OD 3	OD 4
Type B				
Inter-reflections	0.20	0.30	0.30	0.30
Detector nonlinearity	0.10	0.10	0.05	0.05
Detector nonequivalence	0.20	0.20	0.10	0.10
Non-source emission	0.15	0.15	0.15	0.15
Beam nonuniformity	0.20	0.20	0.20	0.20
Beam displacement, deviation, focus shift	0.10	0.10	0.10	0.10
Beam geometry, polarization	0.20	0.20	0.20	0.20
Sample vignetting	0.03	0.03	0.03	0.03
Sample scattering	0.02	0.02	0.02	0.02
Phase errors	0.10	0.10	0.10	0.10
Sample nonuniformity	0.40	0.40	2.89	3.46
Sample temperature	0.20	0.20	0.20	0.20
Quadrature sum	0.65	0.68	2.93	3.50

Table II. Type-B relative standard uncertainty components for the four different sets of neutral density filters. Values are given in percent of measured transmittance.

Each filter was measured several times to reduce the effects of drift in the spectrometer. The measurements were evaluated for repeatability variance, σ_r^2 . A subset of filters from each set of 10 were measured again after a period of approximately 6 months, in order to test the reproducibility of the values. The number of measurements for each set of filters is listed in Table III.

SRM NUMBER	MEASUREMENT DAYS	FILTERS MEASURED	REPETITIONS PER DAY
2053	3	10 – day 1 10 – day 2 4 – day 3	6 – day 1 2 – day 2 2 – day 3
2054	2	10 – day 1 3 – day 2	6 – day 1 2 – day 2
2055	2	10 – day 1 10 – day 2	3 – day 1 2 – day 2
2056	2	10 – day 1 4 – day 2	3 – day 1 2 – day 2

Table III. Number of measurements for each filter set on different days, used to establish repeatability and reproducibility uncertainty components as described in the text.

A reproducibility variance, σ_R^2 , was assigned based on the variation in the mean value from one set of measurements to the next. A comparison of the two

variances was made for each set of filters to determine if the day-to-day variation in measurements was significant, according to the number of degrees of freedom in the data:

$$\sigma_R^2 = \frac{1}{3}\sigma_{days}^2 + \frac{7}{54}\sigma_r^2 \quad (26)$$

$$\sigma_R^2 = \frac{1}{2}\sigma_{days}^2 + \frac{1}{6}\sigma_r^2 \quad (27)$$

$$\sigma_R^2 = \frac{1}{2}\sigma_{days}^2 + \frac{5}{24}\sigma_r^2 \quad (28)$$

Eq. (26) applies to the 4 OD 1 filters measured on 3 separate days, Eq. (27) to the remaining OD 1 and OD 2 filters, and Eq. (28) to the OD 3 and OD 4 filters.

The filter in each set showing maximum daily variance, σ_{days}^2 , was used to estimate values for this variance component for each set of filters, which were averaged over several wavelength bands. Values of σ_{days} are shown in Table IV as percent of the average measured transmittance for each filter and wavelength band.

SRM NUMBER	2 μ m to 4 μ m	4 μ m to 12 μ m	12 μ m to 20 μ m	20 μ m to 25 μ m
2053	0.5	0.5	0.5	0.7
2054	0.5	0.3	0.4	0.8
2055	2.7	2.2	3.0	3.5
2056	2.0	4.0	5.0	---

Table IV. Relative uncertainty component σ_{days} averaged over four different wavelength bands for the four sets of filters, in units of percent of measured transmittance value. These were derived from the maximum variation in daily average observed for filters in a given set.

The repeatability variance, σ_r^2 , was found to be quite similar for each filter in a given set, and the average of these variances was used for each filter in the set. The final type-A variance components, σ_A^2 , for each filter's average transmittance values were computed for each wavelength position in the spectrum according to the following formulas:

$$\sigma_A^2 = \frac{1}{2}\sigma_{days}^2 + \frac{1}{6}\sigma_r^2 \quad (29)$$

$$\sigma_A^2 = \sigma_{days}^2 + \frac{1}{6}\sigma_r^2 \quad (30)$$

$$\sigma_A^2 = \frac{1}{2}\sigma_{days}^2 + \frac{5}{24}\sigma_r^2 \quad (31)$$

$$\sigma_A^2 = \sigma_{days}^2 + \frac{1}{3}\sigma_r^2 \quad (32)$$

where Eqs. (29), (30), (31), and (32) are used for the OD 1, OD 2, OD 3, and OD 4 filters, respectively. Then the type-B uncertainty component for each set of filters was added in quadrature to the type-A component from the above equations,

$$\sigma_{meas}^2 = \sigma_A^2 + \sigma_B^2 \quad (33)$$

For the OD 2 and OD 3 filters, which were measured relative to an OD 1 reference, and the OD 4 filters, which were measured relative to an OD 2 reference, the uncertainty of the reference transmittances were added in quadrature as well:

$$\sigma_{filter}^2 = \left(\frac{\sigma_{meas}^2}{T_{filter}^2} + \frac{\sigma_{reference}^2}{T_{reference}^2} \right) * T_{filter}^2 \quad (34)$$

The final expanded uncertainties were calculated with a coverage factor of 2, $\sigma_{final} = 2\sigma_{filter}$. Thus one set of expanded uncertainty values was generated for each set of filters of similar OD level. The average transmittance value of each individual filter over the different measurement days was used as the calibrated transmittance value for each filter. Table V shows relative expanded uncertainties at four different wavelengths for the four SRM filter types. Figure 7 shows the transmittance and associated expanded uncertainties for a representative filter from each OD level.

SRM NUMBER	2 μm	4 μm	12 μm	20 μm
2053	1.5	1.5	1.5	1.7
2054	2.3	2.1	2.2	2.7
2055	7.2	6.8	7.5	7.9
2056	10	11	14	27

Table V. Relative expanded uncertainties at four different wavelengths for the four sets of filters, in units of percent of measured transmittance value.

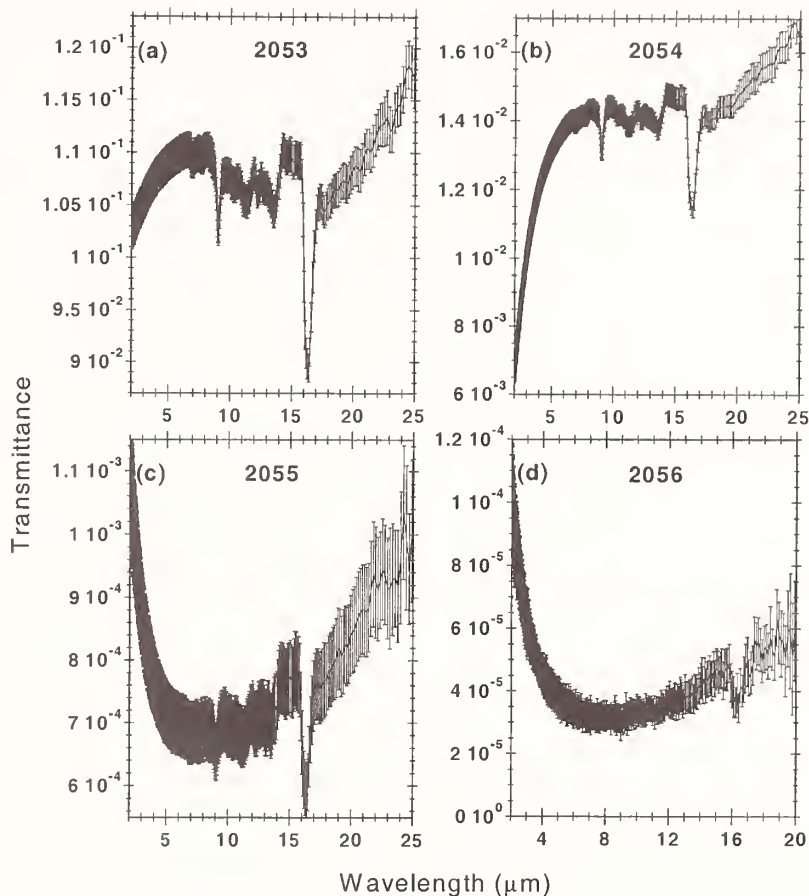

Figure 7. Transmittance versus wavelength for representative filters from each SRM set, showing expanded uncertainties in transmittance. The filters are individually calibrated, but the uncertainties in transmittance apply to every filter in a given set.

7. Summary

We have produced four sets of neutral-density transmitting infrared filters designed to be used over the 2 μm to 25 μm wavelength region for evaluating the accuracy of infrared spectrophotometers. The transmittances have been measured with relative expanded ($k=2$) uncertainties ranging from 1.5 % for the OD 1 filters (SRM 2053) to 12 % for the OD 4 filters (SRM 2056). The dominant source of uncertainty in transmittance for the OD 3 and OD 4 filters is the spatial non-uniformity of the metallic coatings. The near-ambient temperature dependence of the filter transmittances has been investigated and found to be negligible. In addition, the transmittances have been measured over a period of more than 1 year and found to be stable in time.

8. Acknowledgements

The authors gratefully acknowledge the contributions of M. Carroll Croarkin for consultation in the statistical analysis, and Joylene Thomas for support and coordination leading to the certification of SRMs 2053 through 2056.

9. References

- [1] R. Mavrodineanu and J. R. Baldwin, *Glass Filters as a SRM for Spectrophotometry – Selection, Preparation, Certification, and Use – SRM 930*, NBS Special Publication 260-51, U. S. Government Printing Office, Washington, D. C. (1975).
- [2] K. L. Eckerle, J. J. Hsia, K. D. Mielenz, and V. R. Weidner, *Regular Spectral Transmittance*, NBS Special Publication 250-6, U. S. Government Printing Office, Washington, D. C. (1975).
- [3] K. D. Mielenz and K. L. Eckerle, *Design, Construction, and Testing of a New High Accuracy Spectrophotometer*, NBS Technical Note 729, U. S. Government Printing Office, Washington, D. C. (1972).
- [4] K. L. Eckerle, V. R. Weidner, J. J. Hsia, and Z. W. Chao, *Extension of a Reference Spectrophotometer into the Near Infrared*, NBS Technical Note 1175, U. S. Government Printing Office, Washington, D. C. (1983).
- [5] P. Y. Barnes, E. A. Early, and A. C. Parr, *Spectral Reflectance*, NIST Special Publication 250-48, U. S. Government Printing Office, Washington, D. C. (1998).
- [6] D. Gupta, L. Wang, L. M. Hanssen, J. J. Hsia, and R. U. Datla, *Standard Reference Materials: Polystyrene Films for Calibrating the Wavelength Scale of Infrared Spectrophotometers – SRM 1921*, NIST Special Publication 260-122, U. S. Government Printing Office, Washington, D. C. (1995).
- [7] J. R. Birch and F. J. J. Clarke, "Fifty Categories of Ordinate Error in Fourier Transform Spectroscopy," *Spectros. Europe* **7**, 16-22 (1995).
- [8] A. Frenkel and Z. M. Zhang, "Broadband High Optical Density Filters in the Infrared," *Opt. Lett.* **19**, 1495-1497 (1994).
- [9] G. Lefever-Button, J. F. Lindblom, and F. R. Powell, "An Ultrathin Neutral Density Filter Set for the Infrared," *Proc. of SPIE* **3425**, 64-72 (1998).
- [10] O. S. Heavens, *Optical Properties of Thin Solid Films*, Dover, New York (1965).
- [11] C. J. Gabriel and A. Nedoluha, *Optica Acta* **18**, 415 (1971).
- [12] Z. M. Zhang, R. U. Datla, and L. M. Hanssen, "Development of Neutral-Density Infrared Filters Using Metallic Thin Films," *Proc. of MRS* (1994).
- [13] S. G. Kaplan, L. M. Hanssen, and R. U. Datla, "Testing the Radiometric Accuracy of Fourier Transform Infrared Transmittance Measurements," *Appl. Opt.* **36**, 8896 (1997).
- [14] B. N. Taylor and C. E. Kuyatt, *Guidelines for Evaluating and Expressing the Uncertainty of NIST Measurement Results*, NIST Technical Note 1297, U. S. Government Printing Office, Washington, D. C. (1994).



National Institute of Standards & Technology

Certificate

Standard Reference Material[®] 2053

Infrared Transmittance Standard

Serial No.: 1-1

This Standard Reference Material (SRM) is intended for use in checking the accuracy of the transmittance (ordinate) scale of spectrophotometers in the infrared (IR) spectral region from $2\mu\text{m}$ to $25\mu\text{m}$ (400cm^{-1} to 5000cm^{-1}). SRM 2053 is a neutral-density transmitting filter with an optical density near 1.0 ($\text{OD} = -\log_{10}(T)$, where T is the spectral transmittance). It consists of an approximately 20 nm thick nickel-chromium film on a 250 μm thick, 25 mm diameter, high-resistivity, single-crystal $\langle 100 \rangle$ silicon substrate. The metal film is overcoated with a thin (30 nm) layer of silicon oxide to protect it against oxidation from the atmosphere. SRM 2053 also includes a floppy disk that contains the certified transmittance values and associated expanded uncertainties.

Certified Transmittance Values: The transmittance of this filter was measured at equally spaced wavenumber values from 400cm^{-1} to 5000cm^{-1} ($2\mu\text{m}$ to $25\mu\text{m}$) with an apodized resolution of 8cm^{-1} and a data spacing interval of approximately 4cm^{-1} . The transmittance was measured at the center of the filter using a 6 mm diameter spot size with the filter at the focus of an $f/3$ optical beam in the spectrophotometer. The certified transmittance values and associated expanded uncertainties at each wavelength are listed in a text file on the accompanying floppy disk and plotted in Figure 1. These values and their associated uncertainties are valid for normal incidence transmittance within a 5 mm radius of the center of the filter and at temperatures from 20°C to 30°C .

Expiration of Certification: The certification of this SRM is deemed to be valid until **31 December 2001**, provided the SRM is stored and handled in accordance with the Storage and Handling section of this certificate. Certification will be nullified if the SRM is damaged, contaminated, or exposed to excessive temperatures or humidity.

Maintenance of SRM Certification: The neutral-density filter has been measured over a period of approximately one year, and no significant change in transmittance has been noted. A reference filter is kept at NIST and will be monitored over time. Users will be notified if a significant change occurs before the stated expiration date.

The technical measurements leading to certification were performed by S.G. Kaplan and L.M. Hanssen of the NIST Optical Technology Division. The overall direction and coordination of the technical measurements were performed by R.U. Datla of the NIST Optical Technology Division.

Statistical consultation was provided by M.C. Croarkin of the NIST Statistical Engineering Division.

The support aspects involved in the preparation, certification, and issuance of this SRM were coordinated through the NIST Standard Reference Materials Program by J.W.L. Thomas.

Albert C. Parr, Chief
Optical Technology Division

Gaithersburg, MD 20899
Certificate Issue Date: 09 August 2000

Nancy M. Trahey, Chief
Standard Reference Materials Program

Source of Material: The silicon substrates used in making the filters were obtained from Virginia Semiconductor Corporation¹ of Fredericksburg, VA. The metal films were deposited on the substrates by Luxel Corporation¹ of Friday Harbor, WA.

CERTIFICATION ANALYSIS

Measurement Conditions: The certified transmittance values were measured using a Bio-Rad FTS-60A¹ Fourier transform infrared (FT-IR) spectrophotometer. The temperature in the filter compartment of the instrument was approximately 29°C, and the spectrophotometer was purged with dry, carbon dioxide free air. Details of the measurements and analysis can be found in Reference [1].

Determination of Uncertainty in Transmittance: The combined uncertainty includes “Type A” uncertainties, which are evaluated by statistical methods, and “Type B” uncertainties, which are determined by other means. Type A uncertainties include the reproducibility, listed in Table 1, and the repeatability, listed on the accompanying floppy disk. Each filter was measured six times in one day, then removed from the spectrophotometer and measured twice, approximately six weeks later. A subset of the 10 nominally identical filters in this batch were again measured twice, approximately six months after the first set of measurements. Each set of measurements was evaluated for repeatability variance, s_r^2 . The day-to-day variance was also computed for each filter and no evidence of long-term drift in the measurements was found. The maximum daily variance of all the filter measurements was used as the value of reproducibility variance, s_{days}^2 , which was averaged over several different wavelength bands. Values for a number of systematic (Type B) sources of uncertainty were also estimated (Table 1) and added in quadrature to produce a variance component, s_B^2 . The combined uncertainty for the filter was calculated as

$$s_{\text{filter}}^2 = \frac{1}{6} s_r^2 + \frac{1}{2} s_{\text{days}}^2 + s_B^2 \quad (1)$$

The expanded uncertainty (coverage factor of 2) was calculated as $2s_{\text{filter}}$ [2]. Representative curves for the certified transmittance values and associated expanded uncertainties in transmittance are shown in Figures 1 (a) and (b). The certified values and uncertainties are listed in the data file on the accompanying floppy disk.

INSTRUCTIONS FOR USE

Storage and Handling: SRM 2053 is quite fragile and should be handled with care when mounting and dismounting it from the measurement apparatus. The filter may be handled by wearing clean plastic or thin rubber gloves and holding it gently by the edge. The surfaces should never be touched. Dust can be removed by gently blowing the surface with clean, dry air. When not in use, the SRM should always be kept in its accompanying protective box, which has the SRM serial number engraved on the bottom. It is recommended that the SRM be stored in a dessicator cabinet, if available.

Test Measurements: The spectrophotometer system should be set up under the following conditions. The spectral resolution should ideally be 8 cm^{-1} in order to match that used in the SRM calibration measurements. Lower (i.e., larger cm^{-1} value) resolution may be used and the certified values averaged to match the resolution of the measurement. At resolutions higher than 8 cm^{-1} , Fabry-Perot fringes will appear in the spectrum due to interference in the silicon substrate. In addition, the depth and width of the prominent silicon absorption features near $9\text{ }\mu\text{m}$ and $16\text{ }\mu\text{m}$ wavelengths, and weaker structures at intervening wavelengths, will be affected by choice of resolution. It is recommended that transmittance levels away from these features be used to compare the user’s data with the SRM calibration data if the user’s resolution is different from 8 cm^{-1} .

The IR beam parallelism may range from collimated up to $f/3$ focusing geometry. The beam should be centered on the filter with a spot size less than 10 mm in diameter. For most FT-IR spectrophotometers, a spot size in the 1 mm to 5 mm diameter range will be most convenient. The average angle of incidence at the filter surface should be less than 6° . The filter should be reproducibly moved in and out of the beam path and the spectra, with and without the

¹Certain commercial equipment, instruments, or materials are identified in this certificate in order to adequately specify the experimental procedure. Such identification does not imply recommendation or endorsement by the National Institute of Standards and Technology, nor does it imply that the materials or equipment identified are necessarily the best available for this purpose.

filter in place, ratioed to produce a transmittance spectrum. The measurements should be repeated several times in order to assess their reproducibility.

Steps should be taken to reduce the effects of detector nonlinearity, ambient thermal emission, and inter-reflections involving the filter, spectrophotometer, and detector. The magnitude of each of these effects will depend on the user's system and may be reduced by using additional filters and/or stops in the beam path, tilting the filter slightly or blocking half of the beam, and performing additional measurements to test for the effects of ambient thermal emission not coming from the source. A measurement should be made with the beam path at the filter position blocked with an opaque object in order to test for stray light or electronic offset which could produce a false transmittance signal. If a significant signal is found, it should be subtracted from both the filter and reference measurements before ratioing them to obtain the filter transmittance.

Comparison with Certified Values: The primary purpose of this SRM is to check the accuracy of the transmittance (ordinate) scale of the user's spectrophotometer system. In conjunction with SRMs 2054, 2055, and 2056, transmittance measurements of this filter can be used to assess the linearity of the instrument response scale. The user's transmittance spectrum should be compared with the certified values at the wavelength(s) of interest. If the user's values differ from the certified values by less than the quadrature sum of the certified expanded uncertainties and the expanded uncertainty of the mean of the user's values, then the user's values are accurate to this level and no correction should be attempted on the basis of comparison with this SRM.

If the user's measured values differ significantly from the certified values, then additional steps along the lines suggested in the previous section may be taken in order to attempt to improve the transmittance (ordinate) scale accuracy of the instrument. Because of the wide variety of possible spectrophotometer systems and the number and complexity of the various sources of error that may be present in different systems, it is not possible to give a general correction algorithm that will work for all systems. The user of FT-IR systems is referred to the literature on the accuracy of measurements with these instruments [3]. In particular, it should be noted that different types of filters will introduce very different sources of error into the measurements. This SRM is highly reflective and has a transmittance significantly less than 1, so it will tend to reveal errors due to detector nonlinearity and inter-reflections. However, it is optically quite thin and will not yield much difference in the beam geometry, with and without the filter in place, which can be a significant source of error for thicker filters.

REFERENCES

- [1] Kaplan, S.G. and Hanssen, L.M., "Standard Reference Materials: Infrared Transmittance Standards – SRMs 2053, 2054, 2055, and 2056," NIST Special Publication 260-123, In Preparation (2000).
- [2] *Guide to the Expression of Uncertainty in Measurement*, ISBN 92-67-10188-9, 1st Ed. ISO, Geneva, Switzerland, (1993); see also Taylor, B.N. and Kuyatt, C.E., "Guidelines for Evaluating and Expressing Uncertainty of NIST Measurement Results," NIST Technical Note 1297, U.S. Government Printing Office, Washington DC, (1994); available at <http://physics.nist.gov/Pubs/>.
- [3] Kaplan, S.G., Hanssen, L.M., and Datla, R.U., "Testing the radiometric accuracy of Fourier transform infrared transmittance measurements," *Appl. Opt.* **36**, 8896 (1997), and references therein.

Users of this SRM should ensure that the certificate in their possession is current. This can be accomplished by contacting the SRM Program at: telephone (301) 975-6776; fax (301) 926-4751; e-mail srminfo@nist.gov; or via the Internet <http://www.nist.gov/srm>.

Table 1. Standard uncertainty components, in percent of measured transmittance value, for systematic uncertainty sources as well as reproducibility in the measured values.

Uncertainty source	Value (%)
Type B	
Inter-reflections	0.20
Detector nonlinearity	0.10
Detector nonequivalence	0.20
Non-source emission	0.15
Beam nonuniformity	0.20
Beam displacement, deviation, focus shift	0.10
Beam geometry, polarization	0.20
Filter vignetting	0.03
Filter scattering	0.02
Phase errors	0.10
Filter nonuniformity	0.40
Filter temperature	0.20
Quadrature sum, s_B	0.65
Type A (Reproducibility, s_{days})	
Daily variation 2 μm to 4 μm	0.50
Daily variation 4 μm to 12 μm	0.50
Daily variation 12 μm to 20 μm	0.50
Daily variation 20 μm to 25 μm	0.70

SRM 2053
Serial No. 1-1

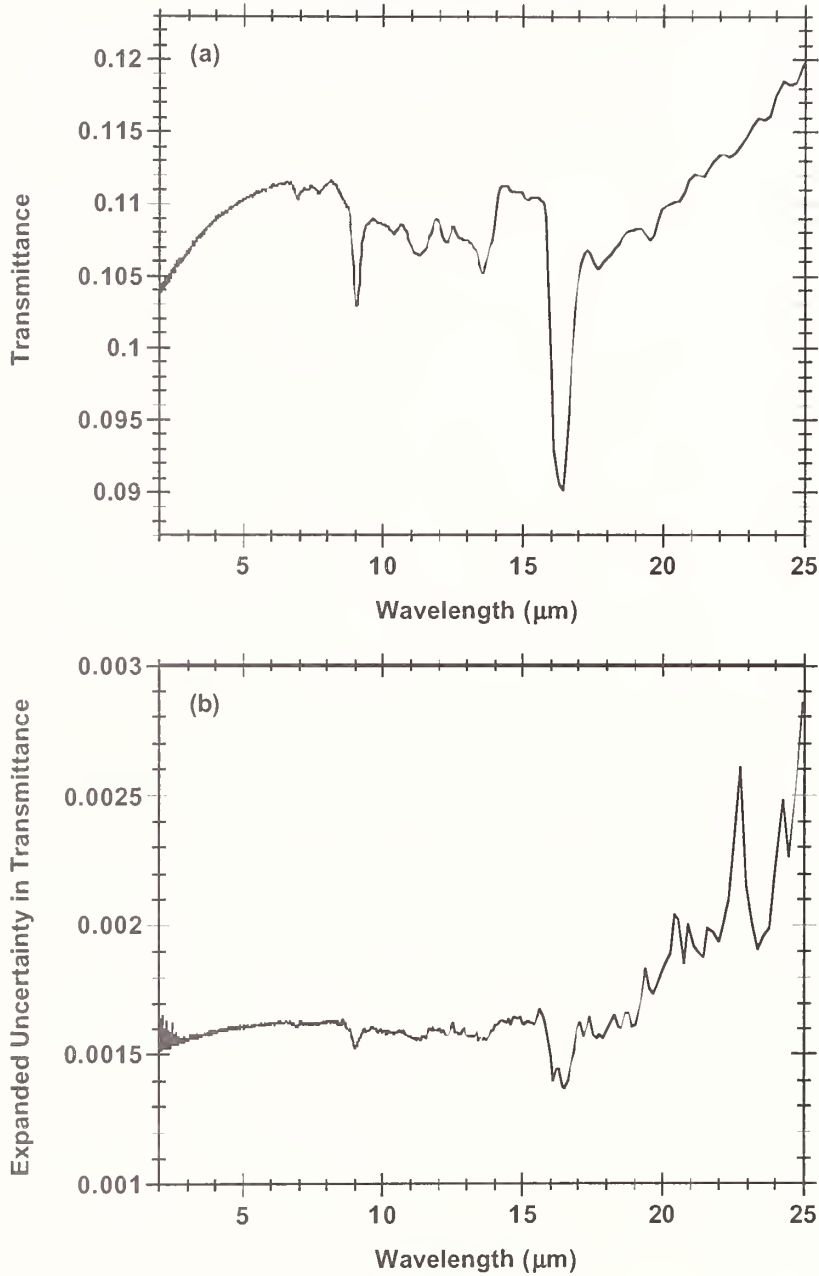

Figure 1. (a) Certified transmittance versus wavelength, and (b) expanded uncertainty in transmittance of the neutral-density filter. The graphs should not be scaled to produce data for the filter. Data should be taken from the file on the accompanying floppy disk.



National Institute of Standards & Technology

Certificate

Standard Reference Material[®] 2054

Infrared Transmittance Standard

Serial No.: 1-1

This Standard Reference Material (SRM) is intended for use in checking the accuracy of the transmittance (ordinate) scale of spectrophotometers in the infrared (IR) spectral region from $2\mu\text{m}$ to $25\mu\text{m}$ (400cm^{-1} to 5000cm^{-1}). SRM 2054 is a neutral-density transmitting filter with an optical density near 2.0 ($\text{OD} = -\log_{10}(T)$, where T is the spectral transmittance). It consists of an approximately 90 nm thick nickel-chromium film on a $250\mu\text{m}$ thick, 25 mm diameter, high-resistivity, single-crystal $\langle 100 \rangle$ silicon substrate. The metal film is overcoated with a thin (30 nm) layer of silicon oxide to protect it against oxidation from the atmosphere. SRM 2054 also includes a floppy disk that contains the certified transmittance values and associated expanded uncertainties.

Certified Transmittance Values: The transmittance of this filter was measured at equally spaced wavenumber values from 400cm^{-1} to 5000cm^{-1} ($2\mu\text{m}$ to $25\mu\text{m}$) with an apodized resolution of 8cm^{-1} and a data spacing interval of approximately 4cm^{-1} . The transmittance was measured at the center of the filter using a 6 mm diameter spot size with the filter at the focus of an $f/3$ optical beam in the spectrophotometer. The certified transmittance values and associated expanded uncertainties at each wavelength are listed in a text file on the accompanying floppy disk and plotted in Figure 1. These values and their associated uncertainties are valid for normal incidence transmittance within a 5 mm radius of the center of the filter and at temperatures from 20°C to 30°C .

Expiration of Certification: The certification of this SRM is deemed to be valid until **31 December 2001**, provided the SRM is stored and handled in accordance with the Storage and Handling section of this certificate. Certification will be nullified if the SRM is damaged, contaminated, or exposed to excessive temperatures or humidity.

Maintenance of SRM Certification: The neutral-density filter has been measured over a period of approximately one year, and no significant change in transmittance has been noted. A reference filter is kept at NIST and will be monitored over time. Users will be notified if a significant change occurs before the stated expiration date.

The technical measurements leading to certification were performed by S.G. Kaplan and L.M. Hanssen of the NIST Optical Technology Division. The overall direction and coordination of the technical measurements were performed by R.U. Datla of the NIST Optical Technology Division.

Statistical consultation was provided by M.C. Croarkin of the NIST Statistical Engineering Division.

The support aspects involved in the preparation, certification, and issuance of this SRM were coordinated through the NIST Standard Reference Materials Program by J.W.L. Thomas.

Albert C. Parr, Chief
Optical Technology Division

Gaithersburg, MD 20899
Certificate Issue Date: 09 August 2000

Nancy M. Trahey, Chief
Standard Reference Materials Program

Source of Material: The silicon substrates used in making the filters were obtained from Virginia Semiconductor Corporation¹ of Fredericksburg, VA. The metal films were deposited on the substrates by Luxel Corporation¹ of Friday Harbor, WA.

CERTIFICATION ANALYSIS

Measurement Conditions: The calibration measurements were made using a Bio-Rad FTS-60A¹ Fourier transform infrared (FT-IR) spectrophotometer. The temperature in the filter compartment of the instrument was approximately 29 °C, and the spectrophotometer was purged with dry, carbon dioxide free air. A neutral-density filter with optical density near 1 (SRM 2053) was used as the reference in measuring the transmittance of this SRM. The transmittance of the filter under test was calculated from

$$T_{\text{filter}} = T_{\text{relative}} \times T_{\text{reference}} \quad (1)$$

Details of the measurement and analysis can be found in Reference [1].

Determination of Uncertainty in Transmittance: The combined uncertainty includes “Type A” uncertainties, which are evaluated by statistical methods, and “Type B” uncertainties, which are determined by other means. Type A uncertainties include the reproducibility, listed in Table 1, and the repeatability, listed on the accompanying floppy disk. Each filter was measured six times in one day, then removed from the spectrophotometer. A subset of the 10 nominally identical filters in this batch were again measured twice approximately six months after the first set of measurements. Each set of measurements was evaluated for repeatability variance, s_r^2 . The day-to-day variance was also computed for each filter, and no evidence of long-term drift in the measurements was found. The maximum daily variance of all the filter measurements was used as the value of reproducibility variance, s_{days}^2 , which was averaged over several different wavelength bands. Values for a number of systematic (Type B) sources of uncertainty were also estimated (Table 1) and added in quadrature to produce a variance component s_B^2 . The variance in transmittance of the OD 1 reference is $s_{\text{reference}}^2$. The combined uncertainty for the filter was calculated from

$$s_{\text{meas}}^2 = \frac{1}{3}s_r^2 + s_{\text{days}}^2 + s_B^2$$

$$s_{\text{filter}}^2 = \left(\frac{s_{\text{meas}}^2}{T_{\text{filter}}^2} + \frac{s_{\text{reference}}^2}{T_{\text{reference}}^2} \right) \times T_{\text{filter}}^2 \quad (2)$$

The expanded uncertainty (coverage factor of 2) is $2s_{\text{filter}}$. Representative curves for the certified transmittance values and associated expanded uncertainties in transmittance are shown in Figures 1 (a) and (b). The certified values and uncertainties are listed in the data file on the accompanying floppy disk.

INSTRUCTIONS FOR USE

Storage and Handling: The SRM is quite fragile and should be handled with care when mounting and dismounting it from the measurement apparatus. The filter may be handled by wearing clean plastic or thin rubber gloves and holding it gently by the edge. The surfaces should never be touched. Dust can be removed by gently blowing the surface with clean, dry air. When not in use, SRM 2054 should always be kept in its accompanying protective box, which has the SRM serial number engraved on the bottom. It is recommended that the SRM be stored in a dessicator cabinet, if available.

Test Measurements: The spectrophotometer system should be set up under the following conditions. The spectral resolution should ideally be 8 cm^{-1} in order to match that used in the SRM calibration measurements. Lower (i.e., larger cm^{-1} value) resolution may be used and the certified values averaged to match the resolution of the measurement. At resolutions higher than 8 cm^{-1} , Fabry-Perot fringes will appear in the spectrum due to interference in the silicon substrate. In addition, the depth and width of the prominent silicon absorption features near $9\text{ }\mu\text{m}$ and

¹ Certain commercial equipment, instruments, or materials are identified in this certificate in order to adequately specify the experimental procedure. Such identification does not imply recommendation or endorsement by the National Institute of Standards and Technology, nor does it imply that the materials or equipment identified are necessarily the best available for this purpose.

16 μm wavelengths, and weaker structures at intervening wavelengths, will be affected by choice of resolution. It is recommended that transmittance levels away from these features be used to compare the user's data with the SRM calibration data if the user's resolution is different from 8 cm^{-1} .

The IR beam parallelism may range from collimated up to $f/3$ focusing geometry. The beam should be centered on the filter with a spot size less than 10 mm in diameter. For most FTIR spectrophotometers, a spot size in the 1 mm to 5 mm diameter range will be most convenient. The average angle of incidence at the filter surface should be less than 6° . The filter should be reproducibly moved in and out of the beam path and the spectra, with and without the filter in place, ratioed to produce a transmittance spectrum. The measurements should be repeated several times in order to assess their reproducibility.

Steps should be taken to reduce the effects of detector nonlinearity, ambient thermal emission, and inter-reflections involving the filter, spectrophotometer, and detector. The magnitude of each of these effects will depend on the user's system and may be reduced by using additional filters and/or stops in the beam path, tilting the filter slightly or blocking half of the beam, and performing additional measurements to test for the effects of ambient thermal emission not coming from the source. A measurement should be made with the beam path at the filter position blocked with an opaque object in order to test for stray light or electronic offset which could produce a false transmittance signal. If a significant signal is found, it should be subtracted from both the filter and reference measurements before ratioing them to obtain the filter transmittance.

Comparison with Certified Values: The primary purpose of this SRM is to check the accuracy of the transmittance (ordinate) scale of the user's spectrophotometer system. In conjunction with SRMs 2053, 2055, and 2056, transmittance measurements of this filter can be used to assess the linearity of the instrument response scale. The user's transmittance spectrum should be compared with the certified values at the wavelength(s) of interest. If the user's values differ from the certified values by less than the quadrature sum of the certified expanded uncertainties and the expanded uncertainty of the mean of the user's values, then the user's values are accurate to this level and no correction should be attempted on the basis of comparison with this SRM.

If the user's measured values differ significantly from the certified values, then additional steps along the lines suggested in the previous section may be taken in order to attempt to improve the transmittance (ordinate) scale accuracy of the instrument. Because of the wide variety of possible spectrophotometer systems and the number and complexity of the various sources of error that may be present in different systems, it is not possible to give a general correction algorithm that will work for all systems. The user of FT-IR systems is referred to the literature on the accuracy of measurements with these instruments [3]. In particular, it should be noted that different types of filters will introduce very different sources of error into the measurements. This SRM is highly reflective and has a transmittance significantly less than 1, so it will tend to reveal errors due to detector nonlinearity and inter-reflections. However, it is optically quite thin and will not yield much difference in the beam geometry, with and without the filter in place, which can be a significant source of error for thicker filters.

REFERENCES

- [1] Kaplan, S.G. and Hanssen, L.M., "Standard Reference Materials: Infrared Transmittance Standards – SRMs 2053, 2054, 2055, and 2056," NIST Special Publication 260-123, In Preparation (2000).
- [2] *Guide to the Expression of Uncertainty in Measurement*, ISBN 92-67-10188-9. 1st Ed. ISO, Geneva, Switzerland, (1993); see also Taylor, B.N. and Kuyatt, C.E., "Guidelines for Evaluating and Expressing Uncertainty of NIST Measurement Results," NIST Technical Note 1297, U.S. Government Printing Office, Washington DC, (1994); available at <http://physics.nist.gov/Pubs/>.
- [3] Kaplan, S.G., Hanssen, L.M., and Datla, R.U., "Testing the radiometric accuracy of Fourier transform infrared transmittance measurements," *Appl. Opt.* **36**, 8896 (1997), and references therein.

Users of this SRM should ensure that the certificate in their possession is current. This can be accomplished by contacting the SRM Program at: telephone (301) 975-6776; fax (301) 926-4751; e-mail srminfo@nist.gov; or via the Internet <http://www.nist.gov/srm>.

Table 1. Standard uncertainty components, in percent of measured transmittance value, for systematic uncertainty sources as well as reproducibility in the measured values.

Uncertainty source	Value (%)
Type B	
Inter-reflections	0.30
Detector nonlinearity	0.10
Detector nonequivalence	0.20
Non-source emission	0.15
Beam nonuniformity	0.20
Beam displacement, deviation, focus shift	0.10
Beam geometry, polarization	0.20
Filter vignetting	0.03
Filter scattering	0.02
Phase errors	0.10
Filter nonuniformity	0.40
Filter temperature	0.20
Quadrature sum, s_B	0.68
Type A (Reproducibility, s_{days})	
Daily variation 2 μm to 4 μm	0.50
Daily variation 4 μm to 12 μm	0.30
Daily variation 12 μm to 20 μm	0.40
Daily variation 20 μm to 25 μm	0.80

SRM 2054
Serial No. 1-1

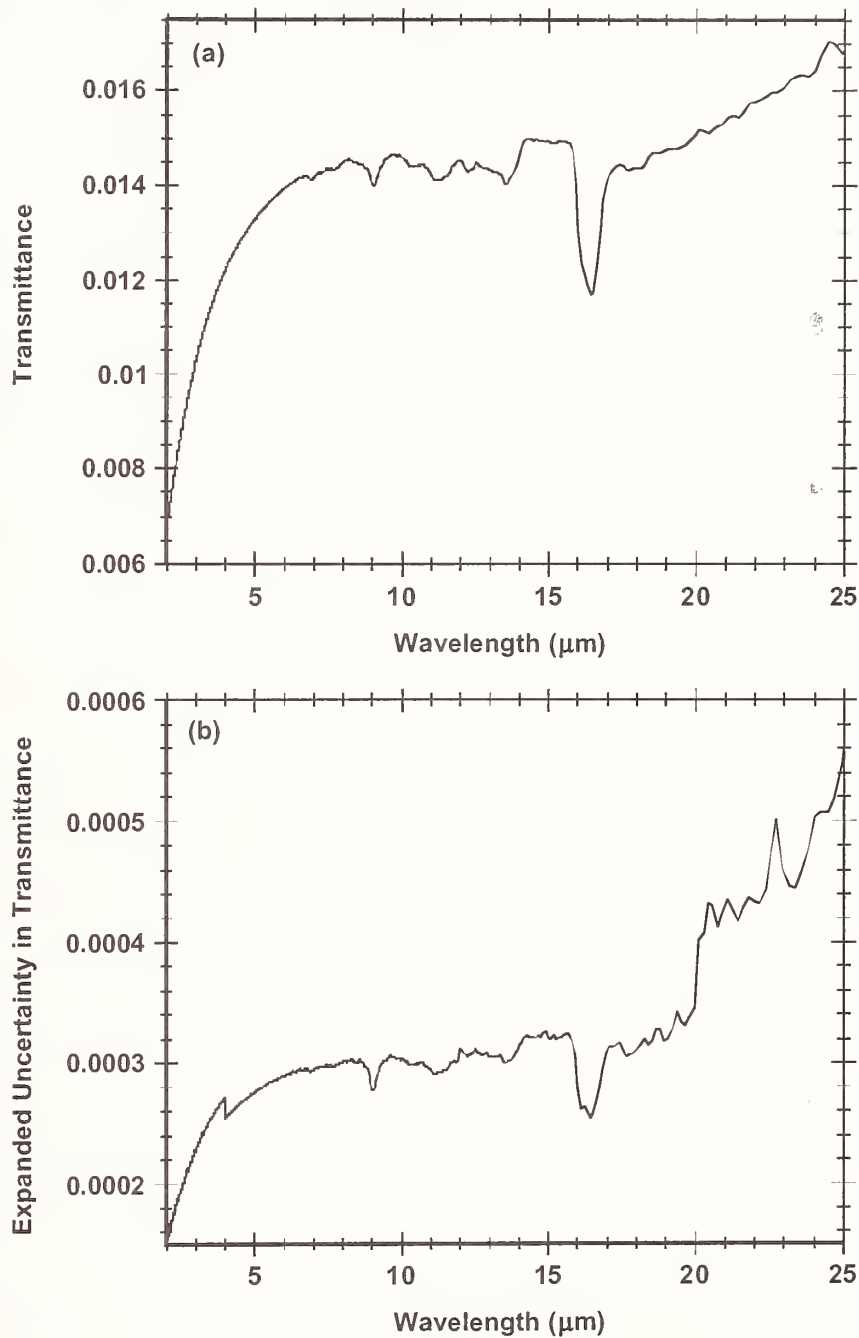

Figure 1. (a) Certified transmittance versus wavelength, and (b) expanded uncertainty in transmittance of the neutral-density filter. The graphs should not be scaled to produce data for the filter. Data should be taken from the file on the accompanying floppy disk.



National Institute of Standards & Technology

Certificate

Standard Reference Material[®] 2055

Infrared Transmittance Standard

Serial No.: 1-1

This Standard Reference Material (SRM) is intended for use in checking the accuracy of the transmittance (ordinate) scale of spectrophotometers in the infrared (IR) spectral region from $2\mu\text{m}$ to $25\mu\text{m}$ (400 cm^{-1} to 5000 cm^{-1}). SRM 2055 is a neutral-density transmitting filter with an optical density near 3.0 ($\text{OD} = -\log_{10}(T)$, where T is the spectral transmittance). It consists of an approximately 77 nm thick copper-nickel film on a $250\mu\text{m}$ thick, 25 mm diameter, high-resistivity, single-crystal $\langle 100 \rangle$ silicon substrate. The metal film is overcoated with a thin (30 nm) layer of silicon oxide to protect it against oxidation from the atmosphere. SRM 2055 also includes a floppy disk that contains the certified transmittance values and associated expanded uncertainties.

Certified Transmittance Values: The transmittance of this filter was measured at equally spaced wavenumber values from 400 cm^{-1} to 5000 cm^{-1} ($2\mu\text{m}$ to $25\mu\text{m}$) with an apodized resolution of 8 cm^{-1} and a data spacing interval of approximately 4 cm^{-1} . The transmittance was measured at the center of the filter using a 6 mm diameter spot size with the filter at the focus of an $f/3$ optical beam in the spectrophotometer. The certified transmittance values and associated expanded uncertainties at each wavelength are listed in a text file on the accompanying floppy disk and plotted in Figure 1. These values and their associated uncertainties are valid for normal incidence transmittance within a 5 mm radius of the center of the filter and at temperatures from $20\text{ }^\circ\text{C}$ to $30\text{ }^\circ\text{C}$.

Expiration of Certification: The certification of this SRM is deemed to be valid until **31 December 2001**, provided the SRM is stored and handled in accordance with the Storage and Handling section of this certificate. Certification will be nullified if the SRM is damaged, contaminated, or exposed to excessive temperatures or humidity.

Maintenance of SRM Certification: The neutral-density filter has been measured over a period of approximately one year, and no significant change in transmittance has been noted. A reference filter is kept at NIST and will be monitored over time. Users will be notified if a significant change occurs before the stated expiration date.

The technical measurements leading to certification were performed by S.G. Kaplan and L.M. Hanssen of the NIST Optical Technology Division. The overall direction and coordination of the technical measurements were performed by R.U. Datla of the NIST Optical Technology Division.

Statistical consultation was provided by M.C. Croarkin of the NIST Statistical Engineering Division.

The support aspects involved in the preparation, certification, and issuance of this SRM were coordinated through the NIST Standard Reference Materials Program by J.W.L. Thomas.

Albert C. Parr, Chief
Optical Technology Division

Nancy M. Trahey, Chief
Standard Reference Materials Program

Gaithersburg, MD 20899
Certificate Issue Date: 09 August 2000

Source of Material: The silicon substrates used in making the filters were obtained from Virginia Semiconductor Corporation¹ of Fredericksburg, VA. The metal films were deposited on the substrates by Luxel Corporation¹ of Friday Harbor, WA.

CERTIFICATION ANALYSIS

Measurement Conditions: The calibration measurements were made using a Bio-Rad FTS-60A¹ Fourier transform infrared (FT-IR) spectrophotometer. The temperature in the filter compartment of the instrument was approximately 29 °C, and the spectrophotometer was purged with dry, carbon dioxide free air. A neutral-density filter with optical density near 1 (SRM 2053) was used as the reference in measuring the transmittance of this SRM. The transmittance of the filter under test was calculated from

$$T_{\text{filter}} = T_{\text{relative}} \times T_{\text{reference}} \quad (1)$$

Details of the measurement and analysis can be found in Reference [1].

Determination of Uncertainty in Transmittance: The combined uncertainty includes “Type A” uncertainties, which are evaluated by statistical methods, and “Type B” uncertainties, which are determined by other means. Type A uncertainties include the reproducibility, listed in Table 1, and the repeatability, listed on the accompanying floppy disk. Each filter was measured three times in one day, then removed from the spectrophotometer. Each of the 10 nominally identical filters in this batch was again measured twice approximately six months after the first set of measurements. Each set of measurements was evaluated for repeatability variance, s_r^2 . The day-to-day variance was also computed for each filter, and no evidence of long-term drift in the measurements was found. The maximum daily variance of all the filter measurements was used as the value of reproducibility variance, s_{days}^2 , which was averaged over several different wavelength bands. Values for a number of systematic (Type B) sources of uncertainty were also estimated (Table 1) and added in quadrature to produce a variance component s_B^2 . The variance in transmittance of the OD 1 reference is $s_{\text{reference}}^2$. The combined uncertainty for the filter was calculated from

$$s_{\text{meas}}^2 = \frac{1}{3} s_r^2 + s_{\text{days}}^2 + s_B^2 \quad (2)$$

$$s_{\text{filter}}^2 = \left(\frac{s_{\text{meas}}^2}{T_{\text{filter}}^2} + \frac{s_{\text{reference}}^2}{T_{\text{reference}}^2} \right) \times T_{\text{filter}}^2$$

The expanded uncertainty (coverage factor of 2) is $2s_{\text{filter}}$. Representative curves for the certified transmittance values and associated expanded uncertainties in transmittance are shown in Figures 1 (a) and (b). The certified values and uncertainties are listed in the data file on the accompanying floppy disk.

INSTRUCTIONS FOR USE

Storage and Handling: The SRM is quite fragile and should be handled with care when mounting and dismounting it from the measurement apparatus. The filter may be handled by wearing clean plastic or thin rubber gloves and holding it gently by the edge. The surfaces should never be touched. Dust can be removed by gently blowing the surface with clean, dry air. When not in use, SRM 2055 should always be kept in its accompanying protective box, which has the SRM serial number engraved on the bottom. It is recommended that the SRM be stored in a desiccator cabinet, if available.

Test Measurements: The spectrophotometer system should be set up under the following conditions. The spectral resolution should ideally be 8cm^{-1} in order to match that used in the SRM calibration measurements. Lower (i.e., larger cm^{-1} value) resolution may be used and the certified values averaged to match the resolution of the

¹ Certain commercial equipment, instruments, or materials are identified in this certificate in order to adequately specify the experimental procedure. Such identification does not imply recommendation or endorsement by the National Institute of Standards and Technology, nor does it imply that the materials or equipment identified are necessarily the best available for this purpose.

measurement. At resolutions higher than 8 cm^{-1} , Fabry-Perot fringes will appear in the spectrum due to interference in the silicon substrate. In addition, the depth and width of the prominent silicon absorption features near $9\text{ }\mu\text{m}$ and $16\text{ }\mu\text{m}$ wavelengths, and weaker structures at intervening wavelengths, will be affected by choice of resolution. It is recommended that transmittance levels away from these features be used to compare the user's data with the SRM calibration data if the user's resolution is different from 8 cm^{-1} .

The IR beam parallelism may range from collimated up to $f/3$ focusing geometry. The beam should be centered on the filter with a spot size less than 10 mm in diameter. For most FT-IR spectrophotometers, a spot size in the 1 mm to 5 mm diameter range will be most convenient. The average angle of incidence at the filter surface should be less than 6° . The filter should be reproducibly moved in and out of the beam path and the spectra, with and without the filter in place, ratioed to produce a transmittance spectrum. The measurements should be repeated several times in order to assess their reproducibility.

Steps should be taken to reduce the effects of detector nonlinearity, ambient thermal emission, and inter-reflections involving the filter, spectrophotometer, and detector. The magnitude of each of these effects will depend on the user's system and may be reduced by using additional filters and/or stops in the beam path, tilting the filter slightly or blocking half of the beam, and performing additional measurements to test for the effects of ambient thermal emission not coming from the source. A measurement should be made with the beam path at the filter position blocked with an opaque object in order to test for stray light or electronic offset which could produce a false transmittance signal. If a significant signal is found, it should be subtracted from both the filter and reference measurements before ratioing them to obtain the filter transmittance.

Comparison with Certified Values: The primary purpose of this SRM is to check the accuracy of the transmittance (ordinate) scale of the user's spectrophotometer system. In conjunction with SRMs 2053, 2054, and 2056, transmittance measurements of this filter can be used to assess the linearity of the instrument response scale. The user's transmittance spectrum should be compared with the certified values at the wavelength(s) of interest. If the user's values differ from the certified values by less than the quadrature sum of the certified expanded uncertainties and the expanded uncertainty of the mean of the user's values, then the user's values are accurate to this level and no correction should be attempted on the basis of comparison with this SRM.

If the user's measured values differ significantly from the certified values, then additional steps along the lines suggested in the previous section may be taken in order to attempt to improve the transmittance (ordinate) scale accuracy of the instrument. Because of the wide variety of possible spectrophotometer systems and the number and complexity of the various sources of error that may be present in different systems, it is not possible to give a general correction algorithm that will work for all systems. The user of FT-IR systems is referred to the literature on the accuracy of measurements with these instruments [3]. In particular, it should be noted that different types of filters will introduce very different sources of error into the measurements. This SRM is highly reflective and has a transmittance significantly less than 1, so it will tend to reveal errors due to detector nonlinearity and inter-reflections. However, it is optically quite thin and will not yield much difference in the beam geometry, with and without the filter in place, which can be a significant source of error for thicker filters.

REFERENCES

- [1] Kaplan, S.G. and Hanssen, L.M., "Standard Reference Materials: Infrared Transmittance Standards – SRMs 2053, 2054, 2055, and 2056," NIST Special Publication 260-123, In Preparation (2000).
- [2] *Guide to the Expression of Uncertainty in Measurement*, ISBN 92-67-10188-9, 1st Ed. ISO, Geneva, Switzerland, (1993); see also Taylor, B.N. and Kuyatt, C.E., "Guidelines for Evaluating and Expressing Uncertainty of NIST Measurement Results," NIST Technical Note 1297, U.S. Government Printing Office, Washington DC, (1994); available at <http://physics.nist.gov/Pubs/>.
- [3] Kaplan, S.G., Hanssen, L.M., and Datla, R.U., "Testing the radiometric accuracy of Fourier transform infrared transmittance measurements," *Appl. Opt.* **36**, 8896 (1997), and references therein.

Users of this SRM should ensure that the certificate in their possession is current. This can be accomplished by contacting the SRM Program at: telephone (301) 975-6776; fax (301) 926-4751; e-mail srminfo@nist.gov; or via the Internet <http://www.nist.gov/srm>.

Table 1. Standard uncertainty components, in percent of measured transmittance value, for systematic uncertainty sources as well as reproducibility in the measured values.

Uncertainty source	Value (%)
Type B	
Inter-reflections	0.30
Detector nonlinearity	0.05
Detector nonequivalence	0.10
Non-source emission	0.15
Beam nonuniformity	0.20
Beam displacement, deviation, focus shift	0.10
Beam geometry, polarization	0.20
Filter vignetting	0.03
Filter scattering	0.02
Phase errors	0.10
Filter nonuniformity	2.89
Filter temperature	0.20
Quadrature sum, s_B	2.93
Type A (Reproducibility, s_{days})	
Daily variation 2 μm to 4 μm	2.70
Daily variation 4 μm to 12 μm	2.20
Daily variation 12 μm to 20 μm	3.00
Daily variation 20 μm to 25 μm	3.50

SRM 2055
Serial No. 1-1

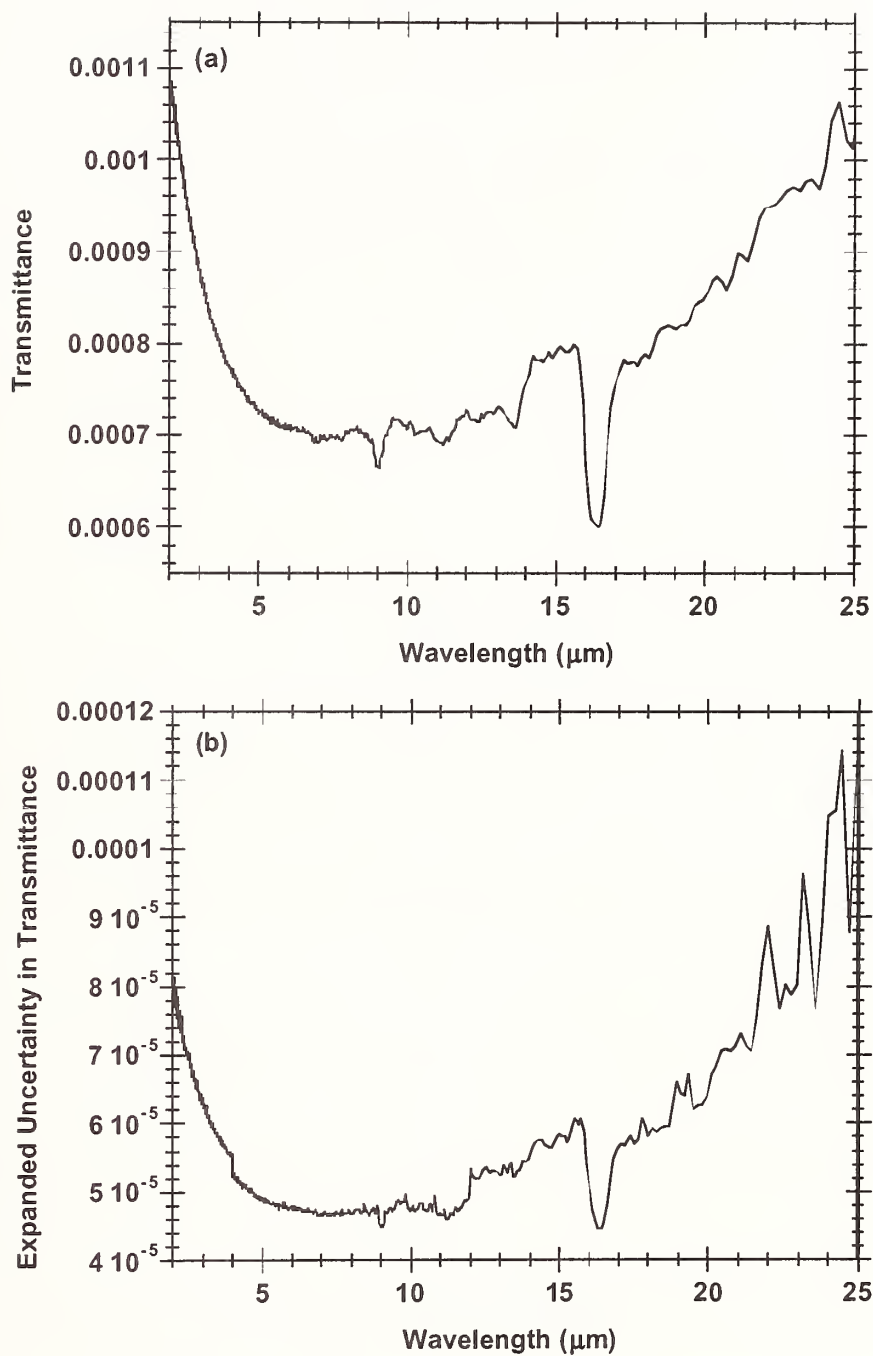

Figure 1. (a) Certified transmittance versus wavelength, and (b) expanded uncertainty in transmittance of the neutral-density filter. The graphs should not be scaled to produce data for the filter. Data should be taken from the file on the accompanying floppy disk.



National Institute of Standards & Technology

Certificate

Standard Reference Material[®] 2056

Infrared Transmittance Standard

Serial No.: 1-1

This Standard Reference Material (SRM) is intended for use in checking the accuracy of the transmittance (ordinate) scale of spectrophotometers in the infrared (IR) spectral region from $2\mu\text{m}$ to $20\mu\text{m}$ (500cm^{-1} to 5000cm^{-1}). SRM 2056 is a neutral-density transmitting filter with an optical density near 4.0 ($\text{OD} = -\log_{10}(T)$, where T is the spectral transmittance). It consists of an approximately 97 nm thick copper-nickel film on a $250\mu\text{m}$ thick, 25 mm diameter, high-resistivity, single-crystal $\langle 100 \rangle$ silicon substrate. The metal film is overcoated with a thin (30nm) layer of silicon oxide to protect it against oxidation from the atmosphere. SRM 2056 also includes a floppy disk that contains the certified transmittance values and associated expanded uncertainties.

Certified Transmittance Values: The transmittance of this filter was measured at equally spaced wavenumber values from 500cm^{-1} to 5000cm^{-1} ($2\mu\text{m}$ to $20\mu\text{m}$) with an apodized resolution of 8cm^{-1} and a data spacing interval of approximately 4cm^{-1} . The transmittance was measured at the center of the filter using a 5 mm diameter spot size with the filter at the focus of an $f/4$ optical beam in the spectrophotometer. The certified transmittance values and associated expanded uncertainties at each wavelength are listed in a text file on the accompanying floppy disk and plotted in Figure 1. These values and their associated uncertainties are valid for normal incidence transmittance within a 5 mm radius of the center of the filter and at temperatures from $20\text{ }^\circ\text{C}$ to $30\text{ }^\circ\text{C}$.

Expiration of Certification: The certification of this SRM is deemed to be valid until **31 December 2001**, provided the SRM is stored and handled in accordance with the Storage and Handling section of this certificate. Certification will be nullified if the SRM is damaged, contaminated, or exposed to excessive temperatures or humidity.

Maintenance of SRM Certification: The neutral-density filter has been measured over a period of approximately one year, and no significant change in transmittance has been noted. A reference filter is kept at NIST and will be monitored over time. Users will be notified if a significant change occurs before the stated expiration date.

The technical measurements leading to certification were performed by S.G. Kaplan and L.M. Hanssen of the NIST Optical Technology Division. The overall direction and coordination of the technical measurements were performed by R.U. Datla of the NIST Optical Technology Division.

Statistical consultation was provided by M.C. Croarkin of the NIST Statistical Engineering Division.

The support aspects involved in the preparation, certification, and issuance of this SRM were coordinated through the NIST Standard Reference Materials Program by J.W.L. Thomas.

Albert C. Parr, Chief
Optical Technology Division

Nancy M. Trahey, Chief
Standard Reference Materials Program

Gaithersburg, MD 20899
Certificate Issue Date: 09 August 2000

Source of Material: The silicon substrates used in making the filters were obtained from Virginia Semiconductor Corporation¹ of Fredericksburg, VA. The metal films were deposited on the substrates by Luxel Corporation¹ of Friday Harbor, WA.

CERTIFICATION ANALYSIS

Measurement Conditions: The calibration measurements were made using a Bomem DA3¹ Fourier transform infrared (FT-IR) spectrophotometer. The temperature in the filter compartment of the instrument was approximately 24 °C, and the spectrophotometer was purged with dry, carbon dioxide free air. A neutral-density filter with optical density near 2 (SRM 2054) was used as the reference in measuring the transmittance of this SRM. The transmittance of the filter under test was calculated from

$$T_{\text{filter}} = T_{\text{relative}} \times T_{\text{reference}} \quad (1)$$

Details of the measurement and analysis can be found in Reference [1].

Determination of Uncertainty in Transmittance: The combined uncertainty includes “Type A” uncertainties, which are evaluated by statistical methods, and “Type B” uncertainties, which are determined by other means. Type A uncertainties include the reproducibility, listed in Table 1, and the repeatability, listed on the accompanying floppy disk. Each filter was measured three times in one day, then removed from the spectrophotometer. A subset of the filters were measured again twice approximately six months after the first set of measurements. Each set of measurements was evaluated for repeatability variance, s_r^2 . The day-to-day variance was also computed for each filter, and no evidence of long-term drift in the measurements was found. The maximum daily variance of all the filter measurements was used as the value of reproducibility variance, s_{days}^2 , which was averaged over several different wavelength bands. Values for a number of systematic (Type B) sources of uncertainty were also estimated (Table 1) and added in quadrature to produce a variance component s_B^2 . The variance in transmittance of the OD 2 reference is $s_{\text{reference}}^2$. The combined uncertainty for the filter was calculated from

$$s_{\text{meas}}^2 = \frac{1}{3} s_r^2 + s_{\text{days}}^2 + s_B^2$$

$$s_{\text{filter}}^2 = \left(\frac{s_{\text{meas}}^2}{T_{\text{filter}}^2} + \frac{s_{\text{reference}}^2}{T_{\text{reference}}^2} \right) \times T_{\text{filter}}^2 \quad (2)$$

The expanded uncertainty (coverage factor of 2) is $2s_{\text{filter}}$. Representative curves for the certified transmittance values and associated expanded uncertainties in transmittance are shown in Figures 1 (a) and (b). The certified values and uncertainties are listed in the data file on the accompanying floppy disk.

INSTRUCTIONS FOR USE

Storage and Handling: The SRM is quite fragile and should be handled with care when mounting and dismounting it from the measurement apparatus. The filter may be handled by wearing clean plastic or thin rubber gloves and holding it gently by the edge. The surfaces should never be touched. Dust can be removed by gently blowing the surface with clean, dry air. When not in use, SRM 2056 should always be kept in its accompanying protective box, which has the SRM serial number engraved on the bottom. It is recommended that the SRM be stored in a dessicator cabinet, if available.

Test Measurements: The spectrophotometer system should be set up under the following conditions. The spectral resolution should ideally be 8 cm^{-1} in order to match that used in the SRM calibration measurements. Lower (i.e., larger cm^{-1} value) resolution may be used and the certified values averaged to match the resolution of the measurement. At resolutions higher than 8 cm^{-1} , Fabry-Perot fringes will appear in the spectrum due to interference

¹ Certain commercial equipment, instruments, or materials are identified in this certificate in order to adequately specify the experimental procedure. Such identification does not imply recommendation or endorsement by the National Institute of Standards and Technology, nor does it imply that the materials or equipment identified are necessarily the best available for this purpose.

in the silicon substrate. In addition, the depth and width of the prominent silicon absorption features near 9 μm and 16 μm wavelengths, and weaker structures at intervening wavelengths, will be affected by choice of resolution. It is recommended that transmittance levels away from these features be used to compare the user's data with the SRM calibration data if the user's resolution is different from 8 cm^{-1} .

The IR beam parallelism may range from collimated up to $f/3$ focusing geometry. The beam should be centered on the filter with a spot size less than 10 mm in diameter. For most FT-IR spectrophotometers, a spot size in the 1 mm to 5 mm diameter range will be most convenient. The average angle of incidence at the filter surface should be less than 6° . The filter should be reproducibly moved in and out of the beam path and the spectra, with and without the filter in place, ratioed to produce a transmittance spectrum. The measurements should be repeated several times in order to assess their reproducibility.

Steps should be taken to reduce the effects of detector nonlinearity, ambient thermal emission, and inter-reflections involving the filter, spectrophotometer, and detector. The magnitude of each of these effects will depend on the user's system and may be reduced by using additional filters and/or stops in the beam path, tilting the filter slightly or blocking half of the beam, and performing additional measurements to test for the effects of ambient thermal emission not coming from the source. A measurement should be made with the beam path at the filter position blocked with an opaque object in order to test for stray light or electronic offset which could produce a false transmittance signal. If a significant signal is found, it should be subtracted from both the filter and reference measurements before ratioing them to obtain the filter transmittance.

Comparison with Certified Values: The primary purpose of this SRM is to check the accuracy of the transmittance (ordinate) scale of the user's spectrophotometer system. In conjunction with SRMs 2053, 2054, and 2055, transmittance measurements of this filter can be used to assess the linearity of the instrument response scale. The user's transmittance spectrum should be compared with the certified values at the wavelength(s) of interest. If the user's values differ from the certified values by less than the quadrature sum of the certified expanded uncertainties and the expanded uncertainty of the mean of the user's values, then the user's values are accurate to this level and no correction should be attempted on the basis of comparison with this SRM.

If the user's measured values differ significantly from the certified values, then additional steps along the lines suggested in the previous section may be taken in order to attempt to improve the transmittance (ordinate) scale accuracy of the instrument. Because of the wide variety of possible spectrophotometer systems and the number and complexity of the various sources of error that may be present in different systems, it is not possible to give a general correction algorithm that will work for all systems. The user of FT-IR systems is referred to the literature on the accuracy of measurements with these instruments [3]. In particular, it should be noted that different types of filters will introduce very different sources of error into the measurements. This SRM is highly reflective and has a transmittance significantly less than 1, so it will tend to reveal errors due to detector nonlinearity and inter-reflections. However, it is optically quite thin and will not yield much difference in the beam geometry, with and without the filter in place, which can be a significant source of error for thicker filters.

REFERENCES

- [1] Kaplan, S.G. and Hanssen, L.M., "Standard Reference Materials: Infrared Transmittance Standards – SRMs 2053, 2054, 2055, and 2056," NIST Special Publication 260-123, In Preparation (2000).
- [2] *Guide to the Expression of Uncertainty in Measurement*, ISBN 92-67-10188-9, 1st Ed. ISO, Geneva, Switzerland, (1993); see also Taylor, B.N. and Kuyatt, C.E., "Guidelines for Evaluating and Expressing Uncertainty of NIST Measurement Results," NIST Technical Note 1297, U.S. Government Printing Office, Washington DC, (1994); available at <http://physics.nist.gov/Pubs/>.
- [3] Kaplan, S.G., Hanssen, L.M., and Datla, R.U., "Testing the radiometric accuracy of Fourier transform infrared transmittance measurements," *Appl. Opt.* **36**, 8896 (1997), and references therein.

Users of this SRM should ensure that the certificate in their possession is current. This can be accomplished by contacting the SRM Program at: telephone (301) 975-6776; fax (301) 926-4751; e-mail srminfo@nist.gov; or via the Internet <http://www.nist.gov/srm>.

Table 1. Standard uncertainty components, in percent of measured transmittance value, for systematic uncertainty sources as well as reproducibility in the measured values.

Uncertainty source	Value (%)
Type B	
Inter-reflections	0.30
Detector nonlinearity	0.05
Detector nonequivalence	0.10
Non-source emission	0.15
Beam nonuniformity	0.20
Beam displacement, deviation, focus shift	0.10
Beam geometry, polarization	0.20
Filter vignetting	0.03
Filter scattering	0.02
Phase errors	0.10
Filter nonuniformity	3.46
Filter temperature	0.20
Quadrature sum, s_B	3.50
Type A (Reproducibility, s_{days})	
Daily variation 2 μm to 4 μm	2.00
Daily variation 4 μm to 12 μm	4.00
Daily variation 12 μm to 20 μm	5.00

SRM 2056
Serial No. 1-1

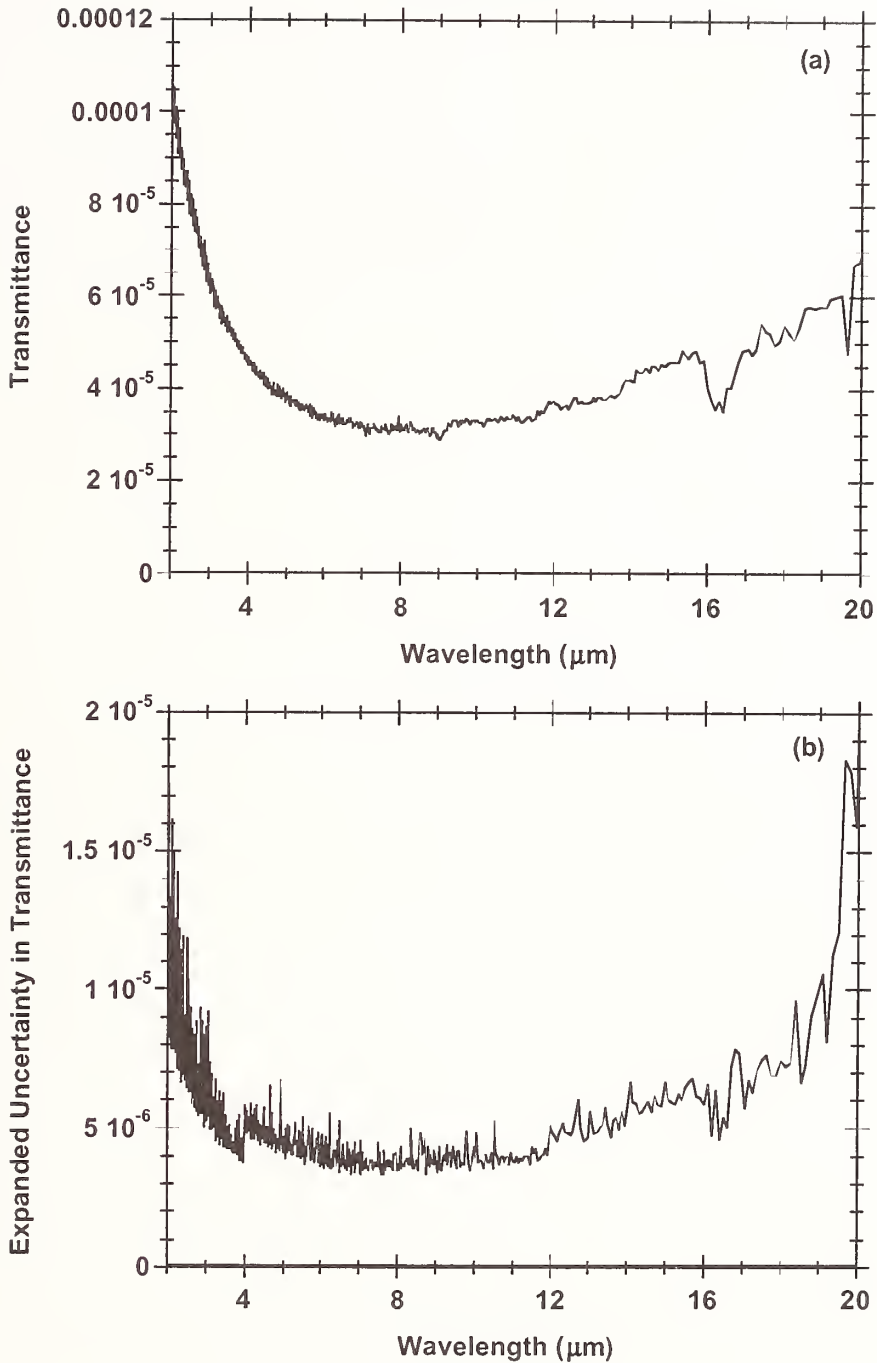

Figure 1. (a) Certified transmittance versus wavelength, and (b) expanded uncertainty in transmittance of the neutral-density filter. The graphs should not be scaled to produce data for the filter. Data should be taken from the file on the accompanying floppy disk.

NIST Technical Publications

Periodical

Journal of Research of the National Institute of Standards and Technology—Reports NIST research and development in those disciplines of the physical and engineering sciences in which the Institute is active. These include physics, chemistry, engineering, mathematics, and computer sciences. Papers cover a broad range of subjects, with major emphasis on measurement methodology and the basic technology underlying standardization. Also included from time to time are survey articles on topics closely related to the Institute's technical and scientific programs. Issued six times a year.

Nonperiodicals

Monographs—Major contributions to the technical literature on various subjects related to the Institute's scientific and technical activities.

Handbooks—Recommended codes of engineering and industrial practice (including safety codes) developed in cooperation with interested industries, professional organizations, and regulatory bodies.

Special Publications—Include proceedings of conferences sponsored by NIST, NIST annual reports, and other special publications appropriate to this grouping such as wall charts, pocket cards, and bibliographies.

National Standard Reference Data Series—Provides quantitative data on the physical and chemical properties of materials, compiled from the world's literature and critically evaluated. Developed under a worldwide program coordinated by NIST under the authority of the National Standard Data Act (Public Law 90-396). NOTE: The Journal of Physical and Chemical Reference Data (JPCRD) is published bimonthly for NIST by the American Institute of Physics (AIP). Subscription orders and renewals are available from AIP, P.O. Box 503284, St. Louis, MO 63150-3284.

Building Science Series—Disseminates technical information developed at the Institute on building materials, components, systems, and whole structures. The series presents research results, test methods, and performance criteria related to the structural and environmental functions and the durability and safety characteristics of building elements and systems.

Technical Notes—Studies or reports which are complete in themselves but restrictive in their treatment of a subject. Analogous to monographs but not so comprehensive in scope or definitive in treatment of the subject area. Often serve as a vehicle for final reports of work performed at NIST under the sponsorship of other government agencies.

Voluntary Product Standards—Developed under procedures published by the Department of Commerce in Part 10, Title 15, of the Code of Federal Regulations. The standards establish nationally recognized requirements for products, and provide all concerned interests with a basis for common understanding of the characteristics of the products. NIST administers this program in support of the efforts of private-sector standardizing organizations.

Order the following NIST publications—FIPS and NISTIRs—from the National Technical Information Service, Springfield, VA 22161.

Federal Information Processing Standards Publications (FIPS PUB)—Publications in this series collectively constitute the Federal Information Processing Standards Register. The Register serves as the official source of information in the Federal Government regarding standards issued by NIST pursuant to the Federal Property and Administrative Services Act of 1949 as amended, Public Law 89-306 (79 Stat. 1127), and as implemented by Executive Order 11717 (38 FR 12315, dated May 11, 1973) and Part 6 of Title 15 CFR (Code of Federal Regulations).

NIST Interagency or Internal Reports (NISTIR)—The series includes interim or final reports on work performed by NIST for outside sponsors (both government and nongovernment). In general, initial distribution is handled by the sponsor; public distribution is handled by sales through the National Technical Information Service, Springfield, VA 22161, in hard copy, electronic media, or microfiche form. NISTIR's may also report results of NIST projects of transitory or limited interest, including those that will be published subsequently in more comprehensive form.

U.S. Department of Commerce
National Institute of Standards
and Technology
Gaithersburg, MD 20899-0001

Official Business
Penalty for Private Use \$300