

NBS  
PUBLICATIONS

NATL INST OF STAND & TECH



A11107 25778



NBS SPECIAL PUBLICATION **260-89**

U.S. DEPARTMENT OF COMMERCE / National Bureau of Standards

*Standard Reference Materials:*

**A Fine-Grained, Isotropic  
Graphite for Use as NBS  
Thermophysical Property  
RM's from 5 to 2500 K**

QC

100

.U57

No. 260-89

1984

c. 2

# T

he National Bureau of Standards<sup>1</sup> was established by an act of Congress on March 3, 1901. The Bureau's overall goal is to strengthen and advance the nation's science and technology and facilitate their effective application for public benefit. To this end, the Bureau conducts research and provides: (1) a basis for the nation's physical measurement system, (2) scientific and technological services for industry and government, (3) a technical basis for equity in trade, and (4) technical services to promote public safety. The Bureau's technical work is performed by the National Measurement Laboratory, the National Engineering Laboratory, the Institute for Computer Sciences and Technology, and the Center for Materials Science.

## *The National Measurement Laboratory*

Provides the national system of physical and chemical measurement; coordinates the system with measurement systems of other nations and furnishes essential services leading to accurate and uniform physical and chemical measurement throughout the Nation's scientific community, industry, and commerce; provides advisory and research services to other Government agencies; conducts physical and chemical research; develops, produces, and distributes Standard Reference Materials; and provides calibration services. The Laboratory consists of the following centers:

- Basic Standards<sup>2</sup>
- Radiation Research
- Chemical Physics
- Analytical Chemistry

## *The National Engineering Laboratory*

Provides technology and technical services to the public and private sectors to address national needs and to solve national problems; conducts research in engineering and applied science in support of these efforts; builds and maintains competence in the necessary disciplines required to carry out this research and technical service; develops engineering data and measurement capabilities; provides engineering measurement traceability services; develops test methods and proposes engineering standards and code changes; develops and proposes new engineering practices; and develops and improves mechanisms to transfer results of its research to the ultimate user. The Laboratory consists of the following centers:

- Applied Mathematics
- Electronics and Electrical Engineering<sup>2</sup>
- Manufacturing Engineering
- Building Technology
- Fire Research
- Chemical Engineering<sup>2</sup>

## *The Institute for Computer Sciences and Technology*

Conducts research and provides scientific and technical services to aid Federal agencies in the selection, acquisition, application, and use of computer technology to improve effectiveness and economy in Government operations in accordance with Public Law 89-306 (40 U.S.C. 759), relevant Executive Orders, and other directives; carries out this mission by managing the Federal Information Processing Standards Program, developing Federal ADP standards guidelines, and managing Federal participation in ADP voluntary standardization activities; provides scientific and technological advisory services and assistance to Federal agencies; and provides the technical foundation for computer-related policies of the Federal Government. The Institute consists of the following centers:

- Programming Science and Technology
- Computer Systems Engineering

## *The Center for Materials Science*

Conducts research and provides measurements, data, standards, reference materials, quantitative understanding and other technical information fundamental to the processing, structure, properties and performance of materials; addresses the scientific basis for new advanced materials technologies; plans research around cross-country scientific themes such as nondestructive evaluation and phase diagram development; oversees Bureau-wide technical programs in nuclear reactor radiation research and nondestructive evaluation; and broadly disseminates generic technical information resulting from its programs. The Center consists of the following Divisions:

- Inorganic Materials
- Fracture and Deformation<sup>3</sup>
- Polymers
- Metallurgy
- Reactor Radiation

<sup>1</sup>Headquarters and Laboratories at Gaithersburg, MD, unless otherwise noted; mailing address Gaithersburg, MD 20899.

<sup>2</sup>Some divisions within the center are located at Boulder, CO 80303.

<sup>3</sup>Located at Boulder, CO, with some elements at Gaithersburg, MD.

*Standard Reference Materials:*

NATIONAL BUREAU  
OF STANDARDS  
LIBRARY

QC100  
.U57  
NO. 260-89  
1984  
C.2

# A Fine-Grained, Isotropic Graphite for Use as NBS Thermophysical Property RM's from 5 to 2500 K

Jerome G. Hust

Center for Chemical Engineering  
National Engineering Laboratory  
National Bureau of Standards  
Boulder, CO 80303

Sponsored by:  
Office of Standard Reference Materials  
National Measurement Laboratory  
National Bureau of Standards  
Gaithersburg, MD 20899



*NBS Special Publication*

U.S. DEPARTMENT OF COMMERCE, Malcolm Baldrige, Secretary

NATIONAL BUREAU OF STANDARDS, Ernest Ambler, Director

Issued September 1984

Library of Congress Catalog Card Number: 84-601106

National Bureau of Standards Special Publication 260-89  
Natl. Bur. Stand. (U.S.), Spec. Publ. 260-89, 116 pages (Sept. 1984)  
CODEN: XNBSAV

U.S. GOVERNMENT PRINTING OFFICE

WASHINGTON: 1984

---

For sale by the Superintendent of Documents, U.S. Government Printing Office, Washington, DC 20402

## PREFACE

Standard Reference Materials (SRM's) as defined by the National Bureau of Standards are "well-characterized materials, produced in quantity, that calibrate a measurement system to assure compatibility of measurement in the Nation." SRM's are widely used as primary standards in many diverse fields of science, industry, and technology, both within the United States and throughout the world. For many of the Nation's scientists and technologists it is of more than passing interest to know the measurements obtained and methods used by the analytical community when analyzing SRM's. An NBS series of papers, of which this publication is a member, called the NBS Special Publication - 260 Series is reserved for this purpose.

This 260 Series is dedicated to the dissemination of elemental concentration data for NBS biological, geological, and environmental SRM's. More information will be found in this 260 than is generally found in NBS Certificate of Analysis. This 260 enables the user of these SRM's to assess the validity of data not available in the Certificate of Analysis. We hope that this 260 will provide sufficient additional information so that new applications of these SRM's may be sought and found.

Inquiries concerning the technical content of this compilation should be directed to the authors. Other questions concerned with the availability, delivery, price of specific SRM's should be addressed to:

Office of Standard Reference Materials  
National Bureau of Standards  
Gaithersburg, MD 20899

Stanley D. Rasberry, Chief  
Office of Standard Reference Materials



## OTHER NBS PUBLICATIONS IN THIS SERIES

- Catalog of NBS Standard Reference Materials (1981-83 edition), R. W. Seward, ed., NBS Spec. Publ. 260 (November 1981).
- Michaelis, R. E., and Wyman, L. L. Standard Reference Materials: Preparation of White Cast Iron Spectrochemical Standards. NBS Misc. Publ. 260-1 (June 1964). COM74-11061\*\*
- Michaelis, R. E., Wyman, L. L., and Flitsch, R., Standard Reference Materials: Preparation of NBS Copper-Base Spectrochemical Standards. NBS Misc. Publ. 260-2 (October 1964). COM74-11063\*\*
- Michaelis, R. E., Yakowitz, H., and Moore, G. A., Standard Reference Materials: Metallographic Characterization of an NBS Spectrometric Low-Alloy Steel Standard. NBS Misc. Publ. 260-3 (October 1964). COM74-11060\*\*
- Hague, J. L. Mears, T. W., and Michaelis, R. E., Standard Reference Materials: Sources of Information, NBS Misc. Publ. 260-4 (February 1965). COM74-11059
- Alvarez, R., and Flitsch R., Standard Reference Materials: Accuracy of Solution X-Ray Spectrometric Analysis of Copper-Base Alloys. NBS Misc. Publ. 260-5 (March 1965). PB168068\*\*
- Shultz, J. I., Standard Reference Materials: Methods for the Chemical Analysis of White Cast Iron Standards, NBS Misc. Publ. 260-6 (July 1975). COM74-11068\*\*
- Bell, R. K., Standard Reference Materials: Methods for the Chemical Analysis of NBS Copper-Base Spectrochemical Standards. NBS Misc. Publ. 260-7 (October 1965). COM74-11067\*\*
- Richmond, M.S., Standard Reference Materials: Analysis of Uranium Concentrates at the National Bureau of Standards. NBS Misc. Publ. 260-8 (December 1965). COM74-11066\*\*
- Anspach, S. C., Cavallo, L. M. Garfinkel, S. B. Hutchinson, J. M. R., and Smith, C. N., Standard Reference Materials: Half Lives of Materials Used in the Preparation of Standard Reference Materials of Nineteen Radioactive Nuclides Issued by the National Bureau of Standards NBS Misc. Publ. 260-9 (November 1965). COM74-11065\*\*
- Yakowitz, H., Vieth, D. L., Heinrich, K. F. J., and Michaelis, R. E., Standard Reference Materials: Homogeneity Characterization on NBS Spectrometric Standards II: Cartridge Brass and Low-Alloy Steel, NBS Misc. Publ. 260-10 (December 1965). COM74-11064\*\*
- Napolitano, A., and Hawkins, E. G., Standard Reference Materials: Viscosity of Standard Lead-Silica Glass, NBS Misc. Publ. 260-11 (November 1966). NBS Misc. Publ. 260-11\*\*
- Yakowitz, H., Vieth, D. L., and Michaelis, R. E., Standard Reference Materials: Homogeneity Characterization of NBS Spectrometric Standards III: White Cast Iron and Stainless Steel Powder Compact, NBS Misc. Publ. 260-12 (September 1966). NBS Misc. Publ. 260-12\*\*
- Spijkerman, J. L., Snediker, D. K., Ruegg, F. C., and DeVoe, J. R., Standard Reference Materials: Mossbauer Spectroscopy Standard for the Chemical Shift of Iron Compounds, NBS Misc. Publ. 260-13 (July 1967). NBS Misc. Publ. 260-13\*\*
- Menis, O., and Sterling, J. T., Standard Reference Materials: Determination of Oxygen in Ferrous Materials - SRM 1090, 1091, and 1092, NBS Misc. Publ. 260-14 (September 1966). NBS Misc. Publ. 260-14\*\*
- Passaglia, E., and Shouse, P. J. Standard Reference Materials: Recommended Method of Use of Standard Light-Sensitive Paper for Calibrating Carbon Arcs Used in Testing Textiles for Colorfastness to Light, NBS Misc. Publ. 260-15 (June 1967). (Replaced by NBS Spec. Publ. 260-41.)
- Yakowitz, H., Michaelis, R. E., and Vieth, D. L., Standard Reference Materials: Homogeneity Characterization of NBS Spectrometric Standards IV: Preparation and Microprobe Characterization of W-20% MO Alloy Fabricated by Powder Metallurgical Methods, NBS Spec. Publ. 260-16 (January 1969). COM74-11062\*\*
- Catanzaro, E. J., Champion, C. E., Garner, E. L., Marinenko, G., Sappenfield, K. M., and Shields, W. R. Standard Reference Materials: Boric Acid; Isotopic and Assay Standard Reference Materials, NBS Spec. Publ. 260-17 (February 1970). Out of Print

- Geller, S. B., Mantek, P.A., and Cleveland, N. G., Standard Reference Materials: Calibration of NBS Secondary Standard Magnetic Tape (Computer Amplitude Reference) Using the Reference Tape Amplitude Measurement "Process A," NBS Spec. Publ. 260-18 (November 1969). (See NBS Spec. Publ. 260-29.)
- Paule, R. C., and Mandel, J., Standard Reference Materials: Analysis of Interlaboratory Measurements on the Vapor Pressure of Gold (Certification of Standard Reference Material 745). NBS Spec. Publ. 260-19 (January 1970). PB190071\*\*
- Paule, R. C., and Mandel, J., Standard Reference Materials: Analysis of Interlaboratory Measurements on the Vapor Pressures of Cadmium and Silver, NBS Spec. Publ. 260-21 (January 1971). COM74-11359\*\*
- Yakowitz, H., Fiori, C. E., and Michaelis, R. E., Standard Reference Materials: Homogeneity Characterization of Fe-3 Si Alloy, NBS Spec. Publ. 260-22 (February 1971). COM74-11357\*\*
- Napolitano, A., and Hawkins, E. G., Standard Reference Materials: Viscosity of a Standard Borosilicate Glass, NBS Spec. Publ. 260-23 (December 1970). COM71-00157\*\*
- Sappenfield, K. M., Marineko, G., and Hague, J. L., Standard Reference Materials: Comparison of Redox Standards, NBS Spec. Publ. 260-24 (January 1972). COM72-50058\*\*
- Hicho, G. E., Yakowitz, H., Rasberry, S. D., and Michaelis, R. E., Standard Reference Materials: A Standard Reference Material Containing Nominally Four Percent Austenite, NBS Spec. Publ. 260-25 (February 1971). COM74-11356\*\*
- Martin, J. F., Standard Reference Materials: National Bureau of Standards-US Steel Corporation Joint Program for Determining Oxygen and Nitrogen in Steel, NBS Spec. Publ. 260-26 (February 1971). 85 cents\* PB 81176620
- Garner, E. L., Machlan, L. A., and Shields, W. R., Standard Reference Materials: Uranium Isotopic Standard Reference Materials, NBS Spec. Publ. 260-27 (April 1971). COM74-11358\*\*
- Heinrich, K. F. J., Myklebust, R. L., Rasberry, S. D., and Michaelis, R. E., Standard Reference Materials: Preparation and Evaluation of SRM's 481 and 482 Gold-Silver and Gold-Copper Alloys for Microanalysis, NBS Spec. Publ. 260-28 (August 1971). COM71-50365\*\*
- Geller, S. B., Standard Reference Materials: Calibration of NBS Secondary Standard Magnetic Tape (Computer Amplitude Reference) Using the Reference Tape Amplitude Measurement "Process A-Model 2," NBS Spec. Publ. 260-29 (June 1971). COM71-50282
- Gorozhanina, R. S., Freedman, A. Y., and Shaievitch, A. B. (translated by M. C. Selby), Standard Reference Materials: Standard Samples Issued in the USSR (A Translation from the Russian). NBS Spec. Publ. 260-30 (June 1971). COM71-50283\*\*
- Hust, J. G., and Sparks, L. L., Standard Reference Materials: Thermal Conductivity of Electrolytic Iron SRM 734 from 4 to 300 K, NBS Spec. Publ. 260-31 (November 1971). COM71-50563\*\*
- Mavrodineanu, R., and Lazar, J. W., Standard Reference Materials: Standard Quartz Cuvettes, for High Accuracy Spectrophotometry, NBS Spec. Publ. 260-32 (December 1973). 55 cents\* SN003-003-01213-1
- Wagner, H. L., Standard Reference Materials: Comparison of Original and Supplemental SRM 705, Narrow Molecular Weight Distribution Polystyrene, NBS Spec. Publ. 260-33 (May 1972). COM72-50526\*\*
- Sparks, L. L., and Hust, J. G., Standard Reference Materials: Thermoelectric Voltage, NBS Spec. Publ. 260-34, (April 1972). COM72-50371\*\*
- Sparks, L. L., and Hust, J. G., Standard Reference Materials: Thermal Conductivity of Austenitic Stainless Steel, SRM 735 from 5 to 280 K, NBS Spec. Publ. 260-35 (April 1972). 35 cents\* COM72-50368\*\*
- Cali, J. P., Mandel, J., Moore, L. J., and Young, D. S., Standard Reference Materials: A Referee Method for the Determination of Calcium in Serum, NBS SRM 915, NBS Spec. Publ. 260-36 (May 1972). COM72-50527\*\*
- Shultz, J. I. Bell., R. K. Rains, T. C., and Menis, O., Standard Reference Materials: Methods of Analysis of NBS Clay Standards, NBS Spec. Publ. 260-37 (June 1972). COM72-50692\*\*
- Richmond, J. C., and Hsia, J. J., Standard Reference Materials: Preparation and Calibration of Standards of Spectral Specular Reflectance, NBS Spec. Publ. 260-38 (May 1972). COM72-50528\*\*
- Clark, A. F., Denson, V.A., Hust, J. G., and Powell, R. L., Standard Reference Materials The Eddy Current Decay Method for Resistivity Characterization of High-Purity Metals, NBS Spec. Publ. 260-39 (May 1972). COM72-50529\*\*

- McAdie, H. G., Garn, P.D., and Menis, O., Standard Reference Materials: Selection of Thermal Analysis Temperature Standards Through a Cooperative Study (SRM 758, 759, 760), NBS Spec. Publ. 260-40 (August 1972.) COM72-50776\*\*
- Wood, L. A., and Shouse, P. J., Standard Reference Materials: Use of Standard Light-Sensitive Paper for Calibrating Carbon Arcs Used in Testing Textiles for Colorfastness to Light, NBS Spec. Publ. 260-41 (August 1972) COM72-50775\*\*
- Wagner, H. L. and Verdier, P. H., eds., Standard Reference Materials: The Characterization of Linear Polyethylene, SRM 1475, NBS Spec. Publ. 260-42 (September 1972). COM72-50944\*\*
- Yakowitz, H., Ruff, A. W., and Michaelis, R. E., Standard Reference Materials: Preparation and Homogeneity Characterization of an Austenitic Iron-Chromium-Nickel Alloy, NBS Spec. Publ. 260-43 (November 1972). COM73-50760\*\*
- Schooley, J. F., Soulen, R. J., Jr., and Evans, G. A., Jr., Standard Reference Materials: Preparation and Use of Superconductive Fixed Point Devices, SRM 767, NBS Spec. Publ. 260-44 (December 1972). COM73-50037\*\*
- Greifer, B., Maienthal, E. J. Rains, T. C., and Rasberry, S. D., Standard Reference Materials: Powdered Lead-Based Paint, SRM 1579, NBS Spec. Publ. 260-45 (March 1973). COM73-50226\*\*
- Hust, J. G., and Giarratano, P. J., Standard Reference Materials: Thermal Conductivity and Electrical Resistivity Standard Reference Materials: Austenitic Stainless Steel, SRM's 735 and 798, from 4 to 1200 K, NBS Spec. Publ. 260-46 (March 1975). SN003-003-01278-5
- Hust, J. G., Standard Reference Materials: Electrical Resistivity of Electrolytic Iron, SRM 797, and Austenitic Stainless Steel, SRM 798, from 5 to 280 K, NBS Spec. Publ. 260-47 (February 1974). COM74-50176\*\*
- Mangum, B. W., and Wise, J. A., Standard Reference Materials: Description and Use of Precision Thermometers for the Clinical Laboratory, SRM 933 and SRM 934, NBS Spec. Publ. 260-48 (May 1974). 60 cents\* SN003-003-01278-5
- Carpenter, B. S., and Reimer, G. M., Standard Reference Materials Calibrated Glass Standards for Fission Track Use, NBS Spec. Publ. 260-49 (November 1974). COM74-51185
- Hust, J. G., and Giarratano, P. J., Standard Reference Materials: Thermal Conductivity and Electrical Resistivity Standard Reference Materials: Electrolytic Iron, SRM's 734 and 797 from 4 to 1000 K, NBS Spec. Publ. 260-50 (June 1975). \$1.00\* SN003-003-01425-7
- Mavrodineanu, R., and Baldwin, J. R., Standard Reference Materials: Glass Filters As a Standard Reference Material for Spectrophotometry; Selection; Preparation; Certification; Use-SRM 930, NBS Spec. Publ. 260-51 (November 1975). \$1.90\* SN003-003-01481-8
- Hust, J. G., and Giarratano, P. J., Standard Reference Materials: Thermal Conductivity and Electrical Resistivity Standard Reference Materials 730 and 799, from 4 to 3000 K, NBS Spec. Publ. 260-52 (September 1975). \$1.05\* SN003-003-01464-8
- Durst, R. A., Standard Reference Materials: Standardization of pH Measurements, NBS Spec. Publ. 260-53 (December 1975, Revised). \$1.05 SN003-003-01551-2
- Burke, R. W., and Mavrodineanu, R. Standard Reference Materials: Certification and Use of Acidic Potassium Dichromate Solutions as an Ultraviolet Absorbance Standard, NBS Spec. Publ. 260-54 (August 1977). \$3.00\* SN003-003-01828-7
- Ditmars, D. A., Cezairliyan, A., Ishihara, S., and Douglas, T. B., Standard Reference Materials: Enthalpy and Heat Capacity; Molybdenum SRM 781, from 273 to 2800 K, NBS Spec. Publ. 260-55 (September 1977). \$2.20\* SN003-003-01836-8
- Powell, R. L., Sparks, L. L., and Hust, J. G., Standard Reference Materials: Standard Thermocouple Materials, Pt.67: SRM 1967, NBS Spec. Publ. 260-56 (February 1978). \$2.20\* SN003-003-018864
- Cali, J. P. and Plebanski, T., Guide to United States Reference Materials, NBS Spec. Publ. 260-57 (February 1978). \$2.20\* PB 277173
- Barnes, J. D., and Martin, G. M., Standard Reference Materials: Polyester Film for Oxygen Gas Transmission Measurements SRM 1470, NBS Spec. Publ. 260-58 (June 1979) \$2.00\* SN003-003-02077
- Chang, T., and Kahn, A. H. Standard Reference Materials: Electron Paramagnetic Resonance Intensity Standard; SRM 2601, NBS Spec. Publ. 260-59 (August 1978) \$2.30\* SN003-003-01975-5



- Velapoldi, R. A., Paule, R. C., Schaffer, R., Mandel, J., and Moody, J. R., Standard Reference Materials: A Reference Method for the Determination of Sodium in Serum, NBS Spec. Publ. 260-60 (August 1978). \$3.00\* SN003-003 01978-0
- Verdier, P. H., and Wagner, H. L., Standard Reference Materials: The Characterization of Linear Polyethylene (SRM 1482, 1483, 1484), NBS Spec. Publ. 260-61 (December 1978). \$1.70\* SN003-003-02006-1
- Soulen, R. J., and Dove, R. B., Standard Reference Materials: Temperature Reference Standard for Use Below 0.5 K (SRM 768). NBS Spec. Publ. 260-62 (April 1979). \$2.30\* SN003-003-02047-8
- Velapoldi, R. A., Paule, R. C., Schaffer, R., Mandel, J., Machlan, L. A., and Gramlich, J. W., Standard Reference Materials: A Reference Method for the Determination of Potassium in Serum. NBS Spec. Publ. 260-63 (May 1979). \$3.75\* SN003-003-02068
- Velapoldi, R. A., and Mielenz, K. D., Standard Reference Materials: A Fluorescence Standard Reference Material Quinine Sulfate Dihydrate (SRM 936), NBS Spec. Publ. 260-64 (January 1980). \$4.25\* SN003-003-02148-2
- Marinenko, R. B., Heinrich, K. F. J., and Ruegg, F. C., Standard Reference Materials: Micro-Homogeneity Studies of NBS Standard Reference Materials, NBS Research Materials, and Other Related Samples. NBS Spec. Publ. 260-65 (September 1979). \$3.50\* SN003-003-02114-1
- Venable, W. H., Jr., and Eckerle, K. L., Standard Reference Materials: Didymium Glass Filters for Calibrating the Wavelength Scale of Spectrophotometers (SRM 2009, 2010, 2013). NBS Spec. Publ. 260-66 (October 1979). \$3.50\* SN003-003-02127-0
- Velapoldi, R. A., Paule, R. C., Schaffer, R., Mandel, J., Murphy, T. J., and Gramlich, J. W., Standard Reference Materials: A Reference Method for the Determination of Chloride in Serum, NBS Spec. Publ. 260-67 (November 1979). \$3.75\* SN003-003-02136-9
- Mavrodineanu, R. and Baldwin, J. R., Standard Reference Materials: Metal-On-Quartz Filters as a Standard Reference Material for Spectrophotometry-SRM 2031, NBS Spec. Publ. 260-68 (April 1980). \$4.25\* SN003-003-02167-9
- Velapoldi, R. A., Paule, R. C., Schaffer, R., Mandel, J., Machlan, L. A., Garner, E. L., and Rains, T. C., Standard Reference Materials: A Reference Method for the Determination of Lithium in Serum, NBS Spec. Publ. 260-69 (July 1980). \$4.25\* SN003-003-02214-4
- Marinenko, R. B., Biancianiello, F., Boyer, P. A., Ruff, A. W., DeRobertis, L., Standard Reference Materials: Preparation and Characterization of an Iron-Chromium-Nickel Alloy for Microanalysis, NBS Spec. Publ. 260-70 (May 1981). \$2.50\* SN003-003-02328-1
- Seward, R. W., and Mavrodineanu, R., Standard Reference Materials: Summary of the Clinical Laboratory Standards Issued by the National Bureau of Standards, NBS Spec. Publ. 260-71 (November 1981). \$6.50\* SN003-003-02381-7
- Reeder, D.J., Coxon, B., Enagonio, D., Christensen, R. G., Schaffer, R., Howell, B. F., Paule, R. C., Mandel, J., Standard Reference Materials: SRM 900, Antiepilepsy Drug Level Assay Standard, NBS Spec. Publ. 260-72 (June 1981). \$4.25\* SN003-003-02329-9
- Interrante, C. G., and Hicho, G. E., Standard Reference Materials: A Standard Reference Material Containing Nominally Fifteen Percent Austenite (SRM 486), NBS Spec. Publ. 260-73 (January 1982). \$2.75\* SN003-003-02386-8
- Marinenko, R. B., Standard Reference Materials: Preparation and Characterization of K-411 and K-414 Mineral Glasses for Microanalysis: SRM 470. NBS Spec. Publ. 260-74 (April 1982). \$3.50 SN003-003-023-95-7
- Weidner, V. R., Hsia, J. J., Standard Reference Materials: Preparation and Calibration of First Surface Aluminum Mirror Specular Reflectance Standards (SRM 2003a), NBS Spec. Publ. 260-75 (May 1982). \$3.75 SN003-003-023-99-0
- Hicho, G. E. and Eaton, E. E., Standard Reference Materials: A Standard Reference Material Containing Nominally Five Percent Austenite (SRM 485a), NBS Spec. Publ. 260-76 (August 1982). \$3.50 SN003-003-024-33-3
- Furukawa, G. T., Riddle, J. L., Bigge, W. G., and Pfeiffer, E. R., Standard Reference Materials: Application of Some Metal SRM's as Thermometric Fixed Points, NBS Spec. Publ. 260-77 (August 1982). \$6.00 SN003-003-024-34-1

- Hicho, G. E. and Eaton, E. E., Standard Reference Materials: Standard Reference Material Containing Nominally Thirty Percent Austenite (SRM 487), NBS Spec. Publ. 260-78 (September 1982). \$3.75 SN003-003-024-35-0
- Richmond, J. C., Hsia, J. J. Weidner, V. R., and Wilmering, D. B., Standard Reference Materials: Second Surface Mirror Standards of Specular Spectral Reflectance (SRM's 2023, 2024, 2025), NBS Spec. Publ. 260-79 (October 1982). \$4.50 SN003-003-024-47-3
- Schaffer, R., Mandel, J., Sun, T., Cohen, A., and Hertz, H. S., Standard Reference Materials: Evaluation by and ID/MS Method of the AACC Reference Method for Serum Glucose, NBS Spec. Publ. 260-80 (October 1982). \$4.25 SN003-003-024-43-1
- Burke, R. W., Mavrodineanu, R. (NBS retired), Standard Reference Materials: Accuracy in Analytical Spectrophotometry, NBS Spec. Publ. 260-81 (April 1983). \$6.00 SN003-003-024-84-8
- Weidner, V. R., Standard Reference Materials: White Opal Glass Diffuse Spectral Reflectance Standards for the Visible Spectrum (SRM's 2015 and 2016), NBS Spec. Publ. 260-82 (April 1983). \$3.75 SN-003-003-024-89-9
- Bowers, G. N., Jr., Alvarez, R., Cali, J. P. (NBS retired), Eberhardt, K. R., Reeder, D. J., Schaffer, R., Uriano, G. A., Standard Reference Materials: The Measurement of the Catalytic (Activity) Concentration of Seven Enzymes in NBS Human Serum SRM 909, NBS Spec. Publ. 260-83 (June 1983). \$4.50 SN003-003-024-99-6
- Gills, T. E., Seward, R. W., Collins, R. J., and Webster, W. C., Standard Reference Materials: Sampling, Materials Handling, Processing, and Packaging of NBS Sulfur in Coal Standard Reference Materials, 2682, 2683, 2684, and 2685, NBS Spec. Publ. 260-84 (August 1983). \$4.50 SN003-003-025-20-8
- Swyt, D. A., Standard Reference Materials: A Look at Techniques for the Dimensional Calibration of Standard Microscopic Particles, NBS Spec. Publ. 260-85 (September 1983). \$5.50 SN003-003-025-21-6
- Hicho, G. E. and Eaton, E. E., Standard Reference Materials: A Standard Reference Material Containing Two and One-Half Percent Austenite, SRM 488, NBS Spec. Publ. 260-86 (December 1983). \$1.75\* SN003-003-025-41-1
- Mangum, B. W., Standard Reference Materials: SRM 1969: Rubidium Triple-Point - A Temperature Reference Standard Near 39.30 °C, NBS Spec. Publ. 260-87 (December 1983). \$2.25\* SN003-003-025-44-5
- Gladney, E. S., Burns, C. E., Perrin, D. R., Roelandts, I., and Gills, T. E., 1982 Compilation of Elemental Concentration Data for NBS Biological, Geological, and Environmental Standard Reference Materials. NBS Spec. Publ. 260-88 (March 1984). SN003-003-02565-8
- Hust, J. G., A Fine-Grained, Isotropic Graphite for Use as NBS Thermophysical Property RM's from 5 to 2500 K, NBS Spec. Publ. 260-89 (In Press).
- \* Send order with remittance to superintendent's Office of Documents, US Government Printing Office Washington, DC 20402. Remittance from foreign countries should include an additional one-fourth of the purchase price for postage.
- \*\* May be ordered from: National Technical Information Services (NTIS). Springfield Virginia 22151.

# CONTENTS

	Page
1. INTRODUCTION . . . . .	3
2. PHASE I. PRELIMINARY ELECTRICAL RESISTIVITY AND DENSITY CHARACTERIZATION . . . . .	4
2.1 Specimen Preparation . . . . .	4
2.2 Measurements . . . . .	5
2.3 Results and Discussion . . . . .	7
2.4 Other Graphites . . . . .	14
2.5 Conclusions and Recommendations . . . . .	21
2.6 Summary of Phase I . . . . .	21
3. PHASE II. PRELIMINARY THERMAL CONDUCTIVITY CHARACTERIZATION . . . . .	22
3.1 Measurements . . . . .	22
3.2 Correlations . . . . .	25
3.3 Conclusions and Recommendations . . . . .	29
4. PHASE III. COOPERATIVE MEASUREMENTS . . . . .	31
4.1 Specimen Characterization . . . . .	31
4.2 Specimen Distribution and Results . . . . .	32
5. PHASE IV. DATA ANALYSIS AND RECOMMENDED VALUES . . . . .	52
5.1 Thermal Conductivity . . . . .	52
5.2 Electrical Resistivity . . . . .	75
5.3 Specific Heat . . . . .	79
5.4 Thermal Diffusivity . . . . .	86
5.5 Thermal Expansion . . . . .	94
5.6 Seebeck Coefficient . . . . .	95
6. ACKNOWLEDGEMENTS . . . . .	95
7. REFERENCES . . . . .	98

LIST OF TABLES

	Page
Table 1. Resistivity and density data for AXM-5Q1 graphite specimens . . . . .	6
Table 2. Resistivity and density data for AXM-5Q and 9Q1 graphite specimens . . . . .	16
Table 3. Thermal conductivity, electrical resistivity, density and Lorenz ratio for thirteen AXM graphite specimens . . . . .	24
Table 4. Densities of 30 cm long AXM-5Q1 graphite rods at 20 °C . . . . .	33
Table 5. Summary of reported results on AXM-5Q1 graphite . . . . .	51
Table 6. Thermophysical properties for AXM-5Q1 graphite as reported by Brandt (6) . . . . .	53
Table 7. Thermophysical properties for AXM-5Q1 graphite as reported by participant 1, spec. 62, room temperature electrical resistivity = $12.40 \mu\Omega\cdot m$ , density = $1757 \text{ kg}\cdot\text{m}^{-3}$ . . . . .	53
Table 8. Thermophysical properties for AXM-5Q1 graphite as reported by Hust (7) . . . . .	54
Table 9. Thermophysical properties for AXM-5Q1 graphite as reported by Hust (7) . . . . .	55
Table 10. Thermophysical properties for AXM-5Q1 graphite as reported by Isaacs (8), spec. 103-2, room temperature electrical resistivity = $15.49 \mu\Omega\cdot m$ , density = $1721 \text{ kg}\cdot\text{m}^{-3}$ . . . . .	56
Table 11. Thermophysical properties for AXM-5Q1 graphite as reported by Maglic (9), spec. 4, room temperature electrical resistivity = $14.59 \mu\Omega\cdot m$ , density = $1755 \text{ kg}\cdot\text{m}^{-3}$ . . . . .	56
Table 12. Thermophysical properties for AXM-5Q1 graphite as reported by Mirkovich (10), spec. 112B, room temperature electrical resistivity = $15.00 \mu\Omega\cdot m$ , density = $1724 \text{ kg}\cdot\text{m}^{-3}$ . . . . .	56
Table 13. Thermophysical properties for AXM-5Q1 graphite as reported by Moore (11), spec. 102, room temperature electrical resistivity = $12.60 \mu\Omega\cdot m$ , density = $1770 \text{ kg}\cdot\text{m}^{-3}$ . . . . .	57
Table 14. Thermophysical properties for AXM-5Q1 graphite as reported by participant 5 . . . . .	57
Table 15. Thermophysical properties for AXM-5Q1 graphite as reported by participant 2, spec. 41B, room temperature electrical resistivity = $18.81 \mu\Omega\cdot m$ , density = $1706 \text{ kg}\cdot\text{m}^{-3}$ . . . . .	58

Table 16. Thermophysical properties for AXM-5Q1 graphite as reported by participant 3, spec. 52, room temperature electrical resistivity = $13.39 \mu\Omega\cdot\text{m}$ , density = $1738 \text{ kg}\cdot\text{m}^{-3}$ . . . . .	58
Table 17. Thermophysical properties for AXM-5Q1 graphite as reported by Taylor (12) . . . . .	59
Table 18. Thermophysical properties for AXM-5Q1 graphite as reported by Taylor (13) . . . . .	60
Table 19. Thermophysical properties for AXM-5Q1 graphite as reported by participant 4, spec. 111-end 1, room temperature electrical resistivity = $15.00 \mu\Omega\cdot\text{m}$ , density = $1666 \text{ kg}\cdot\text{m}^{-3}$ . . . . .	60
Table 20. Thermophysical properties for AXM-5Q1 graphite as calculated from the equations indicated in this report, for room temperature electrical resistivity = $14.5 \mu\Omega\cdot\text{m}^{-3}$ and density = $1730 \text{ kg}/\text{m}^3$ . . . . .	74



LIST OF FIGURES

	Page
Figure 1. Electrical resistivity as a function of temperature of nine AXM graphite specimens . . . . .	8
Figure 2. Electrical resistivity as a function of temperature of ten AXM graphite specimens. Four specimens taken from a single 25.4 mm diameter NBS rod and six specimens taken from a single AFML slab to illustrate short range inhomogeneity . .	9
Figure 3. Electrical resistivity as a function of temperature of twelve AXM graphite specimens . . . . .	10
Figure 4. Electrical resistivity versus density of AXM graphite specimens at 4 K (solid lines indicate intra-rod correlation) . . . . .	11
Figure 5. Electrical resistivity versus density of AXM graphite specimens at 76 K (solid lines indicate intra-rod correlation) . . . . .	12
Figure 6. Electrical resistivity versus density of AXM graphite specimens at 273 K (solid lines indicate intra-rod correlation) . . . . .	13
Figure 7. Electrical resistivity versus density of AXM graphite specimens at 293 K. Data obtained at SoRI prior to and after anneal at 3180 °C for one hour. Arrows point to post-anneal data . . . . .	15
Figure 8. Electrical resistivity versus position along an AXM-5Q and AXM-9Q1 graphite rod at 76 K . . . . .	17
Figure 9. Density versus position along an AXM-5Q and AXM-9Q1 graphite rod at 20 °C . . . . .	18
Figure 10. Electrical resistivity versus density of an AXM-5Q and AXM-9Q1 graphite rod at 76 K (illustrating short range correlation) . . . . .	19
Figure 11. Electrical resistivity versus position along AXF and FXI graphite rods . . . . .	20
Figure 12. Ambient-temperature, comparative thermal conductivity apparatus for small specimens . . . . .	23
Figure 13. Electrical resistivity-thermal conductivity correlation of AXM graphite at 296 K . . . . .	26
Figure 14. Lorenz ratio-density correlation of AXM graphite at 296 K . . . . .	27

	Page
Figure 15. Lorenz ratio-electrical resistivity data of AXM graphite at 296 K . . . . .	28
Figure 16. Lorenz ratio-density data of FXI and AXF compared to AXM graphite values . . . . .	30
Figure 17. Electrical resistivity versus position of 25.4 mm diameter AXM graphite rods . . . . .	34
Figure 18. Electrical resistivity versus position of 25.4 mm diameter AXM graphite rods . . . . .	35
Figure 19. Electrical resistivity versus position of 25.4 mm diameter AXM graphite rods . . . . .	36
Figure 20. Electrical resistivity versus position of 25.4 mm diameter AXM graphite rods . . . . .	37
Figure 21. Electrical resistivity versus position of 25.4 mm diameter AXM graphite rods . . . . .	38
Figure 22. Electrical resistivity versus position of 12.7 mm diameter AXM graphite rods . . . . .	39
Figure 23. Electrical resistivity versus position of 12.7 mm diameter AXM graphite rods . . . . .	40
Figure 24. Electrical resistivity versus position of 12.7 mm diameter AXM graphite rods . . . . .	41
Figure 25. Electrical resistivity versus position of 12.7 mm diameter AXM graphite rods . . . . .	42
Figure 26. Electrical resistivity versus position of 12.7 mm diameter AXM graphite rods . . . . .	43
Figure 27. Electrical resistivity versus position of 12.7 mm diameter AXM graphite rods . . . . .	44
Figure 28. Electrical resistivity versus position of 6.4 mm diameter AXM graphite rods . . . . .	45
Figure 29. Electrical resistivity versus position of 6.4 mm diameter AXM graphite rods . . . . .	46
Figure 30. Electrical resistivity versus position of 6.4 mm diameter AXM graphite rods . . . . .	47
Figure 31. Electrical resistivity versus position of 6.4 mm diameter AXM graphite rods . . . . .	48
Figure 32. Electrical resistivity versus position of 6.4 mm diameter AXM graphite rods . . . . .	49

	Page
Figure 33. Electrical resistivity versus position of 6.4 mm diameter AXM graphite rods . . . . .	50
Figure 34. Thermal conductivity data from Hust (7) on seven AXM-5Q1 graphite specimens at 296 K . . . . .	61
Figure 35. Thermal conductivity data from Hust (7) on seven AXM-5Q1 graphite specimens, six at 296 K and one specimen from 6 to 300 K . . . . .	62
Figure 36. Thermal conductivity data for seven AXM-5Q1 graphite specimens from the following participants at temperatures from 5 to 2600 K . . . . .	63
Figure 37. Thermal conductivity data for four AXM-5Q1 graphite specimens from the following participants at temperatures from 300 to 2600 K . . . . .	64
Figure 38. Thermal conductivity deviations for seven AXM-5Q1 graphite specimens as reported by Hust (7) from eq. (5.1.2) at 296 K . . . . .	66
Figure 39. Thermal conductivity deviations for seven AXM-5Q1 graphite specimens as reported by Hust (7) from eq. (5.1.2), six at 296 K and one at temperatures from 6 to 300 K . . . . .	67
Figure 40. Thermal conductivity deviations for seven AXM-5Q1 graphite specimens as reported by the following participants from eq. (5.1.2) at temperatures from 5 to 2600 K . . . . .	68
Figure 41. Thermal conductivity deviations for four AXM-5Q1 graphite specimens as reported by the following participants from eq. (5.1.2) at temperatures from 300 to 2600 K . . . . .	69
Figure 42. Thermal conductivity deviations of all AXM-5Q1 graphite data from eq. (5.1.2). Composite of Figures 38-41 . . . . .	70
Figure 43. Thermal conductivity deviations of all AXM-5Q1 graphite data from eq. (5.1.2) with $M_1 = 1$ . . . . .	71
Figure 44. Thermal conductivity deviations of all AXM-5Q1 graphite data from eq. (5.1.2) with $M_2 = 1$ . . . . .	72
Figure 45. Electrical resistivity data from Hust (7) on seven AXM-5Q1 graphite specimens at 296 K . . . . .	76
Figure 46. Electrical resistivity data from Hust (7) on seven AXM-5Q1 graphite specimens, six at 296 K and one specimen from 6 to 300 K . . . . .	77
Figure 47. Electrical resistivity data for seven AXM-5Q1 graphite specimens from the following participants from 5 to 2900 K . . . . .	78

	Page
Figure 48. Electrical resistivity deviations for seven AXM-5Q1 graphite specimens as reported by Hust (7) from eq. (5.2.2) at 296 K . . . . .	80
Figure 49. Electrical resistivity deviations for seven AXM-5Q1 graphite specimens as reported by Hust (7) from eq. (5.2.2), six at 296 K and one at temperatures from 6 to 300 K . . . . .	81
Figure 50. Electrical resistivity deviations for six AXM-5Q1 graphite specimens as reported by the following participants from eq. (5.2.2) at temperatures from 5 to 2500 K . . . . .	82
Figure 51. Electrical resistivity deviations of all (excluding participant 2) AXM-5Q1 graphite data from eq. (5.2.2). Composite of Figures 48-50 . . . . .	83
Figure 52. Electrical resistivity deviations of all AXM-5Q1 graphite data from eq. (5.2.2) without the correction for room temperature differences . . . . .	84
Figure 53. Specific heat data for four AXM-5Q1 graphite specimens from the following participants at temperatures from 80 to 2900 K . . . . .	85
Figure 54. Specific heat deviations for four AXM-5Q1 graphite specimens as reported by the following participants from eq. (5.3.1) at temperatures from 80 to 2900 K . . . . .	87
Figure 55. Thermal diffusivity data for seven AXM-5Q1 graphite specimens from the following participants from 280 to 2600 K . . . . .	88
Figure 56. Thermal diffusivity data for four AXM-5Q1 graphite specimens from the following participants from 480 to 2900 K . . . . .	89
Figure 57. Thermal diffusivity deviations for seven AXM-5Q1 graphite specimens as reported by the following participants from eq. (5.4.1) at temperatures from 280 to 2600 K . . . . .	90
Figure 58. Thermal diffusivity deviations for four AXM-5Q1 graphite specimens as from the following participants from eq. (5.4.1) at temperatures from 480 to 2900 K . . . . .	91
Figure 59. Thermal diffusivity deviations for seven AXM-5Q1 graphite specimens as from the following participants from eq. (5.4.1) (without corrections for room temperature differences) at temperatures from 280 to 2600 K . . . . .	92

Figure 60. Thermal diffusivity deviations for four AXM-5Q1 graphite specimens as from the following participants from eq. (5.4.1) (without corrections for room temperature differences) at temperatures from 480 to 2900 K . . . . .	93
Figure 61. Density deviations for three AXM-5Q1 specimens as reported by Taylor (12) from eq. (5.5.1) for temperatures from 300 to 2500 K . . . . .	96
Figure 62. Seebeck coefficient data for three AXM-5Q1 graphite specimens. Two data sets from Hust (7) at temperatures from 5 to 300 K and one set from Moore (11) at temperatures from 80 to 800 K . . . . .	97



A FINE-GRAINED, ISOTROPIC GRAPHITE FOR USE AS NBS THERMOPHYSICAL PROPERTY RM'S  
FROM 5 to 2500 K\*

J. G. Hust  
Chemical Engineering Science Division  
Center for Chemical Engineering  
National Engineering Laboratory  
National Bureau of Standards  
Boulder, Colorado 80303

ABSTRACT

The Chemical Engineering Science Division (Boulder, Colorado) in conjunction with the Office of Standard Reference Materials (Gaithersburg, Maryland) of the National Bureau of Standards, and the CODATA Task Group on Thermal Transport Properties have investigated graphite as a potential, extended temperature range, Research Material (RM). A large number of isotropic, fine-grained graphite rods in various diameters were obtained for these investigations.

In Phase I, electrical resistivity and density measurements were performed on numerous rods at temperatures from 4 to 300 K. In Phase II, thermal conductivity measurements were performed on thirteen specimens at about 20 °C. These measurements show that transport property variations, both between and within these rods, is relatively large (approximately 10%). However, a correlation between these variables is shown to exist which will allow the calculation of thermal conductivity from simple and inexpensive electrical resistivity and density measurements to within about  $\pm 2\%$ . In Phase III, a large number of specimens were characterized for room temperature electrical resistivity and density. These measurements were in preparation for the worldwide distribution of specimens to participants that agreed to make thermal and electrical property measurements. Phase IV describes the results of the measurements from the various participants. Phase V describes the analysis of these data.

---

\*This work was sponsored by the National Bureau of Standards, Office of Standard Reference Materials (NBS-OSRM), Gaithersburg, MD.

Key Words: characterization; density; electrical resistivity; graphite; Lorenz ratio; Research Materials; thermal conductivity.

## 1. INTRODUCTION

Considerable interest has been shown in establishing a fine-grained, isotropic graphite for use as a Research Material (RM) for thermophysical properties. Preliminary work on the Air Force Materials Laboratory-Advisory Group for Aerospace Research and Development, NATO (AFML-AGARD) program showed that graphite is a promising material. It is especially interesting because of its relatively low cost, ease of fabrication, and its wide temperature range.

The AFML-AGARD program (1965 to 1975) resulted in extensive thermophysical property measurements on several materials including graphite. These measurements have been reported in detail by Fitzer [1] and Minges [2]. The graphite portion of that program is summarized below:

### AFML-AGARD PROGRAM (1965-1975)

#### Material

Fine-grained-isotropic graphite	Ave. density = 1.757 g/cm <sup>3</sup>
10 cm dia. x 30 cm long cylinders	Max. variations = $\pm 1.3\%$
5 cm x 10 cm x 15 cm blocks	Heat treated at 2500 °C

#### Measurements

<u>Property</u>	<u>Temp. Range</u>	<u>Variations</u>	<u>No. of Investigators</u>
Thermal Diffusivity	400-2600 K	+7%	9
Thermal Conductivity	300-2500 K	+10%	5
Thermal Expansion	300-2800 K	+3%	10
Heat Capacity	1900-2800 K	---	1
Electrical Resistivity	400-2600 K	+4% at 1300 K	2

It was concluded as a result of the program that this graphite is very promising, but that further work should be performed. The remaining stock of this AFML material was donated to NBS for further study and/or use. The remaining quantity of material, however, was quite limited. Unfortunately, also, the specimens that

were distributed to participants of the program were neither individually characterized prior to measurement, nor were they collected after measurement for post-characterization. Because of this, NBS decided to purchase a supply of the same fine-grained graphite (AXM-5Q1) for further study. To establish a reasonable supply, 400 6.4 mm diameter rods, 150 12.7 mm diameter rods, and 70 25.4 mm diameter rods were purchased. All rods are 30 cm in length. In addition, some AXM-5Q and AXM-9Q material was purchased for research purposes. This material was specified to have a density in the range 1.72-1.75 g/cm<sup>3</sup>.

This fine-grained graphite is produced by molding into blocks or plates. Rods are then cut and machined from the blocks. Petroleum coke is the source of the graphite, and the final graphitization is performed at 2500 °C, or in the case of the 9Q material at 2900 °C. Further preparation details are considered proprietary by the supplier. The supplier indicated that the most homogeneous product will come from relatively thin plates. These rods were machined from 5 cm x 10 cm x 30 cm plates.

## 2. PHASE I - PRELIMINARY ELECTRICAL RESISTIVITY AND DENSITY CHARACTERIZATION

### 2.1 Specimen Preparation

To perform electrical resistivity and density measurements, specimens of 6.4 mm diameter and 50 mm length were required. Rods were randomly selected from the 6.4 mm diameter rods and notched with a code indicating the pack and rod from which they came. The code is a three digit number corresponding to the number of notches on each end and on the side near end 1, i.e., 1st digit = notches on end no. 1, 2nd digit = notches on end no. 2, 3rd digit = notches on side no. 1. Rods 50 mm in length were cut from the 25.4 mm diameter rods. These were quartered and machined to 6.4 mm diameter rods. Also some scrap blocks from the AFML-AGARD material were machined to 6.4 mm diameter specimens for intercomparison with the new rod material. A total of 39 specimens were prepared: 21 from

the 6.4 mm diameter rods, 12 from three 25.4 mm diameter rods, and six from a single slab of AFML material.

## 2.2 Measurements

All electrical resistivity measurements were performed with four-terminal D.C. potentiometric apparatus. The imprecision of this apparatus is estimated at  $\pm 0.5\%$ . (For inhomogeneity determinations the imprecision, not the uncertainty, is paramount). Electrical resistivities were determined at 4 K, 76 K, and 273 K on most of the specimens. Some of the specimens were measured only at 76 K.

Densities were first calculated from air weight-volume measurements. This was done because it was suggested that the usual hydrostatic weighing technique could not be used on graphite. This seemed reasonable because it was assumed that the graphite would absorb water and give incorrect bulk densities. After the initial tests, hydrostatic weighings to check the previous statement were performed. Surprisingly, the hydrostatic weighing method yielded results entirely consistent with the air weight-volume method. No water absorption was observed during the measurements. The densities reported here are, therefore, based on the hydrostatic weighing method which is considered to yield more precise results. All density measurements were performed at ambient temperature, approximately 20 °C. These measurements are estimated precise to  $\pm 0.1\%$ .

After the NBS-Boulder electrical resistivity and density measurements, recorded in Table 1, a group of seventeen specimens was selected from the 39 specimens. These were sent to Mr. Pears of Southern Research Institute (SoRI) for annealing at 3180 °C (5750 °F). Mr. Pears suggested that the variability in density and electrical resistivity could be considerably reduced after such an anneal. The electrical resistivities and densities were measured at 20 °C both prior to and after the 3180 °C anneal at SoRI. These results are also listed in Table 1. It is noted that the densities of NBS and SoRI agree quite well and the



Table 1. Resistivity and Density Data for AXM-5Q1 Graphite Specimens.

Specimen Identification	$\rho_4$ $\mu\Omega\cdot m$	$\rho_{76}$ $\mu\Omega\cdot m$	$\rho_{273}$ $\mu\Omega\cdot m$	Density* NBS <sub>3</sub> g/cm <sup>3</sup>	Density SoRI (Pre)	$\rho_{293}$ SoRI (Pre)	Density SoRI (Post)	$\rho_{293}$ SoRI (Post)
100	29.42	24.02	15.23	1.755				
200 AFML Scrap	29.28	23.92	15.27	1.751				
300 blocks	29.91	24.47	15.67	1.742	1.741	14.59	1.747	11.58
400 (6.4 mm dia)	29.35	23.91	15.21	1.754	1.752	14.56	1.746	11.46
500	29.15	23.67	15.08	1.754				
600	28.50	23.27	14.85	1.765	1.757	14.03	1.757	11.16
101 Rod	28.59	23.28	14.81	1.721	1.720	13.96	1.717	12.74
201 No. 1	29.51	24.10	15.32	1.706				
301	28.93	23.57	15.07	1.713	1.713	14.32	1.709	12.74
401	29.60	24.12	15.29	1.707	1.705	14.85	1.703	13.19
102	26.52	21.24	13.12	1.751				
202 Rod AXM-5Q1	26.87	21.52	13.27	1.749				
302 No. 2 POCO	27.06	21.69	13.49	1.746				
402 No. 2 25.4 mm to 6.4 mm dia	26.65	21.34	13.25	1.752				
103	29.63	24.20	15.49	1.721				
203	28.90	23.58	14.99	1.735				
303	28.90	23.55	15.00	1.734				
403	29.45	24.04	15.34	1.722				
110 Rod end a	28.23	23.04	14.74	1.732				
210 No. 1 b	26.46	21.47	13.53	1.782	1.783	12.95	1.781	12.20
310 Rod No. 2 AXM-5Q1	33.80	28.12	18.56	1.698				
111 Pack 1A		22.30		1.768				
121 Rod		23.35		1.750	1.744	14.30	1.748	13.48
131 No. 1		24.69		1.721	1.722	15.30	1.720	14.27
141		23.94		1.732				
151 Rod No. 1	31.94	26.06	16.61	1.727	1.732	15.80	1.730	13.12
211 Rod No. 2 Pack	29.77	24.12	15.20	1.709				
311 Rod end a 2A	32.28	26.66	17.27	1.709	1.713	16.42	1.711	13.98
411 No. 3 b	28.22	23.02	14.67	1.775	1.778	14.09	1.775	12.19
152 Rod end a	32.00	26.14	16.68	1.697	1.700	16.18	1.697	13.28
212 No. 1 b	29.41	23.78	14.99	1.716				
312 Rod No. 2	30.55	25.13	16.26	1.747				
412 Rod No. 3 Pack	31.40	25.95	16.80	1.725	1.723	16.12	1.720	14.15
112 3A		25.22		1.706				
122 Rod		24.65		1.717	1.719	14.86	1.717	12.76
132 No. 1		24.17		1.724				
142		23.91		1.728	1.727	14.34	1.725	12.50
113 Rod No. 1 Pack 4A	29.34	23.99	15.38	1.727				
104 Rod No. 1 Pack 5A	31.38	26.22	17.31	1.751	1.753	16.49	1.748	12.94

\*All NBS densities measured near 20 °C.

effect of the high temperature anneal is small on density. However, the electrical resistivities were affected considerably by the anneal.

### 2.3 Results and Discussion

To determine the consistency of the NBS measurements and the SoRI measurements, graphs were made of the resistivity as a function of temperature. These plots, Figures 1, 2, and 3 illustrate several important points. First they confirm a measurement imprecision of near  $\pm 0.5\%$ . (They also indicate a comparable accuracy). These plots also indicate that the differences between specimens are temperature independent to within the measurement imprecision from 4 to 300 K. Since the SoRI measurements were performed at 293 K and the NBS measurements were done at 4, 76, and 273 K, direct intercomparison is not possible. However, these plots show excellent correspondence between the two sets of data.

The second set of plots, Figures 4, 5, and 6 illustrate the dependence of electrical resistivity on density at 4, 76, and 273 K, respectively. The lines drawn on these figures show the resistivity-density correlation for groups of specimens coming from single rods or plates. As can be seen, very strong correlation (intra-rod correlation) exists for such groups. It is also clear that the electrical resistivity-density correlation between such groups (inter-rod correlation) is very weak. Obviously electrical resistivity is strongly dependent on density but also on a density independent parameter which varies from rod-to-rod but is fairly constant within each rod. This may be related to the chemical purity, the degree of graphitization, or the void (vacancy) concentration and distribution of each rod. At this time, the source of these inter-rod differences are not clear. The intra-rod correlation corresponds to a four percent change in electrical resistivity per one percent change in density at all temperatures.

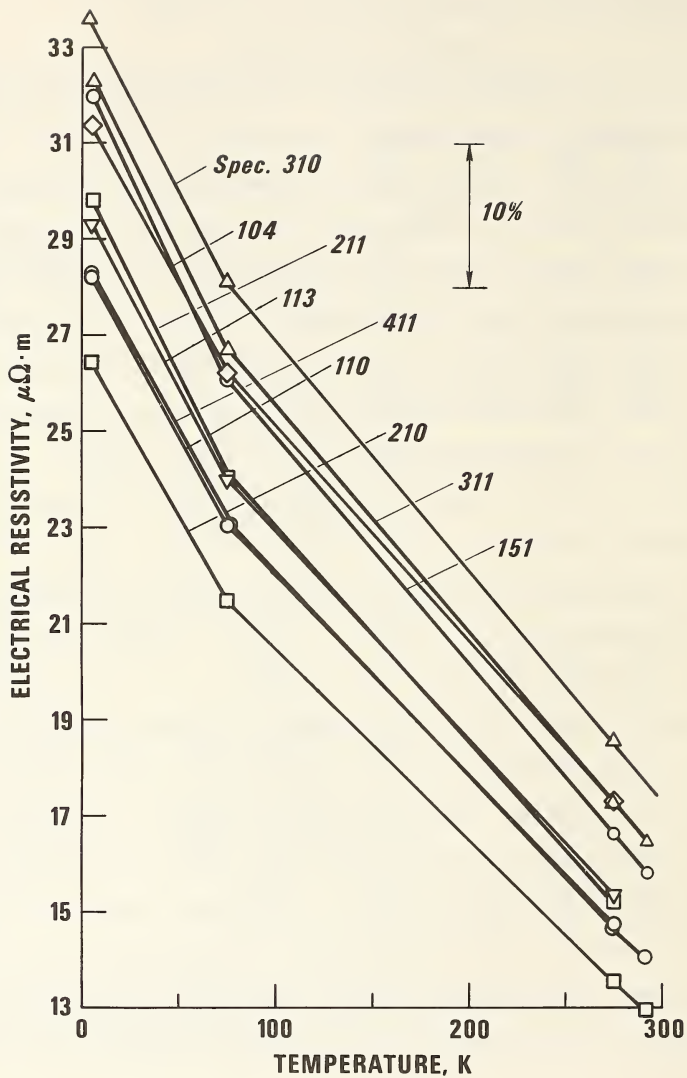

Figure 1. Electrical resistivity as a function of temperature of nine AXM graphite specimens.

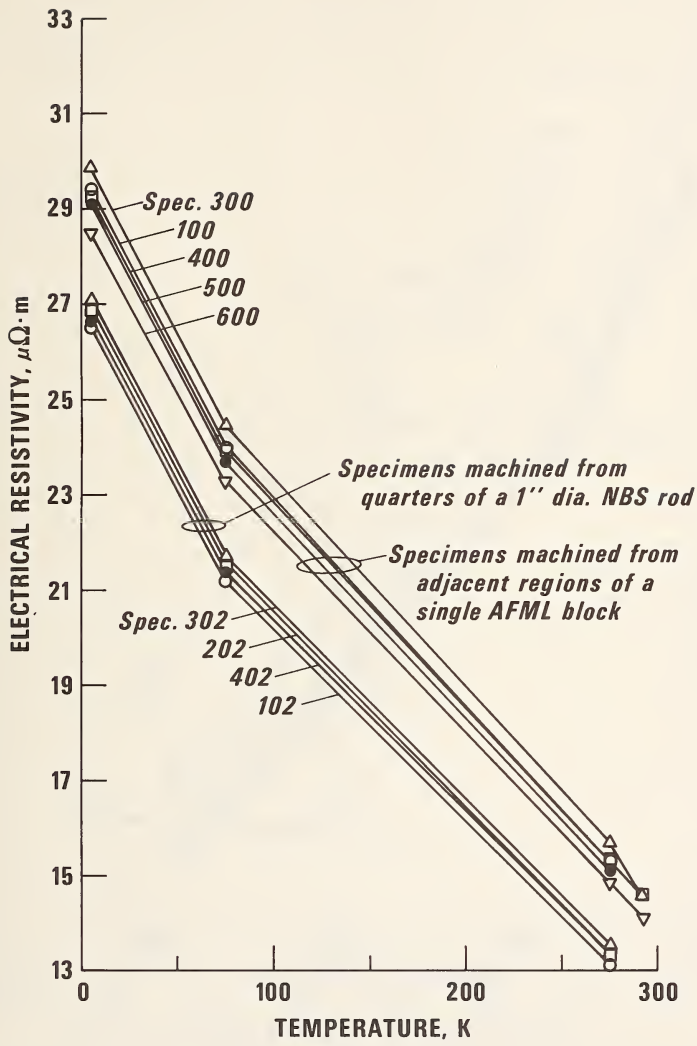

Figure 2. Electrical resistivity as a function of temperature of ten AXM graphite specimens. Four specimens taken from a single 25.4 mm diameter NBS rod and six specimens taken from a single AFML slab to illustrate short range inhomogeneity.

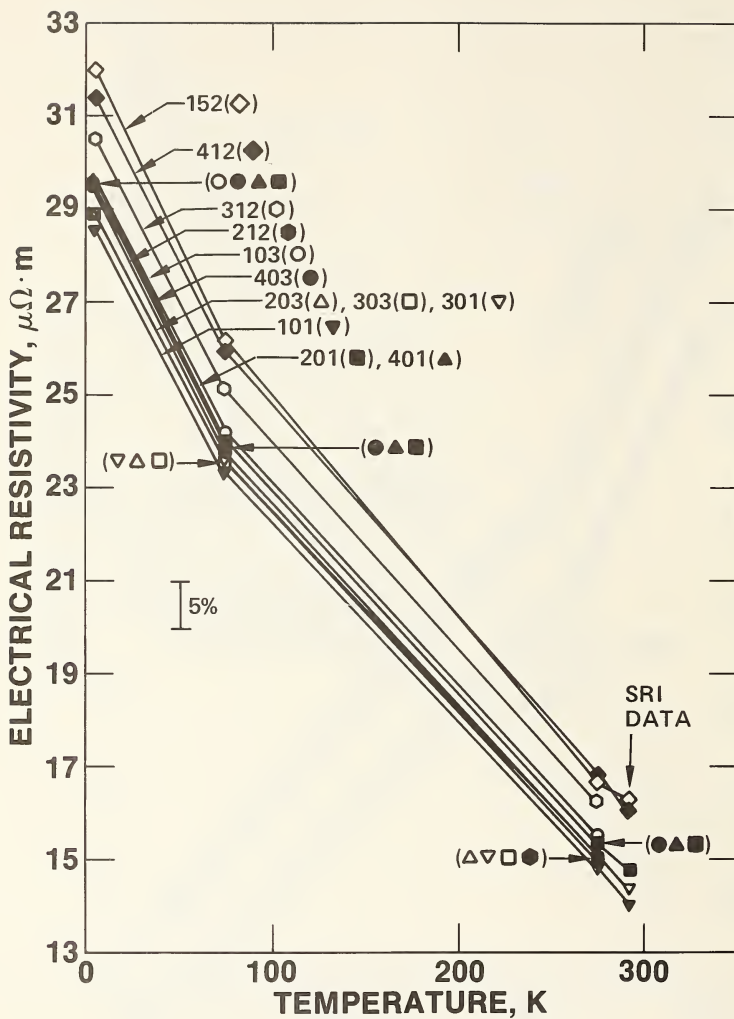

Figure 3. Electrical resistivity as a function of temperature of twelve AXM graphite specimens.



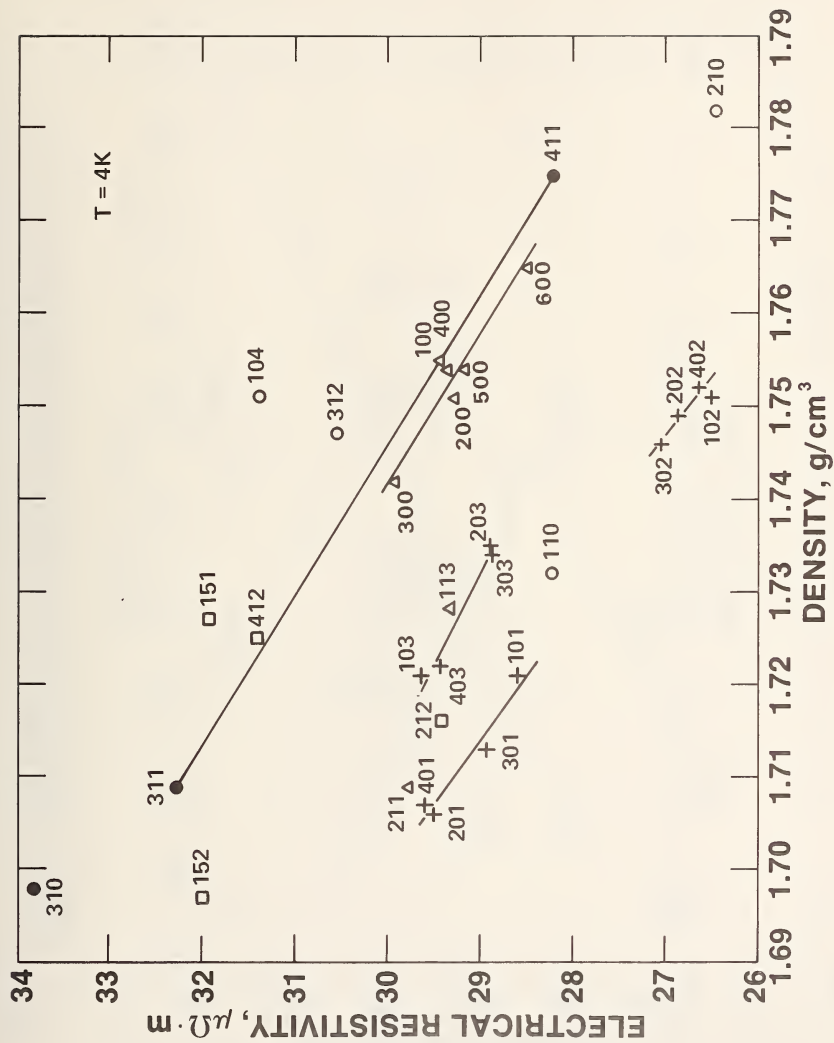

Figure 4. Electrical resistivity versus density of AXM graphite specimens at 4 K (solid lines indicate intra-rod correlation).

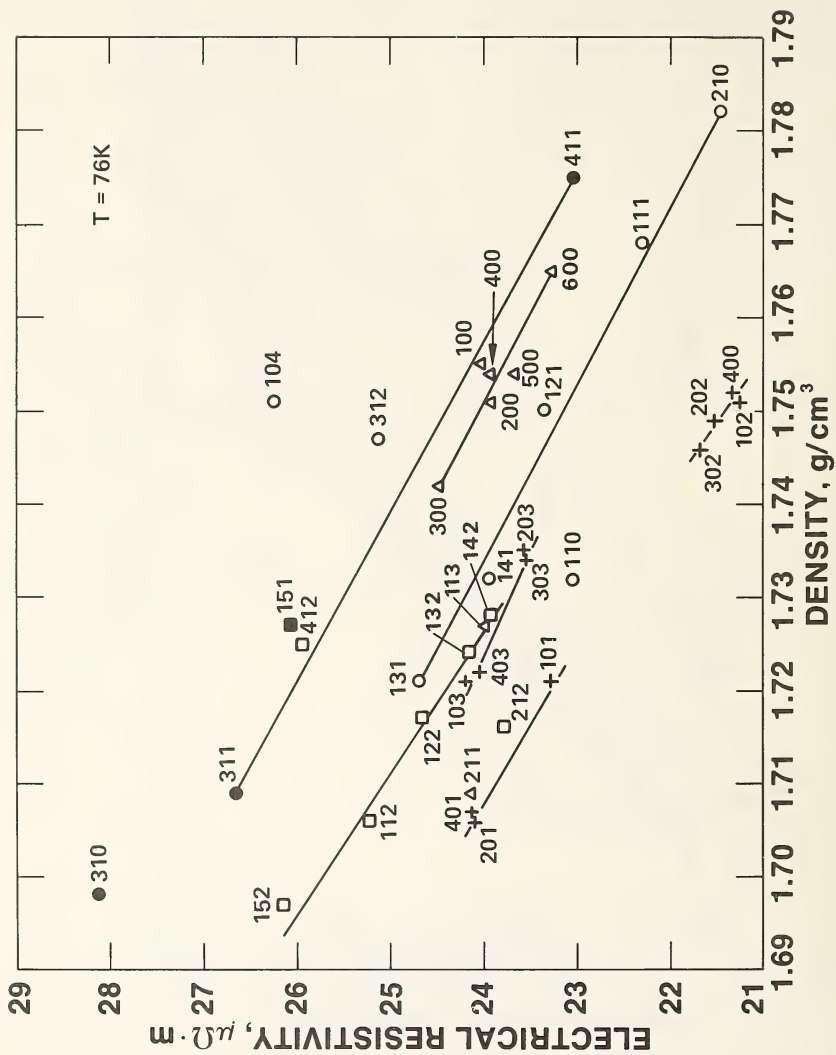

Figure 5. Electrical resistivity versus density of AXM graphite specimens at 76 K (solid lines indicate intra-rod correlation).

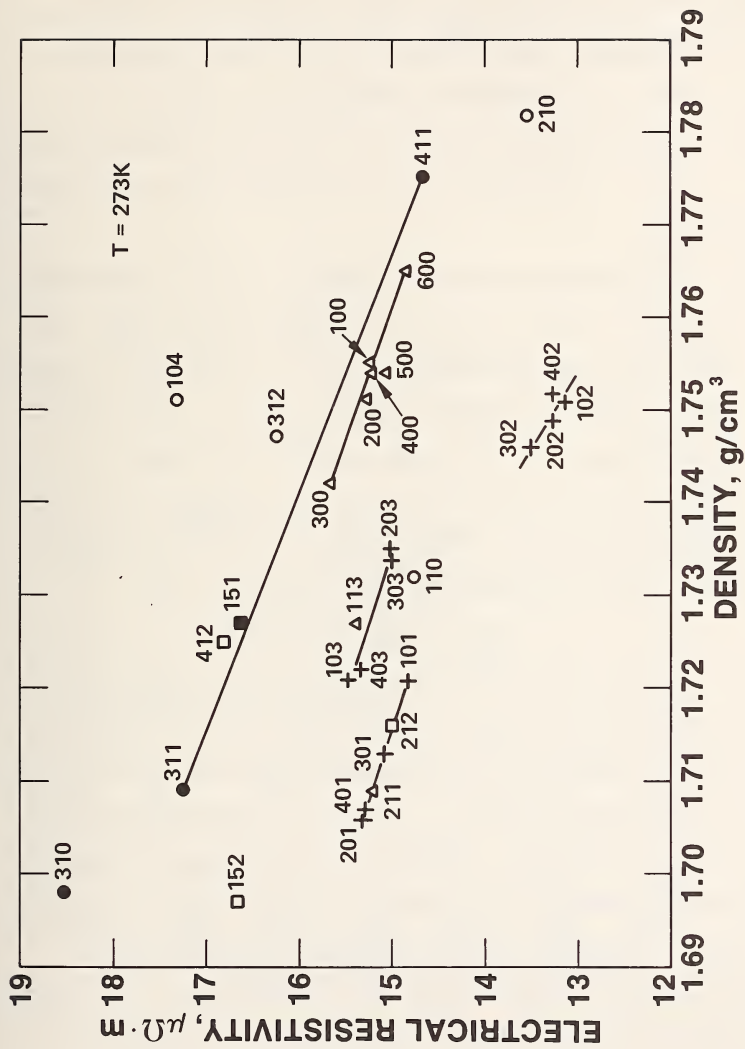

Figure 6. Electrical resistivity versus density of AXM graphite specimens at 273 K (solid lines indicate intra-rod correlation).

Figure 7 illustrates the resistivity-density data taken at SoRI. The arrows between pairs of data points are directed from the preanneal to the post-anneal data. The average change in density was about 0.2%, and the average change in resistivity about 15%. No significant improvement in homogeneity is observed as a result of the 3180 °C anneal. The intra-rod electrical resistivity-density correlation also remained the same after the high temperature anneal. It is clear that a high temperature anneal is necessary to stabilize the specimens for use above 2500 °C; but, it is also clear that such an anneal does not appreciably improve the homogeneity.

In addition to the above described results on AXM-5Q1, several measurements were performed on one rod of AXM-9Q1 and one rod of AXM-5Q. Each of these rods were cut into six specimens. The densities and electrical resistivities of these specimens are listed in Table 2 and plotted in Figures 8 and 9. These figures show a uniform change in property from one end of the rod to the other. Figure 10 shows the electrical resistivity versus density correlation for these two rods. Again a strong correlation is observed and the value of the slope is in agreement with the results from the AXM-5Q1 measurements.

#### 2.4 Other Graphites

Three rods of AXF-5Q material and two rods of spectroscopic purity graphite, designated as FXI material, were obtained for measurement. The FXI material is higher purity and density than the AXF and AXM material. The average density of each of the five rods and the resistivity as a function of position along these rods at 2.5 cm intervals was measured. These data are illustrated in Figure 11. The results show that the intra-rod variability in electrical resistivity for the AXF material is about 13%, and the inter-rod variability is about the same. These results are comparable to those obtained with the AXM material. The results on the spectroscopic purity rods show the rate of change in resistivity as a

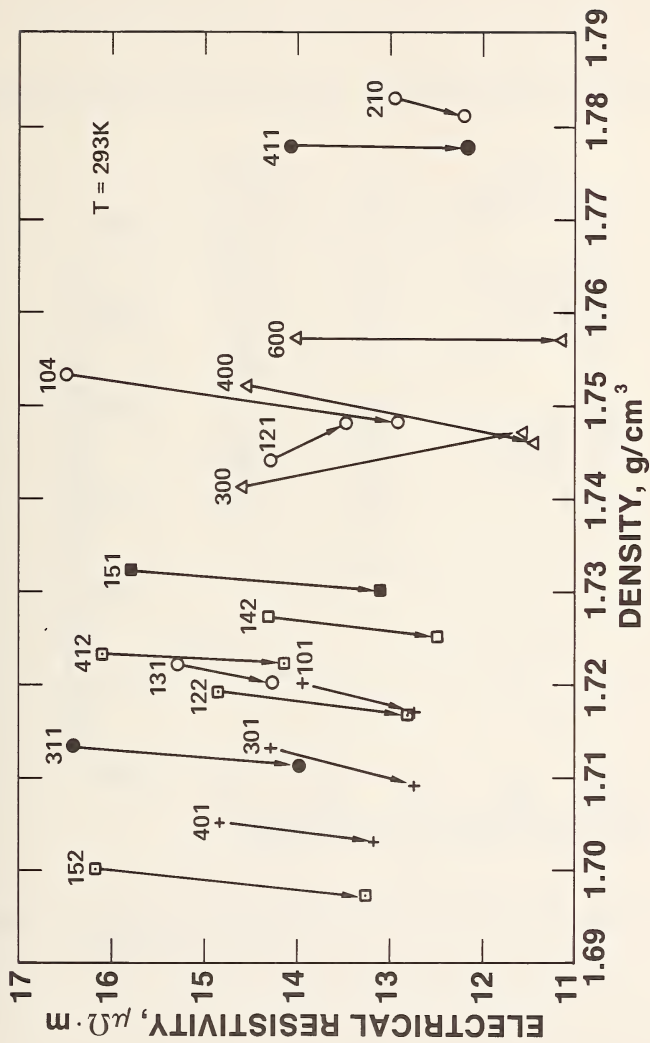

Figure 7. Electrical resistivity versus density of AXM graphite specimens at 293 K. Data obtained at SoRI prior to and after anneal at 3180°C for one hour. Arrows point to post-anneal data.

Table 2. Resistivity and Density Data for AXM-5Q and 9Q1 Graphite Specimens.

Specimen Identification	$\rho_{76K}$ $\mu\Omega \cdot m$	Density $g \cdot cm^{-3}$
410	19.64	1.724
510	19.18	1.734
610	18.93	1.736
220	18.95	1.737
320	18.71	1.742
420	19.15	1.731
520	21.32	1.739
620	21.55	1.733
330	22.01	1.721
430	22.49	1.716
530	23.01	1.708
630	23.15	1.696



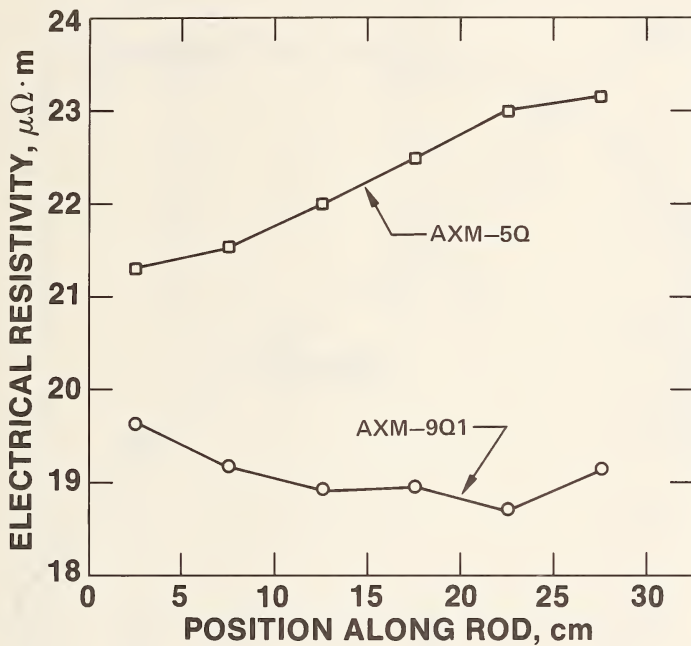

Figure 8. Electrical resistivity versus position along an AXM-5Q and AXM-9Q1 graphite rod at 76 K.

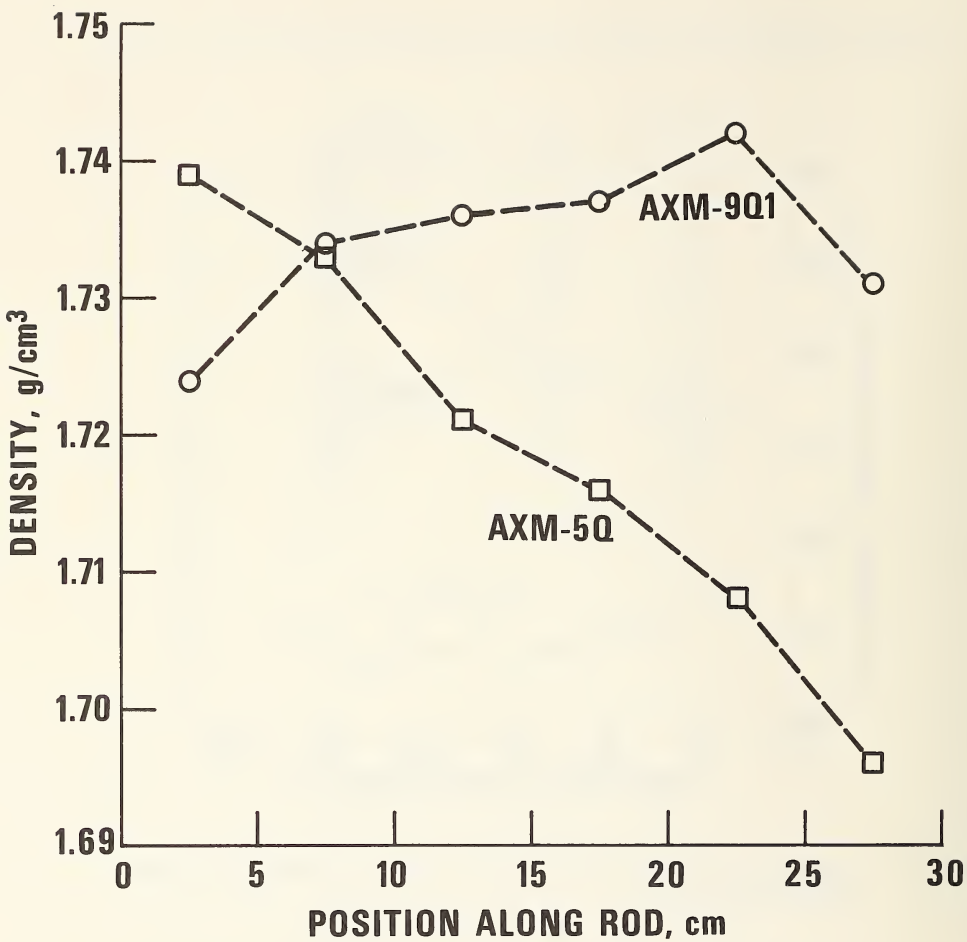

Figure 9. Density versus position along an AXM-5Q and AXM-9Q1 graphite rod at 20°C.

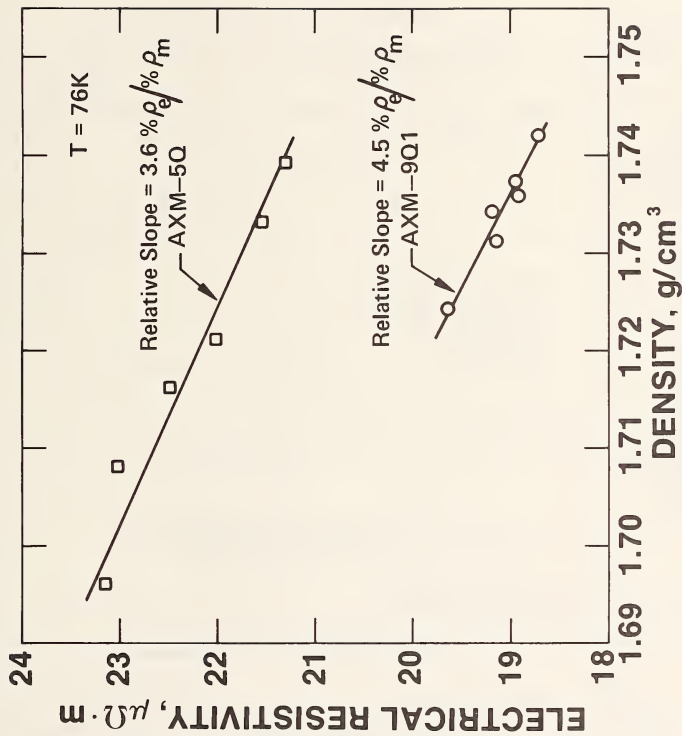

Figure 10. Electrical resistivity versus density of an AXM-5Q and AXM-9Q1 graphite rod at 76 K (illustrating short range correlation).

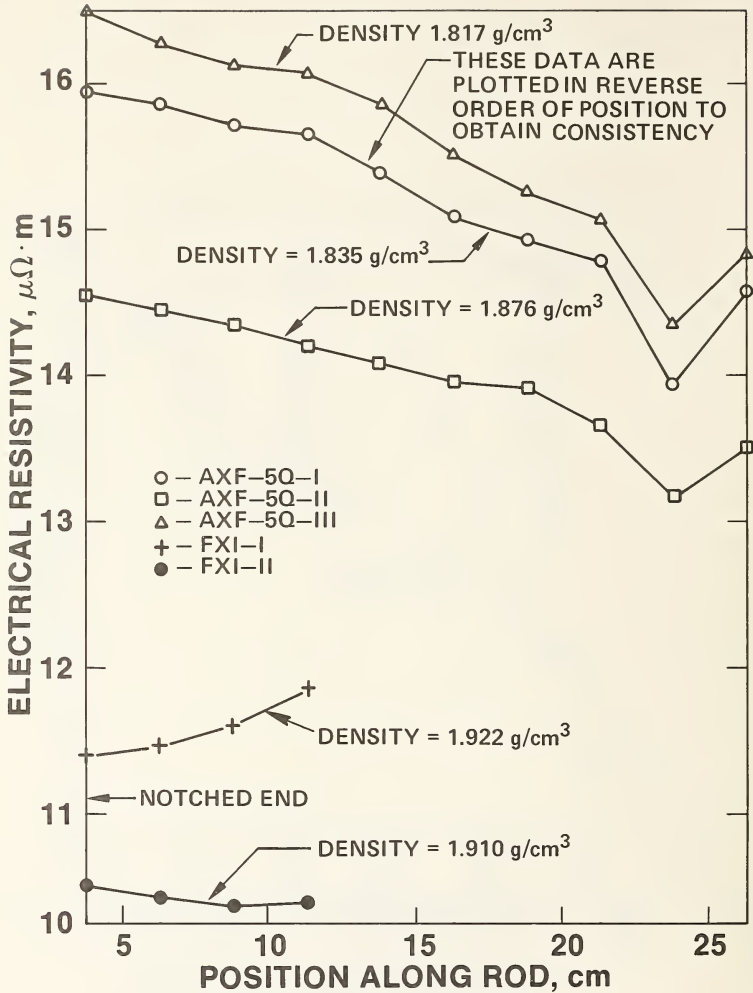

Figure 11. Electrical resistivity versus position along AXF and FXI graphite rods.

function of position (i.e., slope of  $\rho$  vs  $X$ ) is of comparable magnitude. However, these rods were only 15 cm long compared to 30 cm for the AXF material, and therefore the total change was not as great for the FXI material. The difference between the two FXI rods is near 10% in resistivity. Thus it appears that neither of these materials is better than the AXM material from a homogeneity standpoint.

## 2.5 Conclusions and Recommendations

The inhomogeneity in electrical resistivity of these graphite rods is discouragingly high. It is clear that this lot of graphite cannot be used as an electrical resistivity SRM without characterizing each rod. If the thermal conductivity correlates with electrical resistivity, as expected, the same statements are applicable to thermal conductivity. Thermal expansion and specific heat are not expected to be sensitive to these inhomogeneities and, therefore, this lot of graphite may be acceptable for these properties.

Because of the merits of using graphite for various RM's, it was recommended that further work be done on this lot of graphite to investigate the thermal conductivity-electrical resistivity-density correlations. This work represents Phase II of this investigation.

## 2.6 Summary of Phase I

1. The inhomogeneity in electrical resistivity (and of thermal conductivity by association) of this lot of graphite rods is excessively high for use as SRM's, unless each piece is certified.

2. A strong intra-rod correlation exists between electrical resistivity and density. This correlation is practically non-existent over this range of densities for inter-rod specimens.

3. Annealing the specimens at 3180 °C produces an average decrease of 16% in electrical resistivity and 0.2% in density, but statements (1) and (2) above are still applicable to essentially the same degree for the annealed specimens.

4. The electrical resistivity-density correlation is essentially the same for AXM-5Q1, AXM-5Q, and AXM-9Q graphite.

5. The validity of the above statements is independent of temperature (from 4 to 300 K). Therefore, subsequent homogeneity characterization measurements are conducted at ambient temperature.

6. Further work is recommended to investigate the thermal conductivity-electrical resistivity-density correlation and the feasibility of characterizing each specimen of graphite for SRM use.

### 3. PHASE II. PRELIMINARY THERMAL CONDUCTIVITY CHARACTERIZATION

#### 3.1 Measurements

A series of ambient temperature thermal conductivity measurements with comparative apparatus was completed. This comparative apparatus is schematically illustrated in Figure 12. Prior to the measurements on graphite, a series of runs on two specimens of electrolytic iron (SRM-1463) was conducted to ascertain the accuracy and precision of this apparatus. These measurements showed that the thermal conductivity results are precise to within +1% with no measurable systematic bias.

The thermal conductivity of thirteen graphite specimens was measured covering the entire range of electrical resistivity and density of the previously characterized specimens. Replicate runs were performed to further study the imprecision of the comparative apparatus. These measurements confirm our estimate of imprecision with this comparative apparatus to be +1% for thermal conductivity. The measured results on the thirteen graphite specimens are listed in Table 3.



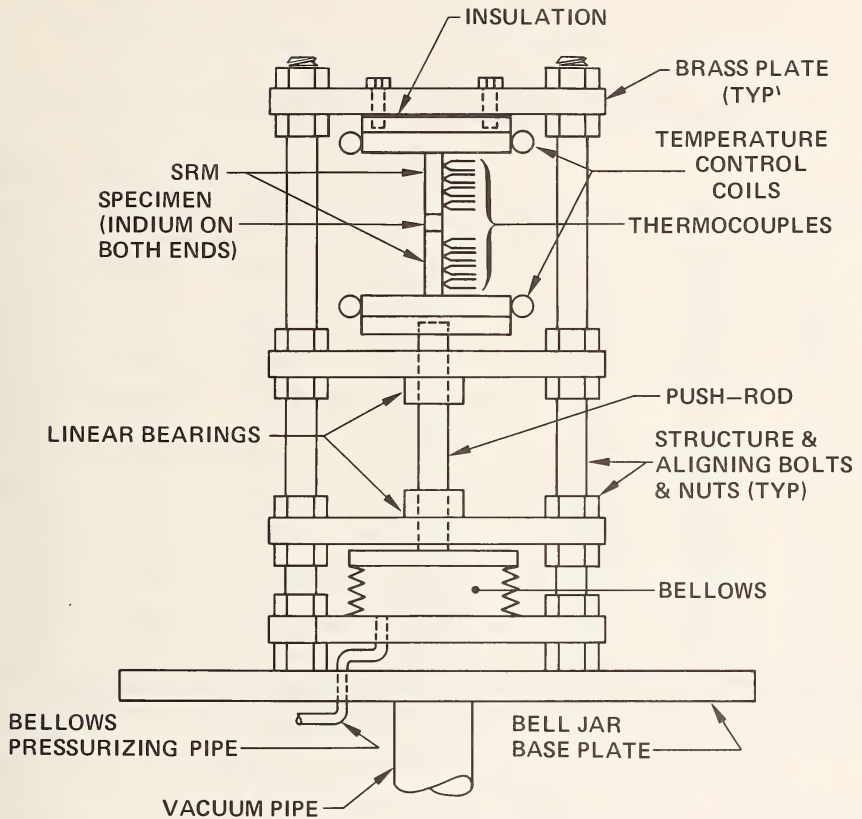

Figure 12. Ambient-temperature, comparative thermal conductivity apparatus for small specimens.

Table 3. Thermal Conductivity, Electrical Resistivity, Density, and Lorenz Ratio for Thirteen AXM Graphite Specimens.

Specimen Identification	T (k)	$\lambda$ ( $W \cdot m^{-1} \cdot K^{-1}$ )	Electrical <sup>a</sup> Resistivity ( $\mu\Omega \cdot m$ )	Density <sup>b</sup> ( $g \cdot cm^{-3}$ )		Lorenz Ratio ( $10^{-8} \nu^2 \cdot K^{-2}$ )
				6.4 mm spec	5 cm spec	
310-0	296.0	72.8	17.5	1.693	1.698	430
"	296.2	72.2	17.5	"	"	426
"	296.7	73.2	17.5	"	"	432
310-1	296.8	73.0	17.5	1.689	"	430
310-2	296.7	73.7	17.5	1.690	"	435
310-3	296.9	73.8	17.5	1.698	"	435
310-4	296.4	74.4	17.5	1.702	"	439
520	295.6	106.4	12.9	1.731	1.739	464
"	295.8	104.9	12.9	"	"	457
"	296.7	105.7	12.9	"	"	460
400	296.3	121.9	11.3	1.755	1.746	465
"	296.4	121.1	11.3	"	"	462
410	296.2	120.0	11.6	1.736	1.724	470
"	296.6	118.0	11.6	"	"	461
102	296.4	112.6	12.6	1.755	1.751	479
"	296.8	112.8	12.6	"	"	479
401	296.2	102.5	13.0	1.716	1.703	450
"	296.4	102.7	13.0	"	"	450
100	297.0	97.0	14.4	1.755	1.755	470
311	296.5	95.1	13.9	1.722	1.711	446
312	296.9	92.5	15.3	1.757	1.747	476

<sup>a</sup>These measurements were performed on 50 mm long specimens from which the 7 mm specimens were obtained.

<sup>b</sup>These densities are for T = 293 K and not for the listed temperature.

The thermal conductivities have a mean of  $96.5 \text{ W}\cdot\text{m}^{-1} \text{ K}^{-1}$  with a range of 72 to 122 or about  $\pm 25\%$ . The electrical resistivities have a mean value of  $15.0 \text{ }\mu\Omega\cdot\text{m}$ , and range from 11.3 to 17.5 or about  $\pm 20\%$ . The mean of the Lorenz ratios,  $\rho\lambda/T$ , is  $453 \times 10^{-8} \text{ V}^2 \text{ K}^{-2}$  with a range from 426 to 479 or about  $\pm 6\%$ . Figure 13 is a plot of electrical resistivity versus thermal conductivity and clearly illustrates their interdependence.

### 3.2 Correlations

In Phase I, a strong intra-rod correlation of electrical resistivity and density, but hardly any inter-rod correlation, was reported. The above results suggest the same would be true of thermal conductivity and density. A plot was made of these variables which shows this to be the case. The possibility of a Lorenz ratio dependence on electrical resistivity or density was investigated. Figures 14 and 15 are plots of Lorenz ratio versus these variables.

Figure 14 indicates that Lorenz ratio at ambient temperature is a linear function of density. The equation for this relationship is  $L = -582 + 600\cdot d$ , with  $d$  in  $\text{g}/\text{cm}^3$ . The total range of deviations in  $L$  from this line is  $\pm 2\%$ . This is within the combined experimental error of determining  $L$  and  $d$ . Thus, for these specimens it would be possible to predict thermal conductivity to better than 2% at ambient temperature from measurements of electrical resistivity and density. The densities used here are based on simple volumetric and weight measurements on the 6.4 mm diameter specimens. The agreement of the data with the line in Figure 14 is consistent with the combined imprecision and uncertainty of the various measurements. The imprecision in the measurement of  $\lambda$  is estimated to be  $\pm 1\%$ , and the imprecision in the measurement of  $\rho$  is estimated to be about  $\pm 0.5\%$ . Thus the imprecision in  $L$  is about  $\pm 1.5\%$ , since the imprecision in measuring  $T$  is negligible. Note that the uncertainty in determining  $\lambda$  and  $\rho$ , caused

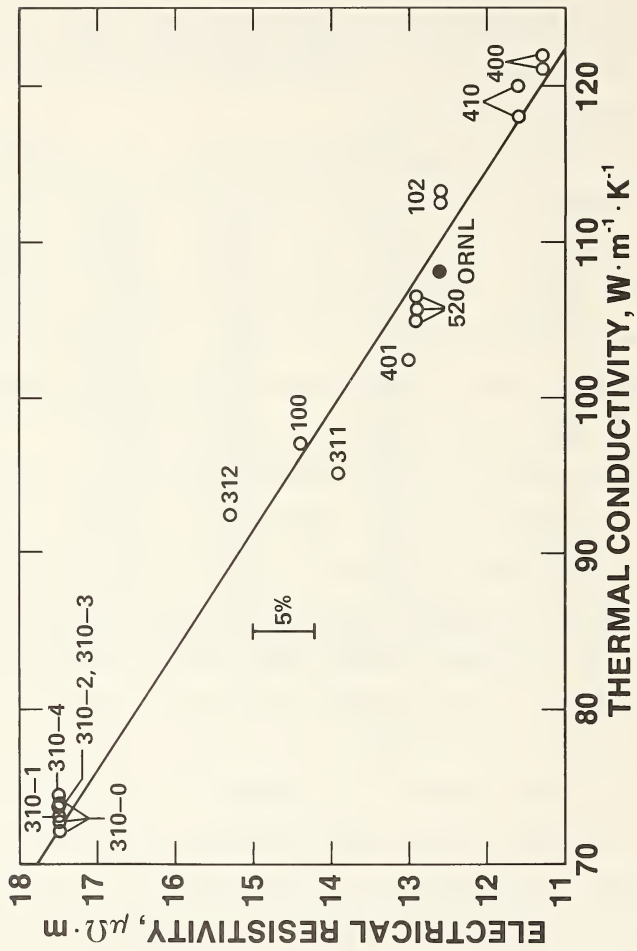

Figure 13. Electrical resistivity-thermal conductivity correlation of AXM graphite at 296 K.

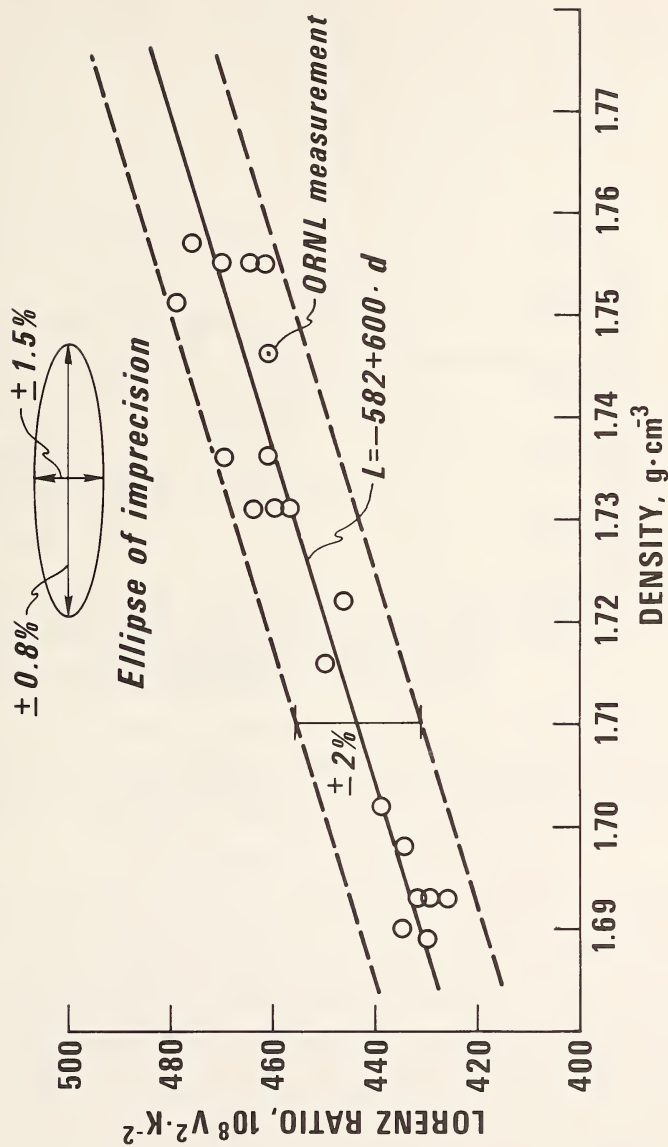

Figure 14. Lorentz ratio-density correlation of AXM graphite at 296 K.

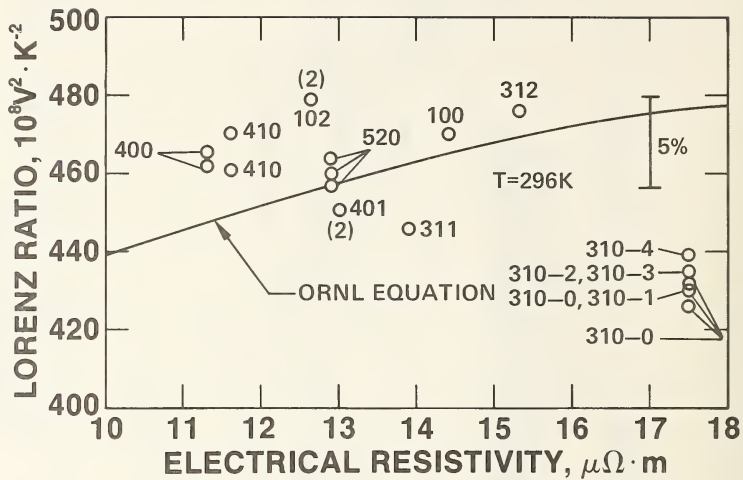

Figure 15. Lorenz ratio-electrical resistivity data of AXM graphite at 296 K.



by the form factor determinations, cancels in the calculation of L. The uncertainty in measuring density on these specimens is estimated to be about  $\pm 0.8\%$ . The corresponding ellipse of imprecision and error band are shown in Figure 14, and it is noted that none of the data points lie outside the estimated error band. A preliminary result of a single measurement performed at ORNL (Peyton Moore, Private Communication) is included in Figure 14, and is in excellent agreement with the NBS measurements.

The scatter of the data points in Figure 15 is large enough that one cannot be sure of any Lorenz ratio dependence on electrical resistivity. In an ORNL report by McElroy, et al. [3] an equation is given describing the observed relationship between thermal and electrical conductivities for a group of graphite specimens with resistivities ranging from 5 to 100  $\mu\Omega\cdot m$ . This equation reduces to  $L = (1.56 \times 10^{-3} - 2.66 \times 10^{-9}/\rho)/T$  and is shown on Figure 15. The agreement of this line with the average of our data for resistivities from 11 to 18  $\mu\Omega\cdot m$  is good, but the trend with respect to  $\rho$  is inconsistent with our data. However, McElroy indicated that their equation described their data to within  $\pm 8\%$  and our data fall within that range.

The Lorenz ratio-density behavior of the AXF and FXI materials was also investigated. Lorenz ratio results for these five specimens deviate by as much as 16% from the line obtained for the AXM material, as shown in Figure 16.

### 3.3 Conclusions and Recommendations

The work described in Phase II shows that it is possible to characterize this lot of graphite, including AXM-5Q1 as received, AXM-5Q1 after anneal at 3180 °C, AXM-5Q and AXM-9Q1, to obtain ambient temperature thermal conductivity values accurate to better than  $\pm 2\%$  using simple electrical resistivity and density measurements on each specimen. It is now believed that graphite material

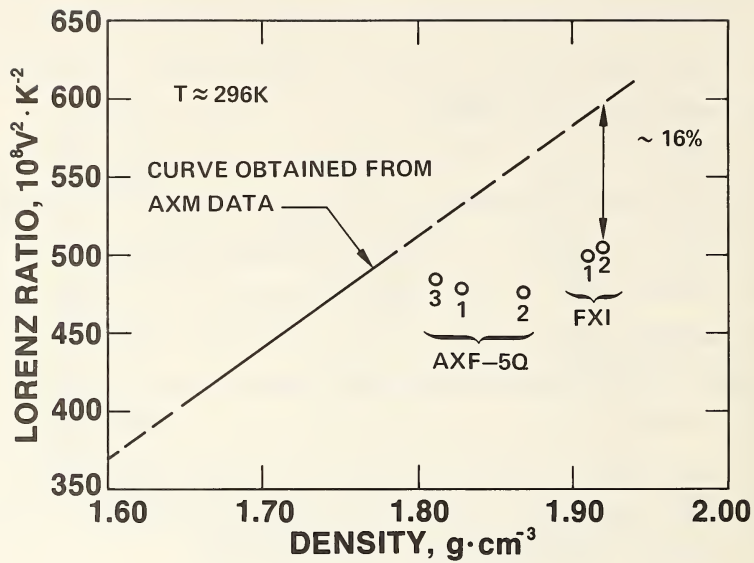

Figure 16. Lorenz ratio-density data of FXI and AXF compared to AXM graphite values.

which is sufficiently homogeneous in transport properties to avoid individual specimen characterization is not available. The inhomogeneities can be reduced through a selection process, but this will necessitate the type of characterization described above.

Further evidence that our inhomogeneity results based on electrical resistivity measurements are not atypical is found in a report by Wilkes [4]. This report is the result of an investigation on the effects of radiation on the transport properties of graphite materials. As part of this research, the electrical resistivity changes along the lengths of numerous rods were determined. Changes on the order of 1%/cm were not uncommon. Such changes are comparable to those observed on the rods reported here.

Although the correlation between  $L$  and  $d$  reported here for ambient temperature is highly encouraging; considerable research still needs to be performed before we can be certain that the correlation applies to the entire temperature range.

#### 4. PHASE III - COOPERATIVE MEASUREMENTS

In view of the encouraging result found in Phase I and II, that thermal conductivity could be accurately predicted at room temperature from simple electrical resistivity and density measurements, the decision was made to proceed with wide-scale cooperative measurements at temperatures from 4 to 3000 K. This phase of the program was conducted in cooperation with the CODATA Task Group on Thermophysical Properties. Dr. M. Minges of the Air Force Materials Laboratory, Dayton, Ohio was instrumental in organizing this phase. For an overall description of this effort, including other SRM's, see reference 5.

##### 4.1 Specimen Characterization

In preparation for the specimen distribution, a large number of rods were characterized for electrical resistivity and density. This step was completed

with the measurement of 50 rods of each available diameter (6.4, 12.7, and 25.4 mm). The average densities of these rods are presented in Table 4. These rods were notched and assigned numbers as follows: The "one's" digit was notched in the side of end 1, the "ten's" digit was notched on end 1, and the "hundred's" digit was notched on end 2. The one's digit was never "zero", so end 1 is always uniquely defined. The 1500 measured electrical resistivities as a function of position along these specimens are plotted in Figures 17 through 33. Since the variation of resistivity along each rod was of primary interest, no attempt was made to measure all of these rods at exactly the same temperature. The measurements were conducted in a thermally lagged box which slowly varied in temperature with room conditions. The box temperature for each set of measurements is indicated in parentheses on Figures 17 through 33. The temperature in the box, during the measurement of each specimen, remained constant to within 0.05 °C. The most homogeneous of these specimens will be used for transport property SRM's. Corrections to a fixed temperature (say 20 °C) can be made by using the slope indicated in Figures 1, 2, and 3,  $0.034 \mu\Omega \cdot m/K$ . In all cases, the correction to 20 °C is less than 1%.

#### 4.2 Specimen Distribution and Results

Dr. Minges (AFML) arranged the participation of 18 experimentalists from around the world. Specimens were prepared to the desired approximate sizes and distributed to these participants. When possible, further electrical resistivity and density characterization measurements were performed at NBS on the actual specimens distributed. In some cases, adjacent pieces were characterized. Nearly all of the participants that were able to report results also published their results in the open literature and are listed in the references. Up to the present time, some reported their results only to the committee, and these will be referred to as participant 1, 2, etc., to maintain confidentiality. A summary of the reported results and pre-characterization data is given in Table 5.

Table 4. Densities of 30 cm long AXM-501 graphite rods at 20°C.

Specimen Identification	Density, g/cm <sup>3</sup>		
	6.4 mm dia	12.7 mm dia	25.4 mm dia
001	1.695	1.718	1.696
002	1.729	1.715	1.728
003	1.733	1.731	1.727
004	1.733	1.722	1.728
005	1.753	1.726	1.720
006	1.736	1.718	1.709
011	1.732	1.728	1.704
012	1.737	1.725	1.706
013	1.734	1.753	1.728
014	1.734	1.737	1.718
015	1.736	1.737	1.709
016	1.746	1.717	1.710
021	1.734	1.735	1.722
022	1.731	1.743	1.741
023	1.734	1.718	1.732
024	1.742	1.741	1.736
025	1.739	1.769	1.709
026	1.744	1.742	1.732
031	1.725	1.738	1.728
032	1.722	1.728	1.716
033	1.747	1.742	1.706
034	1.728	1.745	1.731
035	1.730	1.737	1.722
036	1.739	1.732	1.710
041	1.717	1.720	1.717
042	1.750	1.743	1.711
043	1.739	1.712	1.706
044	1.741	1.744	1.728
045	1.719	1.744	1.739
046	1.743	1.709	1.737
051	1.746	1.726	1.735
052	1.637	1.709	1.726
053	1.754	1.725	1.729
054	1.737	1.740	1.717
055	1.749	1.740	1.716
056	1.736	1.725	1.710
061	1.717	1.725	1.735
062	1.748	1.742	1.723
063	1.749	1.731	1.718
064	1.737	1.728	1.732
065	1.762	1.738	1.708
066	1.754	1.723	1.727
101	1.726	1.727	1.739
102	1.722	1.727	1.731
103	1.709	1.728	1.740
104	1.747	1.742	1.746
105	1.719	1.714	1.741
106	1.720	1.731	1.733
111	1.730	1.728	1.737
112	1.719	1.724	1.745

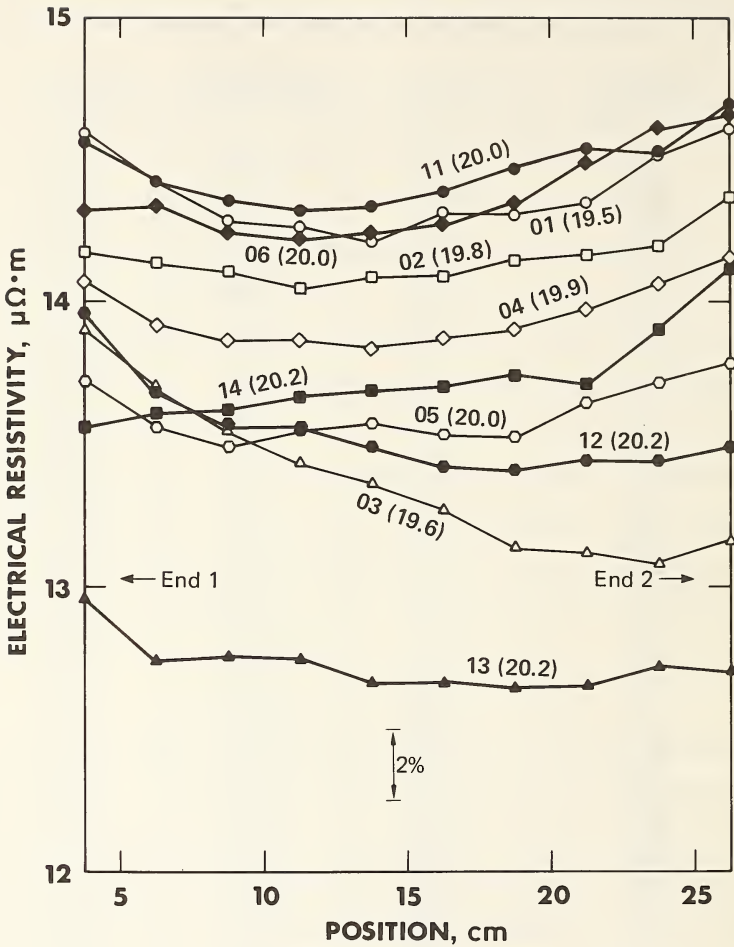

Figure 17. Electrical resistivity versus position of 25.4 mm diameter AXM graphite rods.



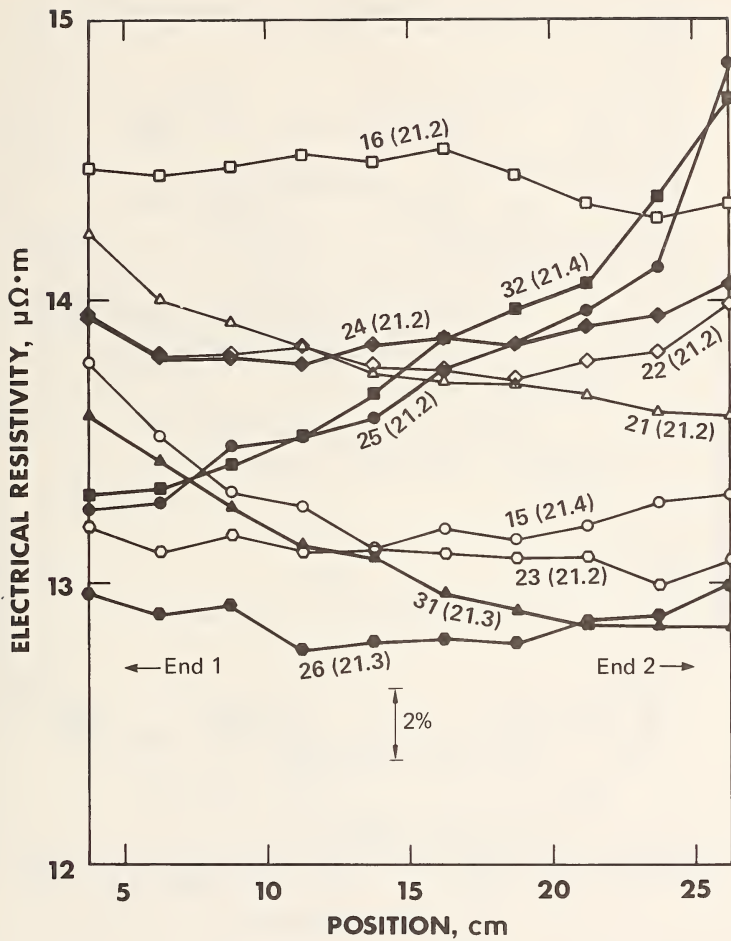

Figure 18. Electrical resistivity versus position of 25.4 mm diameter AXM graphite rods.

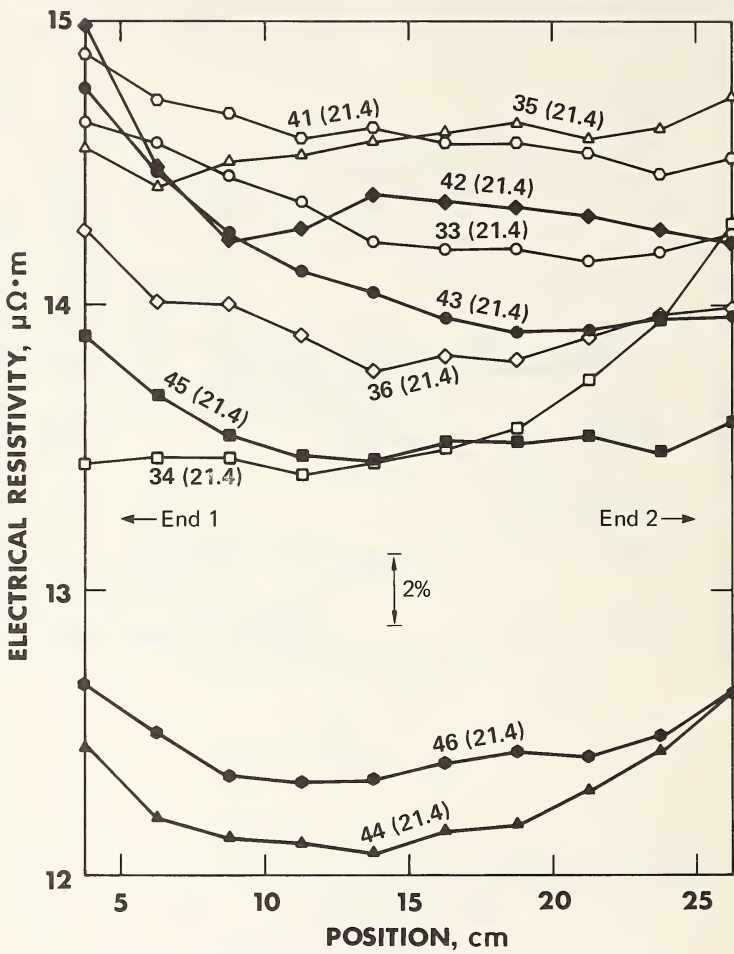

Figure 19. Electrical resistivity versus position of 25.4 mm diameter AXM graphite rods.

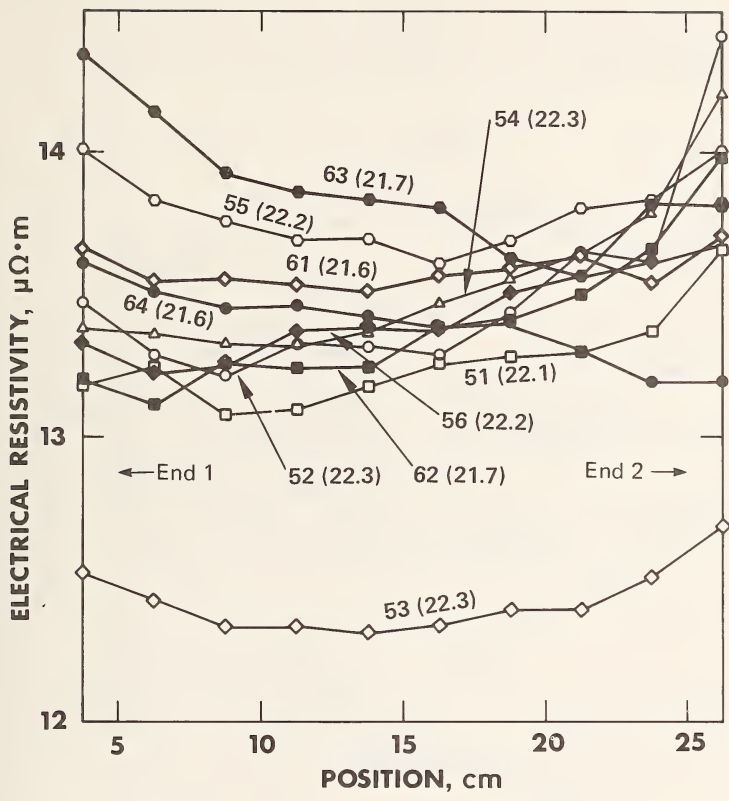

Figure 20. Electrical resistivity versus position of 25.4 mm diameter AXM graphite rods.

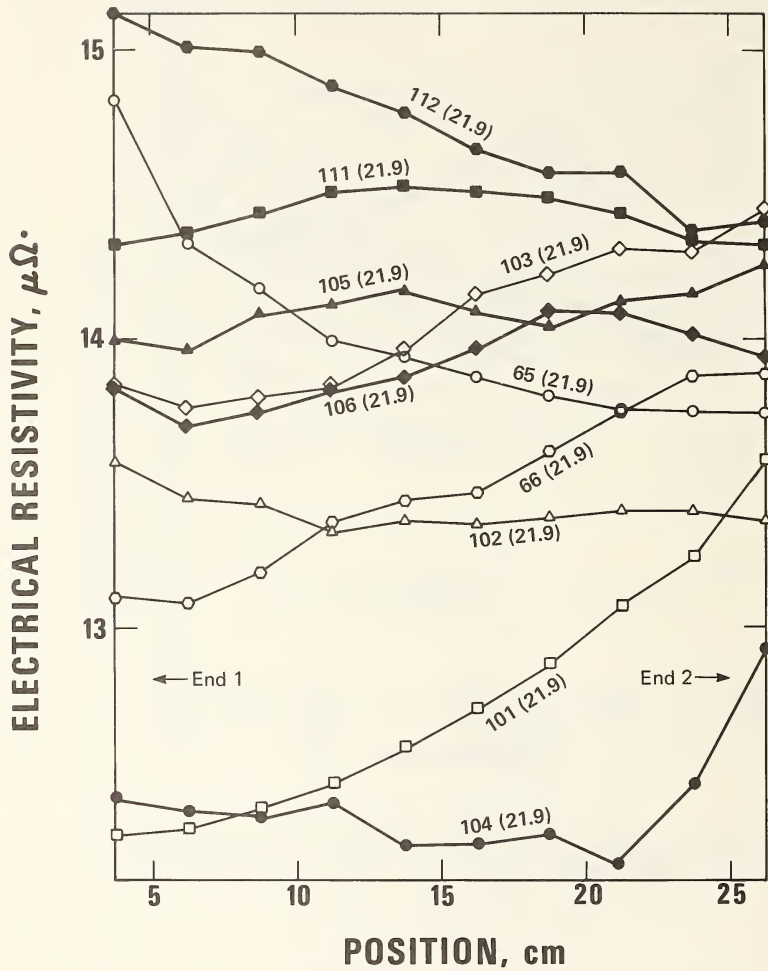

Figure 21. Electrical resistivity versus position of 25.4 mm diameter AXM graphite rods.

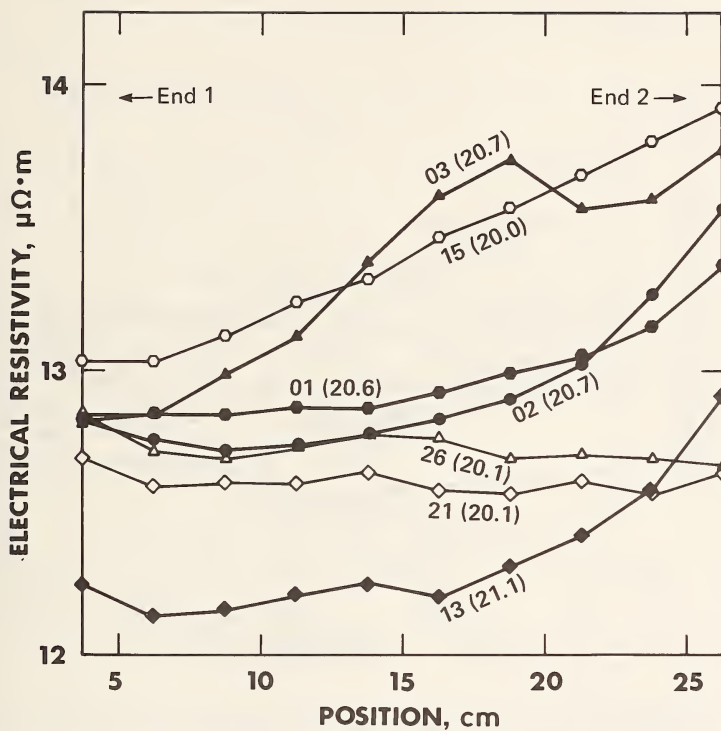

Figure 22. Electrical resistivity versus position of 12.7 mm diameter AXM graphite rods.

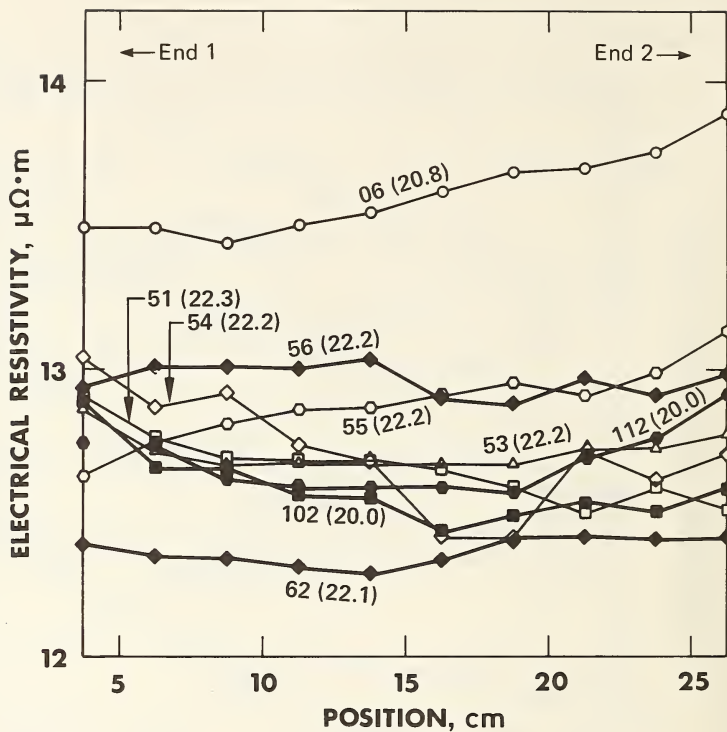

Figure 23. Electrical resistivity versus position of 12.7 mm diameter AXM graphite rods.

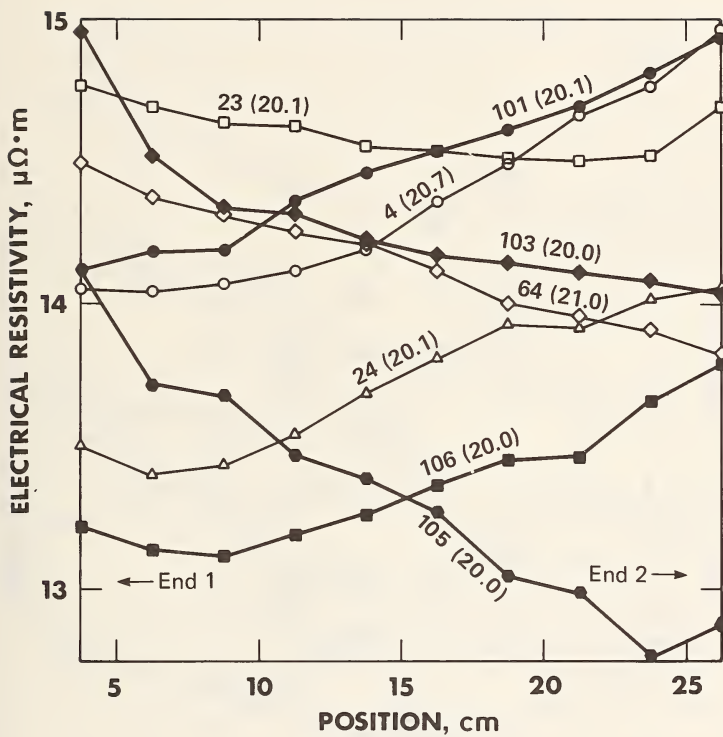

Figure 24. Electrical resistivity versus position of 12.7 mm diameter AXM graphite rods.



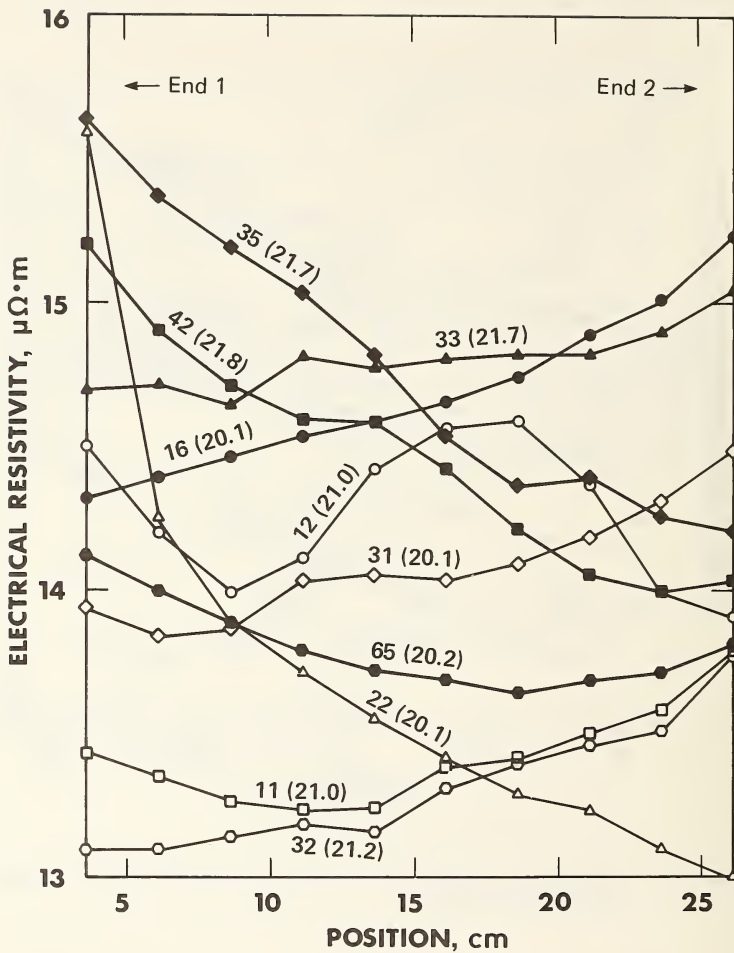

Figure 25. Electrical resistivity versus position of 12.7 mm diameter AXM graphite rods.

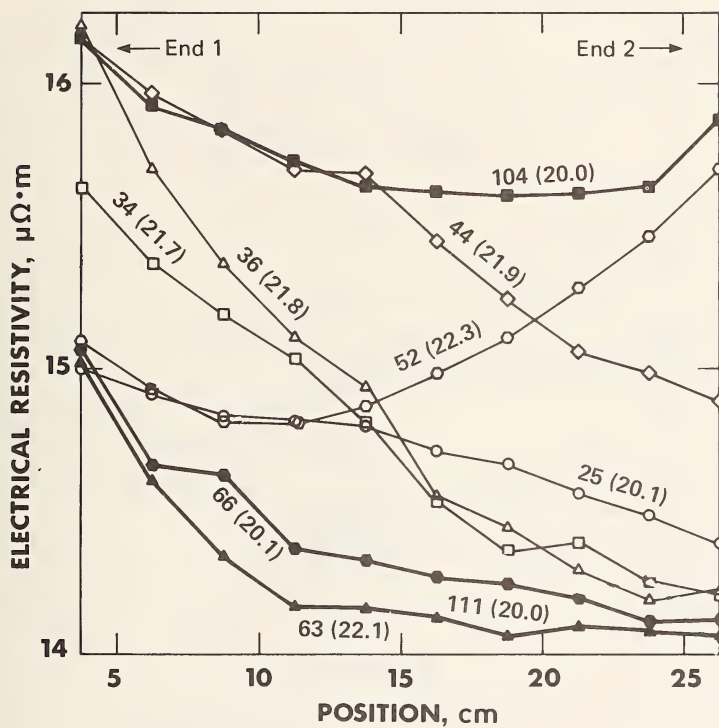

Figure 26. Electrical resistivity versus position of 12.7 mm diameter AXM graphite rods.

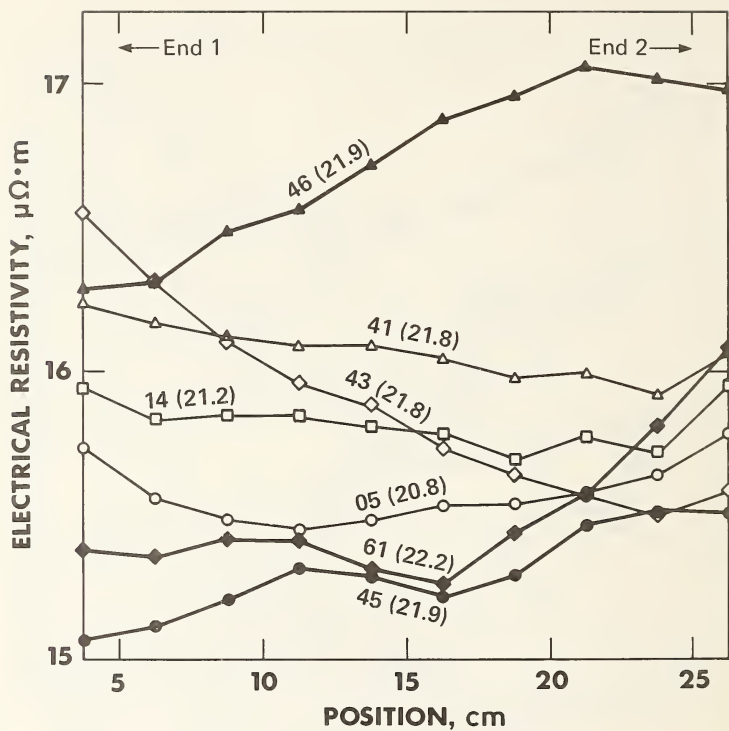

Figure 27. Electrical resistivity versus position of 12.7 mm diameter AXM graphite rods.

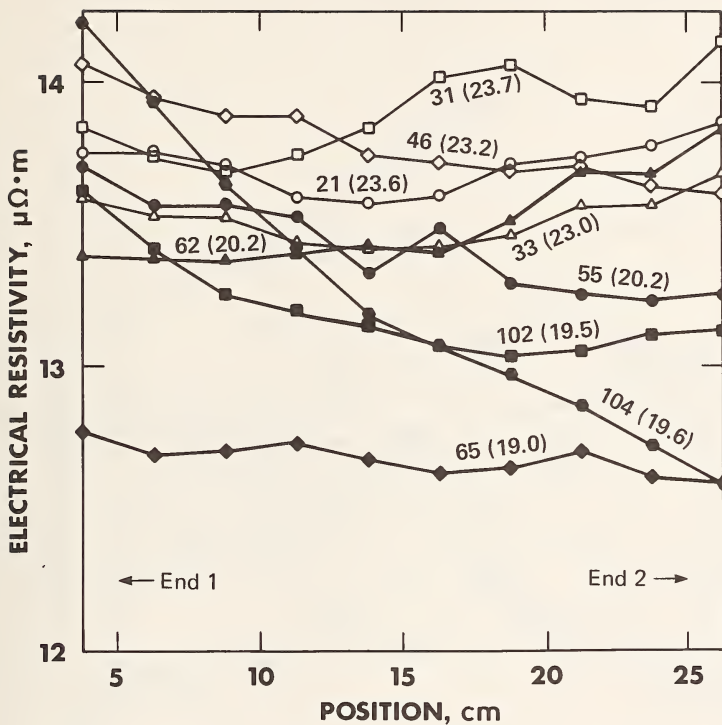

Figure 28. Electrical resistivity versus position of 6.4 mm diameter AXM graphite rods.

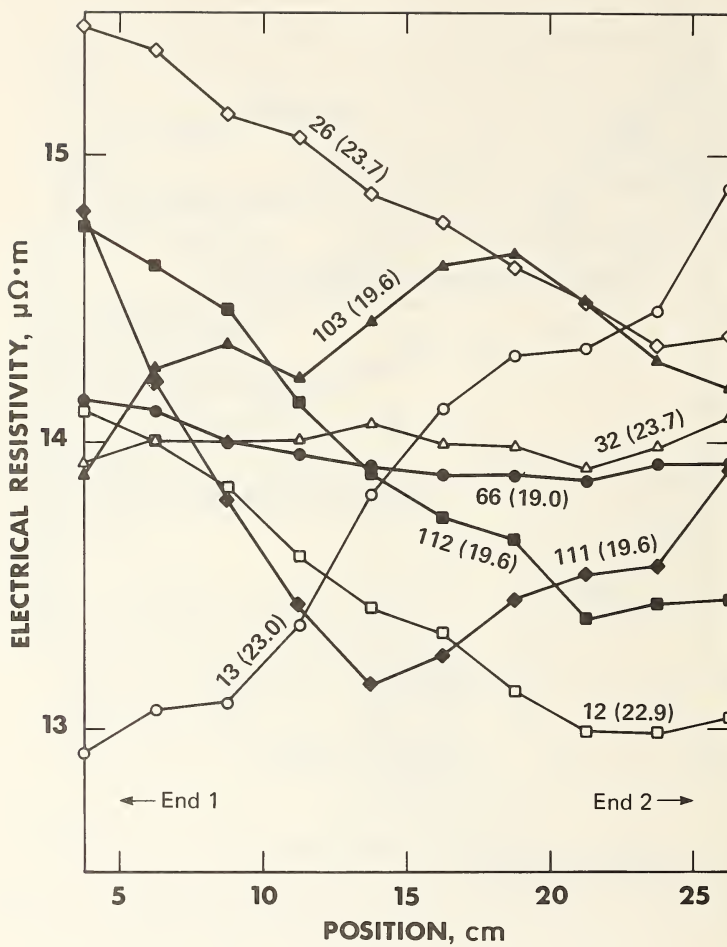

Figure 29. Electrical resistivity versus position of 6.4 mm diameter AXM graphite rods.

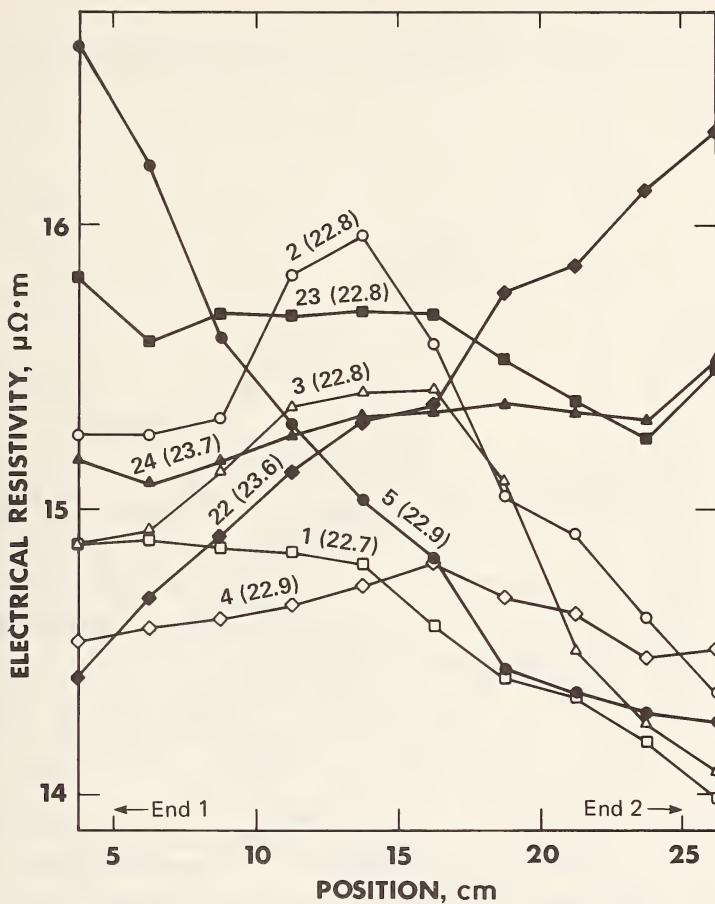

Figure 30. Electrical resistivity versus position of 6.4 mm diameter AXM graphite rods.

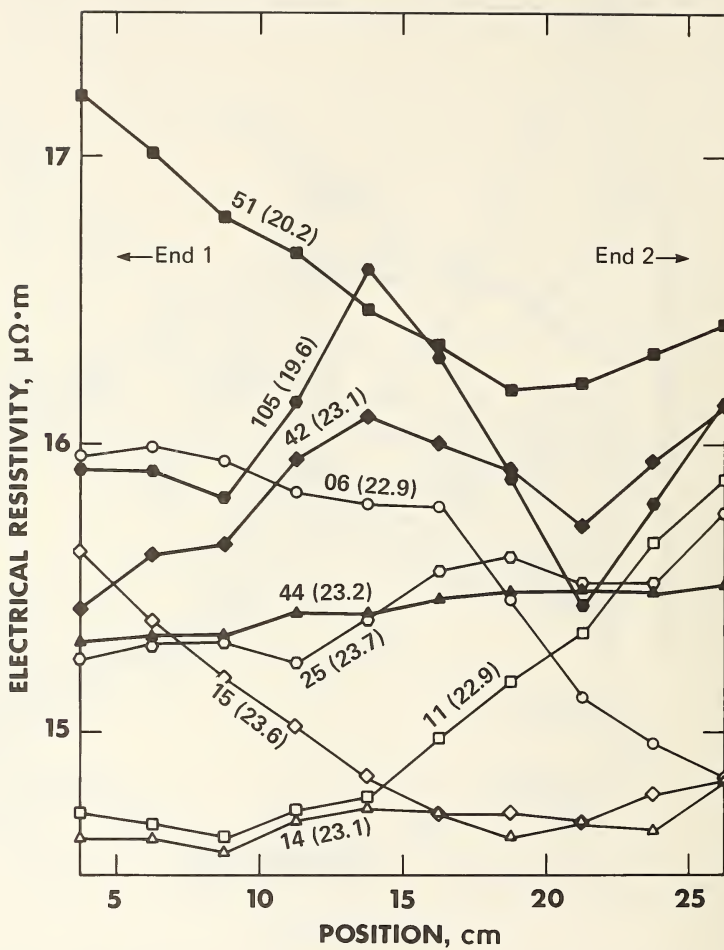

Figure 31. Electrical resistivity versus position of 6.4 mm diameter AXM graphite rods.



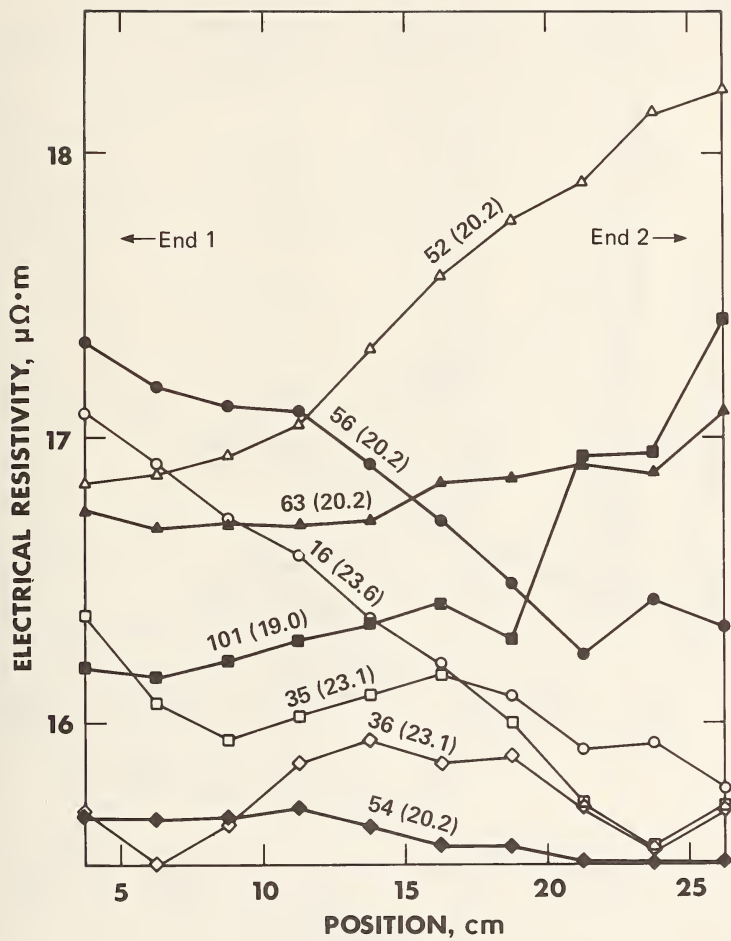

Figure 32. Electrical resistivity versus position of 6.4 mm diameter AXM graphite rods.

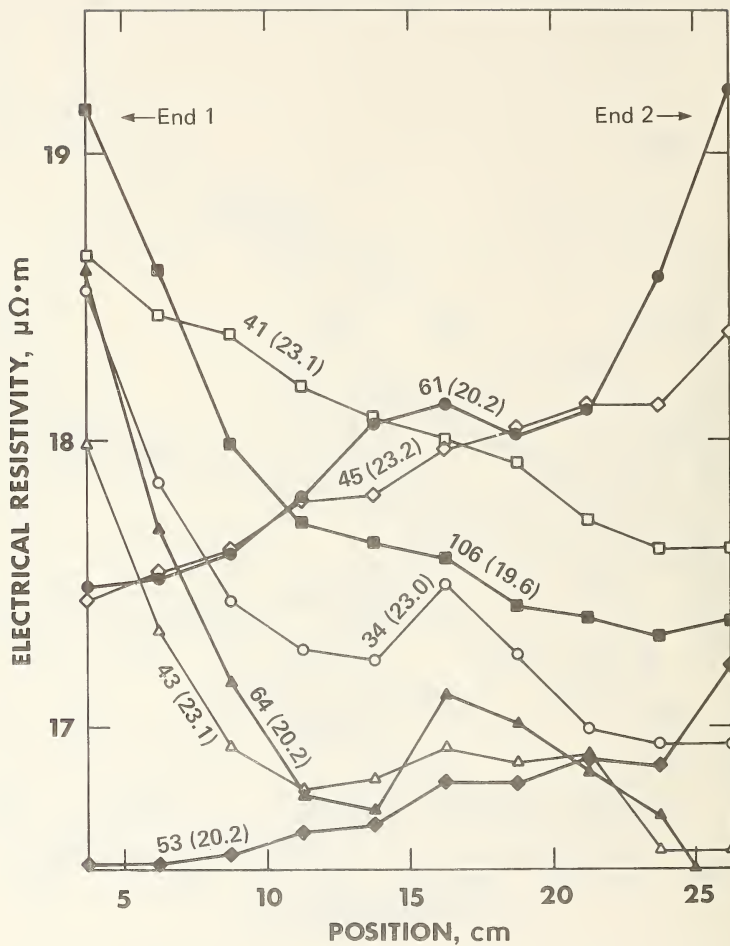

Figure 33. Electrical resistivity versus position of 6.4 mm diameter AXM graphite rods.

Table 5. Summary of reported results on AXM-5Q1 graphite.

Participant (Ref.)	*Properties Measured	Temperature Range (K)	Characterization Data	
			Density (g/cm <sup>3</sup> )	Electrical Resistivity ( $\mu\Omega\cdot\text{m}$ )
Brandt (6)	D	1100-2315	1.733	14.31
Brandt (6)	D	1085-2240	1.723	14.88
Hust (7)	$\lambda, \rho, S$	4-300	1.728	12.58
Hust (7)	$\lambda, \rho, S$	4-300	1.722	14.46
Hust (7)--13 specimens	$\lambda, \rho$	296 only	16.9 to 17.6	11.3 to 17.5
Isaacs 1 (8)	C	83-290	1.721	15.49
Maglic (9)	D	480-1713	1.755	14.59
Mirkovich (10)	D	273-1073	1.724	15.00
Moore (11)	$\lambda, S$	80-950	1.770	12.60
Taylor (12)	$\lambda, \rho, C, \alpha, D$	400-2400	1.744	13.80
Taylor (12)	"	"	1.789	13.00
Taylor (12)	"	300-2500	1.698	14.40
Taylor (13)	$\lambda, D$	530-2933	1.751	13.12
Taylor (13)	"	481-2247	1.707	15.29
Participant 1	C	373-873	1.757	---
Participant 1	$\rho, C$	1350-2900	1.706	18.81
Participant 3	$\lambda, \rho$	300-2100	1.738	13.39
Participant 4	D	553-2460	1.666	15.00
Participant 4	D	593-1343	1.666	15.00
Participant 5	$\lambda$	363-1067	1.696	14.20
Participant 5	$\lambda$	343-1124	1.708	13.50
Participant 5	$\lambda$	1085-2605	1.717	13.91
Participant 5	$\lambda$	1077-2615	1.716	14.40

\*D = thermal diffusivity,  $\lambda$  = thermal conductivity

$\rho$  = electrical resistivity,  $\alpha$  = thermal expansion, C = specific heat

S = Seebeck coefficient

The data from the participants are reported in various forms. Some data are in SI units and others are in British units, some are corrected for thermal expansion and others are not, some are closely-spaced direct experimental values and others are more widely-spaced smoothed values. To achieve sets of data for convenient comparison and representation, the following modifications were performed:

1. All data were converted to SI units.
2. All data known to be uncorrected for thermal expansion were corrected with the following equations:

$$\lambda = \lambda_{\text{obs}} / (1 + \Delta L/L)$$

$$\rho = \rho_{\text{obs}} (1 + \Delta L/L)$$

$$D = D_{\text{obs}} (1 + \Delta L/L)^2$$

The values for  $\Delta L/L$  were taken from Touloukian et al. (14). The corrections amount to -0.2% at 0 K, 0% at 293 K, and 2.1% at 2600 K.

3. When very closely-spaced data were reported, a subset was selected that  
a) covered the entire reported range, b) reflected the scatter in the entire data set, and c) was spaced in temperature for convenient graphical illustration with no loss in the detailed temperature dependence.

All of the data reported and modified in this way are given in Tables 6 through 19.

## 5. PHASE IV - DATA ANALYSIS AND RECOMMENDED VALUES

### 5.1 Thermal Conductivity

Figures 34 through 37 show the thermal conductivity data from Tables 6 through 19. It is clear that large variations in  $\lambda$  exist throughout the

TABLE 6. THERMOPHYSICAL PROPERTIES FOR AXM-5Q1 GRAPHITE AS REPORTED BY BRANDT (6).

TEMPERATURE (K)	THERMAL CONDUCTIVITY ( $W \cdot m^{-1} \cdot K^{-1}$ )	ELECTRICAL RESISTIVITY ( $\mu\Omega \cdot m$ )	SPECIFIC HEAT ( $J \cdot g^{-1} \cdot K^{-1}$ )	DENSITY ( $kg \cdot m^{-3}$ )	THERMAL DIFFUSIVITY ( $\mu m^2 \cdot s^{-1}$ )	SEEBECK COEFFICIENT ( $\mu V \cdot K^{-1}$ )
SPEC. 42F, RESISTIVITY = 14.31, DENSITY = 1733						
1110.					15.82	
1202.					14.91	
1333.					13.72	
1450.					12.91	
1560.					12.26	
1669.					11.83	
1783.					11.05	
1910.					10.65	
2045.					10.20	
2163.					9.83	
2275.					9.59	
2315.					9.44	
1333.					13.04	
SPEC. 112C, RESISTIVITY = 14.88, DENSITY = 1723						
1085.					17.08	
1148.					16.51	
1222.					15.64	
1335.					14.59	
1490.					13.55	
1605.					12.91	
1770.					11.89	
1915.					11.52	
2100.					10.73	
2240.					10.08	

TABLE 7. THERMOPHYSICAL PROPERTIES FOR AXM-5Q1 GRAPHITE AS REPORTED BY PARTICIPANT 1, SPEC. 62, ROOM TEMPERATURE ELECTRICAL RESISTIVITY =  $12.40 \mu\Omega \cdot m$ , DENSITY =  $1757 kg \cdot m^{-3}$ .

TEMPERATURE (K)	THERMAL CONDUCTIVITY ( $W \cdot m^{-1} \cdot K^{-1}$ )	ELECTRICAL RESISTIVITY ( $\mu\Omega \cdot m$ )	SPECIFIC HEAT ( $J \cdot g^{-1} \cdot K^{-1}$ )	DENSITY ( $kg \cdot m^{-3}$ )	THERMAL DIFFUSIVITY ( $\mu m^2 \cdot s^{-1}$ )	SEEBECK COEFFICIENT ( $\mu V \cdot K^{-1}$ )
400.0			999.4			
500.0			1207.3			
600.0			1395.4			
700.0			1533.4			
800.0			1651.5			
900.0			1739.7			
1000.			1797.8			
1200.			1824.4			

TABLE 8. THERMOPHYSICAL PROPERTIES FOR AXM-5Q1 GRAPHITE AS REPORTED BY HUST (7).

TEMPERATURE (K)	THERMAL CONDUCTIVITY ( $W \cdot m^{-1} \cdot K^{-1}$ )	ELECTRICAL RESISTIVITY ( $\mu\Omega \cdot m$ )	SPECIFIC HEAT ( $J \cdot g^{-1} \cdot K^{-1}$ )	DENSITY ( $kg \cdot m^{-3}$ )	THERMAL DIFFUSIVITY ( $\mu m^2 \cdot s^{-1}$ )	SEEBECK COEFFICIENT ( $\mu V \cdot K^{-1}$ )
296.0	SPEC. 310-0 .7280E+02	17.50		1693.		
296.8	SPEC. 310-1 .7300E+02	17.50		1689.		
296.7	SPEC. 310-2 .7370E+02	17.50		1690.		
296.9	SPEC. 310-3 .7380E+02	17.50		1698.		
296.4	SPEC. 310-4 .7440E+02	17.50		1702.		
296.7	SPEC. 520 .1057E+03	12.90		1731.		
296.3	SPEC. 400 .1219E+03	11.30		1755.		
296.6	SPEC. 410 .1180E+03	11.60		1736.		
296.4	SPEC. 102 .1126E+03	12.60		1755.		
296.2	SPEC. 401 .1025E+03	13.00		1716.		
297.0	SPEC. 100 .9700E+02	14.40		1755.		
296.5	SPEC. 311 .9510E+02	13.90		1722.		
296.9	SPEC. 312 .9250E+02	15.30		1757.		

TABLE 9. THERMOPHYSICAL PROPERTIES FOR AXM-5Q1 GRAPHITE AS REPORTED BY HUST (7).

TEMPERATURE (K)	THERMAL CONDUCTIVITY ( $W \cdot m^{-1} \cdot K^{-1}$ )	ELECTRICAL RESISTIVITY ( $\mu\Omega \cdot m$ )	SPECIFIC HEAT ( $J \cdot g^{-1} \cdot K^{-1}$ )	DENSITY ( $kg \cdot m^{-3}$ )	THERMAL DIFFUSIVITY ( $\mu m^2 \cdot s^{-1}$ )	SEEBECK COEFFICIENT ( $\mu V \cdot K^{-1}$ )
SPEC. 013, RESISTIVITY = 12.58, DENSITY = 1728						
6.000	.6332E-01	26.58				-3.294
7.000	.9258E-01	26.54				-3.870
8.000	.1293E+00	26.49				-4.410
9.000	.1743E+00	26.44				-4.932
10.00	.2284E+00	26.38				-5.418
12.00	.3687E+00	26.25				-6.300
14.00	.5521E+00	26.11				-7.092
16.00	.7845E+00	25.97				-7.758
18.00	.1062E+01	25.82				-8.334
20.00	.1403E+01	25.67				-8.802
25.00	.2465E+01	25.27				-9.594
30.00	.3847E+01	24.85				-9.918
35.00	.5560E+01	24.45				-9.918
40.00	.7553E+01	24.03				-9.684
45.00	.9827E+01	23.61				-9.306
50.00	.1232E+02	23.21				-8.856
60.00	.1793E+02	22.42				-7.812
70.00	.2414E+02	21.68				-6.732
80.00	.3065E+02	20.97				-5.688
90.00	.3735E+02	20.30				-4.716
100.0	.4416E+02	19.67				-3.816
120.0	.5727E+02	18.55				-2.214
140.0	.6927E+02	17.54				-.828
160.0	.7957E+02	16.65				.360
180.0	.8797E+02	15.86				1.386
200.0	.9456E+02	15.15				2.268
220.0	.9955E+02	14.51				3.006
240.0	.1030E+03	13.93				3.600
260.0	.1050E+03	13.41				4.050
280.0	.1070E+03	12.92				4.356
SPEC. 035, RESISTIVITY = 14.46, DENSITY = 1722						
5.000	.3487E-01	28.77				-2.376
6.000	.5341E-01	28.74				-2.952
7.000	.7795E-01	28.69				-3.456
8.000	.1092E+00	28.64				-3.924
9.000	.1473E+00	28.59				-4.356
10.00	.1924E+00	28.53				-4.752
12.00	.3096E+00	28.41				-5.454
14.00	.4629E+00	28.28				-6.084
16.00	.6552E+00	28.13				-6.606
18.00	.8887E+00	27.99				-7.056
20.00	.1162E+01	27.83				-7.434
25.00	.2044E+01	27.44				-8.010
30.00	.3196E+01	27.04				-8.208
35.00	.4608E+01	26.64				-8.136
40.00	.6251E+01	26.23				-7.902
45.00	.8094E+01	25.84				-7.560
50.00	.1012E+02	25.45				-7.164
60.00	.1462E+02	24.68				-6.246
70.00	.1963E+02	23.95				-5.292
80.00	.2494E+02	23.26				-4.356
90.00	.3034E+02	22.60				-3.456
100.0	.3595E+02	21.97				-2.628
120.0	.4686E+02	20.80				-1.134
140.0	.5686E+02	19.77				.180
160.0	.6546E+02	18.83				1.296
180.0	.7266E+02	18.00				2.304
200.0	.7845E+02	17.23				3.186
220.0	.8304E+02	16.54				3.960
240.0	.8643E+02	15.92				4.590
260.0	.8902E+02	15.36				5.112
280.0	.9051E+02	14.85				5.490
300.0	.9080E+02	14.38				5.742



TABLE 10. THERMOPHYSICAL PROPERTIES FOR AXM-5Q1 GRAPHITE AS REPORTED BY ISAACS (8), SPEC. 103-2, ROOM TEMPERATURE ELECTRICAL RESISTIVITY = 15.49  $\mu\Omega\cdot m$ , DENSITY = 1721  $kg\cdot m^{-3}$ .

TEMPERATURE (K)	THERMAL CONDUCTIVITY ( $W\cdot m^{-1}\cdot K^{-1}$ )	ELECTRICAL RESISTIVITY ( $\mu\Omega\cdot m$ )	SPECIFIC HEAT ( $J\cdot g^{-1}\cdot K^{-1}$ )	DENSITY ( $kg\cdot m^{-3}$ )	THERMAL DIFFUSIVITY ( $\mu m^2\cdot s^{-1}$ )	SEEBECK COEFFICIENT ( $\mu V\cdot K^{-1}$ )
82.80			117.			
89.96			156.			
95.38			147.			
111.2			180.			
125.5			223.			
142.7			265.			
160.5			308.			
181.9			423.			
194.3			459.			
215.7			573.			
239.0			659.			
260.8			760.			
279.6			875.			
289.4			955.			

TABLE 11. THERMOPHYSICAL PROPERTIES FOR AXM-5Q1 GRAPHITE AS REPORTED BY MAGLIC (9), SPEC. 4, ROOM TEMPERATURE ELECTRICAL RESISTIVITY = 14.59  $\mu\Omega\cdot m$ , DENSITY = 1755  $kg\cdot m^{-3}$ .

TEMPERATURE (K)	THERMAL CONDUCTIVITY ( $W\cdot m^{-1}\cdot K^{-1}$ )	ELECTRICAL RESISTIVITY ( $\mu\Omega\cdot m$ )	SPECIFIC HEAT ( $J\cdot g^{-1}\cdot K^{-1}$ )	DENSITY ( $kg\cdot m^{-3}$ )	THERMAL DIFFUSIVITY ( $\mu m^2\cdot s^{-1}$ )	SEEBECK COEFFICIENT ( $\mu V\cdot K^{-1}$ )
480.0					41.50	
577.0					33.50	
677.0					28.50	
762.0					25.10	
866.0					21.50	
996.0					18.90	
1112.					16.90	
1224.					15.70	
1339.					14.60	
1458.					13.60	
1558.					12.70	
1647.					12.20	
1713.					11.80	

TABLE 12. THERMOPHYSICAL PROPERTIES FOR AXM-5Q1 GRAPHITE AS REPORTED BY MIRKOVICH (10), SPEC. 112B, ROOM TEMPERATURE ELECTRICAL RESISTIVITY = 15.00  $\mu\Omega\cdot m$ , DENSITY = 1724  $kg\cdot m^{-3}$ .

TEMPERATURE (K)	THERMAL CONDUCTIVITY ( $W\cdot m^{-1}\cdot K^{-1}$ )	ELECTRICAL RESISTIVITY ( $\mu\Omega\cdot m$ )	SPECIFIC HEAT ( $J\cdot g^{-1}\cdot K^{-1}$ )	DENSITY ( $kg\cdot m^{-3}$ )	THERMAL DIFFUSIVITY ( $\mu m^2\cdot s^{-1}$ )	SEEBECK COEFFICIENT ( $\mu V\cdot K^{-1}$ )
273.2					72.50	
323.2					58.10	
373.2					48.70	
473.2					37.60	
573.2					30.30	
673.2					25.70	
773.2					22.40	
873.2					19.70	
973.1					17.60	
1073.					16.10	

TABLE 13. THERMOPHYSICAL PROPERTIES FOR AXM-5Q1 GRAPHITE AS REPORTED BY MOORE (11), SPEC. 102, ROOM TEMPERATURE ELECTRICAL RESISTIVITY = 12.60  $\mu\Omega\cdot\text{m}$ , DENSITY = 1770  $\text{kg}\cdot\text{m}^{-3}$ .

TEMPERATURE (K)	THERMAL CONDUCTIVITY ( $\text{W}\cdot\text{m}^{-1}\cdot\text{K}^{-1}$ )	ELECTRICAL RESISTIVITY ( $\mu\Omega\cdot\text{m}$ )	SPECIFIC HEAT ( $\text{J}\cdot\text{g}^{-1}\cdot\text{K}^{-1}$ )	DENSITY ( $\text{kg}\cdot\text{m}^{-3}$ )	THERMAL DIFFUSIVITY ( $\mu\text{m}^2\cdot\text{s}^{-1}$ )	SEEBECK COEFFICIENT ( $\mu\text{V}\cdot\text{K}^{-1}$ )
80.00	.2960E+02					-5.094
100.0	.4300E+02					-3.564
120.0	.5610E+02					-2.106
140.0	.6800E+02					-.774
160.0	.7840E+02					.414
180.0	.8710E+02					1.458
200.0	.9410E+02					2.340
220.0	.9950E+02					3.078
240.0	.1035E+03					3.762
260.0	.1062E+03					4.122
280.0	.1078E+03					4.446
300.0	.1084E+03	12.51				4.644
320.0	.1083E+03					4.716
340.0	.1082E+03					4.698
360.0	.1075E+03					4.572
380.0	.1065E+03					4.356
400.0	.1053E+03	10.92				4.050
500.0	.9830E+02	10.01				1.782
600.0	.8830E+02	9.36				-1.098
700.0	.8010E+02	8.93				-3.654
800.0	.7460E+02	8.66				-5.724
900.0	.6820E+02	8.52				-6.372
950.0	.6590E+02					

TABLE 14. THERMOPHYSICAL PROPERTIES FOR AXM-5Q1 GRAPHITE AS REPORTED BY PARTICIPANT 5.

TEMPERATURE (K)	THERMAL CONDUCTIVITY ( $\text{W}\cdot\text{m}^{-1}\cdot\text{K}^{-1}$ )	ELECTRICAL RESISTIVITY ( $\mu\Omega\cdot\text{m}$ )	SPECIFIC HEAT ( $\text{J}\cdot\text{g}^{-1}\cdot\text{K}^{-1}$ )	DENSITY ( $\text{kg}\cdot\text{m}^{-3}$ )	THERMAL DIFFUSIVITY ( $\mu\text{m}^2\cdot\text{s}^{-1}$ )	SEEBECK COEFFICIENT ( $\mu\text{V}\cdot\text{K}^{-1}$ )
SPEC. 006(CRA-1), RESISTIVITY = 14.20, DENSITY = 1696						
363.2	.8732E+02					
372.0	.8920E+02					
538.7	.8070E+02					
803.7	.6225E+02					
1067.	.5029E+02					
SPEC. 32C(CRA-2), RESISTIVITY = 13.50, DENSITY = 1708						
343.2	.9136E+02					
508.7	.8387E+02					
807.0	.6614E+02					
1124.	.5058E+02					
SPEC. 32C(RIA-2A), RESISTIVITY = 13.91, DENSITY = 1717						
1085.	.5058E+02					
1380.	.4222E+02					
1929.	.3401E+02					
2606.	.2968E+02					
SPEC. 006(RIA-1A), RESISTIVITY = 14.40, DENSITY = 1716						
1077.	.5361E+02					
1115.	.4799E+02					
1366.	.3920E+02					
1524.	.3876E+02					
1877.	.3285E+02					
2001.	.2853E+02					
2613.	.2853E+02					
2615.	.3041E+02					

TABLE 15. THERMOPHYSICAL PROPERTIES FOR AXM-5Q1 GRAPHITE AS REPORTED BY PARTICIPANT 2,  
SPEC. 41B, ROOM TEMPERATURE ELECTRICAL RESISTIVITY = 18.81  $\mu\Omega\cdot m$ , DENSITY  
= 1706  $kg\cdot m^{-3}$ .

TEMPERATURE (K)	THERMAL CONDUCTIVITY ( $W\cdot m^{-1}\cdot K^{-1}$ )	ELECTRICAL RESISTIVITY ( $\mu\Omega\cdot m$ )	SPECIFIC HEAT ( $J\cdot g^{-1}\cdot K^{-1}$ )	DENSITY ( $kg\cdot m^{-3}$ )	THERMAL DIFFUSIVITY ( $\mu m^2\cdot s^{-1}$ )	SEEBECK COEFFICIENT ( $\mu V\cdot K^{-1}$ )
1350.		11.23	1933.			
1400.		11.26	1947.			
1500.		11.33	1969.			
1600.		11.43	1990.			
1700.		11.56	2008.			
1800.		11.70	2022.			
1900.		11.86	2039.			
2000.		12.02	2053.			
2100.		12.20	2066.			
2200.		12.36	2076.			
2300.		12.53	2086.			
2400.		12.71	2096.			
2500.		12.89	2104.			
2600.		13.06	2112.			
2700.		13.23	2120.			
2800.		13.40	2122.			
2900.		13.58	2130.			

TABLE 16. THERMOPHYSICAL PROPERTIES FOR AXM-5Q1 GRAPHITE AS REPORTED BY PARTICIPANT 3,  
SPEC. 52, ROOM TEMPERATURE ELECTRICAL RESISTIVITY = 13.39  $\mu\Omega\cdot m$ , DENSITY  
= 1738  $kg\cdot m^{-3}$ .

TEMPERATURE (K)	THERMAL CONDUCTIVITY ( $W\cdot m^{-1}\cdot K^{-1}$ )	ELECTRICAL RESISTIVITY ( $\mu\Omega\cdot m$ )	SPECIFIC HEAT ( $J\cdot g^{-1}\cdot K^{-1}$ )	DENSITY ( $kg\cdot m^{-3}$ )	THERMAL DIFFUSIVITY ( $\mu m^2\cdot s^{-1}$ )	SEEBECK COEFFICIENT ( $\mu V\cdot K^{-1}$ )
300.0		13.62				
400.0	.9240E+02	12.14				
500.0	.8770E+02	10.99				
600.0	.8150E+02	10.25				
700.0	.7580E+02	9.70				
800.0	.7110E+02	9.36				
900.0	.6690E+02	9.10				
1000.	.6230E+02	8.90				
1100.	.5800E+02	8.81				
1200.	.5390E+02	8.83				
1300.	.5030E+02	8.97				
1400.		9.09				
1500.		9.26				
1600.		9.42				
1700.		9.61				
1800.		9.80				
1900.		9.98				
2000.		10.16				
2100.		10.34				

TABLE 17. THERMOPHYSICAL PROPERTIES FOR AXM-5Q1 GRAPHITE AS REPORTED BY TAYLOR (12).

TEMPERATURE (K)	THERMAL CONDUCTIVITY ( $W \cdot m^{-1} \cdot K^{-1}$ )	ELECTRICAL RESISTIVITY ( $\mu\Omega \cdot m$ )	SPECIFIC HEAT ( $J \cdot g^{-1} \cdot K^{-1}$ )	DENSITY ( $kg \cdot m^{-3}$ )	THERMAL DIFFUSIVITY ( $\mu m^2 \cdot s^{-1}$ )	SEEBECK COEFFICIENT ( $\mu V \cdot K^{-1}$ )
SPEC. 3A-1, RESISTIVITY = 13.80, DENSITY = 1744						
400.0	.9720E+02	12.13	957.	1737.	58.50	
500.0	.8920E+02	11.06	1168.	1734.	44.00	
600.0	.8280E+02	10.36	1382.	1713.	34.60	
700.0	.7730E+02	9.88	1520.	1727.	29.40	
800.0	.7250E+02	9.50	1636.	1722.	25.70	
900.0	.6730E+02	9.34	1726.	1718.	22.70	
1000.	.6280E+02	9.30	1797.	1714.	20.40	
1100.	.5860E+02	9.31	1859.	1709.	18.30	
1200.	.5470E+02	9.39	1905.	1705.	16.80	
1300.	.5120E+02	9.48	1942.	1700.	15.50	
1400.	.4820E+02	9.64	1975.	1696.	14.40	
1500.	.4560E+02	9.80	2002.	1692.	13.50	
1600.	.4360E+02	9.96	2028.	1687.	12.70	
1700.	.4210E+02	10.15	2050.	1682.	12.20	
1800.	.4080E+02	10.35	2070.	1677.	11.80	
1900.	.3980E+02	10.57	2087.	1673.	11.40	
2000.	.3880E+02	10.81	2100.	1668.	11.10	
2100.	.3800E+02	11.04	2111.	1663.	10.80	
2200.	.3740E+02	11.27	2127.	1658.	10.60	
2300.	.3700E+02	11.46	2140.	1653.	10.50	
2400.	.3650E+02	11.68	2155.	1647.	10.30	
SPEC. 3A-2, RESISTIVITY = 13.00, DENSITY = 1789						
400.0	.1022E+03	11.28		1781.	60.00	
500.0	.9530E+02	10.24		1777.	45.90	
600.0	.8870E+02	9.54		1774.	36.20	
700.0	.8230E+02	9.06		1770.	30.60	
800.0	.7680E+02	8.76		1766.	26.60	
900.0	.7170E+02	8.59		1761.	23.60	
1000.	.6680E+02	8.54		1757.	21.20	
1100.	.6250E+02	8.52		1752.	19.20	
1200.	.5890E+02	8.57		1748.	17.70	
1300.	.5530E+02	8.67		1743.	16.30	
1400.	.5210E+02	8.78		1739.	15.20	
1500.	.4930E+02	8.94		1734.	14.20	
1600.	.4710E+02	9.10		1729.	13.40	
1700.	.4530E+02	9.26		1725.	12.80	
1800.	.4360E+02	9.45		1720.	12.20	
1900.	.4230E+02	9.65		1715.	11.80	
2000.	.4140E+02	9.85		1710.	11.50	
2100.	.4060E+02	10.06		1705.	11.30	
2200.	.4000E+02	10.29		1699.	11.10	
2300.	.3940E+02	10.53		1694.	10.90	
2400.	.3900E+02	10.77		1689.	10.70	
SPEC. 001, RESISTIVITY = 14.40, DENSITY = 1698						
300.0	.1005E+03	14.30	702.	1698.	84.30	
400.0	.9350E+02	12.59		1695.	57.60	
500.0	.8650E+02	11.48		1691.	43.70	
600.0	.8040E+02	10.75		1688.	34.50	
700.0	.7470E+02	10.31		1684.	29.20	
800.0	.6980E+02	9.96		1680.	25.40	
900.0	.6470E+02	9.76		1676.	22.40	
1000.	.6040E+02	9.70		1672.	20.10	
1100.	.5600E+02	9.71		1668.	18.10	
1200.	.5220E+02	9.87		1664.	16.50	
1300.	.4860E+02	10.13		1660.	15.10	
1400.	.4570E+02	10.34		1655.	14.00	
1500.	.4330E+02	10.55		1650.	13.10	
1600.	.4110E+02	10.76		1646.	12.30	
1700.	.3960E+02	10.98		1641.	11.80	
1800.	.3820E+02	11.20		1636.	11.30	
1900.	.3700E+02	11.41		1631.	10.90	
2000.	.3610E+02	11.65		1626.	10.60	
2100.	.3540E+02	11.85		1621.	10.30	
2200.	.3480E+02	12.10		1616.	10.10	
2300.	.3430E+02	12.44		1611.	9.90	
2400.	.3400E+02	12.64		1606.	9.80	
2500.	.3350E+02	12.83	2168.	1601.	9.70	

TABLE 18. THERMOPHYSICAL PROPERTIES FOR AXM-5Q1 GRAPHITE AS REPORTED BY TAYLOR (13).

TEMPERATURE (K)	THERMAL CONDUCTIVITY ( $W \cdot m^{-1} \cdot K^{-1}$ )	ELECTRICAL RESISTIVITY ( $\mu\Omega \cdot m$ )	SPECIFIC HEAT ( $J \cdot g^{-1} \cdot K^{-1}$ )	DENSITY ( $kg \cdot m^{-3}$ )	THERMAL DIFFUSIVITY ( $\mu m^2 \cdot s^{-1}$ )	SEEBECK COEFFICIENT ( $\mu V \cdot K^{-1}$ )
SPEC. 102, RESISTIVITY = 13.12, DENSITY = 1751						
530.0	.8350E+02				37.40	
615.0	.7720E+02				31.30	
733.0	.7130E+02				25.90	
863.0	.6620E+02				22.30	
989.0	.6100E+02				19.50	
1113.	.5740E+02				17.90	
1315.	.5130E+02				15.40	
1423.	.4860E+02				14.40	
1575.	.4490E+02				13.20	
1717.	.4320E+02				12.50	
1890.	.3840E+02				11.10	
1982.	.3900E+02				11.20	
2155.	.3760E+02				10.70	
2318.	.3450E+02				9.82	
2410.	.3470E+02				9.87	
2503.	.3100E+02				8.80	
2615.	.3290E+02				9.35	
2705.	.2920E+02				8.30	
2810.	.2920E+02				8.31	
2933.	.3040E+02				8.62	
SPEC. 401, RESISTIVITY = 15.29, DENSITY = 1707						
481.0	.8380E+02				41.30	
596.0	.8090E+02				33.50	
1220.	.5430E+02				16.50	
1392.	.4900E+02				14.70	
1504.	.4610E+02				13.60	
1615.	.4400E+02				12.80	
1788.	.4230E+02				12.20	
1839.	.3850E+02				11.10	
1992.	.4140E+02				11.90	
2094.	.3900E+02				11.10	
2186.	.3720E+02				10.60	
2247.	.3740E+02				10.70	

TABLE 19. THERMOPHYSICAL PROPERTIES FOR AXM-5Q1 GRAPHITE AS REPORTED BY PARTICIPANT 4, SPEC. 111-ENQ 1, ROOM TEMPERATURE ELECTRICAL RESISTIVITY = 15.00  $\mu\Omega \cdot m$ , DENSITY = 1666  $kg \cdot m^{-3}$ .

TEMPERATURE (K)	THERMAL CONDUCTIVITY ( $W \cdot m^{-1} \cdot K^{-1}$ )	ELECTRICAL RESISTIVITY ( $\mu\Omega \cdot m$ )	SPECIFIC HEAT ( $J \cdot g^{-1} \cdot K^{-1}$ )	DENSITY ( $kg \cdot m^{-3}$ )	THERMAL DIFFUSIVITY ( $\mu m^2 \cdot s^{-1}$ )	SEEBECK COEFFICIENT ( $\mu V \cdot K^{-1}$ )
553.2					29.60	
732.2					22.60	
868.2					20.30	
1049.					16.70	
1225.					14.50	
1421.					12.80	
1598.					12.09	
1824.					10.60	
2020.					10.90	
2220.					8.90	
2460.					8.10	
593.2					27.10	
868.2					19.20	
1005.					17.30	
1188.					15.70	
1343.					13.60	

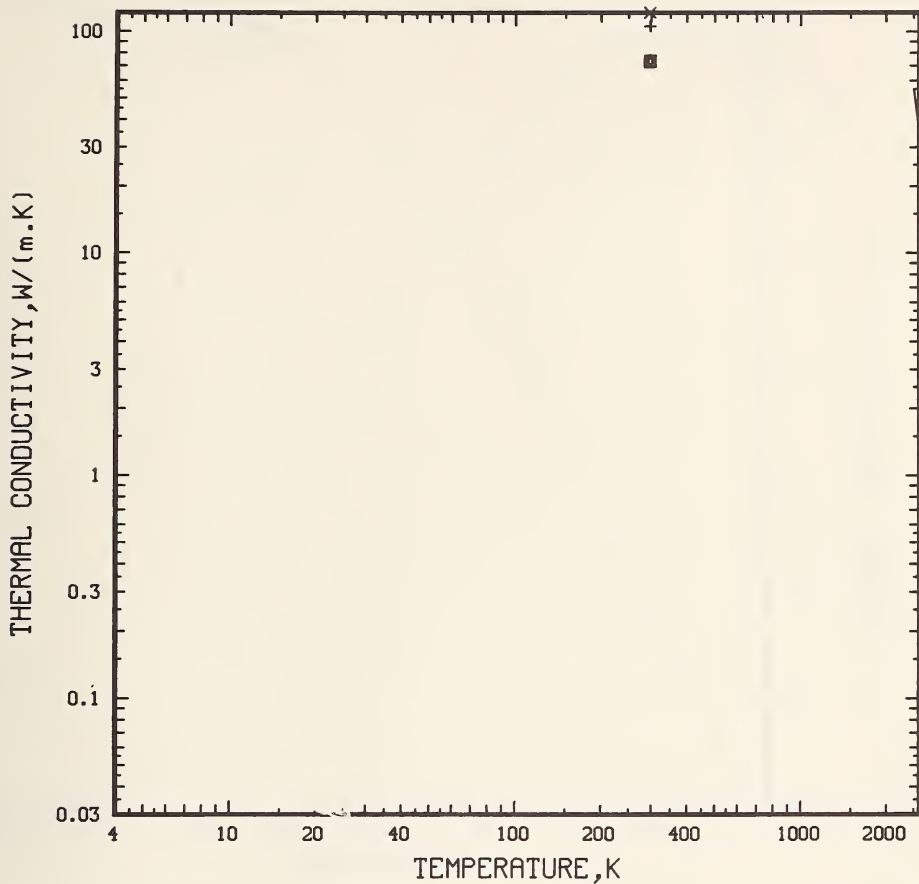

Figure 34. Thermal conductivity data from Hust (7) on seven AXM-5Q1 graphite specimens at 296 K.

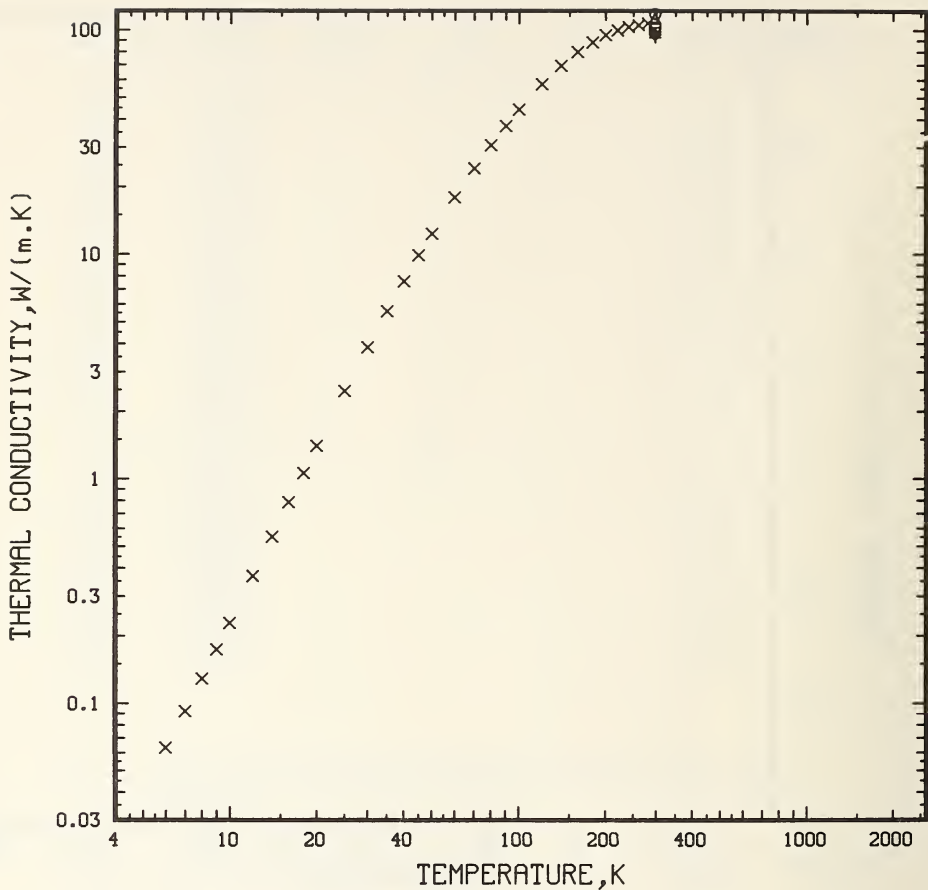

Figure 35. Thermal conductivity data from Hust (7) on seven AXM-5Q1 graphite specimens, six at 296 K and one specimen from 6 to 300 K.



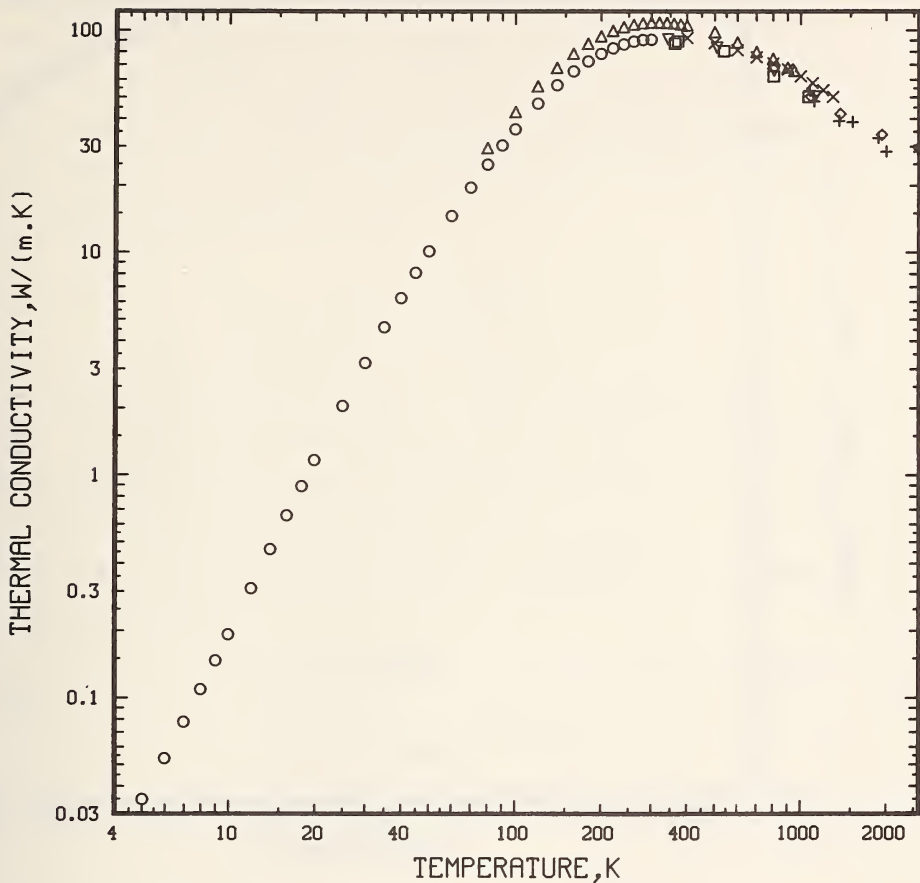

Figure 36. Thermal conductivity data for seven AXM-5Q1 graphite specimens from the following participants at temperatures from 5 to 2600 K:

- - HUST(7)
- △ - MOORE(11)
- - PARTICIPANT 5
- ▽ - PARTICIPANT 5
- ◇ - PARTICIPANT 5
- + - PARTICIPANT 5
- × - PARTICIPANT 3

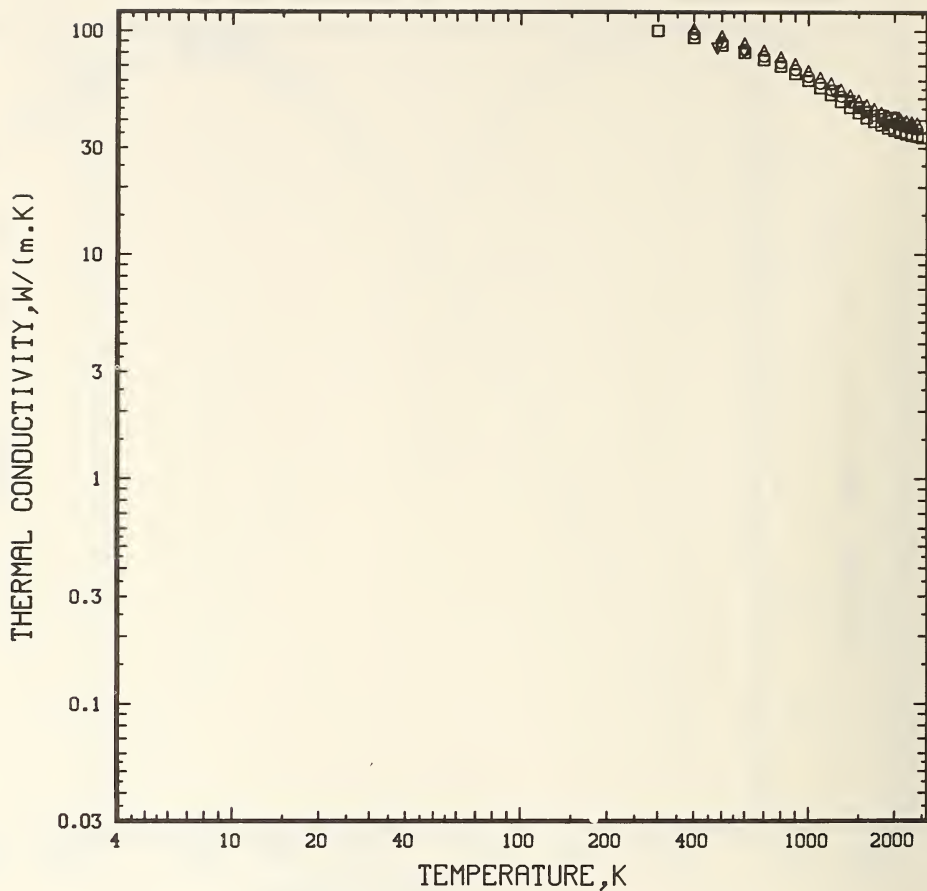

Figure 37. Thermal conductivity data for four AXM-5Q1 graphite specimens from the following participants at temperatures from 300 to 2600 K:

- - TAYLOR(12)
- △ - TAYLOR(12)
- - TAYLOR(12)
- ▽ - TAYLOR(13)

temperature range as was the case at room temperature in Phase II. Numerous equations were tried to represent the general temperature dependence of these thermal conductivity data. Because of the relatively large differences between data sets, especially at high temperatures, an equation with a large number of coefficients was undesirable. The base equation finally selected to represent the general behavior of these data is

$$\lambda_b = G_1 T^{G_2} / (1 + G_3 T^{G_4})^{G_5} \quad (5.1.1)$$

This equation was modified in two ways to obtain the best representation of the data. First, the equation was modified according to the correlation between  $L$  and  $\rho$  described in Phase II which is equivalent to the multiplier  $M_1$ . Second, it was modified by a multiplier function,  $M_2$  to remove most of the remaining oscillatory systematic deviations. The final representation of the thermal conductivity data is

$$\lambda = \lambda_b M_1 M_2 \quad (5.1.2)$$

where

$$M_1 = (-18.51 + 0.01908 d_0) \times 10^{-6} / \rho_0 \quad (5.1.3)$$

$$M_2 = 1 + 0.0012 \ln(T/5.4) \ln(T/15) \ln(T/58) \ln(T/180) \ln(T/1000) \ln(T/1700) \quad (5.1.4)$$

$T$  = temperature in K,  $\lambda$  is in  $W \cdot m^{-1} \cdot K$ ,  $d_0$  is room temperature density in  $Kg/m^3$  and  $\rho_0$  is electrical resistivity in  $\Omega \cdot m$ , and the parameters are

$$G_1 = 0.000537 \quad G_2 = 2.589 \quad G_3 = 0.000202 \quad G_4 = 1.678 \quad G_5 = 2.02$$

Figures 38 through 41 show the deviations of the observed thermal conductivity data from eq. (5.1.2). For convenience of comparison, Figures 42-44 contain all of the data on each plot. Figure 42 is a composite of Figures 38-41. Figure 43 shows the deviations of all the data from eq. (5.1.2) with  $M_1 = 1$

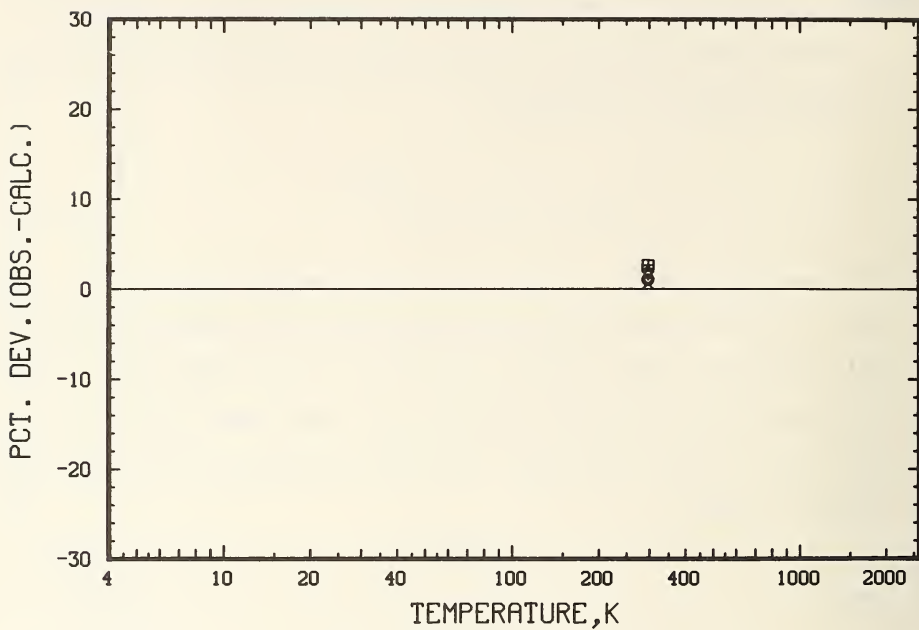

Figure 38. Thermal conductivity deviations for seven AXM-5Q1 graphite specimens as reported by Hust (7) from eq. (5.1.2) at 296 K.

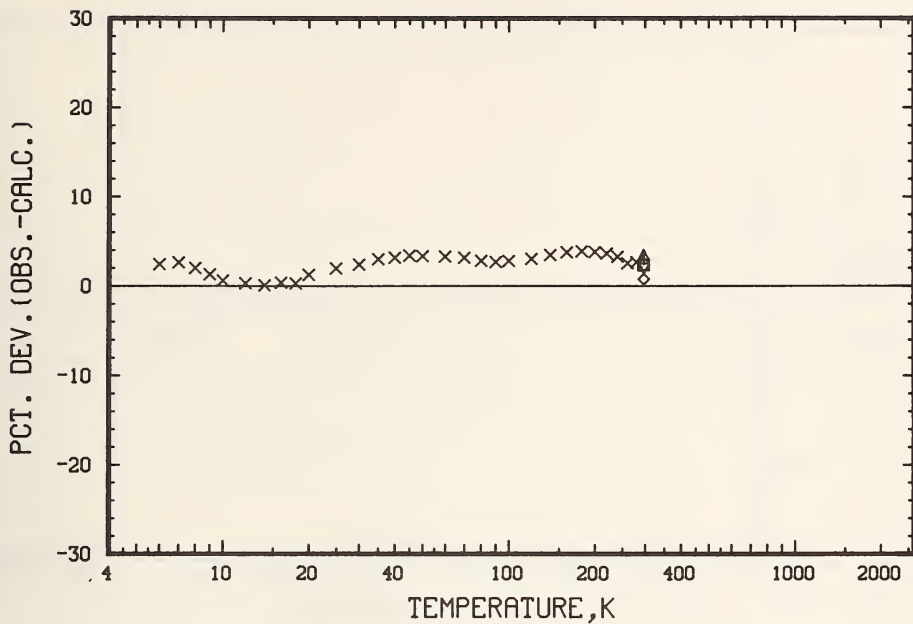

Figure 39. Thermal conductivity deviations for seven AXM-5Q1 graphite specimens as reported by Hust (7) from eq. (5.1.2), six at 296 K and one at temperatures from 6 to 300 K.

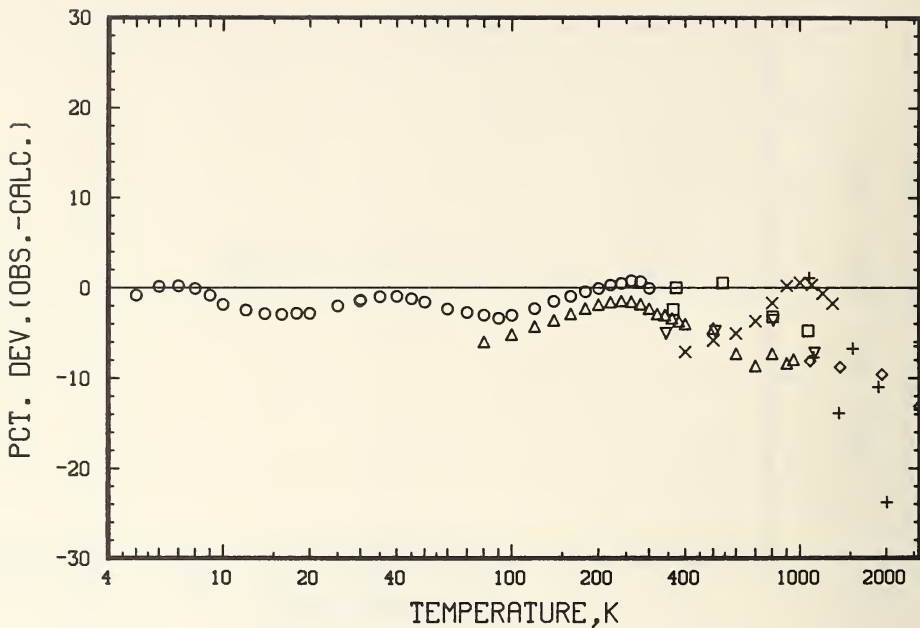

Figure 40. Thermal conductivity deviations for seven AXM-5Q1 graphite specimens as reported by the following participants from eq. (5.1.2) at temperatures from 5 to 2600 K:

- |                   |                   |
|-------------------|-------------------|
| ○ - HUST(7)       | ◇ - PARTICIPANT 5 |
| △ - MOORE(11)     | + - PARTICIPANT 5 |
| □ - PARTICIPANT 5 | × - PARTICIPANT 3 |
| ▽ - PARTICIPANT 5 |                   |

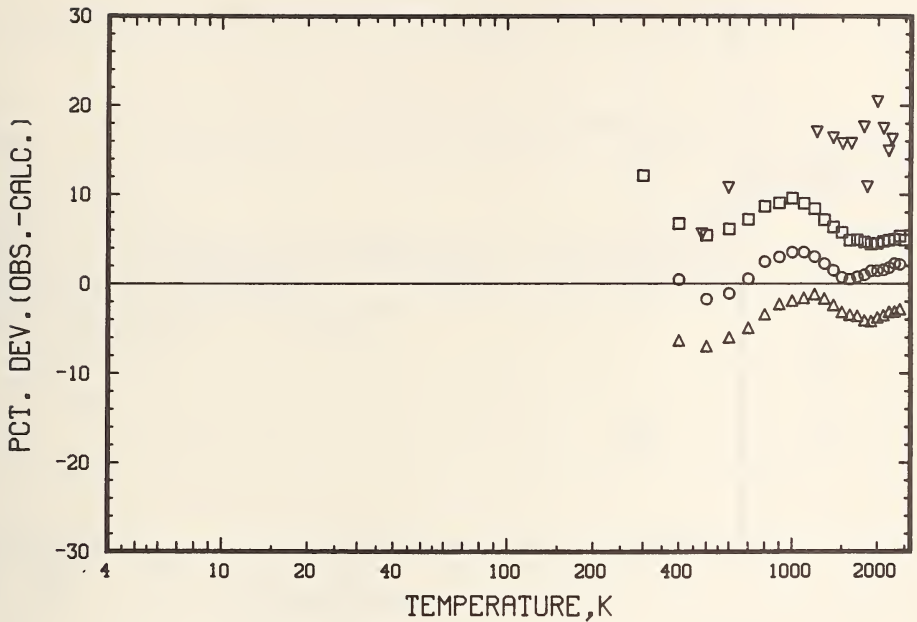

Figure 41. Thermal conductivity deviations for four AXM-5Q1 graphite specimens as reported by the following participants from eq. (5.1.2) at temperatures from 300 to 2600 K:

- - TAYLOR(12)
- △ - TAYLOR(12)
- - TAYLOR(12)
- ▽ - TAYLOR(13)



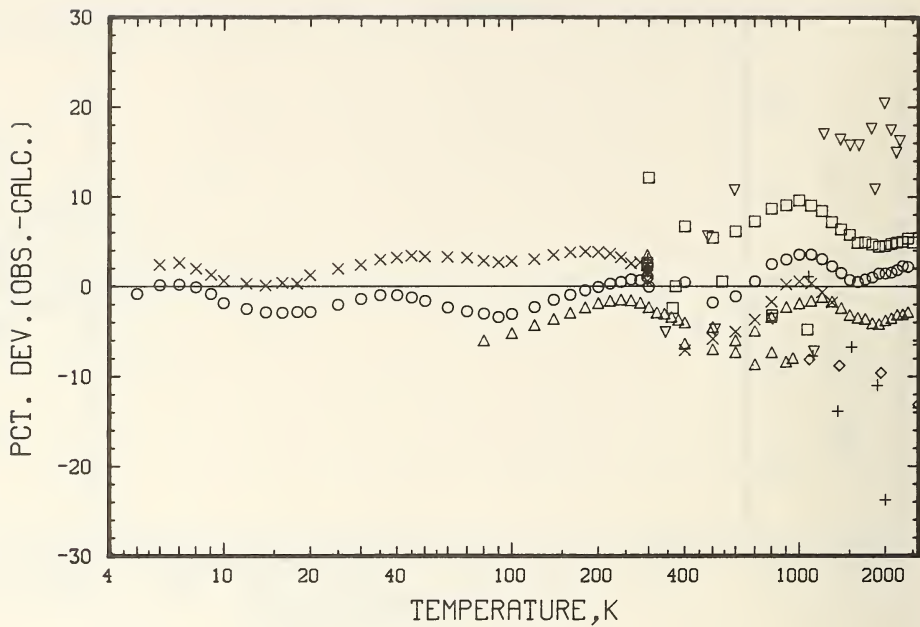

Figure 42. Thermal conductivity deviations of all AXM-5Q1 graphite data from eq. (5.1.2). Composite of Figures 38-41.

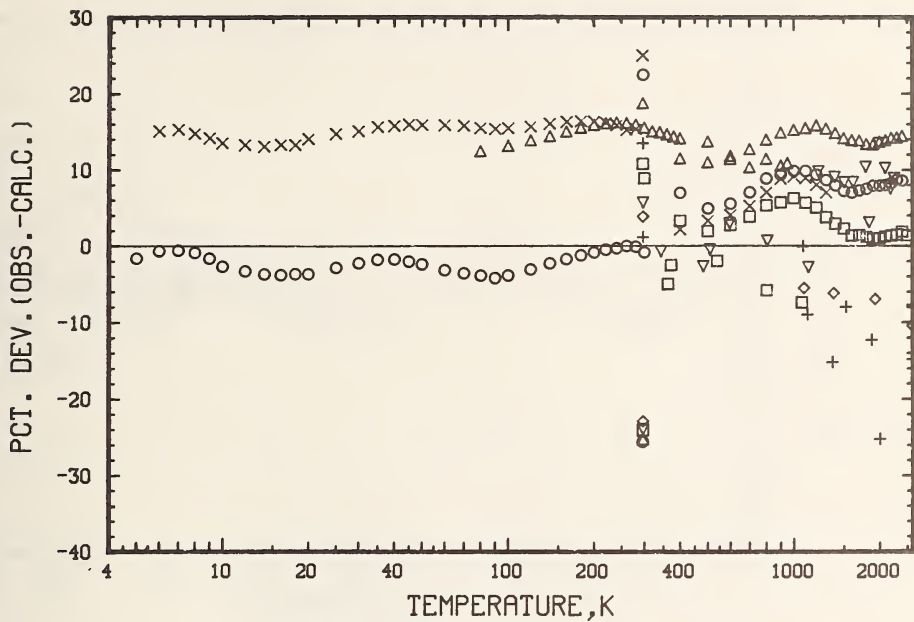

Figure 43. Thermal conductivity deviations of all AXM-5Q1 graphite data from eq. (5.1.2) with  $M_1 = 1$ .

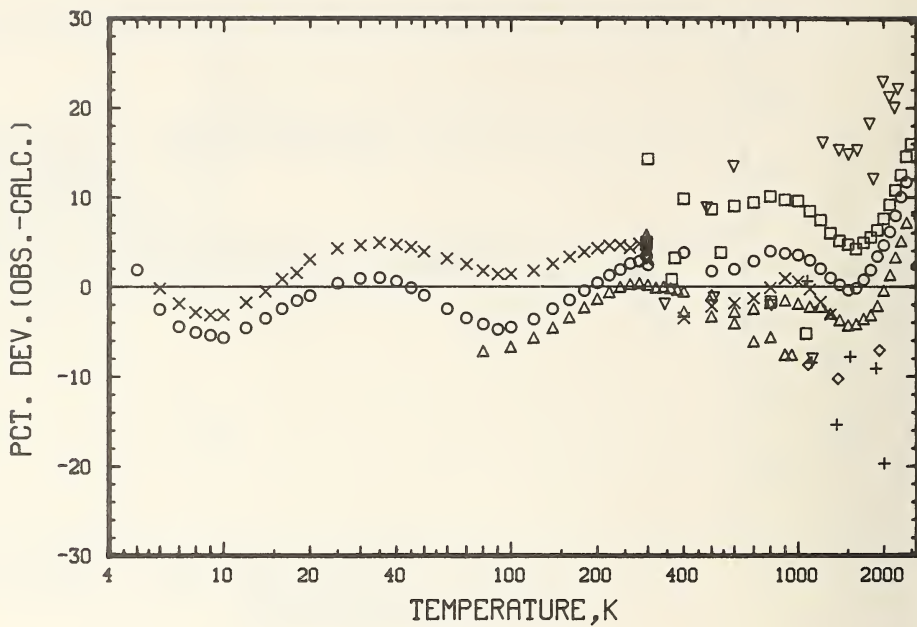

Figure 44. Thermal conductivity deviations of all AXM-501 graphite data from eq. (5.1.2) with  $M_2 = 1$ .

(i.e., no corrections for room temperature differences in density and electrical resistivity). Figure 44 shows the deviations of all data from eq. (5.1.2) with  $M_2 = 1$  (i.e., no corrections for the residual oscillations). It is clear from these plots that the corrections for the room temperature characteristic differences are essential. However, relatively large scatter still exists at the higher temperatures. This scatter between data sets may be caused by a) experimental error and b) if the L vs d correlation found at room temperature is also a function of temperature. The data of Hust (7) on two specimens measured from 5 to 300 K suggests that the correlation is quite good to the lowest temperature measured. The data of Taylor (12) on three specimens, and the data of participant 5 on four specimens suggest that the correlation is not as good at higher temperatures.

Based on this research, it is concluded that this graphite can be a useful thermal conductivity standard with the following limitations:

- a) Only those rods should be selected that show the smallest electrical resistivity vs position dependence.
- b) The actual specimen used should be characterized for room temperature electrical resistivity and density values.
- c) Specimens with room temperature electrical resistivities outside the range 13.0 to 15.0  $\mu\Omega\cdot\text{m}$  and densities outside the range 1.70 to 1.75  $\text{g}/\text{cm}^3$  should be excluded.
- d) The uncertainty of eq. (5.1.2) at high temperatures is as high as 10%.

Table 20 contains recommended values of  $\lambda$  for temperatures from 5 to 2600 K as given by eq. (5.1.2) with  $\rho_0 = 14.5 \mu\Omega\cdot\text{m}$  and  $d_0 = 1.73 \text{ g}/\text{cm}^3$ . It is noted that the correction for  $\rho_0$  and  $d_0$  is zero at that point, i.e.,  $M_1 = 1$ .

Table 20. Thermophysical properties of AXM-5Q1 graphite as calculated from the equations indicated in this report, for room temperature electrical resistivity =  $14.5 \mu\Omega\cdot\text{m}$  and density =  $1730 \text{ kg/m}^3$ .

TEMPERATURE (K)	THERMAL CONDUCTIVITY ( $\text{W}\cdot\text{m}^{-1}\cdot\text{K}^{-1}$ )	ELECTRICAL RESISTIVITY ( $\mu\Omega\cdot\text{m}$ )	SPECIFIC HEAT ( $\text{J}\cdot\text{kg}^{-1}\cdot\text{K}^{-1}$ )	THERMAL DIFFUSIVITY ( $\mu\text{m}^2\cdot\text{s}^{-1}$ )	THERMAL EXPANSION (%)
5	.0354	28.78			-.198
6	.0537	28.73			-.197
7	.0783	28.67			-.196
8	.1099	28.62			-.196
9	.1494	28.55			-.195
10	.1971	28.48			-.194
15	.573	28.11			-.191
20	1.201	27.71			-.188
25	2.095	27.28			-.184
30	3.255	26.85			-.181
35	4.675	26.43			-.178
40	6.33	26.00			-.174
45	8.23	25.59			-.171
50	10.32	25.19			-.168
55	12.59	24.79			-.164
60	15.03	24.41			-.161
65	17.59	24.04			-.158
70	20.25	23.68			-.154
75	23.00	23.33			-.151
80	25.81	22.98			-.148
85	28.65	22.65			-.144
90	31.51	22.33			-.141
95	34.37	22.02			-.137
100	37.21	21.72			-.134
120	48.16	20.60			-.120
140	57.9	19.60			-.107
160	66.4	18.71			-.093
180	73.3	17.92			-.079
200	78.9	17.20			-.065
220	83.2	16.55			-.051
240	86.4	15.97			-.037
260	88.8	15.44			-.023
280	90.4	14.96			-.009
300	91.3	14.52			.005
400	90.2	12.83	995	52.52	.078
500	84.6	11.74	1208	40.67	.152
600	78.0	11.03	1381	32.90	.228
700	71.7	10.58	1518	27.54	.306
800	65.9	10.30	1629	23.67	.386
900	60.9	10.15	1718	20.78	.468
1000	56.5	10.10	1790	18.55	.551
1100	52.7	10.12	1849	16.80	.636
1200	49.48	10.19	1898	15.39	.723
1300	46.68	10.29	1939	14.26	.811
1400	44.28	10.43	1973	13.32	.901
1500	42.22	10.58	2002	12.56	.993
1600	40.46	10.76	2027	11.92	1.08
1700	38.95	10.94	2048	11.39	1.18
1800	37.67	11.14	2066	10.95	1.27
1900	36.58	11.34	2082	10.58	1.37
2000	35.66	11.55	1096	10.28	1.47
2100	34.89	11.75	2108	10.03	1.57
2200	34.25	11.96	2118	9.82	1.67
2300	33.72	12.17	2128	9.66	1.78
2400	33.29	12.38	2136	9.53	1.88
2500	32.96	12.59	2143	9.43	1.99

The uncertainty of the  $\lambda$  values in Table 20 is estimated to be  $\pm 2\%$  at temperatures below 300 K. At higher temperatures, the uncertainty increases to  $\pm 10\%$  at 2600 K.

## 5.2 Electrical Resistivity

Figures 45 through 47 show the electrical resistivity data from Tables 6 through 19. Based upon the abnormal behavior of the electrical resistivity data from Table 15, i.e., the results reported by participant 2, (see Figure 47) this data set was excluded from the following comparisons. It is noted that this specimen had an abnormally high room temperature electrical resistivity and is the basis for the previous restriction on the range of valid thermal conductivities. Again, an equation with relatively few coefficients was desired to represent the general temperature behavior of the data. The equation selected is

$$\rho = G_1 - G_2 \text{Exp}(-(\ln(T/G_3)/G_4)^2) \quad (5.2.1)$$

This equation was modified to account for the room temperature differences, and the resulting final equations is

$$\rho = G_1 - G_2 \text{Exp}(-(\ln(T/G_3)/G_4)^2) + \rho_0 - 14.5 \quad (5.2.2)$$

where  $\rho$  = electrical resistivity in  $\mu\Omega\cdot\text{m}$ , at temperature,  $T$ , in K and  $\rho_0$  = the room temperature resistivity of the specimen in  $\mu\Omega\cdot\text{m}$ . The least squares values of the coefficients are  $G_1 = 28.9$ ,  $G_2 = 18.8$ ,  $G_3 = 1023$ , and  $G_4 = 2.37$ . Although some systematic differences are apparent in the following deviation plots, no further modification seemed justified because of the larger scatter between data sets.

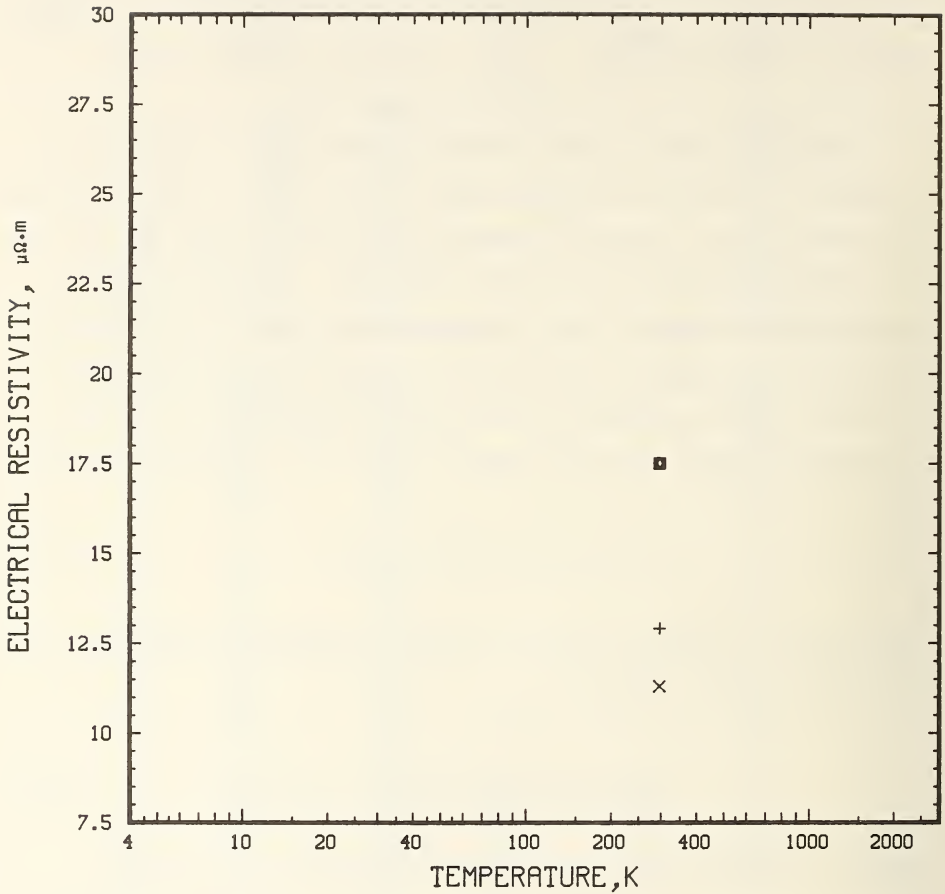

Figure 45. Electrical resistivity data from Hust (7) on seven AXM-501 graphite specimens at 296 K.



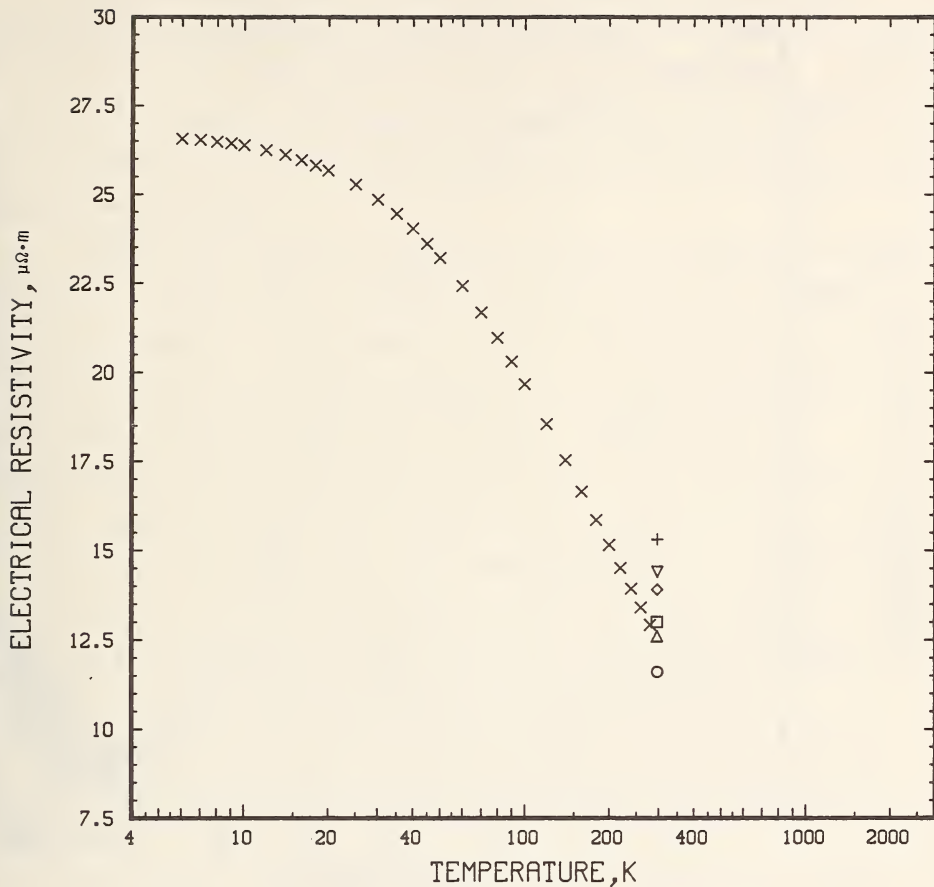

Figure 46. Electrical resistivity data from Hust (7) on seven AXM-5Q1 graphite specimens, six at 296 K and one specimen from 6 to 300 K.

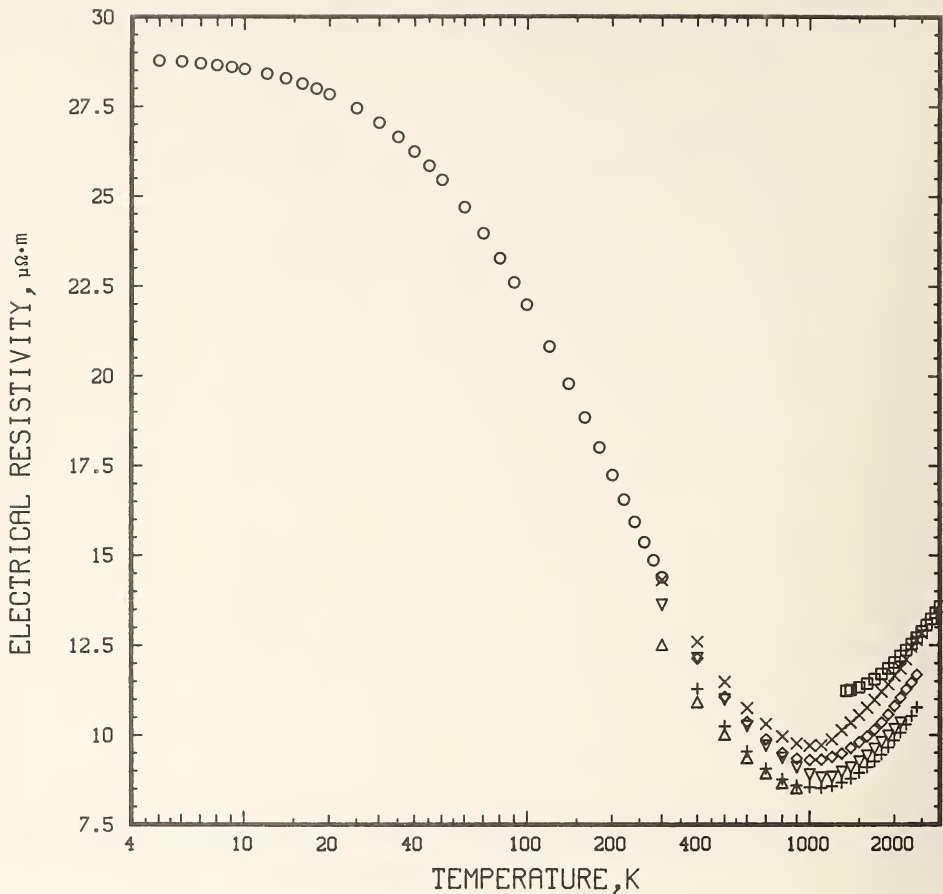

Figure 47. Electrical resistivity data for seven AXM-5Q1 graphite specimens from the following participants from 5 to 2900 K:

- |                   |                |
|-------------------|----------------|
| ○ - HUST(7)       | ◇ - TAYLOR(12) |
| △ - MOORE(11)     | + - TAYLOR(12) |
| □ - PARTICIPANT 2 | × - TAYLOR(12) |
| ▽ - PARTICIPANT 3 |                |

Figures 48 through 50 show the deviations of the experimental data from eq. (5.2.2). For convenience of comparison, these data are all shown on a single graph in Figure 51. Figure 52 shows the deviations of the data from eq. (5.2.1) which is uncorrected for room temperature differences. It is clear that most of the differences at high and low temperatures are accounted for simply by the room temperature differences.

A comment about the data of participant 2 (the data set excluded earlier) is in order. It appears that for an unknown reason the value of  $\rho_0$  is incorrect for this specimen. The actual specimen used was in the form of a thin hollow cylinder. The rod from which it was machined was measured at NBS and by the participant. These  $\rho_0$  values agreed to within 2%. The participant also measured the  $\rho_0$  of the hollow cylinder and obtained a value only slightly higher. However, the deviations of the data from participant 2 from eq. (5.2.2) are near -30% at all temperatures. This difference can be nearly eliminated if a value of  $15.2 \mu\Omega\cdot\text{m}$  is used for  $\rho_0$  instead of  $18.81 \mu\Omega\cdot\text{m}$ . Using a value of  $15.2 \mu\Omega\cdot\text{m}$  yields deviations of 1.5% at 1350 K, and -4.0% at 2900 K, varying smoothly and nearly linearly at temperatures between these extremes.

Based on this research, it is concluded that this graphite can be a useful electrical resistivity standard with the same limitations given in the previous section.

Table 20 contains recommended values of electrical resistivity for temperatures from 5 to 2500 K as given by eq. (5.2.2) with  $\rho_0 = 14.5 \mu\Omega\cdot\text{m}$ .

### 5.3 Specific Heat

Figure 53 shows the specific heat data from Tables 6 through 19.

The high temperature data of participants 1 and 2 and Taylor (12) are in reasonable agreement. However, the low temperature data of Isaacs is not only

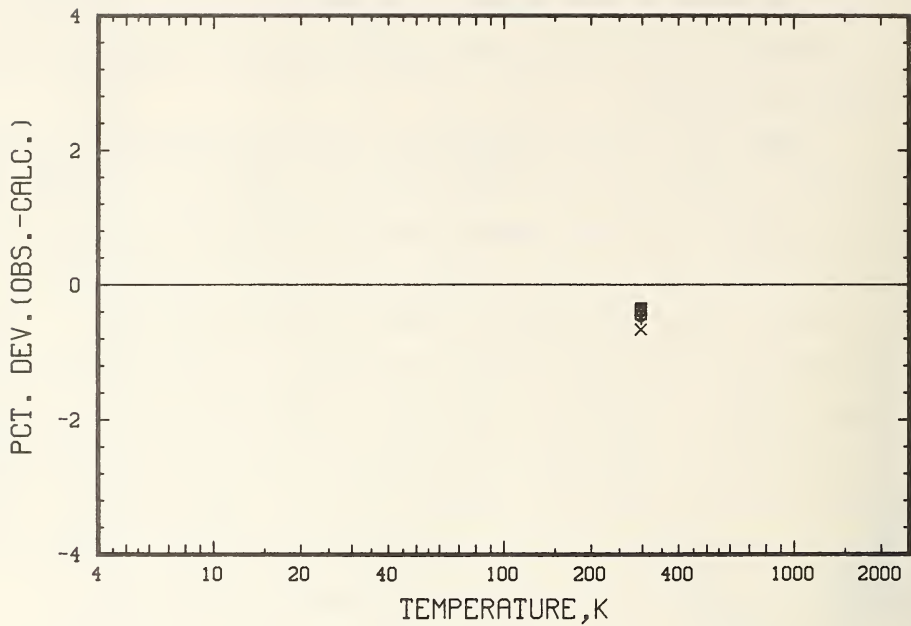

Figure 48. Electrical resistivity deviations for seven AXM-5Q1 graphite specimens as reported by Hust (7) from eq. (5.2.2) at 296 K.

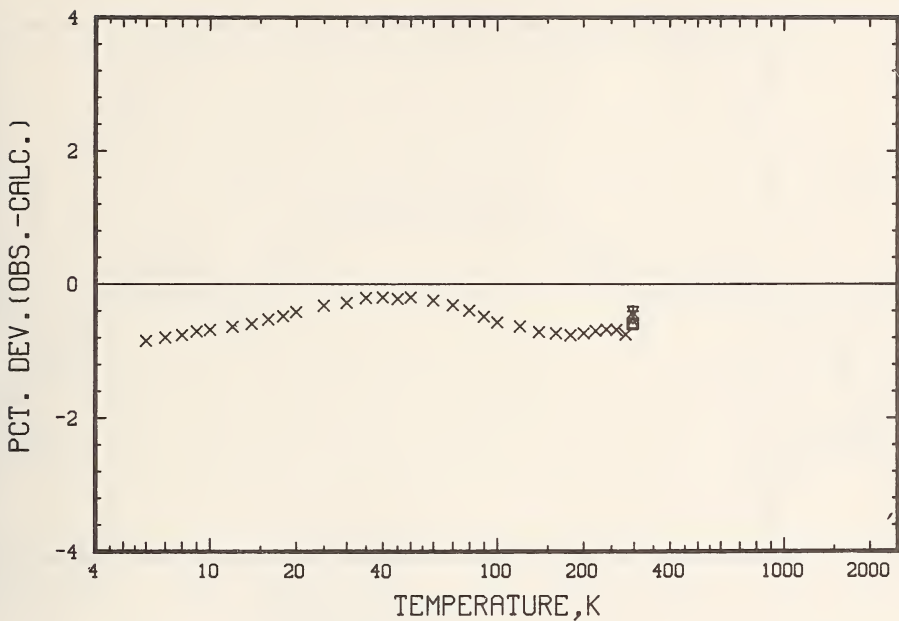

Figure 49. Electrical resistivity deviations for seven AXM-5Q1 graphite specimens as reported by Hust (7) from eq. (5.2.2), six at 296 K and one at temperatures from 6 to 300 K.

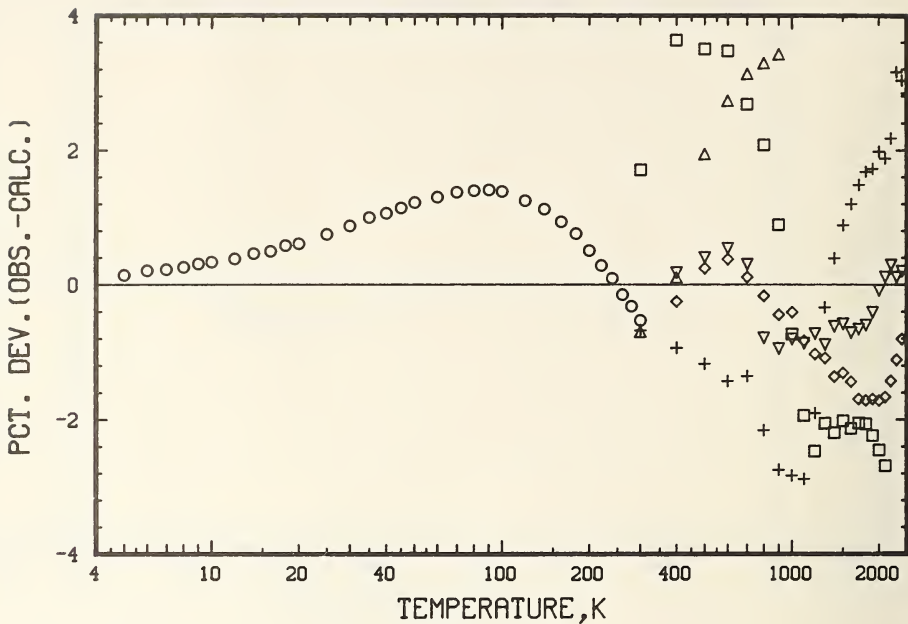

Figure 50. Electrical resistivity deviations for six AXM-5Q1 graphite specimens as reported by the following participants from eq. (5.2.2) at temperatures from 5 to 2500 K.

- |                   |                |
|-------------------|----------------|
| ○ - MUST(7)       | ▽ - TAYLOR(12) |
| △ - MOORE(11)     | ◇ - TAYLOR(12) |
| □ - PARTICIPANT 3 | + - TAYLOR(12) |

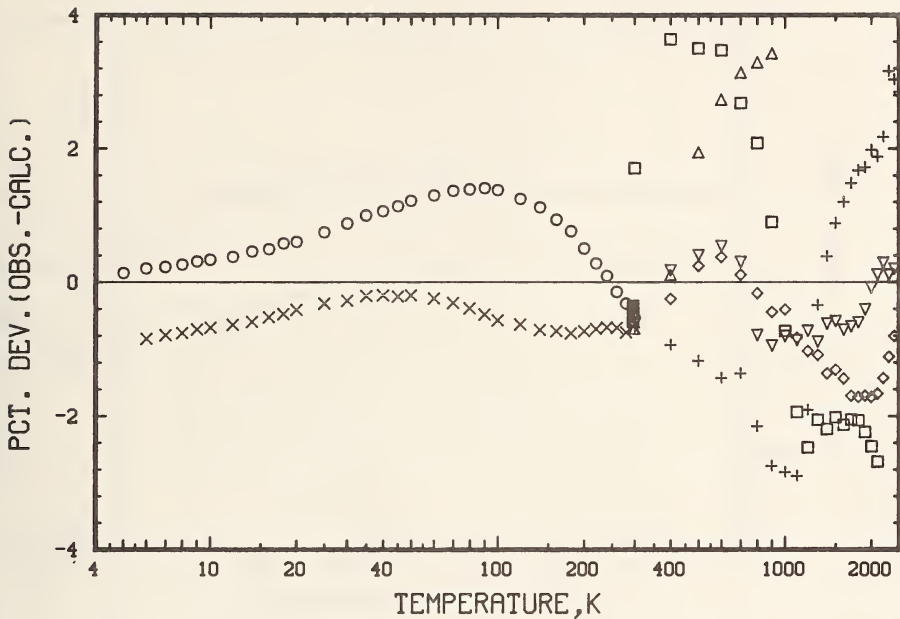

Figure 51. Electrical resistivity deviations of all (excluding participant 2) AXM-5Q1 graphite data from eq. (5.2.2). Composite of Figures 48-50.



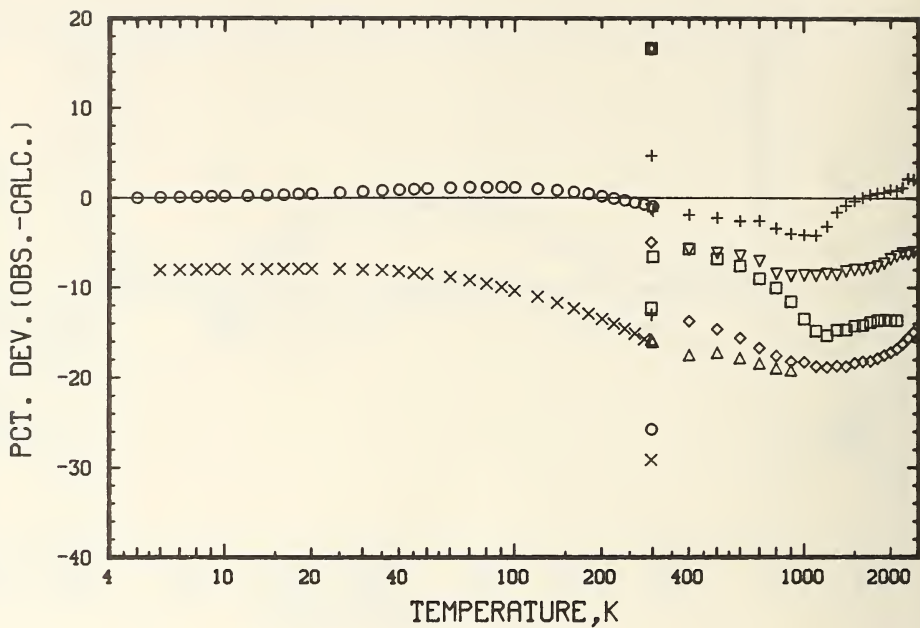

Figure 52. Electrical resistivity deviations of all AXM-5Q1 graphite data from eq. (5.2.2) without the correction for room temperature differences.

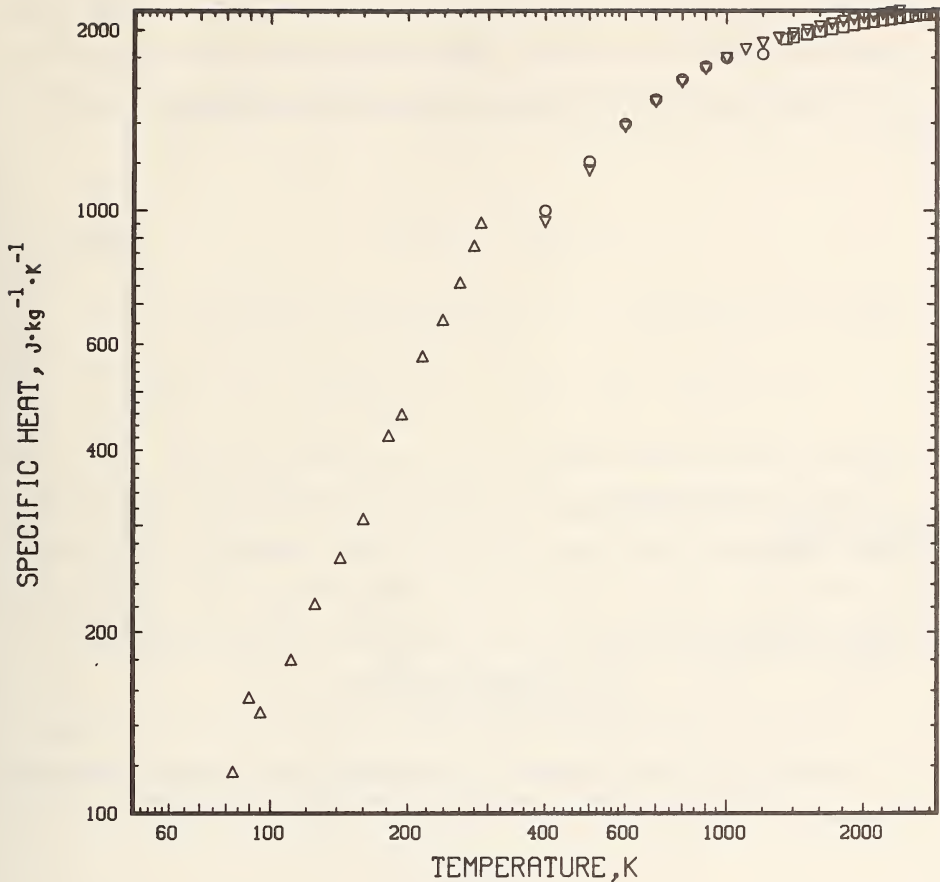

Figure 53. Specific heat data for four AXM-5Q1 graphite specimens from the following participants at temperatures from 80 to 2900 K:

- - PARTICIPANT 1
- △ - ISAACS(8)
- - PARTICIPANT 2
- ▽ - TAYLOR(12)

abnormal for expected specific heat behavior, but also clearly discordant with the other three data sets. With this in mind and the recognition that the lowest temperature values may be in error, Isaacs data were given a low weight in fitting an equation to the entire data base. The equation selected for this purpose is

$$C = (G_1 T^{-G_2} + G_3 T^{G_4})^{-1} \quad (5.3.1)$$

where C is in  $J \cdot kg^{-1} \cdot K^{-1}$ , T is in K and the parameters obtained are

$$G_1 = 11.07 \quad G_2 = 1.644 \quad G_3 = 0.0003688 \quad G_4 = 0.02191$$

The deviations of the data from eq. (5.3.1) are shown in Figure 54.

Because of the limited specific heat data and the discordance between data sets, recommended values are not given at this time. Research on specific heat of graphite is continuing. Table 20 lists values of specific heat as calculated from eq. (5.3.1)

#### 5.4 Thermal Diffusivity

Figures 55 and 56 show the thermal diffusivity data from Tables 6 through 19. Equation (5.4.1), the definition of diffusivity, was selected to represent the temperature dependence of these data.

$$D = \lambda / C d \quad (5.4.1)$$

where  $\lambda$  is given by eq. (5.2.1), C is given by eq. (5.3.1) and  $d = d_0 / (1 + \Delta L / L)^3$ .

Figures 57 and 58 show the deviation of the experimental data from eq. (5.4.1). Figures 59 and 60 show the deviations without the corrections for room temperature differences.

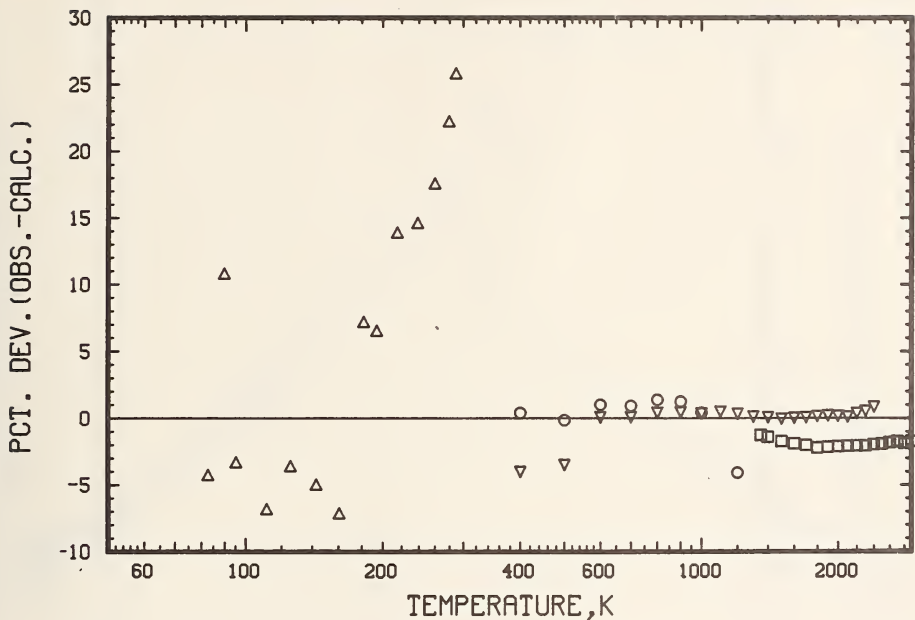

Figure 54. Specific heat deviations for four AXM-5Q1 graphite specimens as reported by the following participants from eq. (5.3.1) at temperatures from 80 to 2900 K:

- - PARTICIPANT 1
- △ - ISACS(8)
- - PARTICIPANT 2
- ▽ - TAYLOR(12)

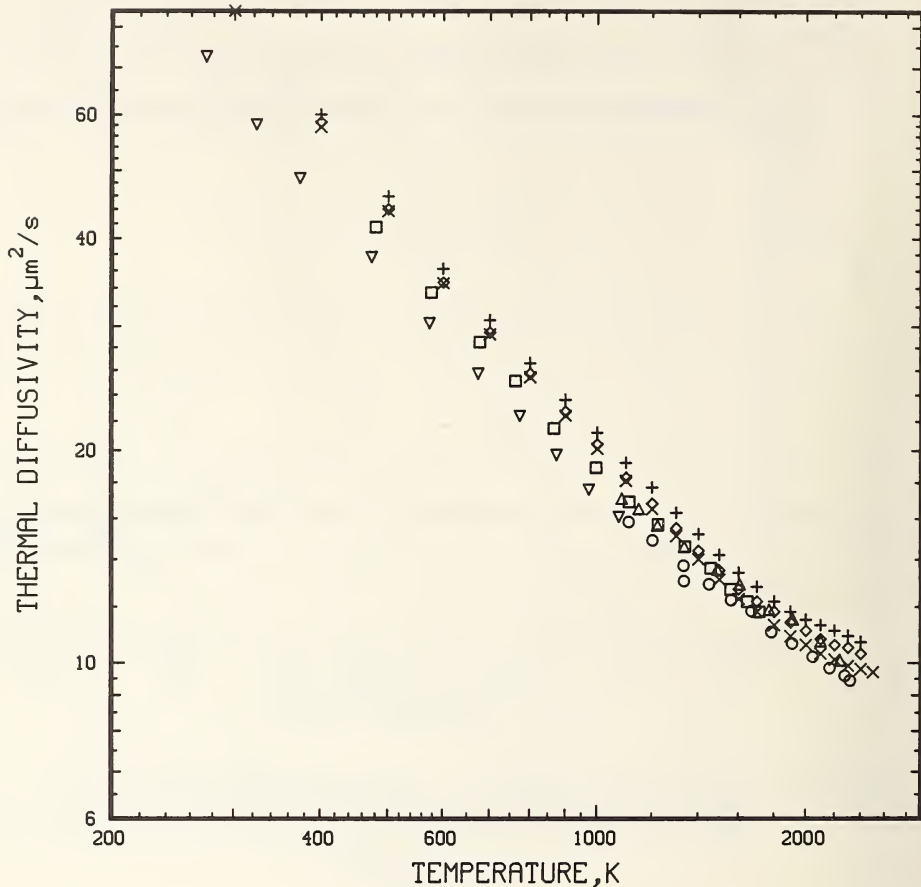

Figure 55. Thermal diffusivity data for seven AXM-5Q1 graphite specimens from the following participants from 280 to 2600 K:

- |                   |                |
|-------------------|----------------|
| ○ - BRANDT(6)     | ◇ - TAYLOR(12) |
| △ - BRANDT(6)     | + - TAYLOR(12) |
| □ - MAGLIC(9)     | × - TAYLOR(12) |
| ▽ - MIRKOVICH(10) |                |

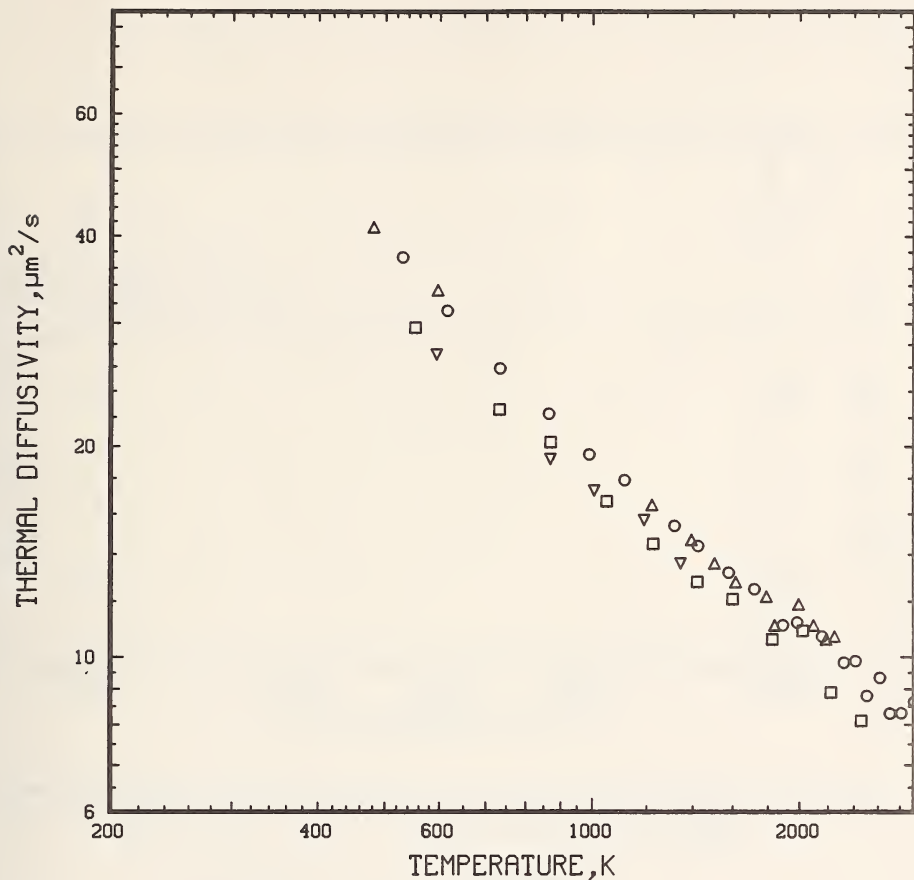

Figure 56. Thermal diffusivity data for four AXM-5Q1 graphite specimens from the following participants from 480 to 2900 K:

- O - TAYLOR(13)
- Δ - TAYLOR(13)
- - PARTICIPANT 4
- ▽ - PARTICIPANT 4

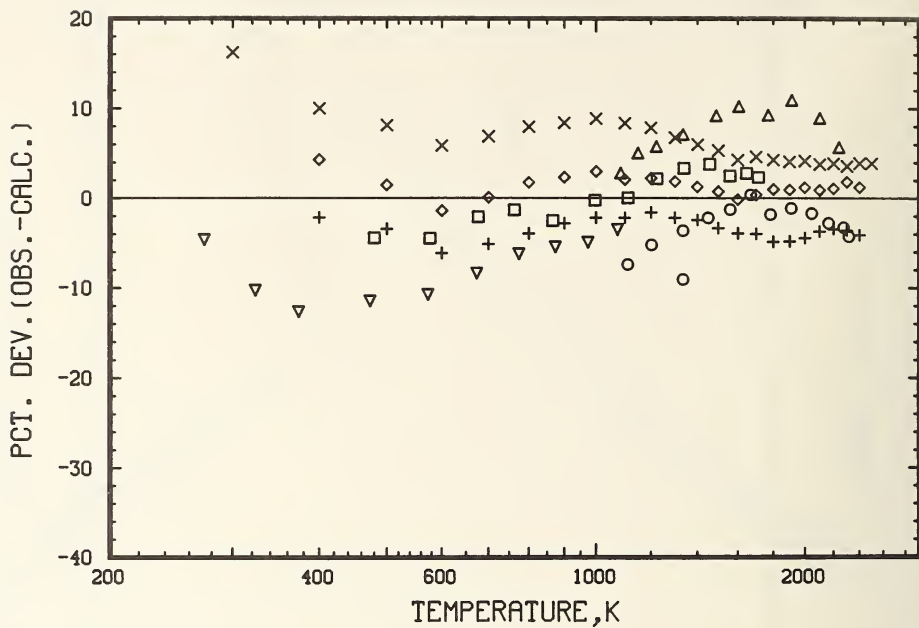

Figure 57. Thermal diffusivity deviations for seven AXM-5Q1 graphite specimens as reported by the following participants from eq. (5.4.1) at temperatures from 280 to 2600 K:

- |                   |                |
|-------------------|----------------|
| ○ - BRANDT(6)     | ◇ - TAYLOR(12) |
| △ - BRANDT(6)     | + - TAYLOR(12) |
| □ - MAGLIC(9)     | × - TAYLOR(12) |
| ▽ - MIRKOVICH(10) |                |

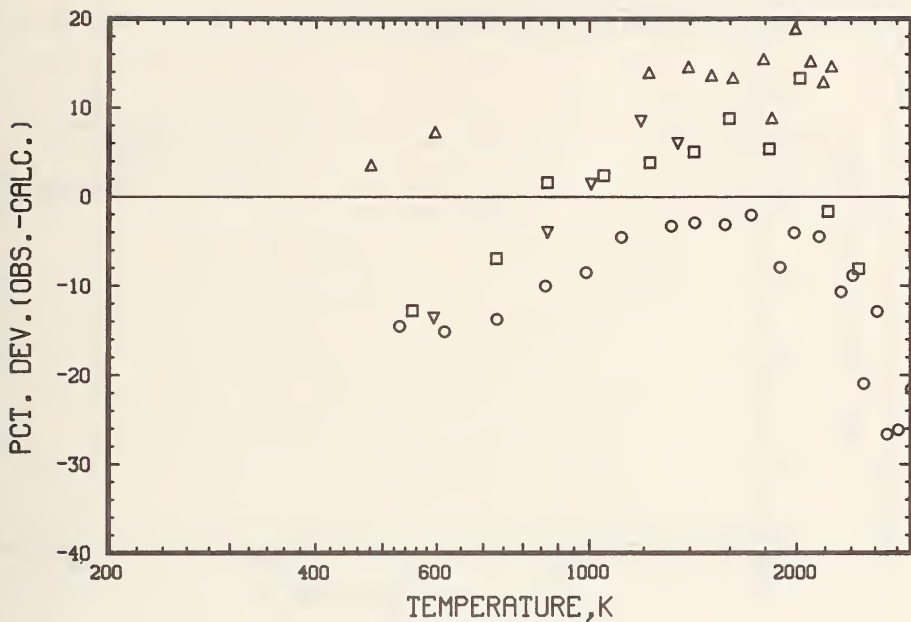

Figure 58. Thermal diffusivity deviations for four AXM-5Q1 graphite specimens as from the following participants from eq. (5.4.1) at temperatures from 480 to 2900 K:

- - TAYLOR(13)
- △ - TAYLOR(13)
- - PARTICIPANT 4
- ▽ - PARTICIPANT 4



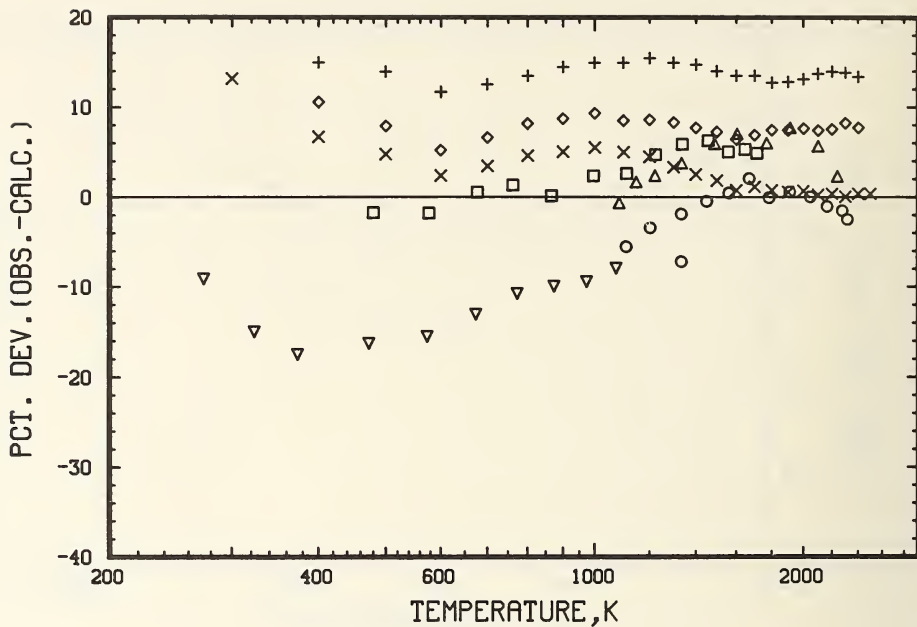

Figure 59. Thermal diffusivity deviations for seven AXM-501 graphite specimens as from the following participants from eq. (5.4.1) (without corrections for room temperature differences) at temperatures from 280 to 2600 K:

- |                   |                |
|-------------------|----------------|
| ○ - BRANDT(6)     | ◇ - TAYLOR(12) |
| △ - BRANDT(6)     | + - TAYLOR(12) |
| □ - MAGLIC(9)     | × - TAYLOR(12) |
| ▽ - MIRKOVICH(10) |                |

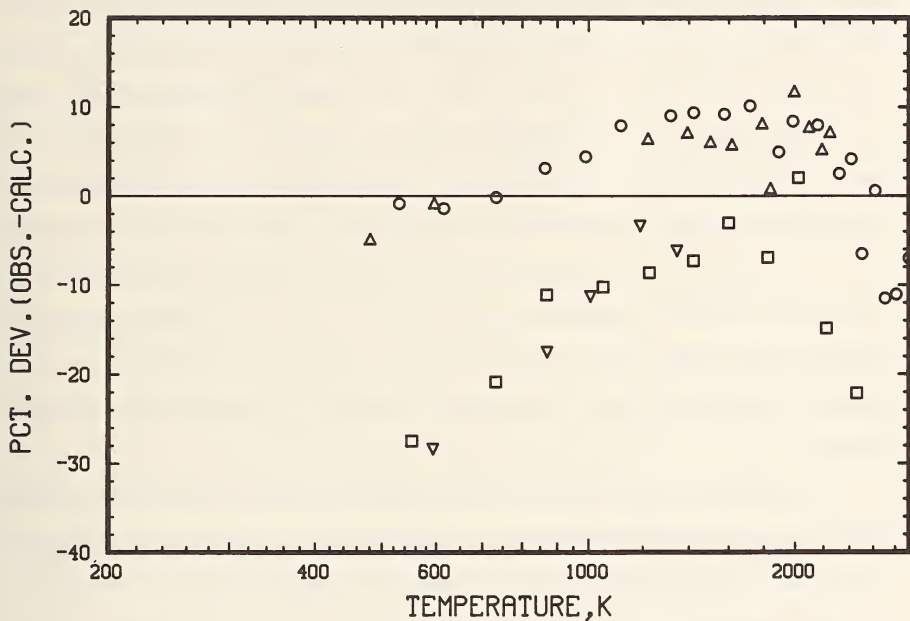

Figure 60. Thermal diffusivity deviations for four AXM-5Q1 graphite specimens as from the following participants from eq. (5.4.1) (without corrections for room temperature differences) at temperatures from 480 to 2900 K:

- - TAYLOR(13)
- △ - TAYLOR(13)
- - PARTICIPANT 4
- ▽ - PARTICIPANT 4

These deviation plots indicate, first, that an independent equation for diffusivity is not necessary at this time and, second, that the deviations between the participants are about that expected from previously reported experimental uncertainties of such measurements. In addition, the difference in the spread of data is not reduced appreciably through the application of the room temperature correlation. The reason for this is not clear but the following should be noted: a) thermal diffusivity data from other studies are typically spread by about  $\pm 10\%$  and b) thermal diffusivity specimens are frequently very small, making accurate electrical resistivity characterization difficult. The latter point should not contribute significantly however, because the bulk specimens were characterized and highly localized inhomogeneities should not be this large. It is concluded therefore that most of this spread is caused by experimental variability. The excellent agreement of eq. (5.4.1) with the mean of all the data is very encouraging.

A recommendation for use of this graphite as a thermal diffusivity standard will be given further consideration. Table 20 lists values of thermal diffusivity as calculated from eq. (5.4.1) with  $\rho_0 = 14.5 \mu\Omega \cdot m$  and  $d_0 = 1730 \text{ Kg/m}^3$  from 400 to 2500 K.

### 5.5 Thermal Expansion

No thermal expansion data per se were reported in this study. However, the density data reported by Taylor (12) were actually obtained from thermal expansion measurements. These data were analyzed by comparing them to

$$d = d_0 / (1 + \Delta L/L)^3 \quad (5.5.1)$$

where  $\Delta L/L$  values were computed from the equation

$$\Delta L/L = -0.201 + 6.595 \times 10^{-4}T + 9.593 \times 10^{-8}T^2 - 3.427 \times 10^{-12}T^3 \quad (5.5.2)$$

Eq. (5.5.2) was obtained from Touloukian, et al. (14). The density deviations obtained are illustrated in Figure 61. It is noted that excellent agreement is obtained. The fact that the deviations for each specimen are nearly parallel to the zero line indicate that the thermal expansion data of Taylor (12) are in good agreement with eq. (5.5.2). Values of thermal expansion as calculated from eq. (5.5.2) are listed in Table 20.

#### 5.6 Seebeck Coefficient

Figure 62 shows the Seebeck coefficient data from Tables 6 through 19. No representation of these data was undertaken. Until an interest is expressed in this property as an SRM, no further work is planned.

#### 6. ACKNOWLEDGMENTS

I acknowledge the assistance, suggestions, and encouragement of several associates involved in this program. In particular, I thank Greg Ruff, Susan Fiske, Kevin Kayse, and Bruce Howrey of this laboratory for the numerous measurements and data analysis they have performed. My appreciation is given to Peyton Moore and his associates at ORNL for advice and assistance on the construction of the ambient-temperature comparative thermal conductivity apparatus. The continued support, encouragement, and suggestions of M. Minges (AFML) and R. E. Michaelis and R. K. Kirby (NBS, OSRM) is also acknowledged. The interest and cooperation of Wayne Fagen of POCO Graphite, Inc. has helped to assure the success of this program. The efforts of each of the cooperative participants of the measurement program are acknowledged. Without their participation this work could not have been completed. My appreciation is also expressed to Carole Montgomery, who typed the manuscript and assisted in the layout of the figures and tables.

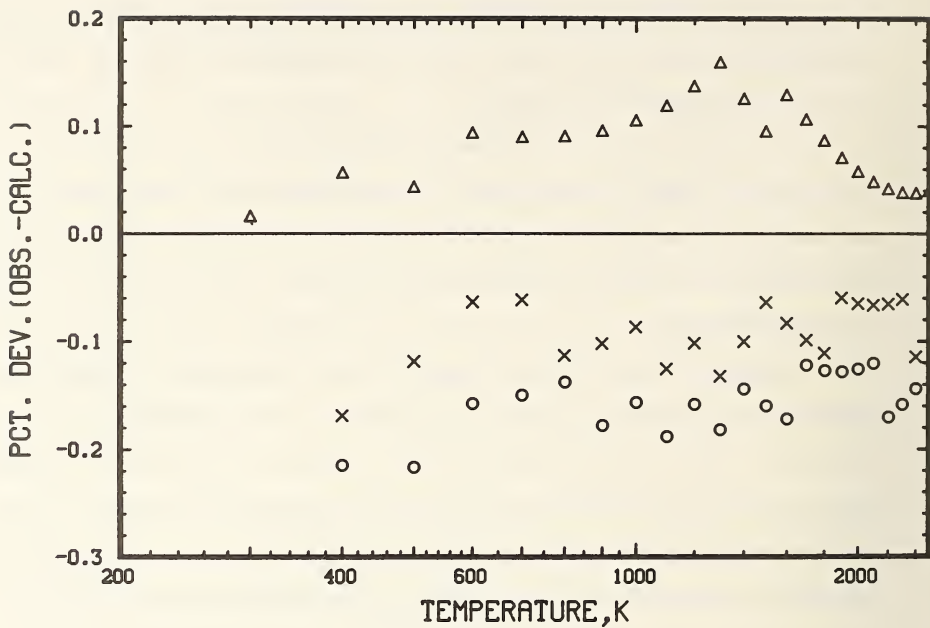

Figure 61. Density deviations for three AXM-5Q1 specimens as reported by Taylor (12) from eq. (5.5.1) for temperatures from 300 to 2500 K.

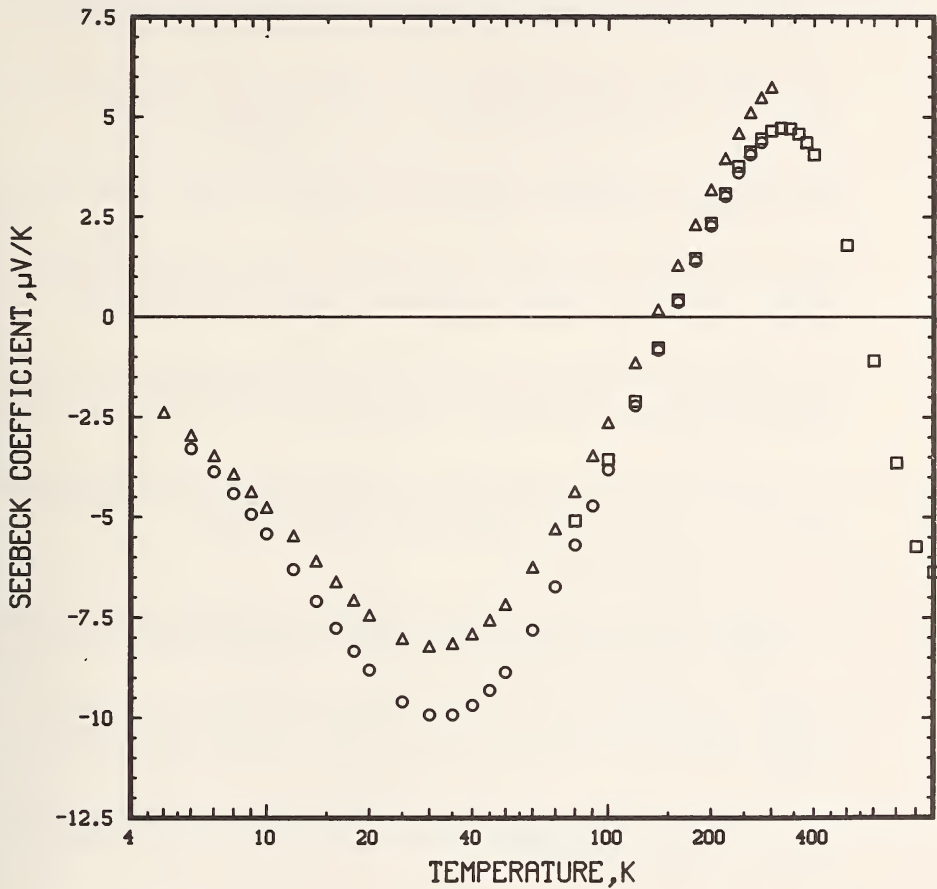

Figure 62. Seebeck coefficient data for three AXM-5Q1 graphite specimens. Two data sets from Hust (7) at temperatures from 5 to 300 K and one set from Moore (11) at temperatures from 80 to 800 K.

## 7. REFERENCES

1. E. Fitzer, Thermophysical Properties of Solid Materials, Advisory Report 12 (1967); Advisory Report 38 (1972); Report 606 (1972), AGARD, NATO, France.
2. M. L. Minges, Evaluation of Selected Refractories as High-Temperature Thermophysical Property Calibration Materials, AFML Technical Report TR-73-278 (1974); Int. J. Heat and Mass Transfer, Vol. 17, 1365-1382 (1974).
3. D. L. McElroy, W. M. Ewing, T. G. Kollie, R. S. Graves, and R. M. Steele, Room Temperature Measurements of Electrical Resistivity and Thermal Conductivity of Various Graphites, ORNL-TM-3477 (1971).
4. K. E. Wilkes, Technical Studies for the NERVA Radiation Effects Program -- Annealing Effects of Temperature on Radiation -- Induced Changes in the Thermal Conductivity of Graphite Materials, Summary Report BMI-NRE-20 (1972).
5. M. L. Minges, The Standard Reference Materials and Data Programs of the CODATA Task Group on Thermophysical Properties, in Proceedings of the 17th International Thermal Conductivity Conference, ed. J. G. Hust, Plenum Press, New York (1983).
6. R. Brandt and G. Neuer, Thermal Diffusivity Measurements on Reference Materials at IKE, in Proceedings of the 17th International Thermal Conductivity Conference, ed. J. G. Hust, Plenum Press, New York (1983).
7. J. G. Hust, unpublished report.
8. L. L. Isaacs and W. Y. Wang, Thermal Properties of POCO-Process Graphite, in Proceedings of the 17th International Thermal Conductivity Conference, ed. J. G. Hust, Plenum Press, New York (1983).
9. K. Maglic, N. Perovic, and Z. Zivotic, Thermal Diffusivity of Candidate Standard Reference Materials, in Proceedings of the 17th International Thermal Conductivity Conference, ed. J. G. Hust, Plenum Press, New York (1983).
10. V. V. Mirkovich, Thermal Diffusivity of a POCO Graphite, in Proceedings of the 17th International Thermal Conductivity Conference, ed. J. G. Hust, Plenum Press, New York (1983).
11. J. P. Moore and R. S. Graves, The Thermal Transport Properties of a POCO AXM-5Q1 Graphite from 80 to 970 K, in Proceedings of the 17th International Thermal Conductivity Conference, ed. J. G. Hust, Plenum Press, New York (1983).
12. R. E. Taylor and H. Groot, Thermophysical Properties of POCO Graphite, High Temperatures--High Pressures, Vol. 12, 147-160 (1980).
13. R. Taylor, Thermal Diffusivity of POCO Graphite and Stainless Steel SRM 735-S in Proceedings of the 17th International Thermal Conductivity Conference, ed. J. G. Hust, Plenum Press, New York (1983).

14. Y. S. Touloukian, R. K. Kirby, R. E. Taylor, and T. Y. R. Lee, Thermophysical Properties of Matter, Vol. 13, Thermal Expansion, Nonmetallic Solids, p. 75, Plenum Press, New York (1977).



U.S. DEPT. OF COMM. BIBLIOGRAPHIC DATA SHEET (See instructions)	1. PUBLICATION OR REPORT NO. NBS/SP-260/89	2. Performing Organ. Report No.	3. Publication Date September 1984
4. TITLE AND SUBTITLE Standard Reference Materials: A Fine-Grained, Isotropic Graphite for Use as NBS Thermophysical Property RM's From 5 to 2500 K			
5. AUTHOR(S) Jerome G. Hust			
6. PERFORMING ORGANIZATION (If joint or other than NBS, see instructions) NATIONAL BUREAU OF STANDARDS DEPARTMENT OF COMMERCE BOULDER, CO 80303		7. Contract/Grant No.	8. Type of Report & Period Covered Final
9. SPONSORING ORGANIZATION NAME AND COMPLETE ADDRESS (Street, City, State, ZIP) Office of Standard Reference Materials National Measurement Laboratory National Bureau of Standards Gaithersburg, MD 20899			
10. SUPPLEMENTARY NOTES  Library of Congress Catalog Card Number: 84-601106  <input type="checkbox"/> Document describes a computer program; SF-185, FIPS Software Summary, is attached.			
11. ABSTRACT (A 200-word or less factual summary of most significant information. If document includes a significant bibliography or literature survey, mention it here) <p>The Chemical Engineering Science Division (Boulder, Colorado) in conjunction with the Office of Standard Reference Materials (Gaithersburg, Maryland) of the National Bureau of Standards, and the CODATA Task Group on Thermal Transport Properties have investigated graphite as a potential, extended temperature range, Research Material (RM). A large number of isotropic, fine-grained graphite rods in various diameters were obtained for these investigations.</p> <p>In Phase I, electrical resistivity and density measurements were performed on numerous rods at temperatures from 4 to 300 K. In Phase II, thermal conductivity measurements were performed on thirteen specimens at about 20 °C. These measurements show that transport property variations, both between and within these rods, is relatively large (approximately 10%). However, a correlation between these variables is shown to exist which will allow the calculation of thermal conductivity from simple and inexpensive electrical resistivity and density measurements to within about ±2%. In Phase III, a large number of specimens were characterized for room temperature electrical resistivity and density. These measurements were in preparation for the world-wide distribution of specimens to participants that agreed to make thermal and electrical property measurements. Phase IV describes the results of the measurements from the various participants. Phase V describes the analysis of these data.</p>			
12. KEY WORDS (Six to twelve entries; alphabetical order; capitalize only proper names; and separate key words by semicolons) characterization; density; electrical resistivity; graphite, Lorenz ratio; Research Materials; thermal conductivity.			
13. AVAILABILITY <input checked="" type="checkbox"/> Unlimited <input type="checkbox"/> For Official Distribution. Do Not Release to NTIS <input checked="" type="checkbox"/> Order From Superintendent of Documents, U.S. Government Printing Office, Washington, D.C. 20402. <input type="checkbox"/> Order From National Technical Information Service (NTIS), Springfield, VA. 22161		14. NO. OF PRINTED PAGES 116 15. Price	

# NBS *Technical Publications*

## *Periodicals*

**Journal of Research**—The Journal of Research of the National Bureau of Standards reports NBS research and development in those disciplines of the physical and engineering sciences in which the Bureau is active. These include physics, chemistry, engineering, mathematics, and computer sciences. Papers cover a broad range of subjects, with major emphasis on measurement methodology and the basic technology underlying standardization. Also included from time to time are survey articles on topics closely related to the Bureau's technical and scientific programs. As a special service to subscribers each issue contains complete citations to all recent Bureau publications in both NBS and non-NBS media. Issued six times a year.

## *Nonperiodicals*

**Monographs**—Major contributions to the technical literature on various subjects related to the Bureau's scientific and technical activities.

**Handbooks**—Recommended codes of engineering and industrial practice (including safety codes) developed in cooperation with interested industries, professional organizations, and regulatory bodies.

**Special Publications**—Include proceedings of conferences sponsored by NBS, NBS annual reports, and other special publications appropriate to this grouping such as wall charts, pocket cards, and bibliographies.

**Applied Mathematics Series**—Mathematical tables, manuals, and studies of special interest to physicists, engineers, chemists, biologists, mathematicians, computer programmers, and others engaged in scientific and technical work.

**National Standard Reference Data Series**—Provides quantitative data on the physical and chemical properties of materials, compiled from the world's literature and critically evaluated. Developed under a worldwide program coordinated by NBS under the authority of the National Standard Data Act (Public Law 90-396).

**NOTE:** The Journal of Physical and Chemical Reference Data (JPCRD) is published quarterly for NBS by the American Chemical Society (ACS) and the American Institute of Physics (AIP). Subscriptions, reprints, and supplements are available from ACS, 1155 Sixteenth St., NW, Washington, DC 20056.

**Building Science Series**—Disseminates technical information developed at the Bureau on building materials, components, systems, and whole structures. The series presents research results, test methods, and performance criteria related to the structural and environmental functions and the durability and safety characteristics of building elements and systems.

**Technical Notes**—Studies or reports which are complete in themselves but restrictive in their treatment of a subject. Analogous to monographs but not so comprehensive in scope or definitive in treatment of the subject area. Often serve as a vehicle for final reports of work performed at NBS under the sponsorship of other government agencies.

**Voluntary Product Standards**—Developed under procedures published by the Department of Commerce in Part 10, Title 15, of the Code of Federal Regulations. The standards establish nationally recognized requirements for products, and provide all concerned interests with a basis for common understanding of the characteristics of the products. NBS administers this program as a supplement to the activities of the private sector standardizing organizations.

**Consumer Information Series**—Practical information, based on NBS research and experience, covering areas of interest to the consumer. Easily understandable language and illustrations provide useful background knowledge for shopping in today's technological marketplace.

*Order the above NBS publications from: Superintendent of Documents, Government Printing Office, Washington, DC 20402.*

*Order the following NBS publications—FIPS and NBSIR's—from the National Technical Information Service, Springfield, VA 22161.*

**Federal Information Processing Standards Publications (FIPS PUB)**—Publications in this series collectively constitute the Federal Information Processing Standards Register. The Register serves as the official source of information in the Federal Government regarding standards issued by NBS pursuant to the Federal Property and Administrative Services Act of 1949 as amended, Public Law 89-306 (79 Stat. 1127), and as implemented by Executive Order 11717 (38 FR 12315, dated May 11, 1973) and Part 6 of Title 15 CFR (Code of Federal Regulations).

**NBS Interagency Reports (NBSIR)**—A special series of interim or final reports on work performed by NBS for outside sponsors (both government and non-government). In general, initial distribution is handled by the sponsor; public distribution is by the National Technical Information Service, Springfield, VA 22161, in paper copy or microfiche form.

**U.S. Department of Commerce**  
National Bureau of Standards  
Gaithersburg, MD 20899

Official Business  
Penalty for Private Use \$300