

10572

NBS MISC. PUBL. 260-14



Standard Reference Materials:

**DETERMINATION OF OXYGEN
IN FERROUS MATERIALS
SRM 1090, 1091, AND 1092**



**U.S. Department of Commerce
National Bureau of Standards**

Q.C.
100
1057
260-14
1966
10572

THE NATIONAL BUREAU OF STANDARDS

The National Bureau of Standards¹ provides measurement and technical information services essential to the efficiency and effectiveness of the work of the Nation's scientists and engineers. The Bureau serves also as a focal point in the Federal Government for assuring maximum application of the physical and engineering sciences to the advancement of technology in industry and commerce. To accomplish this mission, the Bureau is organized into three institutes covering broad program areas of research and services:

THE INSTITUTE FOR BASIC STANDARDS . . . provides the central basis within the United States for a complete and consistent system of physical measurements, coordinates that system with the measurement systems of other nations, and furnishes essential services leading to accurate and uniform physical measurements throughout the Nation's scientific community, industry, and commerce. This Institute comprises a series of divisions, each serving a classical subject matter area:

—Applied Mathematics—Electricity—Metrology—Mechanics—Heat—Atomic Physics—Physical Chemistry—Radiation Physics—Laboratory Astrophysics²—Radio Standards Laboratory,² which includes Radio Standards Physics and Radio Standards Engineering—Office of Standard Reference Data.

THE INSTITUTE FOR MATERIALS RESEARCH . . . conducts materials research and provides associated materials services including mainly reference materials and data on the properties of materials. Beyond its direct interest to the Nation's scientists and engineers, this Institute yields services which are essential to the advancement of technology in industry and commerce. This Institute is organized primarily by technical fields:

—Analytical Chemistry—Metallurgy—Reactor Radiations—Polymers—Inorganic Materials—Cryogenics²—Materials Evaluation Laboratory—Office of Standard Reference Materials.

THE INSTITUTE FOR APPLIED TECHNOLOGY . . . provides technical services to promote the use of available technology and to facilitate technological innovation in industry and government. The principal elements of this Institute are:

—Building Research—Electronic Instrumentation—Textile and Apparel Technology Center—Technical Analysis—Center for Computer Sciences and Technology—Office of Weights and Measures—Office of Engineering Standards Services—Office of Invention and Innovation—Clearinghouse for Federal Scientific and Technical Information.³

¹ Headquarters and Laboratories at Gaithersburg, Maryland, unless otherwise noted; mailing address Washington, D. C., 20234.

² Located at Boulder, Colorado, 80302.

³ Located at 5285 Port Royal Road, Springfield, Virginia, 22151.

Standard Reference Materials:

Determination of Oxygen in Ferrous Materials

SRM 1090, 1091, and 1092

Oscar Menis and J. T. Sterling

Institute for Materials Research
National Bureau of Standards
Washington, D.C.



National Bureau of Standards Miscellaneous Publication 260-14

Issued September 23, 1966

Library of Congress Catalog Card No.: 66-61928

PREFACE

Within the framework of the NBS Institute for Materials Research the area of standard reference materials is a broad and important one, including the preparation, characterization and distribution of a wide variety of materials in such diverse fields as metallurgy, polymers and inorganic materials. In carrying out such a program there is much interaction with representatives of industry and science, beginning with discussions as to which primary standard materials will do most to advance technology, the furnishing of materials and fabrication of samples, and the characterization and certification of the materials by cooperative efforts. The many groups participating in a standards program are very interested in detailed information on specific aspects of the program -- but to date there has been no publication outlet for such written discussions.

To meet this need, NBS Miscellaneous Publication 260 has been reserved for a series of papers in the general area of "standard reference materials". This series will present the results of studies and investigations undertaken within the Institute for Materials Research with emphasis on the preparation and characterization of standard reference materials. This subject-oriented series will provide a means for rapid dissemination of this detailed information and we hope will stimulate the use of standard reference materials in science and industry.

W. Wayne Meinke, Chief
Office of Standard Reference Materials

CONTENTS

| | PAGE |
|--|------|
| 1. INTRODUCTION | 2 |
| 2. SELECTION OF MATERIALS | 4 |
| 3. EXPERIMENTAL | 5 |
| Vacuum Fusion Manometric Apparatus | 5 |
| Vacuum Fusion CO-Infrared Apparatus | 6 |
| Inert Gas Fusion Apparatus | 7 |
| Sample Preparation | 8 |
| Sampling Policy | 8 |
| 4. OBSERVATION AND DISCUSSION | 9 |
| 5. ACKNOWLEDGMENTS | 16 |
| 6. REFERENCES | 26 |
| 7. APPENDIX | 27 |
| (Certificate of Analysis, Standard Reference Materials 1090, 1091, 1092, Oxygen in Ferrous Materials.) | |

LIST OF TABLES

Table No.

| | |
|--|----|
| 1. Effect of sample preparation conditions | 10 |
| 2. Comparison of control and SRM data | 13 |
| 3. Comparison of the mean and precision of cooperating laboratories. SRM 1090-Ingot Iron | 18 |
| 3a. Summary of methods and conditions used at cooperating laboratories. SRM 1090-Ingot Iron | 19 |
| 4. Comparison of the mean and precision of cooperating laboratories. SRM 1091-Stainless Steel (AISI 431) | 20 |

LIST OF TABLES (Con't)

| Table No. | PAGE |
|---|------|
| 4a. Summary of methods and conditions used at cooperating laboratories. SRM 1091-Stainless Steel (AISI 431) | 21 |
| 5. Comparison of the mean and precision of cooperating laboratories. SRM 1092-Vacuum Melted Steel | 22 |
| 5a. Summary of methods and conditions used at cooperating laboratories. SRM 1092-Vacuum Melted Steel | 23 |

LIST OF FIGURES

| Figure No. | |
|--|-------|
| 1. Schematic diagram of vacuum-fusion-manometric apparatus | 5 |
| 2. Schematic diagram of vacuum-fusion-CO infrared apparatus | 6 |
| 3. Schematic diagram of inert gas fusion apparatus | 7 |
| 4. Control data and homogeneity study of NBS-SRM 1090 ingot iron | 12 |
| 5. Control chart of a single rod of NBS-SRM 1091 high alloy steel | 12 |
| 6. Control chart of a single rod NBS-SRM 1092 vacuum melted steel | 13 |
| 7. Homogeneity study - determination from a single rod for sample weight 0.2 to 2 grams . | 14 s |
| 8. Summary of precision and accuracy of cooperating laboratories for SRM 1090, 1091 and 1092 | 24,25 |

STANDARD REFERENCE MATERIALS
DETERMINATION OF OXYGEN IN FERROUS MATERIALS -
SRM 1090, 1091 and 1092

Oscar Menis and J. T. Sterling

Institute for Materials Research
National Bureau of Standards

ABSTRACT

A description is presented of methods used for the determination of homogeneity and the establishment of the oxygen values certified by NBS for three ferrous standard reference materials. These standards are represented by two low alloy materials, ingot and vacuum melted iron containing 484 and 28 ppm of oxygen respectively, and a high alloy steel containing 131 ppm of oxygen. The analyses of these materials are based on two vacuum fusion procedures. The poor results for the high alloy steel obtained by the first of these methods are explained. The first method is based on manometric measurements and depends on the conversion of CO to CO₂ by copper oxide and on a differential freezing of gases. In the second method a system is used which provides a highly efficient degassing of sample and a direct measurement of CO by infrared absorbancy. Additional data from an analysis by inert gas fusion method also indicate that the homogeneity of a single rod of ingot iron, over a wide range of sample size, has a relative standard deviation of less than two per cent. From control data and homogeneity studies it was ascertained that the uncertainty limits stated in the NBS certificate include the error due to the relative inhomogeneity between rods. Finally, data from eighteen laboratories cooperating in this program are presented.

Key words: vacuum fusion, inert gas fusion, oxygen, ferrous standard reference materials, CO by infrared absorbancy, homogeneity, certified value, eighteen cooperating laboratories.

1. INTRODUCTION

It has been well established that even at low concentrations, the oxygen content of ferrous and non-ferrous metals has a pronounced effect (most frequently deleterious) on their physical and mechanical properties. The need for accurate methods for its determination in these materials is therefore quite obvious.

The instrumental methods currently used for the determination of oxygen in metals require standards for calibrating apparatus as well as to provide material for inter-laboratory comparisons and agreement on values. The latter problem is very timely as evident from a current report at an annual meeting of Division I, Committee E-3 of ASTM at St. Joseph, Michigan, April 4-5, 1966. Over a period of two years they have been working on round robin studies intended to establish criteria for control of variables in order to bring about inter-laboratory agreement for an oxygen value in a sample of material. Earlier correspondence with producers and consumers, including members of the Iron and Steel Institute, also pointed up the need for a certified material.

This report deals mainly with the results of analysis of the ferrous material which led to the certification of three Standard Reference Materials. In this study at the NBS Analytical Chemistry Division, the vacuum fusion and gas evolution methods were employed. A discussion is presented of the problems associated with homogeneity testing, establishing the precision and accuracy, and with the evaluation of results from cooperating laboratories.

The choice of the methods and the selection of the material is based on the Bureau's long experience in these areas. Historically, as early as about 1925, Jordan and Eckman of the National Bureau of Standards published a method for the determination of oxygen and hydrogen in metals by fusion in a vacuum [1]. Oberhoffer and Schenck published in Stahl u. Eisen [2] a report which also contributed to the development of the vacuum fusion method for the determination of gases in metals. In 1937 an NBS publication [3] thoroughly described an international cooperative effort both to evaluate the accuracy of the vacuum fusion method and to compare it with other chemical methods.

Sloman and his associates in England were the first investigators to systematically study this method. This group has published a large number of papers dealing with the subject. The most important from a theoretical point of view is that found in the 1952 issue of the Journal of the

Institute of Metals [4]. The other method, an inert-gas fusion procedure, was introduced by Smiley [5] who used capillary traps and manometric measurements. Since then other methods of measurements, such as conductivity measurements and more recently, gas chromatographic analysis have provided convenient and rapid methods for the determination of the evolved CO gas.

A new modification of vacuum fusion apparatus consisting of a resistance heated all metal vacuum fusion apparatus using an infra-red measurement of the evolved carbon monoxide was discussed by Kraus [6] in 1962. A recent review describing the various techniques used for the gas analysis in metals has been presented by James [7]. Other methods, such as activation analysis [8] and Fassel's modification of an inert gas fusion by means of an arc melting and chromatographic determination of oxygen as carbon monoxide have recently come to the forefront [9].

2. SELECTION OF MATERIALS

The Bureau with the cooperation of the AISI, for the purpose of producing suitable Standard Reference Materials, procured several ferrous materials. These included an ingot iron, a stainless steel (AISI 431) and a vacuum melted steel. The ingot iron was obtained from the Armco Steel Corporation in the form of 1/4 inch diameter centerless ground rods, 12 feet long from a single heat preparation. It is a low-alloy material with a low carbon and a relatively high oxygen content. Its nominal composition is as follows: C = 0.026%, Mn = 0.043%, P = 0.004%, S = 0.016%, Si = 0.004%, Cu = 0.095%. The second sample, a stainless steel (AISI 431) alloy, was obtained from the Jones and Laughlin Steel Corporation in the form of centerless ground 5/16" diameter rods, 12 feet long and likewise prepared from a single heat. This high alloy steel contains an especially high percentage of chromium which could conceivably be a source of some difficulties in an oxygen determination. It would therefore serve as a critical standard for checking out procedures under more demanding conditions. The material has a nominal composition as follows: C = 0.15%, Ni = 2.2%, Cr = 15.8%, V = 0.04%, N = .07%. The alloy is an important structural material in today's technology. It contains intermediate amounts of oxygen and relatively high amounts of nitrogen. The third material, a vacuum melted steel, contains low concentration of impurities as well as a low oxygen content. The nominal composition of this material is as follows: C = 0.016%, Mn 0.01%, P = .001%, S = .006%, Si = 0.008%, Ni = .023%, Cr = 0.002%. It was supplied as 1/4 inch diameter rods approximately 3 feet long by the United States Steel Corporation.

These materials are intended primarily for the calibration of vacuum fusion and inert gas evolution apparatus, the two most commonly used instruments and to provide standards for interlaboratory checking.

3. EXPERIMENTAL

Three types of equipment were used in this study:

(1) Vacuum fusion-manometric measurement apparatus (NRC-912)*, National Research Corporation, Newton Highland, Massachusetts, is shown schematically in figure 1. The sample was introduced into a previously outgassed system at 10^{-5} torr by means of sample addition devices (A) into an inductively heated furnace (B) where it was vacuum melted in the graphite crucible at 1650°C . The evolved gas was collected for 20 minutes in the calibrated McLeod gauge (D),

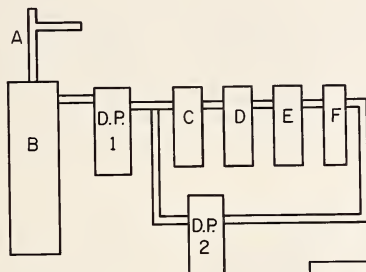

A = SAMPLE ADDITION DEVICE
B = FURNACE (INDUCTION)
C = TOEPLER PUMP
D = McLEOD GAUGE
E = COPPER OXIDE FURNACE
F = FREEZE TRAP
D.P.1. AND D.P.2 = DIFFUSION PUMPS (MERCURY)

CONDITIONS FOR ANALYSIS

TEMPERATURE 1650°C
PRESSURE 10^{-5} TORR
COLLECTION TIME - 15 MIN
BATH - IRON

Figure 1. Schematic diagram of vacuum-fusion-manometric apparatus.

*Certain commercial materials and equipment are identified in this paper in order to adequately specify the experimental procedure. In no case does such identification imply recommendation or endorsement by the National Bureau of Standards, nor does it imply that the material or equipment identified is necessarily the best available for the purpose.

with a collector pump DPl and Toeppler pump (C). The total pressure was then measured. Next, by means of the pump DP2, the gas was circulated through a heated copper oxide tube where the CO and H₂ were converted to CO₂ and H₂O respectively. About 10 minutes were usually required to obtain a constant pressure. Condensable gases were retained in a liquid nitrogen cold trap and any residual gas was then measured as nitrogen. The cold trap was next changed to a dry ice-trichloroethylene system and the evolved CO₂ measured manometrically in the McLeod gauge. Based² on these measurements, the amounts of gaseous components were calculated from the PVT relationships.

(2) The second vacuum fusion apparatus, Gas Analyser Exhalograph EA-1*, Bendix-Balzers Vacuum, Inc., Rochester, N. Y., is shown schematically in figure 2. The sample was introduced by means of the vacuum sample chamber (B) into a pre-outgassed system. The system was initially brought to a pressure less than 10⁻⁶ torr by means of a graphite rod resistance furnace (A). The sample was vacuum melted in a graphite crucible at 1650 °C. Next, with a high capacity

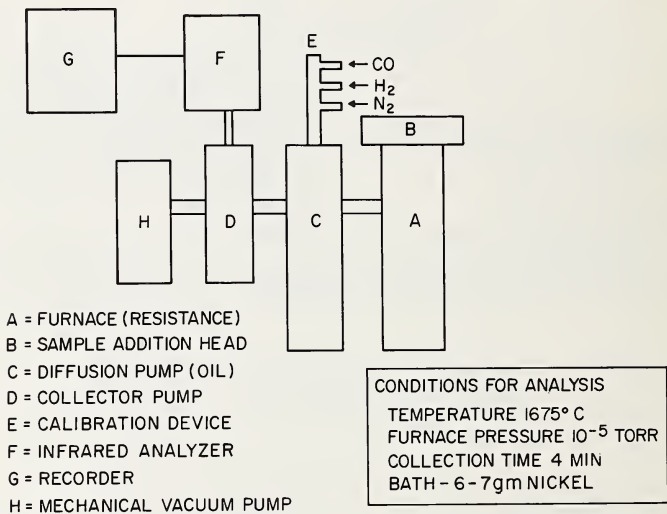

Figure 2. Schematic diagram of vacuum-fusion-CO infrared apparatus.

* See footnote on page 5.

oil diffusion pump (C) the evolved gas was transferred into the collector pump (D) and was contained in a standard volume. Because of the high efficiency of the pumps, this process takes less than 30 seconds. In practice, however, the collection time was extended over a period of 4 minutes. The gaseous components were measured as follows: CO in a calibrated infrared analyzer, H₂ by thermal conductivity and nitrogen or the residual gas manometrically. All these operations were carried out semi-automatically and the data were collected on a strip chart recorder. The apparatus also contained a gas injection system (E) by which the measuring systems for the three gases were calibrated, by the introduction of standard volumes of O₂, H₂ and N₂.

(3) The third instrument, an inert gas fusion apparatus, The Leco Carbon Analyzer*, Laboratory Equipment Corp., St. Joseph, Michigan, is shown schematically in figure 3.

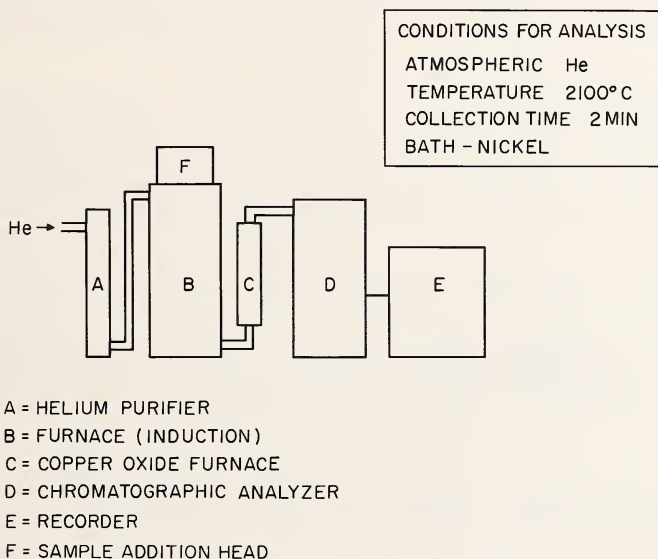

Figure 3. Schematic diagram of inert gas fusion apparatus.

* See footnote on page 5.

The sample was introduced into the furnace chamber (B) by means of a sample addition head (F). It was then melted in a previously outgassed graphite crucible which was heated inductively to 2100 °C. The apparatus was operated under a flow of prepurified helium. The evolved CO gas was collected over a 2-minute period and converted to CO₂ by copper oxide heated in a furnace (C) and then introduced into a chromatographic system (D) where it was collected and measured with a thermoconductivity cell, whose output was recorded either in an integrating clock or on a strip chart recorder (E).

Sample Preparation:

Samples from rods ranging from 0.4 to 2 grams were sawed by hand to obtain a complete cross section. The surfaces were carefully abraded with a clean sharp file, degreased with CP acetone and then dried in warm air. The samples after cutting were handled only with clean oil free forceps and tested within an hour.

Sampling Policy:

(1) Ingot Iron - Since there was no recorded history of the consecutive position of the rods from the single heat, they had to be sampled at random. It was discovered, after a considerable number of analyses, that the material was segregated into two groups of different oxygen content and it was necessary to analyze a 0.4-g sample from each of the 12-ft rods in order to sort them into their respective lots. Only one of these groups has been certified at this time.

(2) Stainless Steel (AISI 431) - This material was also received with no history as to the consecutiveness of the rods. Therefore, rods were again taken at random and 0.8-g samples were cut from these rods at both ends and from the middle for analysis specimens.

(3) Vacuum Melted Steel - These rods were received in approximately 3-ft lengths and 2-g samples were taken from each rod.

4. OBSERVATION AND DISCUSSION

In certifying the oxygen content of the three ferrous materials an effort was made to assure the highest degree of accuracy. Unfortunately the preparation of this type of standard does not lend itself to synthetic control. The goals of certifying materials to contain known amounts of oxygen must be attained by assuring that the material has the best homogeneity, and that the methods used to establish the certified values do not suffer from systematic errors. In this report the method of evaluating the homogeneity is presented and data obtained by two relatively independent methods are shown. These were used to establish the certified values. It is to be expected that, if two methods are based on operations which are not basically alike, the agreement in the values obtained between these are not primarily fortuitous. In addition, results are included from cooperating laboratories.

In order to attain the highest degree of accuracy all the potential sources of error must be carefully controlled. As stated in the introduction, the vacuum fusion method has been thoroughly studied and evaluated. The critical requirements of these methods are well understood and have been adhered to in the current work. With the few stated exceptions most of the conditions involved in this procedure were therefore not re-examined.

Starting with the sample preparation as the first condition, it has been long established that the surface area to weight ratio should be minimized. This ideally requires a production of a spherical sample. Since spheres of uniform oxygen content are difficult to manufacture, the actual sample used was a cylindrical section from a rod. This form, however, closely approximates the requirement of a minimum surface-to-weight ratio.

The requirement of minimum surface contamination in the process of sample preparation is evident. Therefore, an additional test was carried out with a special sample to ascertain the best method. As shown in table 1, the values obtained by a method in which the sample was more drastically treated with an abrasion wheel lead to higher results. It is evident that such a treatment contaminates the surface with oxygen. For that reason, the slower and more reliable filing process as described in the Experimental Section was used throughout these tests.

Table 1. Effect of sample preparation conditions.

| Sample No. | Sample ^a Treatment | Oxygen, ppm | | |
|------------|----------------------------------|-------------|-----------|---------------------|
| | | Mean | Std. Dev. | Rel. Std. Dev. % |
| 431-6 | A | 171.3 | .96 | .6 |
| | B | 136.2 | 1.9 | 1.4 |
| 431-9 | A | 170.5 | 5.26 | 3.1 |
| | B | 131.2 | 1.3 | 1.0 |
| 431-12 | A | 142.0 | 9.7 | 6.8 |
| | B | 134.8 | 1.9 | 1.4 |
| 431-Cont. | A | 157.3 | 10.5 | 6.7 |
| | B | 135.3 | 2.9 | 2.1 |

^aSample treatment: (A) Cut with water coated slitting wheel and grind surfaces on a Buehler paper disc grinder with a No. 120 grit silicon carbide paper. (B) Hand hacksaw used to cut specimen and surface cleaned by filing with a clean sharp file.

The next parameter has to do with the optimum temperature that must be employed with these types of materials. It again has been widely established that 1650 °C assures the complete release of oxygen from the three types of materials studied.

In the two vacuum apparatus, two different fusion baths also were used, an iron and a nickel. In both cases it has been proven that they fulfill the role of good dispersants for the carbide formed in the fusion reaction which in turn produces surface agglomerates in the form of "kish" or "dross". However, since some of the data by the cooperating laboratories were carried out in platinum, an additional test was carried out using a platinum bath and flux at 1900 °C. The results of this experiment yielded for six determinations on SRM 1092 an average value of 31.5 ppm + 6%. This value is within the statistical limits of the certified value. Thus, in this case, the use of the platinum bath does not significantly affect the value for oxygen.

It also has been proven that the high rate of outgassing and high vacuum necessary for the release of the evolved CO is critical. This is especially true where gettering of the released CO may occur by a volatile component of the sample. With both instruments used at the Bureau, one employing a mercury diffusion pump and the other a highly efficient oil diffusion pump, these requirements have been met. One advantage of the oil diffusion pump is that it has a higher capacity and pumping speed and permits a faster outgassing of carbon monoxide from the sample melt. Any errors due to losses from gettering of CO in the system are therefore minimized.

The final step in the methods is the measurement of the evolved carbon monoxide. Two basically different methods were used, one a manometric measurement with a calibrated McLeod gauge and the other, an infrared absorbancy measurement of carbon monoxide. In the manometric measurements there are the additional steps for the conversion of carbon monoxide to the carbon dioxide by means of a copper oxide reactor and the differential freezing of CO_2 and H_2O . The use of CuO at the Bureau has been described previously [10]. It performed satisfactorily in the case of the low alloy materials, such as the high oxygen sample of the ingot iron, and the low oxygen vacuum melted iron. However, with the 431 stainless steel high alloy type material, the results were erratic. This is apparent from the data reported in table 4 dealing with the results from cooperating laboratories. The mean value given for Lab. NBS-A was low and the relative error large. An examination of the copper oxide used in the analysis indicated that contamination from the sample had occurred and losses through gettering and reduced efficiency of the reagent may account for the low and erratic results. The second method of measurement by infrared absorbancy is based on calibration with standard volumes of carbon monoxide and offered an independent check on the accuracy of the measurement without the associated problem of CO to CO_2 conversion.

In the analysis of large numbers of samples from the different materials an effort was made to check the reproducibility of the method over a long period of time and to evaluate the error arising from samples taken from different rods. In the case of SRM 1091 and 1092 consecutive samples from the same rod were taken and analyzed over a period of 15 and 10 days, respectively. In the case of SRM 1090 duplicates of adjacent samples were also taken from the center of the rods. These can be compared with all the analyses recorded and used to obtain the certified value. As shown in figures 4, 5 and 6 and also summarized in table 2, there is no significant difference in the precision for the control and SRM samples for SRM 1091 Stainless Steel and 1090 Ingot Iron. In the latter case duplicate samples B and B', as shown in figure 4, also reflect the relative

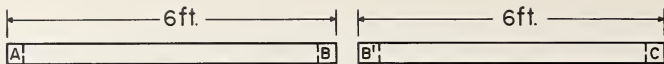

| MATERIAL | RODS ANALYZED | NUMBER OF DETERMINATIONS | MEAN ppm | SD ppm | R _{SD} % |
|---|---------------|--------------------------|----------|--------|-------------------|
| NBS - SRM 1090 SAMPLES - B & B' | 17 | 34 | 494.7 | 8.7 | 1.8 |
| NBS - SRM 1090 SAMPLES - A, B, B', & C | 17 | 68 | 494.9 | 15.1 | 3.1 |

Figure 4. Control data and homogeneity study of NBS-SRM 1090 ingot iron.

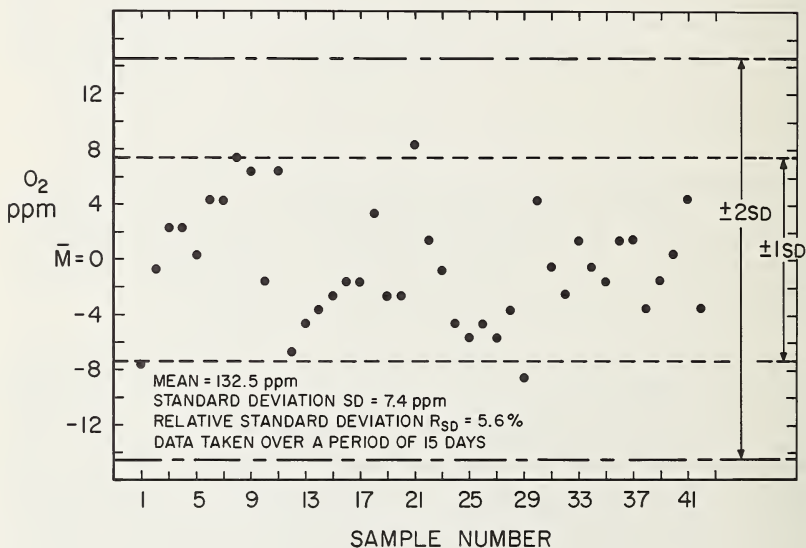

Figure 5. Control chart of a single rod of NBS-SRM 1091 high alloy steel.

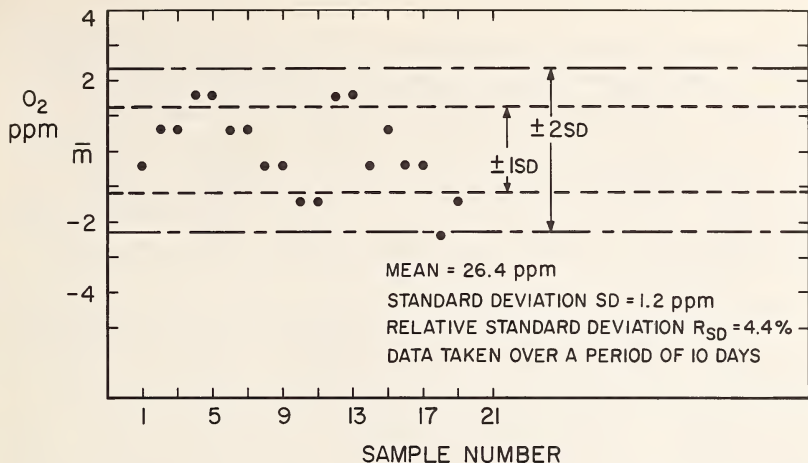

Figure 6. Control chart of a single rod NBS-SRM 1092 vacuum melted steel.

Table 2. Comparison of control and SRM data.

| SRM | Control Data ^a | | | | SRM Data ^a | | | |
|------|---------------------------|------|----------------------------|-------------------------|-----------------------|----|----------------------------|-------------------------|
| | Oxygen, ppm | | Relative Std. Dev. % | Number of Determ. | Oxygen, ppm | | Relative Std. Dev. % | Number of Determ. |
| Mean | Std. Dev. | Mean | | | Std. Dev. | | | |
| 1090 | 26.4 | 1.2 | 4.4 | 21 | 28 | 2 | 7.1 | 105 |
| 1090 | 132.5 | 7.4 | 5.6 | 41 | 131 | 8 | 6.1 | 286 |
| 1090 | 494.9 | 15.1 | 3.1 | 68 _b | 484.1 | 14 | 2.9 | 216 |
| | 494.7 | 8.7 | 1.8 | 34 _b | | | | |

^aTaken over a period of 10 to 15 days.

^bBased on duplicate determination from adjacent positions on a rod.

homogeneity in that the determinations from duplicate samples taken from adjacent position yield the greatest precision. The data from the SRM 1092 vacuum melted material also indicate a higher precision, the error being less from samples taken from consecutive positions. One can conclude therefore that the relative homogeneity of the rods are the dominant factors which set the limit of accuracy. The precision in the determination of oxygen from a portion of a typical 4-inch SRM sample should be better than the overall uncertainty in accuracy which is stated in the certificate (see appendix).

In addition, a limited study was carried out using an inert gas fusion apparatus in combination with a gas chromatographic measuring unit. Unfortunately, because of the initial difficulties with the integrator clock used as the readout device, the study is limited. The data are the measurement of the thermal conductivity output from the chromatograph with a recorder. Data are presented in figure 7 for consecutive samples of ingot iron which varied

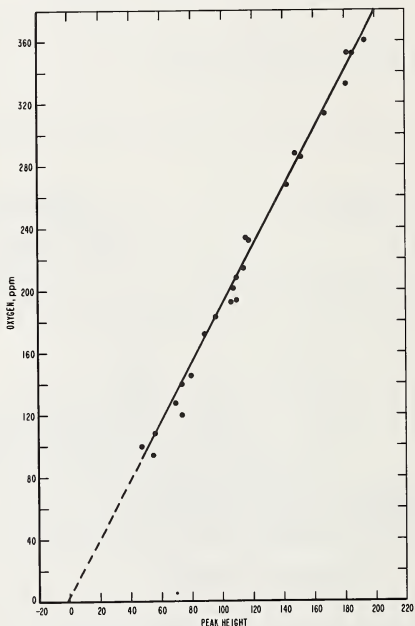

Figure 7. Homogeneity study - determination from a single rod for sample weight 0.2 to 2 grams.

in weight from 0.2 g to 2 g. The relative standard deviation of the slope of the line was less than 2%. Since this value is based on data taken over a wide range of sample weight it also indicates a relative high degree of homogeneity of the oxygen content within a given rod.

Finally, tables 3, 3a, 4, 4a, 5 and 5a and figure 8 are presented showing the results from the various cooperating laboratories.

If we use the generally accepted criteria for rejection of values from a given laboratory whose relative standard deviation at the 500, 100 and 30 ppm levels is greater than 5, 10 and 20 per cent respectively, one finds on inspection of these data the following:

(1) Ingot Iron: (SRM 1090)

- a. Fourteen out of 19 laboratories reported results with relative standard deviation less than 5 per cent*.
- b. Eleven of the fourteen laboratories reported mean values which fell within the two-standard deviation limits of the certified values for SRM 1090.
- c. The mean oxygen value of these eleven laboratories is 474 ppm.*

(2) Stainless Steel:(AISI 431)

- a. Ten out of the 18 laboratories reported results with relative standard deviation of less than 10 per cent.
- b. Ten of the ten laboratories reported means which fell within the two standard deviation limits set up as the certified values of the SRM 1091.
- c. The mean oxygen value for these ten laboratories is 126 ppm.

(3) Vacuum Melted Steel: (SRM 1092)

- a. Eighteen out of 19 laboratories reported results which had a relative standard deviation of less than 20 per cent.
- b. Thirteen of the eighteen laboratories reported mean values which fell within the two standard deviation limits set up as the certified values for SRM 1091.
- c. The mean oxygen value for these 13 laboratories is 28.6 ppm

*Some of the laboratories reported on sample number 10. It was found that this bar contained oxygen at a higher level; therefore, the results received from these laboratories were adjusted so as not to include results obtained on this specimen.

It is evident from these reports that the best general agreement was obtained on samples from low alloy content material. A larger number of cooperating laboratories had poorer results with the high alloy steel standard.

5. ACKNOWLEDGMENTS

We would like to acknowledge our indebtedness to Mr. Francis Palumbo who made many of the determinations using the NRC-912 and inert gas fusion apparatus and especially to the cooperating laboratories listed below who gave generously of their time and talents in analyzing these materials.

Cooperating Laboratories

- A. O. Smith Corp., Milwaukee, Wisconsin. (D. E. Wallschlaeger)
- Allegheny-Ludlum Steel Corp., Brackenridge Works, Brackenridge, Pa. (D. P. Bartell)
- Applied Research Laboratory, U. S. Steel Corp., Monroeville, Pa. (L. M. Melnick, J. F. Martin, and R. Rapp)
- Battelle Memorial Institute, Columbus, Ohio. (M. W. Mallett)
- Bethlehem Steel Co., Bethlehem, Pa. (D. W. Murphy)
- Bettis Atomic Power Laboratory, Westinghouse Electric Corp., Pittsburgh, Pa. (D. L. Smith)
- Crucible Steel Company of America, Midland Works, Midland, Pa. (R. L. Rudolph)
- Graham Research Laboratory, Jones and Laughlin Steel Corp., Pittsburgh, Pa. (L. Pasztor)
- Institute for Atomic Research and Department of Chemistry, Iowa State University, Ames, Iowa. (V. A. Fassel and W. E. Dallmann)
- Knolls Atomic Power Laboratory, General Electric Co., Schnectady, N. Y. (R. F. Dufour)
- Laboratory Equipment Corp., St. Joseph, Michigan. (H. J. Schmitt and G. Helling)

Lamp Division, Westinghouse Electric Corp., Bloomfield, New Jersey. (M. F. Quaely)

Large Steam Turbine-Generator Department, Materials and Processes Laboratory, General Electric Co., Schenectady, N. Y. (C. C. Carson)

National Research Corp., Cambridge, Mass. (J. P. Martin)

Research and Development Center, Westinghouse Electric Corp., Pittsburgh, Pa. (W. F. Harris)

Research Center, Republic Steel Corp., Cleveland, Ohio. (M. K. Weiss)

Research Laboratory, The International Nickel Company, Inc., Sterling Forest, Suffern, N. Y. (C. H. Albright)

Technology Department, Union Carbide Metals Co., Niagara Falls, N. Y. (L. A. DeAeth)

The Youngstown Sheet and Tube Co., Youngstown, Ohio. (W. F. Harris)

U. S. Army Materials Research Agency, Watertown, Mass. (S. Vigo and F. P. Valenti)

Table 3. Comparison of the mean and precision of cooperating laboratories.

| SRM 1090 - Ingot Iron | | | | |
|-----------------------|-------|-----------|----------------------|-------------------|
| <u>Oxygen, ppm</u> | | | | |
| Lab. | Mean | Std. Dev. | Relative Std. Dev. % | Number of Determ. |
| 1 | 466.3 | 29.5 | 6.3 | 30 |
| 2 | 699.2 | 348.4 | 49.8 | 12 |
| 3 | 455.8 | 20.2 | 4.4 | 12 |
| 4 | 410.8 | 33.7 | 8.2 | 12 |
| 5 | 504.4 | 13.4 | 2.7 | 9 |
| 6 | 459.2 | 17.8 | 3.9 | 12 |
| 7 | 497.7 | 9.7 | 1.8 | 11 |
| 8 | 509.1 | 12.3 | 2.4 | 9 |
| 9 | 459.9 | 31.4 | 6.8 | 12 |
| 10 | 456.0 | 9.1 | 2.0 | 15 |
| 11 | 449.2 | 27.4 | 6.1 | 12 |
| 12 | 454.9 | 16.7 | 3.7 | 15 |
| 13 | 465.5 | 9.0 | 1.9 | 9 |
| 14 | 458.9 | 19.6 | 4.3 | 9 |
| 15 | 446.7 | 6.9 | 1.5 | 12 |
| 16 | 443.5 | 7.1 | 1.6 | 12 |
| 17 | 532.3 | 23.8 | 4.5 | 6 |
| NBS-A ^a | 462.9 | 11.2 | 2.4 | 88 |
| NBS-B ^b | 484 | 14 | 2.9 | 216 |

^aSee footnote l in table 3a.

^bSee footnote m in table 3a.

Table 3a. Summary of methods and conditions used at cooperating laboratories.

SRM 1090 - Ingot Iron

| Lab. | Method | Temperature °C | Collection time (min.) | Weight of sample (g) | Bath |
|-------|-------------------------------|-------------------|------------------------------|-------------------------------|-----------------|
| 1 | Vacuum fusion ^a | 1650 | 30 | 2 | None |
| 2 | Vacuum fusion | 1650 | -- | 1.0-1.5 | None |
| 3 | Inert gas fusion ^b | 2350 | 6 | 0.4-0.7 | Pt ^c |
| 4 | Vacuum fusion | 1650 | 15 | 0.3-0.5 | Fe |
| 5 | Vacuum fusion | 1650 | -- | .6-1.9 | Fe |
| 6 | No information available | | | | |
| 7 | Vacuum fusion ^d | 1700 | 3 | 0.5-1.5 | Ni-Fe |
| 8 | Inert gas fusion ^b | 2000 | -- | 0.5-2.5 | None |
| 9 | Vacuum fusion ^e | 1850 | 5 | 1.0-1.4 | Pt ^f |
| 10 | Vacuum fusion | 1700-1800 | 10 | 1.0-2.5 | None |
| 11 | Vacuum fusion | 1650 | 20 | 0.7-3.0 | Fe ^g |
| 12 | Vacuum fusion ^h | 1650 ⁱ | 20 | 1.0-2.0 | Fe |
| 13 | Vacuum fusion ^h | 1850 | 20 | 1 | Fe |
| 14 | Vacuum fusion ^h | 1650 | -- | 1.2-1.8 | None |
| 15 | Vacuum fusion | 1950 | 5 | 0.5 | Pt ^j |
| 16 | Vacuum fusion ^h | 1830-1920 | 15 | 1.1-1.8 | None |
| 17 | Vacuum fusion ^k | 1650 | 15 | 1 | Fe |
| NES-A | Vacuum fusion ^l | 1650 | 20 | 2 | None |
| NES-B | Vacuum fusion ^d | 1650 | 4 | 0.5 | Ni ^m |

^aConstructed in laboratory.

^bLeco.

^cPt: sample = 6:1.

^dB.B. Exhalograph EA-1.

^eUsed Model 21-610 mass spectrometer for analysis of gases.

^fPt: sample = 1.3:1.

^gFive grams Fe.

^hNRC.

ⁱA few samples run using Pt bath 1950-2000 °C.

^j2.5 g Pt degassed for 3 minutes before each sample is added.

^kSerfass analyzer

^lNRC-modified for fractional freezing.

^mApproximately 7 grams Ni bath used.

Table 4. Comparison of the mean and precision of cooperating laboratories.

SRM 1091 - Stainless Steel
(AISI 431)

| Lab. | Oxygen, ppm | | Relative Std. Dev. % | Number of Determ. |
|--------------------|-------------|--------------|----------------------------|-------------------------|
| | Mean | Std. Dev. | | |
| 1 | 41.2 | 12.2 | 29.2 | 30 |
| 2 | 100.0 | 22.7 | 22.7 | 20 |
| 3 | 98.3 | 29.2 | 29.7 | 12 |
| 4 | 134.2 | 5.2 | 3.8 | 12 |
| 6 | 120.8 | 5.2 | 4.3 | 12 |
| 7 | 125.3 | 6.2 | 4.9 | 13 |
| 8 | 127.0 | 6.5 | 5.1 | 12 |
| 9 | 72.2 | 17.5 | 24.3 | 12 |
| 10 | 128.0 | 7.8 | 6.1 | 15 |
| 11 | 107.7 | 16.6 | 15.4 | 14 |
| 12 | 120.3 | 4.1 | 3.4 | 12 |
| 13 | 132.0 | 24.3 | 18.4 | 17 |
| 14 | 118.9 | 9.7 | 8.2 | 12 |
| 15 | 99.5 | 11.3 | 11.4 | 12 |
| 16 | 113.9 | 5.3 | 4.7 | 12 |
| 17 | 136.2 | 2.9 | 2.1 | 9 |
| NBS-A ^a | 104.3 | 14.6 | 14.0 | 85 |
| NBS-B ^b | 131 | 8 | 6.1 | 286 |

^aSee footnote n in table 4a.

^bSee footnote d in table 4a.

Table 4a. Summary of methods and conditions used at cooperating laboratories.

SRM 1091 - Stainless Steel
(AISI 431)

| Lab. | Method | Temperature °C | Collection time (min.) | Weight of sample (g) | Bath |
|-------|-------------------------------|-------------------|------------------------------|-------------------------------|-------------------|
| 1 | Vacuum fusion ^a | 1650 | 30 | 2 | None |
| 2 | Vacuum fusion | 1650 | -- | 1.0-1.5 | None |
| 3 | Inert gas fusion ^b | 2350 | 6 | 0.4-0.7 | Pt ^c |
| 4 | Vacuum fusion | 1650 | 15 | 0.3-0.5 | Fe |
| 6 | No information available | | | | |
| 7 | Vacuum fusion ^d | 1900 | 3 | 0.5-1.5 | Pt ^e |
| 8 | Inert gas fusion ^b | 2000 | -- | 0.5-2.5 | None |
| 9 | Vacuum fusion ^f | 1850 | 5 | 1.0-1.4 | Pt ^g |
| 10 | Vacuum fusion | 1700-1800 | 10 | 1.0-2.5 | None |
| 11 | Vacuum fusion | 1650 | 20 | 0.6-3.8 | Fe ^h |
| 12 | Vacuum fusion ⁱ | 1650 | 20 | 1.0-2.0 | Fe ^j |
| 13 | Vacuum fusion ⁱ | 1850 | 20 | 1.0 | Fe |
| 14 | Vacuum fusion ⁱ | 1800 | -- | 1.6-2.0 | None |
| | | 1975 | -- | 1.6-2.0 | Pt&Sn |
| 15 | Vacuum fusion | 1950 | 5 | 0.5 | Pt ^k |
| 16 | Vacuum fusion ⁱ | 1830-1920 | 15 | 1.1-1.8 | None ^l |
| 17 | Vacuum fusion ^m | 1650 | 15 | 0.75 | Fe |
| NBS-A | Vacuum fusion ⁿ | 1650 | 20 | 0.5 | None |
| NBS-B | Vacuum fusion ^d | 1650 | 4 | 0.75 | Ni ^o |

^aConstructed in laboratory.

^bLeco.

^cPt; sample = 6:1.

^dB.B. Exhalograph EA-1.

^e25 g Pt bath maintained at

least Pt: S = 3:1.

^fUsed model 21-610 mass spec-
trometer for analysis of gases.

^gPt; sample = 1.3:1.

^hFive grams Fe.

ⁱNRC.

^jA few samples run using Pt
bath at 1950-2000 °C.

^k2.5 g Pt degasses for 3
minutes before sample is added.

^lTin added intermittently.

^mSerfass analyzer.

ⁿNRC-modified for fractional
freezing.

^oApproximately 7 grams Ni
bath used.

Table 5. Comparison of the mean and precision of cooperating laboratories.

SRM 1092 - Vacuum Melted Steel

| Lab. | <u>Oxygen, ppm</u> | | Relative Std. Dev. % | Number of Determ. |
|--------------------|--------------------|--------------|----------------------------|-------------------------|
| | Mean | Std. Dev. | | |
| 1 | 19.0 | 6.7 | 35.1 | 12 |
| 2 | 28.7 | 1.6 | 5.5 | 9 |
| 3 | 28.3 | 4.1 | 14.4 | 6 |
| 4 | 35.3 | 3.5 | 10.0 | 9 |
| 5 | 28.8 | .4 | 1.3 | 6 |
| 6 | 30.2 | 1.5 | 4.9 | 9 |
| 7 | 28.6 | .52 | 1.8 | 8 |
| 8 | 27.1 | 2.9 | 10.7 | 8 |
| 9 | 23.3 | 1.9 | 88.0 | 6 |
| 10 | 26.7 | 5.2 | 19.3 | 6 |
| 11 | 28.9 | 1.5 | 5.0 | 9 |
| 12 | 28.3 | .9 | 3.2 | 8 |
| 13 | 31.0 | 2.4 | 7.7 | 6 |
| 14 | 25.5 | 2.3 | 9.1 | 9 |
| 15 | 19.0 | .9 | 4.6 | 9 |
| 16 | 30.5 | 1.6 | 5.2 | 6 |
| 17 | 34.3 | 5.2 | 15.0 | 6 |
| NBS-A ^a | 32.4 | 1.8 | 5.6 | 27 |
| NBS-B ^b | 28 | 2 | 7.1 | 105 |

^aSee footnote m in table 5a.

^bSee footnote d in table 5a.

Table 5a. Summary of methods and conditions used at cooperating laboratories.

SRM 1092 - Vacuum Melted Steel

| Lab. | Method | Temperature °C | Collection time (min.) | Weight of sample (g) | Bath |
|-------|-------------------------------|-------------------|------------------------------|-------------------------------|-------------------|
| 1 | Vacuum fusion ^a | 1650 | 30 | 2 | None |
| 2 | Vacuum fusion | 1650 | -- | 1.0-1.5 | None |
| 3 | Inert gas fusion ^b | 2350 | 6 | 0.4-0.7 | Pt ^c |
| 4 | Vacuum fusion | 1650 | 15 | 1.0 | Fe |
| 5 | Vacuum fusion | 1650 | -- | 3.0 | Fe |
| 6 | No information available | | | | |
| 7 | Vacuum fusion ^d | 1700 | 3 | 1.5 | Ni-Fe |
| 8 | Inert gas fusion ^b | 2000 | -- | 2.5 | None |
| 9 | Vacuum fusion ^e | 1800 | 5 | 1.0-1.4 | Pt ^f |
| 10 | Vacuum fusion | 1700-1800 | 10 | 2.5 | None |
| 11 | Vacuum fusion | 1650 | 20 | 2.4-2.8 | Fe ^g |
| 12 | Vacuum fusion ^h | 1650 ⁱ | 20 | 1-2 | Fe |
| 13 | Vacuum fusion ^h | 1850 | 20 | 1 | Fe |
| 14 | Vacuum fusion ^h | 1650 | -- | 1.6-2.0 | None |
| 15 | Vacuum fusion | 1950 | 5 | 0.5 | Pt ^j |
| 16 | Vacuum fusion ^h | 1830-1920 | 15 | 1.1-1.8 | None ^k |
| 17 | Vacuum fusion ^l | 1650 | 15 | 1.0 | Fe |
| NBS-A | Vacuum fusion ^m | 1650 | 20 | 2.5 | None |
| NBS-B | Vacuum fusion ^d | 1650 | 4 | 2.0 | Ni ⁿ |

^aConstructed in laboratory.

^bLeco.

^cPt: sample = 6:1.

^dB.B. Exhalograph EA-1.

^eUsed model 21-610 mass spectrometer for analysis of gases.

^fPt: sample = 1.3:1.

^gFive grams Fe.

^hNRC.

ⁱPt bath at 1950-2000 used for one specimen.

^j2.5 g Pt degassed before each sample is added.

^kTin added intermittently.

^lSerfass analyzer

^mNRC-modified for fractional freezing.

ⁿApproximately 7 grams Ni bath used.

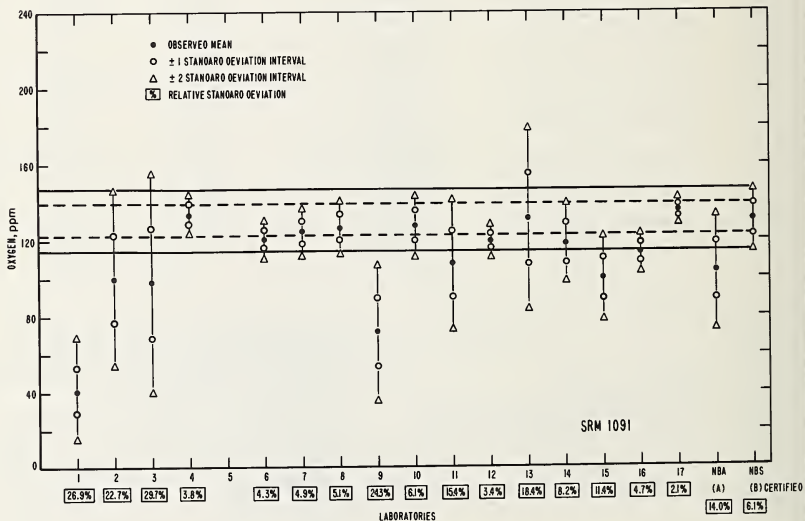
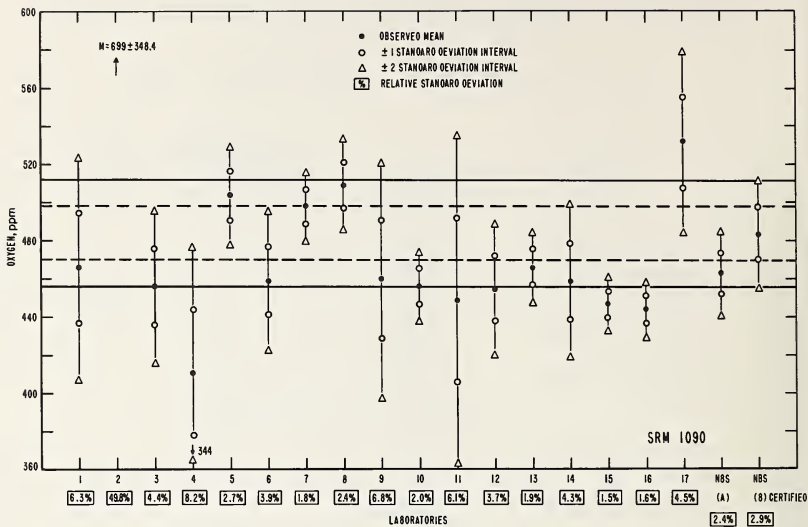

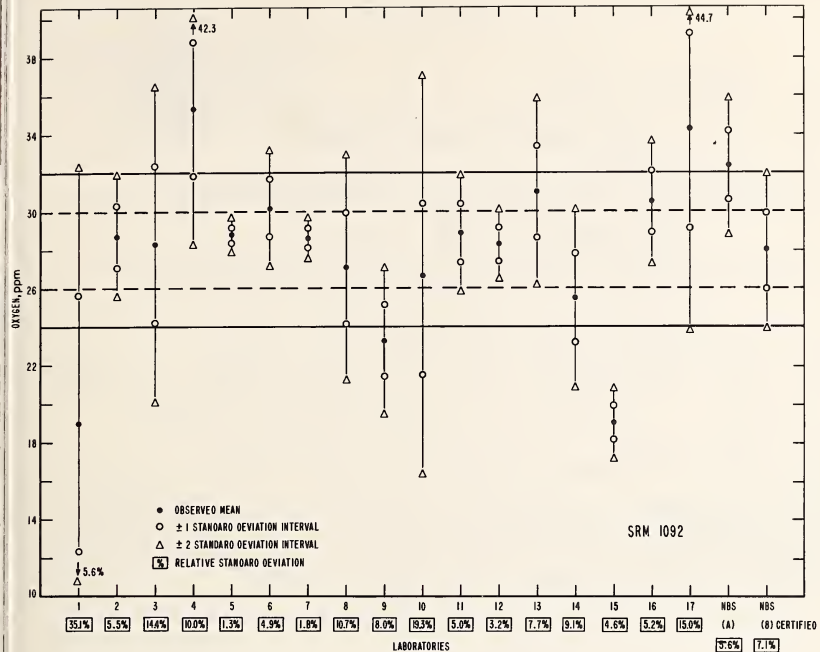

Figure 8. Summary of precision and accuracy of cooperating laboratories for SRM 1090, 1091 and 1092.

6. REFERENCES

- [1] Jordan, L., Eckman, J. R., Ind. and Eng. Chem. 18, 279-282 (1926).
- [2] Oberhoffer, P. Von, Schenck, H., Stahl u. Eisen 47, 1526 (1927).
- [3] Thompson, J. G., Vacher, H. C., Bright, H. A., J. of Res. NBS 18, 259 (1937).
- [4] Sloman, A. A., Harvey, C. A., J. Inst. Metals 80, 391 (Appendix - O. Kubasekewski.) (1952).
- [5] Smiley, W. W., Anal. Chem. 27, 1098 (1955).
- [6] Kraus, Von Thaddaus, Arch. Eisenhüttenw. 33, 527 (1962).
- [7] James, J. A., Metallurgical Reviews 9, 93 (1964).
- [8] Harris, William F., Talanta 11, 1376 (1964).
- [9] Winge, R. K. and Fassel, V. A., Anal. Chem. 37, 67 (1965).
- [10] Walter, D. I., Anal. Chem. 22, 297 (1950).



Certificate of Analysis

Standard Reference Materials 1090, 1091, 1092

Oxygen in Ferrous Materials

(By Vacuum and Inert Gas Fusion Methods)

| No. | Type | Oxygen, ppm | Uncertainty, ppm ^d |
|------|---|------------------|-------------------------------|
| 1090 | Ingot Iron ^a | 484 ^e | 14 |
| 1091 | Stainless Steel (AISI 431) ^b | 131 ^f | 8 |
| 1092 | Vacuum Melted Steel ^c | 28 ^g | 2 |

Size: 1090, rods $\frac{1}{4}$ in. in diameter and 4 in. long; 1091, rods $\frac{5}{16}$ in. in diameter and 4 in. long; 1092, rods $\frac{1}{4}$ in. in diameter and 4 in. long.

^a Determination on 0.5g sample.

^b Determination on 0.75g sample.

^c Determination on 2g sample.

^d Standard deviation (1-sigma). These values include variations in the precision of the method, as well as differences which may be due to any inhomogeneity of the material.

^e This value, obtained at NBS, is the average of 216 determinations on 54 rods. An average value of 487 parts per million was obtained by 18 cooperating laboratories. Of the 18 laboratories reporting, 7 were within the 2-sigma limit, 15 within the 3-sigma limit and 3 were outside the 3-sigma limit.

^f This value, obtained at NBS, is the average of 286 determinations on 167 rods. An average value of 126 parts per

million was obtained by 10 cooperating laboratories. Of the 10 laboratories reporting, 9 were within the 2-sigma limit and all were within the 3-sigma limit.

^g This value, obtained at NBS, is the average of 105 determinations on 105 rods. An average value of 29 parts per million was obtained by 13 cooperating laboratories. Of the 13 laboratories reporting, 12 were within the 2-sigma limit and all were within the 3-sigma limit.

CAUTION: Oxygen determinations should be made on thoroughly and freshly cleaned samples that represent the full cross-section of the rods.

List of Analysts

- J. T. Sterling, F. J. Palumbo, and O. Menis, Division of Analytical Chemistry, Institute for Materials Research, National Bureau of Standards.
- L. M. Melnick, J. F. Martin, and R. Rapp, Applied Research Laboratory, United States Steel Corp., Monroeville, Pa.
- W. F. Harris, Research and Development Center, Westinghouse Electric Corp., Pittsburgh, Pa.
- L. A. De Aeth, Technology Department, Union Carbide Metals Co., Niagara Falls, N. Y.
- M. K. Weiss, Research Center, Republic Steel Corp., Cleveland, Ohio.
- D. E. Walschlaeger, A. O. Smith Corp., Milwaukee, Wis.
- S. Vigo and F. P. Valenti, U. S. Army Materials Research Agency, Watertown, Mass.
- W. F. Harris, The Youngstown Sheet and Tube Co., Youngstown, Ohio.
- D. L. Smith, Bettis Atomic Power Laboratory, Westinghouse Electric Corp., Pittsburgh, Pa.
- D. W. Murphy, Bethlehem Steel Co., Bethlehem, Pa.
- M. F. Quaely, Lamp Division, Westinghouse Electric Corp., Bloomfield, N. J.
- R. F. Dufour, Knolls Atomic Power Laboratory, General Electric Co., Schenectady, N. Y.
- C. C. Carson, Large Steam Turbine-Generator Department, Materials and Processes Laboratory, General Electric Co., Schenectady, N. Y.
- C. H. Albright, Research Laboratory, The International Nickel Company, Inc., Sterling Forest, Suffern, N. Y.
- M. W. Mallett, Battelle Memorial Institute, Columbus, Ohio.
- J. P. Martin, National Research Corp., Cambridge, Mass.
- D. P. Bartell, Allegheny-Ludlum Steel Corp., Brackenridge Works, Brackenridge, Pa.
- L. Pasztor, Graham Research Laboratory, Jones and Laughlin Steel Corp., Pittsburgh, Pa.
- H. J. Schmitt and G. Helling, Laboratory Equipment Corp., St. Joseph, Mich.
- R. L. Rudolph, Crucible Steel Company of America, Midland Works, Midland, Pa.

Washington, D. C.
 March 1, 1966

W. Wayne Meinke, Chief
 Office of Standard Reference Materials

SUPPLEMENTARY INFORMATION

OTHER ELEMENTS: Although not certified at this time, nitrogen was determined by a distillation-photometric method, with the following results:

| No. | Nitrogen, ppm |
|-----------|---------------|
| 1090..... | 63 |
| 1091..... | 865 |
| 1092..... | 10 |

PREPARATION FOR THE DETERMINATION OF OXYGEN:

1. Samples should be cut from the original rod in such a manner as to minimize heating of the sample; i.e., by a hand hacksaw.
2. All surfaces of the cut sample should be thoroughly cleaned with a fine file.
3. Samples should be washed with C.P. ether, acetone, or other suitable solvent, dried in a stream of warm clean air and then handled only with clean forceps.
4. Analyses should be made as soon as possible after cleaning the sample.

CONDITIONS FOR ANALYSIS AT NBS:

| | |
|------------------------------------|-------------------------|
| Method..... | Vacuum fusion |
| Furnace temperature..... | 1675 °C. |
| Furnace pressure..... | <10 ⁻⁵ Torr. |
| Collection time..... | 4 mins. |
| Bath material..... | High-purity nickel |
| Carbon monoxide determination..... | Infrared absorption |

When these conditions are used, together with the certified values, the three Standard Reference Materials plot to a straight-line analytical curve.

A complete report on the testing and analysis of these materials will be published in the NBS Misc. Publ. 260 Series.

The material for these Standards was furnished to NBS by Armco Steel Corp., Jones and Laughlin Steel Corp., and U. S. Steel Corp.

Announcement of New Publications on
Standard Reference Materials

Superintendent of Documents
Government Printing Office
Washington, D. C. 20402

Dear Sir:

Please add my name to the announcement list of new publications to be issued in the series: NBS Miscellaneous Publication 260 - Standard Reference Materials.

Name _____

Company _____

Address _____

City _____ State _____ Zip Code _____

(Notification key N-330)

(cut here)

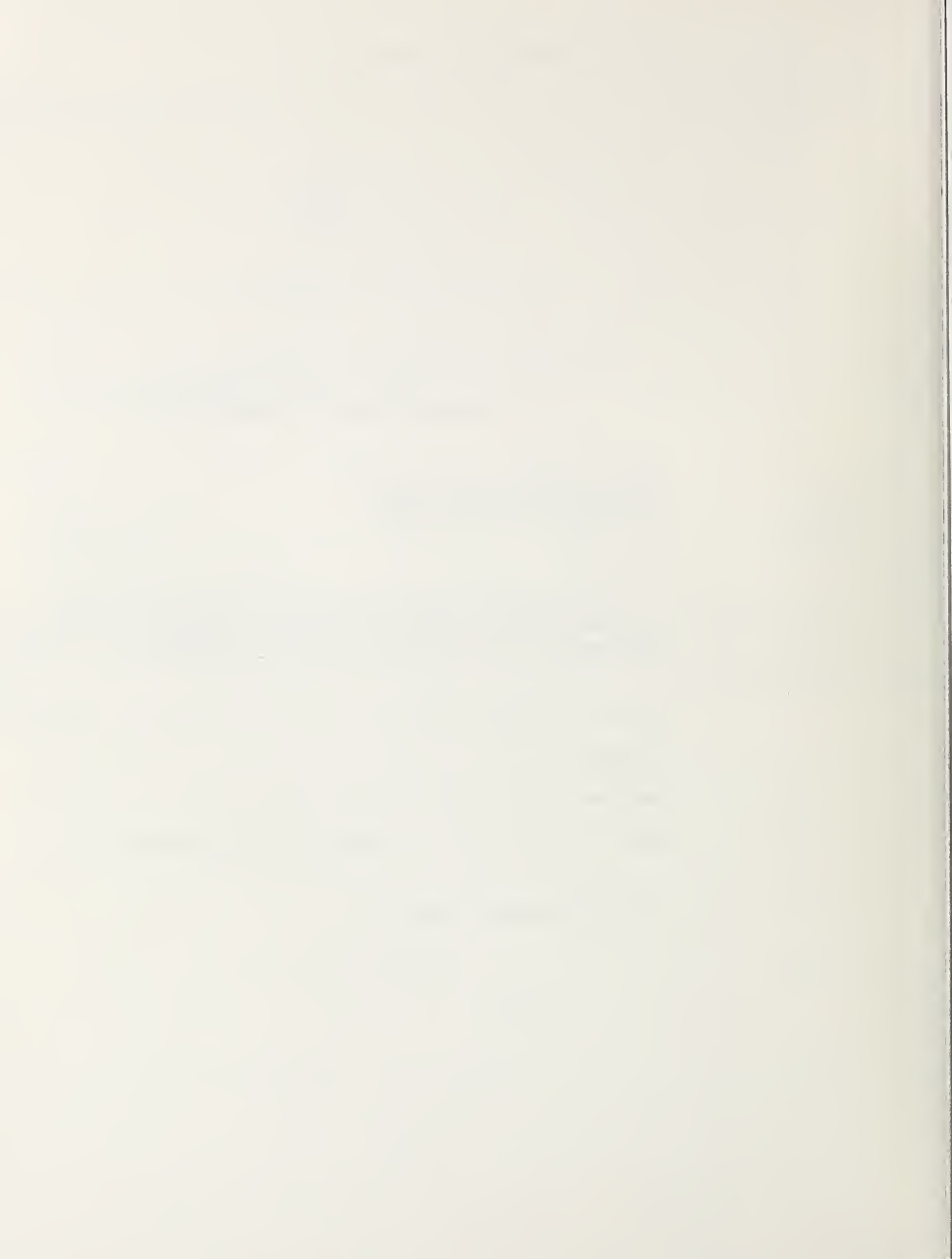

Announcement of New Publications on
Standard Reference Materials

Superintendent of Documents
Government Printing Office
Washington, D. C. 20402

Dear Sir:

Please add my name to the announcement list of new publications to be issued in the series: NBS Miscellaneous Publication 260 - Standard Reference Materials.

Name _____

Company _____

Address _____

City _____ State _____ Zip Code _____

(Notification key N-330)

(cut here)

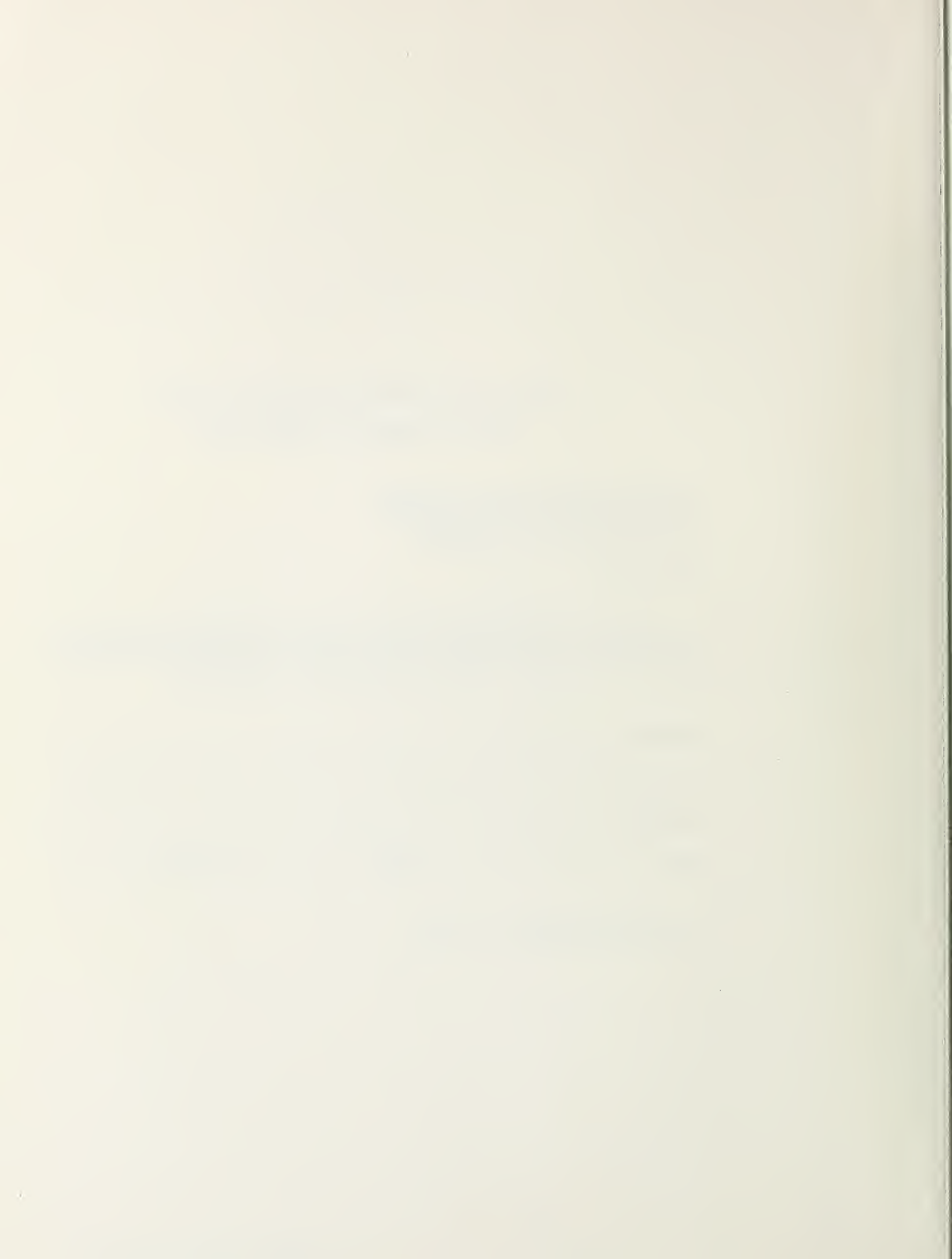



U.S. DEPARTMENT OF COMMERCE
WASHINGTON, D.C. 20230

POSTAGE AND FEES PAID
U.S. DEPARTMENT OF COMMERCE

OFFICIAL BUSINESS
