

NBS MISC. PUBL. 260-13

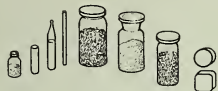

STANDARD REFERENCE MATERIALS:

**MOSSBAUER SPECTROSCOPY STANDARD FOR
THE CHEMICAL SHIFT OF IRON COMPOUNDS**



**U.S. Department of Commerce
National Bureau of Standards**

QC
100
457
260-13
1467
Copy 2

THE NATIONAL BUREAU OF STANDARDS

The National Bureau of Standards¹ provides measurement and technical information services essential to the efficiency and effectiveness of the work of the Nation's scientists and engineers. The Bureau serves also as a focal point in the Federal Government for assuring maximum application of the physical and engineering sciences to the advancement of technology in industry and commerce. To accomplish this mission, the Bureau is organized into three institutes covering broad program areas of research and services:

THE INSTITUTE FOR BASIC STANDARDS . . . provides the central basis within the United States for a complete and consistent system of physical measurements, coordinates that system with the measurement systems of other nations, and furnishes essential services leading to accurate and uniform physical measurements throughout the Nation's scientific community, industry, and commerce. This Institute comprises a series of divisions, each serving a classical subject matter area:

—Applied Mathematics—Electricity—Metrology—Mechanics—Heat—Atomic Physics—Physical Chemistry—Radiation Physics—Laboratory Astrophysics²—Radio Standards Laboratory,³ which includes Radio Standards Physics and Radio Standards Engineering—Office of Standard Reference Data.

THE INSTITUTE FOR MATERIALS RESEARCH . . . conducts materials research and provides associated materials services including mainly reference materials and data on the properties of materials. Beyond its direct interest to the Nation's scientists and engineers, this Institute yields services which are essential to the advancement of technology in industry and commerce. This Institute is organized primarily by technical fields:

—Analytical Chemistry—Metallurgy—Reactor Radiations—Polymers—Inorganic Materials—Cryogenics²—Office of Standard Reference Materials.

THE INSTITUTE FOR APPLIED TECHNOLOGY . . . provides technical services to promote the use of available technology and to facilitate technological innovation in industry and government. The principal elements of this Institute are:

—Building Research—Electronic Instrumentation—Technical Analysis—Center for Computer Sciences and Technology—Textile and Apparel Technology Center—Office of Weights and Measures—Office of Engineering Standards Services—Office of Invention and Innovation—Office of Vehicle Systems Research—Clearinghouse for Federal Scientific and Technical Information³—Materials Evaluation Laboratory—NBS/GSA Testing Laboratory.

¹ Headquarters and Laboratories at Gaithersburg, Maryland, unless otherwise noted; mailing address Washington, D. C., 20234.

² Located at Boulder, Colorado, 80302.

³ Located at 5285 Port Royal Road, Springfield, Virginia 22151.

UNITED STATES DEPARTMENT OF COMMERCE
Alexander B. Trowbridge, *Secretary*
NATIONAL BUREAU OF STANDARDS • A. V. ASTIN, *Director*

Standard Reference Materials:

Mossbauer Spectroscopy Standard for the Chemical Shift of Iron Compounds

Jon J. Spijkerman, David K. Snediker, Fillmer C. Ruegg,
and James R. DeVoe

Institute for Materials Research
National Bureau of Standards
Washington, D.C. 20234



National Bureau of Standards Miscellaneous Publication 260-13

Issued July 28, 1967

Library of Congress Catalog Card Number: 67-60030

PREFACE

Within the framework of the NBS Institute for Materials Research the area of standard reference materials is a broad and important one, including the preparation, characterization and distribution of a wide variety of materials in such diverse fields as metallurgy, polymers and inorganic materials. In carrying out such a program there is much interaction with representatives of industry and science, beginning with discussions as to which primary standard materials will do most to advance technology, the furnishing of materials and fabrication of samples, and the characterization and certification of the materials by cooperative efforts. The many groups participating in a standards program are very interested in detailed information on specific aspects of the program -- but to date there has been no publication outlet for such written discussions.

To meet this need, NBS Miscellaneous Publication 260 has been reserved for a series of papers in the general area of "standard reference materials". This series will present the results of studies and investigations undertaken within the Institute for Materials Research with emphasis on the preparation and characterization of standard reference materials. This subject-oriented series will provide a means for rapid dissemination of this detailed information and we hope will stimulate the use of standard reference materials in science and industry.

W. Wayne Meinke, Chief
Office of Standard Reference Materials

OTHER NBS PUBLICATIONS IN THIS SERIES

- NBS Misc. Publ. 260, Standard Reference Materials: Catalog and Price List of Standard Materials Issued by the National Bureau of Standards, October 1965. 45 cents.* (Supersedes NBS Misc. Publ. 241, March 1962.)
- NBS Misc. Publ. 260-1, Standard Reference Materials: Preparation of NBS White Cast Iron Spectrochemical Standards, June 1964. 30 cents.*
- NBS Misc. Publ. 260-2, Standard Reference Materials: Preparation of NBS Copper-Base Spectrochemical Standards, October 1964. 35 cents.*
- NBS Misc. Publ. 260-3, Standard Reference Materials: Metallographic Characterization of an NBS Spectrometric Low-Alloy Steel Standard, October 1964. 20 cents.*
- NBS Misc. Publ. 260-4, Standard Reference Materials: Sources of Information on Standard Reference Materials, February 1965. 20 cents.*
- NBS Misc. Publ. 260-5, Standard Reference Materials: Accuracy of Solution X-Ray Spectrometric Analysis of Copper-Base Alloys, March 1965. 25 cents.*
- NBS Misc. Publ. 260-6, Standard Reference Materials: Methods for the Chemical Analysis of White Cast Iron Standards, July 1965. 45 cents.*
- NBS Misc. Publ. 260-7, Standard Reference Materials: Methods for the Chemical Analysis of NBS Copper-Base Spectrochemical Standards, October 1965. 60 cents.*
- NBS Misc. Publ. 260-8, Standard Reference Materials: Analysis of Uranium Concentrates at the National Bureau of Standards, December 1965. 55 cents.*
- NBS Misc. Publ. 260-9, Standard Reference Materials: Half Lives of Materials Used in the Preparation of Standard Reference Materials of Nineteen Radioactive Nuclides Issued by the National Bureau of Standards, November 1965. 15 cents.*
- NBS Misc. Publ. 260-10, Standard Reference Materials: homogeneity Characterization of NBS Spectrometric Standards II: Cartridge Brass and Low-Alloy Steel, December 1965. 30 cents.*
- NBS Misc. Publ. 260-11, Standard Reference Materials: Viscosity of a Standard Lead-Silica Glass. November 1966. 25 cents.*

NBS Misc. Publ. 260-12, Standard Reference Materials: Homogeneity Characterization of NBS Spectrometric Standards III: White Cast Iron and Stainless Steel Powder Compact. September 1966. 20 cents.*

NBS Misc. Publ. 260-14, Standard Reference Materials: Determination of Oxygen in Ferrous Materials SRM 1090, 1091, and 1092. September 1966. 30 cents.*

*Send orders with remittance to: Superintendent of Documents, U. S. Government Printing Office, Washington, D. C. 20402. Remittance from foreign countries should include an additional one-fourth of the purchase price for postage.

TABLE OF CONTENTS

	PAGE
1. INTRODUCTION	1
2. PREPARATION AND DESCRIPTION OF THE STANDARD . . .	4
Preparation	4
Chemical Description	4
Physical Description	5
Electronic Structure	7
3. MOSSBAUER SPECTROSCOPY MEASUREMENTS	8
Description of Equipment	8
Measurement of Mossbauer Spectrum Parameters . . .	11
Chemical Shift	11
Electric Quadrupole Splitting	11
Linewidth	12
Magnitude of Resonance Effect	12
Gamma Ray Attenuation	12
Computations	12
4. ANALYSIS OF RANDOM AND SYSTEMATIC ERRORS	13
Random Errors in the Calibration Procedure	13
Optical Spectrometer Drift	15
Counting Statistics	16
Systematic Error in the Determination of the Electric Quadrupole Splitting	16
Summary	17
5. THE USE OF THE STANDARD	18
Procedure for Measuring Chemical Shift and Reporting Differential Chemical Shift	18
6. SUMMARY	19
7. ACKNOWLEDGMENTS	20
8. REFERENCES	23
APPENDIX A - COMPUTER CURVE FITTING FOR MOSSBAUER SPECTRA	26
APPENDIX B - ANGULAR DISTRIBUTION OF RADIATION IN THE MOSSBAUER EFFECT	33

TABLE OF CONTENTS (Con't)

	PAGE
APPENDIX C - FORMAT FOR PRESENTATION OF EXPERIMENTAL MOSSBAUER SPECTRA AND PARAMETERS	37
APPENDIX D - PHYSICAL CONSTANTS AND CONVERSION FACTORS FOR IRON-57 MOSSBAUER SPECTROSCOPY	43
APPENDIX E - ATTENUATION AND LINE BROADENING FOR ⁵⁷ FE ABSORBERS	45

LIST OF FIGURES

FIGURE NO.

1. Chemical shift of sodium nitroprusside for different source matrices	2
2. Single crystal of sodium nitroprusside, show- ing habit and orientation of platelet	6
3. Photograph of single crystal of sodium nitro- prusside with platelet shown in proper orientation	6
4. X-ray stereographic projection of sodium nitro- prusside single crystal along the 001 axis	7
5. Optical system for accurate measurement of velocity	9
6. Peak intensity assymetry for the $\pm 3/2$ $\pm 1/2$ doublet in iron compounds as a function of the angle between the electric field gradient and the incident radiation	36
7. Attenuation coefficients for 14.4 keV gamma radiation as a function of element	46
8. Plot of effective source thickness	47

MOSSBAUER SPECTROSCOPY STANDARD
FOR CHEMICAL SHIFT OF IRON COMPOUNDS

Jon J. Spijkerman, David K. Snediker,
Fillmer C. Ruegg, and James R. DeVoe

Institute for Materials Research
National Bureau of Standards

ABSTRACT

The preparation, calibration, and use of the Standard Reference Material for chemical shift of iron compounds in Mossbauer Spectroscopy is described. This standard is a properly oriented single crystal of sodium pentacyanonitrosylferrate(II) dihydrate (sodium nitroprusside). Primary standards were calibrated with a high accuracy optical Mossbauer spectrometer and secondary calibrations were made with a tandem Mossbauer spectrometer. The midpoint between the two absorption peaks in the spectrum at 25.0 °C provide a useful velocity scale calibration of the spectrometer. Descriptions of the spectrometers used and the error analysis associated with the data are given. Suggested format for reporting Mossbauer spectra and their parameters is also presented.

Key words: Mossbauer, Spectroscopy, standard, differential chemical shift, quadrupole splitting, random error, systematic error, sodium nitroprusside, iron compounds, optical Mossbauer spectrometer, tandem Mossbauer spectrometer, velocity calibration.

1. INTRODUCTION

While the Mossbauer effect was first used to resolve a number of problems in physics it has now found a definite application in chemical structure analysis. The importance of Mossbauer spectroscopy to chemical structural analysis was recognized in 1962 but received little attention until 1964. The early efforts made to explain the parameters obtained in Mossbauer spectroscopy were qualitative or at most in a semi-quantitative sense. Only since 1965 have attempts been made to be quantitative. Such attempts have brought about realization of a serious shortcoming with data published in scientific periodicals. The Mossbauer chemical shift for a given series of compounds is rarely reported with respect to the same source (see figure 1). Consequently, normalization of data taken by different laboratories is necessary. One additional difficulty has been found. Even if the source used in two different laboratories is nominally the same, serious discrepancies occur in the chemical shift reported. This presumably is a consequence of the method of preparation of the sources which usually are made by diffusing a radioisotope into a metal substrate. Proper annealing is very important and doing this reproducibly to give the same structural environment is difficult.

The most practical solution is to measure the chemical shift of an unknown compound with respect to a reference compound. This was anticipated by the attendees of a symposium on Mossbauer Effect at the 1964 Gordon Research Conference on inorganic chemistry. The compound sodium pentacyanonitrosylferrate(II) dihydrate (sodium nitroprusside) was suggested at this conference. Other materials were also suggested. A particularly interesting one appeared to be iron foil, but studies at NBS have indicated that its reproducibility with respect to both production of the standard and stability of

its structure was unsatisfactory [1, 2]. The evaluation of sodium nitroprusside as a Standard Reference Material for chemical shift which is described in this report proved that it is a suitable standard.

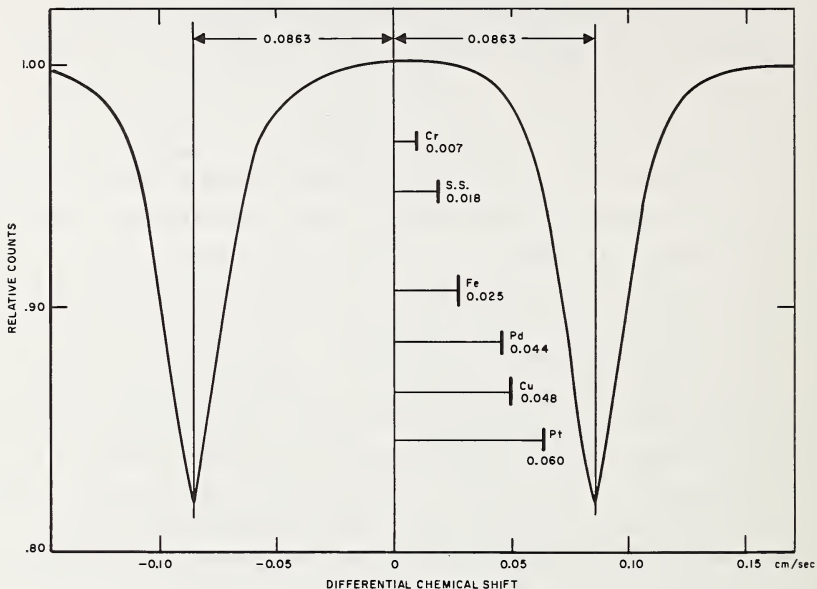

Figure 1. Chemical shift of sodium nitroprusside for different source matrices.

It was necessary to develop a philosophy for the production and calibration of this standard which would maintain its usefulness during the foreseeable future. The system decided upon is like that of many of the standards developed at NBS. Ten primary standards were made from the best obtainable single crystal of sodium nitroprusside. These crystals were then calibrated with a spectrometer that has very high accuracy and precision. Fifty standards were then randomly sam-

pled from a lot of 500. The sample of fifty was then calibrated against the primary standards using the NBS tandem spectrometer. The ten primary standards will be measured periodically with the high accuracy spectrometer to detect any possible changes in the chemical shift as a function of time. Any subsequent lots of standards will be calibrated against the ten primary standards. In addition, if standards for compounds other than those containing iron should be desired, these standard reference materials would be calibrated against the primary standard for iron.

This report describes the theory and procedures for calibration and use of the Standard Reference Material for chemical shift of iron compounds. It has not been found practicable to include all of the detail on the single crystal preparation, on the Mossbauer spectrometers, or on the computer programs used to resolve the spectra. Pertinent references on these subjects are given.

It is important that this new and powerful spectroscopy receive the benefit of standardization so that the spectrum parameters can be used with confidence. In conjunction with this, a format for reporting Mossbauer spectra and for reporting spectrum parameters along with their nomenclature is suggested.

2. PREPARATION AND DESCRIPTION OF THE STANDARD

A. Preparation

Sodium nitroprusside, $\text{Na}_2[\text{Fe}(\text{CN})_5\text{NO}] \cdot 2\text{H}_2\text{O}$, is prepared by the action of 30% (vol) nitric acid on sodium ferrocyanide or ferricyanide [3], or by the reaction of nitride ion on either sodium ferrocyanide or ferricyanide in acid solution [4,5,6].

Single crystals were grown from a saturated aqueous solution of ACS reagent grade material [7] at a pH of 6.5 - 6.8, using glass equipment. Thin platelets 1 cm x 1 cm x .078 cm were cut from the single crystals. The platelets were cut with a string saw along the 100 plane within $\pm 2^\circ$. The required thickness of 0.0775 ± 0.0030 cm with a parallelism within 0.001 mm and a surface finish of 20 microns was achieved by polishing the platelets. A stock of 500 platelets was produced by the Isomet Corporation for the NBS standard [8].

B. Chemical Description

Sodium nitroprusside is stable at room temperature under normal laboratory conditions [9]. The compound with two water molecules of hydration is stable up to 100°C . At higher temperatures (near 450°C), the salt is transformed [10] to sodium ferrous ferrocyanide, sodium ferrocyanide, nitric oxide and cyanogen. At higher temperatures, nitrogen is evolved. To determine the stability of the standard reference crystal in a laboratory atmosphere, a platelet was exposed for a prolonged period of time. The relative humidity was 50-70% and the temperature $25 \pm 2^\circ\text{C}$. No change in weight of the platelet was observed within 10^{-4} g after a six month period. For stability with respect to the Mossbauer spectrum, see section 3.

The solid salt is stable in air, but the solutions are not [11]. In alkaline solutions [3,12] the salt is converted into pentacyanonitritoferrate (II), and in acid solution hydrocyanic acid is liberated at high concentrations. The solubility of the salt is 40 mg/100 ml H_2O at 16°C [13] and

57 mg/100 ml at 43°C [8]. The salt transforms slowly in direct sunlight [14] to $\text{Fe}_7(\text{CN})_{18}$, NO and Prussian blue.

The specification for reagent grade sodium nitroprusside is as follows [7]:

Sodium nitroprusside, $\text{Na}_2[\text{Fe}(\text{CN})_5\text{NO}] \cdot 2\text{H}_2\text{O}$, Formula
Wt. 297.97

Insoluble matter: Not more than 0.010%

Chloride (Cl^-): Not more than 0.020%

Sulfate (SO_4): To pass test (limit about 0.01%).

Microchemical analysis on three single crystals taken at random was performed at NBS, with the results [15]:

Iron	$18.74 \pm 0.05\%*$
Carbon	$20.2 \pm 0.3\%$
Hydrogen	$1.4 \pm 0.1\%$
Nitrogen	$28.0 \pm 0.3\%$

The analyses confirm that the theoretical composition may be used in any calculations required with this material.

C. Physical Description

The salt crystallizes in deep red orthorhombic crystals, belonging to the space group $D_{2h}^{12} - \text{Pmmn}$. The cell constants, for four formula weights per unit cell, are [15]:

$$a = 6.17 \pm 0.03 \text{ \AA}$$

$$b = 11.84 \pm 0.06 \text{ \AA}$$

$$c = 15.43 \pm 0.08 \text{ \AA}$$

The x-ray density [17] is 1.76 g/cm^3 , a figure which is in agreement with the macroscopic determination [18] of $1.72 \pm 0.02 \text{ g/cm}^3$.

The faces are the (110) primary rhombic prism, the (010) primary brachy-pinakoid and the (011) primary brachydomal prism. The platelets are cut along the 100 plane as shown in figure 2 and 3, in the x-ray stereographic projection shown in figure 4.

* Unless otherwise specified, all error limits are standard deviations of a single observation.

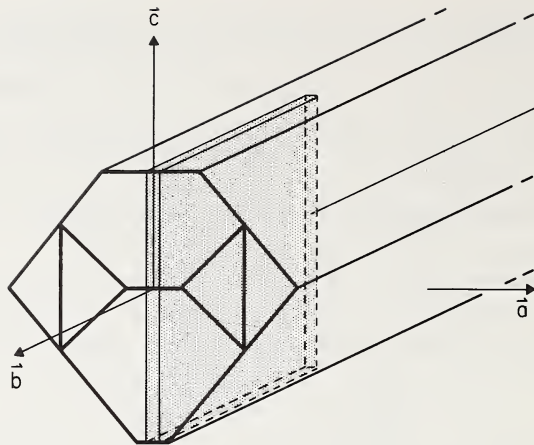

Figure 2. Single crystal of sodium nitroprusside, showing habit and orientation of platelet.

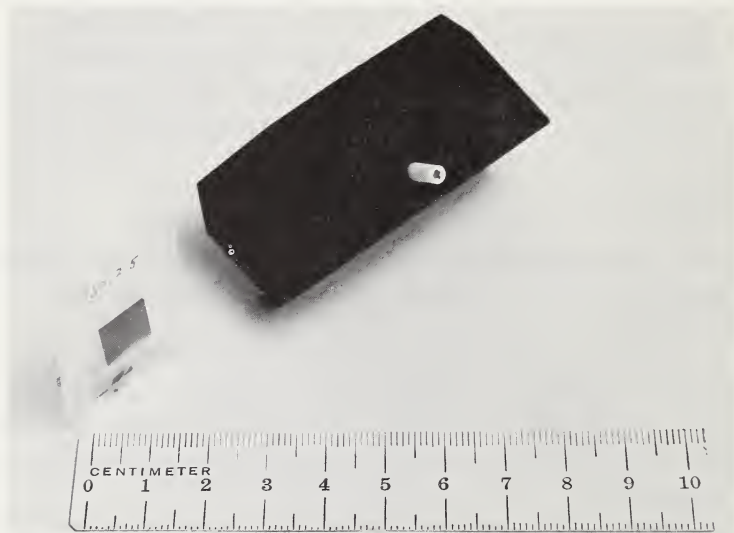

Figure 3. Photograph of single crystal of sodium nitroprusside with platelet shown in proper orientation.

D. Electronic Structure

The bonding in the nitroprusside anion has been described by Manoharan and Gray [19] in terms of molecular orbital theory with the configuration $3d^{6.983} 4s^{0.449} 4p^{0.251}$. The 44.9% 4s character differs with the 60% 4s character obtained from the Walker, Wertheim, Jaccarino plot [20]. This discrepancy is under current investigation in several laboratories [20,21,22].

The quadrupole splitting is consistent with the assignment of a low spin $3d^6$ configuration for Fe(II). From the asymmetry of the intensity of the 2 transitions, $\uparrow 3/2 \rightarrow \uparrow 1/2$, $\uparrow 1/2 \rightarrow \uparrow 1/2$, the electric field gradient is axially symmetric and positive in sign [23] (see Appendix B).

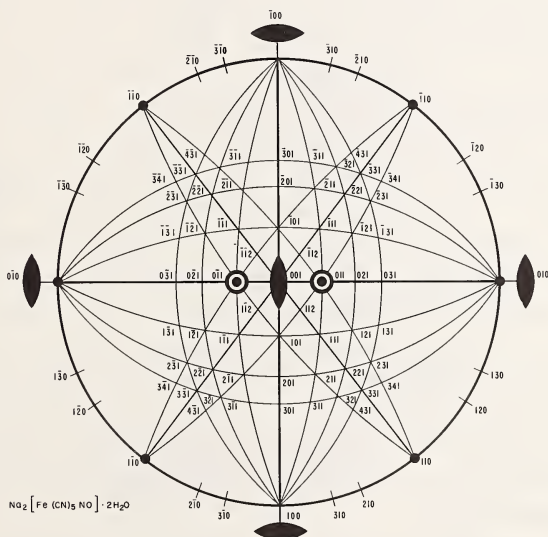

Figure 4. X-ray stereographic projection of sodium nitroprusside single crystal along the 001 axis.

3. MOSSBAUER SPECTROSCOPY MEASUREMENTS

A. Description of Equipment

For the calibration of the standard two types of Mossbauer spectrometers were used: the tandem spectrometer, using a multiplex technique for inter-comparison of the platelets, and a high accuracy spectrometer using an optical interferometer for the velocity measurements.

The tandem spectrometer operates in the constant acceleration mode. The Doppler velocity is generated by an electro-mechanical transducer, using a loudspeaker to produce the motion, that is mechanically coupled to a velocity sensor incorporated in a feedback loop. The spectrum is accumulated in a multi-channel analyzer operating in a multiscaler mode [24]. The analog voltage signal, varying linearly with time in a saw tooth fashion, is taken from the address scaler to provide the input signal for the transducer. This method guarantees synchronization of the Doppler drive velocity with the channel number of the analyzer. In order to improve the accuracy of the spectrometer, two spectra are accumulated simultaneously (multiplex). The Doppler velocity that is used for both source-absorber combinations is provided by one electromechanical drive unit [25]. For the calibration, the standard platelets were compared with the primary standard in the multiplex system. Cobalt-57 in a two mil palladium matrix (0.25 in diameter) was used for the source. The 14.4 keV radiation was detected by a gas flow proportional counter, using a 10% methane, 90% argon (P-10) gas mixture. A moving source geometry was used, with a 0.125 in aperture, in order to reduce any error due to the cosine effect [27].

The systematic error with respect to velocity of the above-described spectrometer is usually not within the attainable limits of random error. Since it is desirable to use the standard for calibration of Doppler velocity as well as for chemical shift, a high-accuracy spectrometer was designed to measure

the quadrupole splitting of sodium nitroprusside. An interferometer can be used with minor modifications to measure the velocity directly in terms of the primary standards of length (green line of ^{198}Hg) and time (WWV NBS standard frequency), since velocity is determined by a measurement of distance and time.

The interferometer consists of a stationary light source, beam splitter, reflector, a movable second reflector, and a photomultiplier (see figure 5). The light intensity produced by the interferometer varies sinusoidally with the optical path difference (ΔS) between the two reflectors.

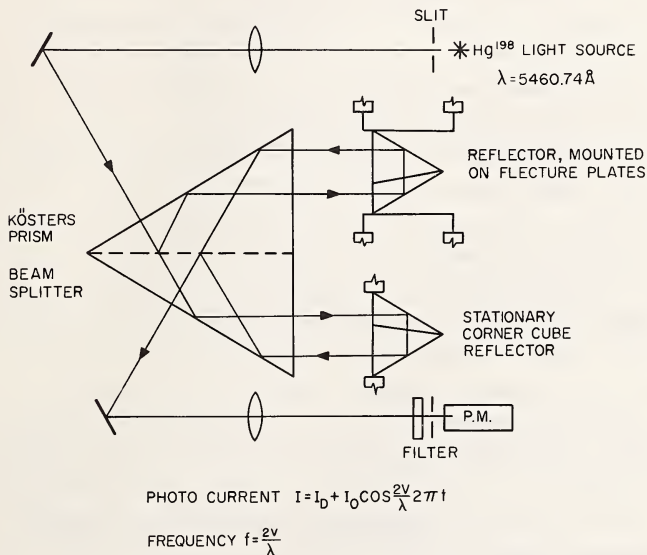

Figure 5. Optical system for accurate measurement of velocity.

The current produced by the photomultiplier is represented by the equation:

$$I(\Delta S) = I_D + I_0 \cos \frac{4\pi\Delta S}{\lambda}, \text{ where} \quad (1)$$

I_D = dark current

I_0 = signal current.

If the second reflector is not stationary, but moving with a velocity v , the photomultiplier current will be time dependent:

$$I(t) = I_D + I_0 \cos 2\pi \left(\frac{2v}{\lambda}\right)t, \text{ where} \quad (2)$$

$$\text{frequency} = \frac{2v}{\lambda}.$$

For a velocity of 1 mm/s, using the ^{198}Hg green line ($\lambda = 5460.74 \text{ \AA}$), this frequency corresponds to 3663.5 hertz. This interferometer thus allows velocity to be determined by a frequency measurement. To provide the feed-back signal for the electromechanical transducer, the fringe count frequency is compared with the driving frequency of a General Radio Company model 1162A synthesizer* (standardized against WWV) by means of a one to one frequency correlator [28]. With this arrangement, the velocity can be controlled and measured with high precision and accuracy. In this constant velocity mode, the spectrum of a primary standard was obtained by varying the frequency synthesizer through the range of 0 to 5 khertz in 100 hertz steps. Gating circuits were used to control the fringe and standard frequency counters for positive and negative velocities and to stop the radioactivity counting scalers during the spectrometer reversing interval. The detector system is identical to the one used in the constant acceleration mode. More detailed descriptions of this spectrometer appear in reference [29].

* The identification of commercial equipment in this paper does not imply recommendation or endorsement by the National Bureau of Standards; nor does it imply that the equipment identified is necessarily the best available for the purpose.

B. Measurement of Mossbauer Spectrum Parameters

From a lot of 500 platelets, 60 were randomly selected, and of the 60, ten were chosen as primary standards. The ten platelets were determined to be the best of the 60 by visual examination. After calibration of the primary standards with the optical spectrometer, one of the ten was selected for use as a comparator in the calibration of the 50 sample platelets. The platelet selected was determined to be the one closest to the average of the quadrupole splitting of the ten primary standards.

The spectrum parameters of chemical shift, quadrupole splitting, percent effect and linewidth were measured. All of these parameters were calculated with the mathematical technique described in Appeddix A.

1. Chemical Shift

The chemical shift of the sodium nitroprusside platelet measured with the incident radiation perpendicular to the 100 crystal plane, at 25.0°C is zero cm/s by definition, and is determined by the center of the doublet described below. The shift of an iron compound measured relative to sodium nitroprusside is called the differential chemical shift δ_o , while δ_{std} designates the chemical shift for the standard. The relationship for calculating differential chemical shift is

$$\delta_o = \delta_x - \delta_{std}$$

where δ_x is the chemical shift of the unknown compound. The temperature dependence of the chemical shift is $3 \times 10^{-5} \text{ cm s}^{-1} \text{ } ^\circ\text{K}^{-1}$ [30].

2. Electric Quadrupole Splitting

The nitrous ligand in sodium nitroprusside produces an electric field gradient at the iron nucleus, which results in the observed doublet spectrum [31]. The average quadrupole splitting, ΔE_Q , for the ten primary standard platelets has been determined to be $0.1726 \pm 0.0002 \text{ cm/s}$ at 25.0°C with a temperature dependence [30] of $10^{-5} \text{ cm s}^{-1} \text{ } ^\circ\text{K}^{-1}$.

For the 100 crystal plane, the doublet is symmetric energy [32] (Appendix B). A misalignment of 2 degrees in the 100 crystal plane of the standard from a perpendicular to the gamma ray produces an asymmetry of $S_p = 0.1$.

3. Linewidth

The linewidth (Γ) measured for the standard is 0.0305 ± 0.0004 cm/s. The effective absorber thickness for the 14.4 keV gamma radiation [33,34] is $T_a = 3.77$ mg/cm².

Corrections for cosine effect [32] were made. Using Margulies' method [33] the thick absorber line broadening is 1.51, yielding a corrected line width of 0.0202 ± 0.0004 cm/s (Appendix E). For powdered sodium nitroprusside with absorber thickness of 25 mg/cm² iron, the halfwidth is 5% larger than the theoretical width.

4. Magnitude of Resonance Effect

The standard absorber exhibits a percent effect (ϵ) of $17 \pm 2\%$ using 10 mCi ⁵⁷Co on a Pd matrix, with an argon-methane (P-10) gas flow proportional counter. The single channel analyzer was set to pass 98% of the 14.4 keV radiation.

5. Gamma Ray Attenuation

The attenuation of the crystal for 14.4 keV (0.864 Å) radiation is 85%, as determined using standard γ -spectrometric techniques. From Appendix E the attenuation can be seen to be due to the iron mass absorption.

C. Computations

Mossbauer spectra are particularly suited to resolution by mathematical methods. Machine digital computation is being used, hence errors in data manipulation are minimized and comprehensive random error estimates can be made of the spectrum parameters. The mathematical techniques used for resolving the Mossbauer spectra are described in Appendix A. An example of the output of the computer program called PARLORS IV is given in Appendix C.

4. ANALYSIS OF RANDOM AND SYSTEMATIC ERRORS

Since the chemical shift of this standard reference material is defined to be zero there is no systematic error associated with it. Therefore, systematic errors are associated only with the quadrupole splitting. Since we define the midpoint between two peaks of the spectrum of the standard as zero differential chemical shift, the random error in the quadrupole splitting reflects that associated with the measurement of the zero point for differential chemical shift. Ten primary standards were selected to be calibrated on the high accuracy optical spectrometer. The average quadrupole splitting of these ten results is the value reported on the certificate. The secondary standards were then calibrated from one of the primary standards with the use of the tandem spectrometer to determine the random error of both the quadrupole splitting and the zero point of differential chemical shift for the 50 samples that represent the lot of 500 platelets. The random errors in the chemical shift and quadrupole splitting are the standard deviations of a single determination.

A. Random Errors in the Calibration Procedure

Random errors resulted from the comparison technique and the optical spectrometer measurements. The random errors in the latter will be analyzed first.

For velocity measurements using the high accuracy spectrometer, the distance that the absorber traversed in a unit of time was determined. Since the Mossbauer transition takes place in a time interval of the order of 10^{-7} s, the unit of time for this measurement should be of this magnitude. An interferometric technique using visible light reduces the measurement of velocity to a frequency measurement. For this method the unit of length is the ^{198}Hg green line ($\gamma = 5460.74 \pm 0.01 \text{ \AA}$ corrected for air) [32]. By comparing the NBS standard frequency (accuracy of 1 part in 10^9) with the fringe-

count frequency generated by the interferometer using the ^{198}Hg green line the velocity can be measured. To evaluate the accuracy, the relationship between velocity and fringe-count frequency (f) is

$$v = \frac{\lambda f}{2} \quad (1)$$

since the optical path is twice the traverse of the spectrometer. The fractional error in velocity, $E(v)$, is given by:

$$E(v) = \left[E(\lambda)^2 + E(f)^2 \right]^{\frac{1}{2}}, \text{ where} \quad (2)$$

$$E(\lambda) = \text{fractional error in wave length} = 2 \times 10^{-6}$$

$$E(f) = \text{fractional error in frequency.}$$

The interferometer is capable of measurement to within $1/2$ fringe, therefore the fractional error in the frequency is given by:

$$E(f) = \frac{1}{2f} = \frac{1}{2} \left(\frac{\lambda}{2v} \right) = \frac{\lambda}{4v} \quad (3)$$

substituting into equation 2

$$E(v) = \left[4 \times 10^{-12} + \left(\frac{\lambda}{4v} \right)^2 \right]^{\frac{1}{2}} \quad (4)$$

for

$$v = 1 \text{ cm/s}$$

$$E(v) \cong 2 \times 10^{-6}$$

Equation (4) is an expression for the limiting random error. This expression also indicates that the interferometric method will not work at zero velocity because the error becomes infinite.

The above consideration does not take into account the limitations on the traverse of the spectrometer, due to visible light coherent path length and the inverse square law of radiation losses if long traverses are used.

Therefore, a more realistic estimate of the error can be obtained from the error in the fringe counts. Since the electronic circuitry is capable only of counting to the nearest

fringe, the error in velocity is then dependent upon the number of fringe pulses (f) per centimeter of travel (d).

$$f = \frac{d}{(\lambda/2)(1/2)} \quad (5)$$

The factor $1/2$ arises from the fact that the electronics count half-cycles. For the one centimeter distance of travel used in this work, equation (5) yields 8×10^4 fringe pulses. Hence the random error in velocity for one centimeter travel is one fringe pulse.

The above considerations assume the velocity correction circuitry to be capable of instant correction when a velocity error is sensed. However, the mass of the moving system reduces the correction time, which produces a random error if the velocity corrections are random, and a systematic error if the correction signs are largely positive or negative. This systematic error will be discussed below. The random error could only increase the line width determination, and the amount of increase in line width does not significantly increase the random error in the quadrupole splitting determination.

Since the tandem system was used, only the differential linearity (e.g., the line width divided by the separation of the doublet) is important. This differential linearity was found to contribute an insignificant amount to the total random error for the calibration measurements [24].

1. Optical Spectrometer Drift

The optical spectrometer drift would contribute the largest error in the calibration measurements, since this would be directly reflected in the random error of the chemical shift. Evaluation of the magnitude of this error by measuring one of the primary standards over a one month period indicated a standard deviation of the chemical shift of ± 0.02 cm/s from 50 measurements. However, by using the tandem spectrometer this error due to drift was reduced to a negligible amount.

2. Counting Statistics

Preliminary measurements on the sodium nitroprusside crystals, and the economics of data accumulation time dictated that a maximum of 5×10^5 counts per channel (N_c) for 200 channels be accumulated for each platelet. This would correspond to a standard deviation of a single determination of 10^{-4} cm/s due to counting statistics. This was further confirmed by the residuals obtained from a least squares fitting of the experimental data points to a Lorentzian line profile, discussed in Appendix A.

B. Systematic Error in the Determination of the Electric Quadrupole Splitting

The error in the velocity measurement is limited by the instrumentation, due to the resolution of the one to one frequency comparator and the time response of the system. The open loop gain as a function of frequency decreases 6 dB per octave and the signal-to-noise ratio limits the response to 300 hertz. The frequency correlator response time is inversely proportional to the frequency, but the response time can be increased by an integrating network at the output of the comparator so as to match the decrease in response of the drive unit.

The error due to the system response could be measured directly from the comparison (beat) of the fringe frequency with the reference frequency, using an oscilloscope or by counting the γ radiation at a velocity of 0.5Γ away from resonance as a function of the velocity correction signal. These random fluctuations never exceeded 10% of the reference frequency, which would correspond to a maximum error of $0.1 \times 1/4\lambda \cdot f$ or typically 2% of the line width of the standard in the worst case. Since the best frequency was random, this error could only increase the line width determination, and not the separation of the peaks. The systematic error as determined from the total fringe count with respect to the

reference frequency counts was found to be within the standard deviation of ± 5 in 10^5 fringes.

The cosine effect was minimized by using the proper aperture. For the measurements on the primary standards, a 0.25" diameter source and detector, separated by 2.0" were used, and the cosine effect correction was made for this geometry. The alignment of source and absorber gave negligible error.

In order to determine any long term stability effects on the standard, a series of spectra were taken with the high accuracy optical Mossbauer Spectrometer over a period of one year. No detectable changes in any of the parameters were observed. However, it is always considered advisable to store the crystal in a dark place away from any sources of extreme heat, cold or humidity.

C. Summary

A systematic study of the sources of random errors indicates that this error is represented entirely by the limitation in the total number of Mossbauer gamma rays detected. A lower random error can be obtained at the expense of increased measuring time. The limiting random error would be that caused by spectrometer drift. A similar study of systematic errors indicates that the accuracy is well within the limits imposed by the random error; consequently it can be said that if any systematic error exists it is less than 0.0002 cm/s for the quadrupole splitting.

5. THE USE OF THE STANDARD

Procedure for Measuring Chemical Shift and Reporting Differential Chemical Shift

The standard crystal can be used to calibrate the spectrometer before or after a measurement, or the standard spectrum and the spectrum to be calibrated can be accumulated simultaneously if a tandem spectrometer is available. Since the unknown is measured relative to the standard, the source parameters do not affect the determination of the differential chemical shift. For comparison, the various sources and their respective chemical shifts are shown in figure 1.

For detailed directions on the use of this standard, see the Certificate of Calibration on page 22.

6. SUMMARY

The characteristics of sodium nitroprusside fully meet the requirements for an acceptable Mossbauer standard. Its chemical stability, uniformity and doublet spectrum give the required accuracy needed for this spectroscopy. The results of this study are best summarized in the Certificate of Calibration which follows this page.

The use of this standard and the use of consistent reporting procedures of the spectrum parameters should provide stability to the growing field of Mossbauer spectroscopy. In addition, it should accelerate efforts to quantitatively understand the spectrum parameters by providing the theoretician with highly reliable data.

This Standard Reference Material can be purchased from

Office of Standard Reference Materials
National Bureau of Standards
Washington, D. C. 20234

Attention:
Standard Reference Materials Unit.

7. ACKNOWLEDGMENTS

The characteristics of sodium nitroprusside as a possible Mossbauer standard for chemical shift were first pointed out by G. K. Wertheim in a discussion with R. H. Herber, from the parameters published by Kerler and Neuwirth. During the Gordon Conference on Inorganic Chemistry in 1964, the need for a standard was discussed by Professors J. Danon, J. F. Duncan, V. I. Goldanskii, R. H. Herber, and N. N. Greenwood. Many of the specifications for a standard were pointed out by these persons and their assistance is deeply appreciated.

The initial single crystals were prepared by Dr. J. Torgesen and Mr. A. Horton; the x-ray analysis which led to the position of the 100 plane was conducted by E. Farabarough, all of the Inorganic Materials Division, NBS. The final crystals were prepared at the Isomet Corporation and the interest of Dr. I. W. Ruderman greatly facilitated the prompt delivery. The assistance of Mr. R. W. Shideler, (Analytical Chemistry Division) with the electronic instrumentation, Mr. J. M. Cameron of the Applied Mathematics Division, NBS with the mathematical statistics, Mr. E. Rhodes (Analytical Chemistry Division) with the computer programming, and Mrs. R. S. Maddock (Analytical Chemistry Division) with the preparation of the report is also gratefully acknowledged. The calculation by Mr. Paul Black (Analytical Chemistry Division) of the angular dependency of the electric quadrupole asymmetry is gratefully acknowledged.



Certificate of Calibration

Standard Reference Material 725

for

Mössbauer Differential Chemical Shift for Iron-57 Sodium Pentacyanonitrosylferrate(II) Dihydrate*

(Sodium Nitroprusside)

This Standard Reference Material was prepared from a single crystal of the compound sodium pentacyanonitrosylferrate(II) dihydrate, $\text{Na}[\text{Fe}(\text{CN})_5\text{NO}] \cdot 2\text{H}_2\text{O}$. The purity of this compound, also known as sodium nitroprusside, meets the specifications of the American Chemical Society for reagent-grade materials as verified by quantitative analysis of the main constituents, but should not be considered as entirely free from impurities such as heavy metals. It is in the form of a platelet of dimensions $1 \times 1 \times 0.0775 \pm 0.003^{**}$ cm that has been cut from a large single crystal. The 1×1 cm surface is parallel to the 100 crystal plane within ± 2 degrees of arc. The opposite 1×1 cm surfaces are parallel to within 0.001 cm with a surface finish of 20 microns. The natural iron concentration is 25.0 ± 1 mg/cm². The chemical shift of this Standard is compared to that of the National Bureau of Standards Primary Standard which has the value of zero cm/s differential chemical shift. This Standard has an average value for the chemical shift of 0.0000 ± 0.0002 cm/s at 25.0°C. This uncertainty is expressed as the standard deviation of a single determination derived from single measurements on 50 platelets. The National Bureau of Standards dual-spectra Mössbauer spectrometer [1,2] was used. The resonant spectra have considerable line-broadening due to the thickness of the absorber. The experimental line width (full width at half maximum) is 0.0305 ± 0.0004 cm/s. The line width corrected for thickness broadening is 0.0202 cm/s. The Mössbauer effect is 17 percent.

To allow the user to calibrate the velocity scale of a Mössbauer spectrometer, the electric quadrupole splitting of the Standard Reference Material was measured. The velocity scale of the dual-spectra comparison spectrometer was calibrated by measurement of the electric quadrupole splitting of the Primary Standards using an optical interferometric technique. The average value of the electric quadrupole splitting for this Standard is 0.1726 ± 0.0002 cm/s at 25.0°C where the uncertainty is expressed as the standard deviation of a single determination derived from single measurements on 10 platelets.

The details of the instrumentation and of preparation and measurement of the sodium nitroprusside crystals are given in NBS Miscellaneous Publication 260-13 entitled "Mössbauer Spectroscopy Standard for Chemical Shift of Iron Compounds."

The single crystal platelets of sodium nitroprusside were prepared by the Isomet Corporation of Palisades Park, New Jersey. The calibrations of the crystals were made within the National Bureau of Standards Institute for Materials Research, by J. J. Špijkerman, F. C. Ruegg, D. K. Snediker, and W. L. O'Neal of the Radiochemical Analysis Section, James R. DeVoe, Chief.

* This nomenclature is based upon the structure of this compound as determined by Mössbauer spectroscopy.

** Unless otherwise specified all uncertainties are standard deviation of a single determination.

REFERENCES:

- [1] Radiochemical Analysis: Activation Analysis, Instrumentation, Radiation Techniques, and Radioisotope Techniques, July 1963 to June 1964, James R. DeVoe, Editor, NBS Tech. Note 248, pp 25-37 (1964). Available from Superintendent of Documents, Government Printing Office, Washington, D.C. 20402, 50 cents a copy.
- [2] Radiochemical Analysis: Activation Analysis, Instrumentation, Radiation Techniques, and Radioisotope Techniques, July 1964 to June 1965, James R. DeVoe, Editor, NBS Tech. Note 276, pp 74-110 (1966). Available from Superintendent of Documents, Government Printing Office, Washington, D.C. 20402, \$1.00 a copy.

Directions for Use

The Standard Reference Material in the form of a single crystal platelet is sandwiched between two pieces of a 4 mil polyethylene film. Due to the advisability of keeping it free from moisture it is recommended that the platelet not be removed from this container. A suitable mounting consists of two concentric aluminum rings approximately 1.25 inches in diameter. The crystal, encased in the plastic envelope, is placed between the rings and the assembly is fastened together with small screws, thereby clamping the envelope firmly between the rings. Both rings have an inside diameter of 0.75 inch to expose the crystal and to prevent crushing of its edges. This was the procedure used in taking all of the data at NBS on this Standard Reference Material.

Place the Standard Reference Material as the absorber at 25.0° C in the Mössbauer spectrometer and take sufficient transmitted counts of the 14.4 kev gamma-ray from an iron-57 source to obtain counting statistics to the required degree of uncertainty. Determine the peak position of the electric quadrupole splitting. The use of digital computation techniques are recommended. Divide the distance between the peaks by two and assign this as the value for chemical shift indicated above. Replace the Standard crystal with the compound whose chemical shift is to be measured as the absorber in the spectrometer. Measure the peak position parameters as a difference between that of the unknown compound and the mid-point between the peaks of the Standard.

8. REFERENCES

- [1] Christ, B. W., Private Communication.
- [2] Schechter, H., Ron, M., Niedzwiedz, S., Herber, R. H., Nucl. Instr. Methods 44, 268 (1966).
- [3] Ford-Smith, M. H., The Chemistry of Complex Cyanides, Her Majesty's Stationery Office, London (1964) p. 18.
- [4] Sidgwick, N. V., Chemical Elements and Their Compounds, Oxford University Press, Oxford (1950).
- [5] Brauer, G., Handbuch der Preparativen Anorganischen Chemie, Enke Verlag Stuttgart (1954).
- [6] Mellor, D. P. and Craig, D. P., Proc. Roy. Soc., New South Wales 18, 25 (1944).
- [7] Reagent Chemicals, ACS Specifications, American Chemical Society, Washington, D. C. (1960) p. 476.
- [8] Ruderman, I. W., Isomet Corporation, Pallisades Park, New Jersey.
- [9] Playfair, C., Proc. Roy. Soc. (London) 74, 328 (1850).
- [10] Perret, A. and Gislou, A., Bull. Soc. Chim. 53, 283 (1933).
- [11] Sidgwick, op cit, p. 287.
- [12] Kazo, Noji., J. Pharm. Soc. Japan, 67, 6 (1947).
- [13] Handbook of Chemistry and Physics, 45th ed., Chemical Rubber Company, Cleveland, Ohio (1964).
- [14] Justin-Muellex, P., Bull. Soc. Chem. 55, 2, 1932 (1935); Overbeck, K., Pogg. Ann. 87, 110 (1935).
- [15] Taylor, J. K., Analysis and Purification Section, Analytical Chemistry Division, National Bureau of Standards, Private Communication.
- [16] Cooke, P. W., Nature 157, 518 (1946).
- [17] Manoharan, P. T. and Hamilton, W. C., Inorg. Chem. 2, 1043 (1963).
- [18] Mears, T., Private Communication.
- [19] Manoharan, P. T. and Gray, H. B., J. Am. Chem. Soc. 87, 3340 (1965).

- [20] Spijkerman, J. J., Ruegg, F. C., and May, L., "The Use of Mossbauer Spectroscopy in Iron Coordination Chemistry", Mossbauer Effect Methodology, 2, I. Gruverman, editor, Plenum Press, New York, 1966, p. 85.
- [21] Danon, J., "Mossbauer Effect and Chemical Bonding in Transition Metal Complexes", Technical Report Series No. 50, International Atomic Energy Agency, Vienna (1966) p. 89.
- [22] Goldanskii, V. I., Private Communication, Lecture "On the problem concerning the correlation of chemical shift and quadrupole interaction in NQR spectra for the electronic structure of iron atoms", International Atomic Energy Agency International Conference on Hyperfine Interactions, Wellington, New Zealand (October 1966).
- [23] Danon, J., J. Chem. Phys. 41, 3378 (1964).
- [24] Ruegg, F. C., Spijkerman, J. J., and Devoe, J. R., Rev. Sci. Inst. 36, 356 (1965).
- [25] DeVoe, J. R., ed., "Radiochemical Analysis: Activation Analysis, Instrumentation, Radiation Techniques, and Radioisotope Techniques", NBS Technical Note 404 (in press).
- [26] DeVoe, J. R., ed., "Radiochemical Analysis: Activation Analysis, Instrumentation, Radiation Techniques, and Radioisotope Techniques", NBS Technical Note 276 (Jan. 1966) p. 89.
- [27] DeVoe, J. R., Ibid., p. 101.
- [28] DeVoe, J. R., Ibid., p. 16.
- [29] DeVoe, J. R., Ibid., p. 84.
- [30] Fluck, E., Kerler, W., and Neuwirth, W., Ange. Chem. 2, 277 (1963).
- [31] Costa, N. L., Danon, J., and Xavier, R. M., J. Phys. Chem. Solids, 23, 1783 (1962).

- [32] Spijkerman, J. J., Ruegg, F. C., and DeVoe, J. R., "A Standard Reference Material for Mossbauer Spectroscopy of Iron and its Compounds", Technical Report Series No. 50, International Atomic Energy Agency, Vienna (1966), p. 254.
- [33] Margulies, S. and Ehrman, J. R., Nuclear Instr. Methods 12, 131 (1961).
- [34] Peshkin, M., Phys. Rev. 139, A717 (1965).
- [35] Kaufman, V., J. Opt. Soc. Am. 52, 866 (1962).
- [36] Blatt, J. M. and Weisskopf, V. F., Theoretical Nuclear Physics, John Wiley and Sons., Inc., New York (1952), p.37.
- [37] Goldanskii, V. I., Karyagin, S. V., Makarov, E. F. and Khrapov, V. V., Transactions of the Conference on the Mossbauer Effect (Dubna), Joint Institute of Nuclear Studies (1962).
- [38] Bearden, J. A., Private Communication.
- [39] Nuclear Data Sheets, Nuclear Data Group, Oak Ridge National Laboratory, Oak Ridge, Tennessee (1965).
- [40] Isaak, G. R. and Isaak, U., Phys. Letters 17, 51 (1965).
- [41] Locher, P. R. and Geschwind, S., Phys. Rev. 139, 722 (1965).
- [42] Hanna, S. S. and Preston, R. S., Phys. Rev. 139, 722 (1965).
- [43] Bearden, J.A., "X-Ray Wave Lengths", U. S. Atomic Energy Commission Report NYO-10586 (1964).
- [44] Compton, A. H. and Allison, S. K., X-Rays in Theory and Experiment, D. Van Nostrand Co., Inc., Princeton, N. J. (1935).
- [45] Heinrich, K. F. J., "An Outline for Cooperative Action on the Determination of X-Ray Mass Attenuation Coefficients in the Wavelength Range from 0.5 to 100 Å (25 to 0.12 KeV)", NBS Technical Note 284 (Feb. 1966).

APPENDIX A

COMPUTER CURVE FITTING FOR MOSSBAUER SPECTRA

The mathematical analysis described below resolves a series of Mossbauer peaks superimposed on a baseline parabola. Lorentzian functions are used for the Mossbauer absorption profile, and since the equations involved in finding the best fit are non-linear, a solution cannot be obtained. However, by making several approximations and substitutions, linear equations result which can be solved for approximate results. The nature of these approximations requires initial estimates of peak position and half width (half width at half maximum) to be made manually. Once the equations are solved, results of the first solution can be used as new input estimates, and the solution procedure repeated. By iterating in this fashion, a solution is obtained.

The basic form of a curve consisting of n Lorentzians and a parabola is

$$Y = \left[\sum_{i=1}^n \frac{A_i}{1 + \left(\frac{x - p_i}{B_i} \right)^2} \right] + \left[E + Fx + Gx^2 \right] \quad (1)$$

where the first bracketed term is the sum of the n Lorentzians and the second term the equation for the parabola. Here A_i , p_i , and B_i are the amplitude, position, and half width of the i th (Lorentzian), and E , F and G have their usual meaning*. These $3n+3$ parameters are the unknowns to be solved for by the program. Since a successive-approximation method is used, input to the computer must include a convergence criterion, specifying the lower limit parameter corrections desired in the solution, and

* This method is used in a series of computer programs called PARLORS written in FORTRAN 4.1 for the CDC 3600 [25].

a maximum number of iterations (e.g. a limit on the number of times the program will iterate in the event of diverging solutions) as well as the required estimates.

Once a suitable number of iterations is obtained the program prepares:

- 1) a subtract matrix, containing distance between any two peaks above the diagonal, peak position along diagonal and the centroid of any two peaks below the diagonal;
- 2) an area fraction matrix, containing the ratio of the area under two peaks off the diagonal, and the fraction of the area under one peak to the total area on the diagonal;
- 3) an error analysis; and
- 4) several types of plots.

METHOD OF SOLUTION

To find the best least square fit to a set of data (x_j , y_j) the quantity

$$S = \sum_{j=1}^k [y_j(\text{obs}) - y_j(\text{theor})]^2 \quad (2)$$

must be minimized. (For most sets of data, k is equal to 200 channels.) From (1) the expression for $y_j(\text{theor})$ is substituted:

$$S = \sum_{j=1}^k \left\{ y_j(\text{obs}) - \left[\sum_{i=1}^n \frac{A_i}{1 + \left(\frac{x_j - p_i}{B_i} \right)^2} + E + Fx_j + Gx_j^2 \right] \right\}^2 \quad (3)$$

To linearize the equation the following definitions are made:

$$h_1 = \left(\frac{1}{B_1} \right)^2 \quad (4)$$

$$h_1 = H_1 + \delta_1 \quad \text{where} \quad \delta_1 \ll H_1 \quad (5)$$

$$p_1 = P_1 + \gamma_1 \text{ where } \gamma_1 \ll P_1 \quad (6)$$

where H_1 and P_1 are the estimated values of h_1 and P_1 , the peak height and position with error δ_1 and γ_1 , respectively. Using (4)

$$\frac{A_1}{1 + \left(\frac{x_j - p_1}{B_1}\right)^2} = \frac{A_1}{1 + h_1 (x_j - p_1)^2} \quad (7)$$

to linearize the equations, (5) and (6) are substituted into (7). The result is expanded by the binomial theorem, and all higher terms (non linear) of δ_1 , γ_1 are neglected.

$$\begin{aligned} \frac{A_1}{1 + h_1 (x_j - p_1)^2} &= \frac{A_1}{1 + H_1 (x_j - P_1)^2 + \delta_1 (x_j - P_1)^2 - 2H_1 \gamma_1 (x_j - P_1)} \\ &= \frac{A_1}{1 + H_1 (x_j - P_1)^2 \left[1 + \frac{\delta_1 (x_j - P_1)^2 - 2H_1 \gamma_1 (x_j - P_1)}{1 + H_1 (x_j - P_1)^2} \right]} \end{aligned} \quad (8)$$

Let $Q_{1j} = 1 + H_1 (x_j - P_1)^2$, then the right side of equation (8)

$$\text{becomes } \frac{A_1}{Q_{1j}} + \frac{2A_1 H_1 (x_j - P_1) \gamma_1}{Q_{1j}^2} - \frac{A_1 (x_j - P_1)^2 \delta_1}{Q_{1j}^2}$$

Substituting (8) into (3)

$$\begin{aligned} S &= \sum_{j=1}^k \left\{ y_j - \left[\sum_{i=1}^n \frac{A_i}{Q_{ij}} + \frac{2A_1 H_1 (x_j - P_1) \gamma_1}{Q_{ij}^2} - \frac{A_1 (x_j - P_1)^2 \delta_1}{Q_{ij}^2} \right] \right. \\ &\quad \left. + F_{xj} + G_{xj} \right\}^2 \end{aligned} \quad (9)$$

Letting $C_i = 2A_i H_i \gamma_i$ and $D_i = A_i \delta_i$

$$S = \sum_{j=1}^k \left\{ y_j - \left[\sum_{i=1}^n \frac{A_i}{Q_{ij}} + \frac{C_i (x_j - P_i)}{Q_{ij}^2} + \frac{D_i (x_j - P_i)^2}{Q_{ij}^2} + \dots + E + Fx_j + Gx_j^2 \right] \right\}^2 \quad (10)$$

The unknowns are now A_i, C_i, D_i , for $i = 1, 2, \dots, n$ and E, F, G used in the minimization of S results in a set of $3n+3$ simultaneous linear equations, which are the usual normal equations of least squares. The following manipulations simplify setting up these equations, and in fact follow the method used in the computer program:

Let y' be the row vector (prime denotes transpose)

$$y' = (y_1 \ y_2 \ \dots \ y_k) \quad (11)$$

denoting the k observations and let Z' be a row vector

$$Z = (A_1, C_1, D_1, A_2, C_2, \dots, A_n, C_n, D_n, E, F, G) \quad (12)$$

denoting the $3n+3$ unknowns and let

$$T = \begin{bmatrix} \frac{1}{Q_{11}}, \frac{x_1 - P_1}{Q_{11}^2}, \frac{(x_1 - P_1)^2}{Q_{11}^2}, \frac{1}{Q_{12}}, \frac{x_1 - P_2}{Q_{12}^2}, \frac{(x_1 - P_2)^2}{Q_{12}^2} \dots 1, x_1, x_1^2 \\ \frac{1}{Q_{21}}, \frac{x_2 - P_1}{Q_{21}^2}, \frac{(x_2 - P_1)^2}{Q_{21}^2}, \frac{1}{Q_{12}}, \frac{x_2 - P_2}{Q_{22}^2}, \frac{(x_2 - P_2)^2}{Q_{22}^2} \dots 1, x_2, x_2^2 \\ \vdots \\ \frac{1}{Q_{k1}}, \frac{x_k - P_1}{Q_{k1}^2}, \frac{(x_k - P_1)^2}{Q_{k1}^2}, \frac{1}{Q_{k2}}, \frac{x_k - P_2}{Q_{k2}^2}, \frac{(x_k - P_2)^2}{Q_{k2}^2} \dots 1, x_k, x_k^2 \end{bmatrix} \quad (13)$$

So that the normal equations become

$$T' T Z = T' y \quad (14)$$

The matrix equation (14) is then solved for the values of Z. Then

$$\begin{aligned}
 A_1 &= Z_{3i-2} \\
 \gamma_1 &= \frac{Z_{3i-1}}{2H_1 Z_{3i-2}} \\
 \delta_1 &= \frac{Z_{3i}}{A_1} = \frac{Z_{3i}}{Z_{3i-2}}
 \end{aligned}
 \tag{15}$$

$$E = Z_{3n+1} \quad F = Z_{3n+2} \quad G = Z_{3n+3}$$

From these corrections, γ_1 and δ_1 , a better estimate of P_1 and h_1 (and thus B_1) are obtained. (Note that because of the approximations made the solutions are not exact). If more accuracy is desired, reiterate by replacing the old estimates with the corrected estimates and repeat the whole procedure.

ERROR ANALYSIS

Once the value of each unknown has been obtained, the theoretical value of the data points ($y_{j\text{-theor}}$) can be calculated. The mean square residual,

$$s^2 = \left[\sum_{j+1}^k \left(y_{j\text{-obs}} - y_{j\text{-theor}} \right)^2 \right] / (k-3n-3) \tag{16}$$

describes the precision of fit. (k is the number of data points; and $3n+3$ the number of parameters solved for.) The variance-covariance matrix for Z is then

$$\text{Var}(Z) = (T'T)^{-1} \sigma^2 \tag{17}$$

The variances of A_1 , E, F, and G are given by the diagonal terms of (17) and the covariance of Z_1 and Z_j by the i, j terms.

Using propagation of error formulae and (15)

$$\text{Var}(\delta_1) = (\delta_1)^2 \left[\frac{\text{Var}(D_1)}{D_1^2} + \frac{\text{Var}(A_1)}{A_1^2} - \frac{2\text{Cov}(A_1, D_1)}{A_1 D_1} \right] \quad (18)$$

Then the approximation $\text{Var}(h_1) = (\delta_1)$ is made and since from $B_1 = 1/h_1$,

$$\text{Var}(B_1) = \left[\frac{\partial B_1}{\partial h_1} \right]^2 \text{Var}(h_1) = \frac{\text{Var}(\delta_1)}{4h_1^3} \quad (19)$$

Since $\gamma_1 = C_1/2A_1H_1$, $\text{Var}(\gamma_1)$ depends on $\text{Var}(H_1)$. Because $h_1 = H_1$, the equation

$$\gamma_1 = \frac{C_1}{2A_1h_1} = \frac{C_1}{2A_1H_1 - 2D_1} \quad (20)$$

is used in the error analysis to take account of the error in half width.

Because A_1 , C_1 , and D_1 are determined from the same data they will involve the same random errors and hence be correlated. This correlation is expressed by the terms of the variance-covariance matrix as follows:

$$M = \begin{bmatrix} \text{Var}(A_1) & \text{Cov}(A_1C_1) & \text{Cov}(A_1D_1) \\ \text{Cov}(A_1C_1) & \text{Var}(C_1) & \text{Cov}(C_1D_1) \\ \text{Cov}(A_1D_1) & \text{Cov}(C_1D_1) & \text{Var}(D_1) \end{bmatrix} \quad (21)$$

The variances and covariances of

$$C_1 = [0 \quad 1 \quad 0] \begin{bmatrix} A_1 \\ C_1 \\ D_1 \end{bmatrix} \quad (22)$$

and

$$2A_1H_1 - 2D_1 = \begin{bmatrix} 2H_1 & 0 & -2 \end{bmatrix} \begin{bmatrix} A_1 \\ C_1 \\ D_1 \end{bmatrix} \quad (23)$$

are given by

$$\begin{bmatrix} 0 & 1 & 0 \\ 2H_1 & 0 & -2 \end{bmatrix} M \begin{bmatrix} 0 & 2H_1 \\ 1 & 0 \\ 0 & -2 \end{bmatrix} = \quad (24)$$

$$\left[\begin{array}{c} \text{Var}(C_1) \left[2H_1 \text{Cov}(A_1, C_1) - 2\text{Cov}(C_1, D_1) \right] \\ \left[2H_1 \text{Cov}(A_1, C_1) - 2\text{Cov}(C_1, D_1) \right] \left[4H_1^2 \text{Var}(A_1) - 8H_1 \text{Cov}(A_1, D_1) + 4\text{Var}(D_1) \right] \end{array} \right]$$

Substituting the appropriate matrix elements into equation (18) gives

$$\text{Var}(\gamma_1) = (\gamma_1)^2 \left[\frac{\text{Var}(C_1)}{C_1^2} + \frac{H_1^2 \text{Var}(A_1) - 2H_1 \text{Cov}(A_1, D_1) + \text{Var}(D_1)}{(A_1 H_1 - D_1)^2} - \frac{2[H_1 \text{Cov}(A_1, C_1) - \text{Cov}(D_1, C_1)]}{C_1 [A_1 H_1 - D_1]} \right] \quad (25)$$

Finally the approximation $\text{Var}(P_1) = \text{Var}(\gamma_1)$ is made. By the above formulas the values and variances of all the parameters in (1) can be determined.

APPENDIX B

ANGULAR DISTRIBUTION OF RADIATION IN THE
MOSSBAUER EFFECT

We consider the particular case of the Mossbauer transitions in Fe-57. These transitions occur between the ground state of spin-1/2 and the first excited state (14.4 kev) of spin-3/2.

The spin-3/2 state possesses 4 magnetic substates ($\pm 3/2$, $\pm 1/2$) so that there are 6 possible Mossbauer transitions:

$3/2 \rightarrow 1/2$	$\Delta m = -1$	$9/4(1+\cos^2\theta)$
$-3/2 \rightarrow -1/2$	$= +1$	
$1/2 \rightarrow 1/2$	$= 0$	$3 \sin^2\theta$
$-1/2 \rightarrow -1/2$	$= 0$	
$-1/2 \rightarrow 1/2$	$= +1$	$3/4(1+\cos^2\theta)$
$1/2 \rightarrow -1/2$	$= -1$	

Here Δm represents the z-component of angular momentum which is carried off by the photon, or gamma ray, in the transition.

The angular distribution of radiation is derived with the aid of the theory of multiple fields. In this particular example we are concerned with transitions which involve magnetic dipole radiation. The angular distribution is given by the equation [36]

$$\begin{aligned}
 Z_{\ell m}(\theta, \phi) &= \vec{X}_{\ell m}^* \cdot \vec{X}_{\ell m} \\
 &= 1/2 \left[1 - \frac{m(m+1)}{\ell(\ell+1)} \right] \left| Y_{\ell, m+1} \right|^{2+1/2} \left[1 - \frac{m(m-1)}{\ell(\ell+1)} \right] \\
 &\quad \left| Y_{\ell, m-1} \right|^2 + \frac{m^2}{\ell(\ell+1)} \left| Y_{\ell, m} \right|^2
 \end{aligned}$$

In this equation θ is the angle between the gamma ray and the quantization axis, and ϕ is the azimuthal angle about this axis; l is the multipole of the radiation and m is the z-component of angular momentum of this radiation; the $Y_{lm}(\theta, \phi)$ called the vector spherical harmonics and are related to the spherical harmonics by the relation

$$\vec{X}_{Lm}(\theta, \phi) = \vec{L} Y_{Lm}(\theta, \phi) \quad \vec{L} = i\hbar \vec{r} \times \vec{\nabla}$$

where L is the quantum mechanical angular momentum operator. The physical significance of the vector spherical harmonic $X_{lm}(\theta, \phi)$ is that it completely determines the angular dependence of the electric and magnetic multipole fields.

The relative transition probabilities of the various transitions are determined by the Clebsch-Gordon coefficients (also called vector addition coefficients, Wigner coefficients, or C-coefficients). The probability that a transition will occur is given by $C_{\ell\ell', m, m'}^2(JM; m, m')$ (notation of Blatt-Weisskopf [36]). In this notation ℓ is the spin of the photon ($=1$) and ℓ' is the spin of the ground state; J, M are the spin and z component of spin for the excited state; m is the z-component of angular momentum carried off by the photon in the transition and m' is the z-component of spin for the ground state. Clearly, $M = m + m'$ (conservation of z-component of spin). The transitions and their relative probabilities in the cases when the degeneracy of the magnetic substates is resolved and unresolved are indicated below:

<u>Transition</u>	<u>Relative Probability</u>
$1/2 \rightarrow 3/2, \quad \Delta m = +1,$	3
$-1/2 \rightarrow 1/2, \quad \Delta m = +1,$	1
$1/2 \rightarrow 1/2, \quad \Delta m = 0,$	2
$-1/2 \rightarrow -1/2, \quad \Delta m = 0,$	2
$1/2 \rightarrow -1/2, \quad \Delta m = -1,$	1
$-1/2 \rightarrow -3/2, \quad \Delta m = -1,$	<u>3</u>

<u>Transition</u>	<u>Relative Probability</u>
$\pm 3/2 \rightleftharpoons \pm 1/2$	1
$\pm 1/2 \rightleftharpoons \pm 1/2$	1

In the case when the degeneracy is unresolved, the angular distribution of radiation and the relative transition probabilities are given by:

$\pm 3/2 \rightleftharpoons \pm 1/2$	$3/2(1+\cos^2\theta)$	1
$\pm 1/2 \rightleftharpoons \pm 1/2$	$1+3/2 \sin^2\theta$	1

Now in the case of single crystals the absorption spectrum will possess a pronounced asymmetry. This is due to the fact that the distribution of radiation is affected by the crystal structure in a complicated way (Goldanskii-Karyagin Effect [37], which varies for different crystals. In this case the distributions given above must be multiplied by the so-called Lamb-Mossbauer or Debye-Waller factor $f(\theta)$ which depends on the angle θ as well as on the temperature and the energy of transition. It is clear that the factor $f(\theta)$ acts as a kind of distribution function which selects only the Mossbauer transitions, i.e., only recoil-free transitions.

From figure 6, the electric field gradient vector is at an angle of 54° with the 100 crystal plane. The $\pm 3/2$ state is of higher energy than the $\pm 1/2$ state and the electric field gradient is positive. For the 001 and 010 planes, the intensity ratio is 1.55 and 0.65, respectively. The calculated values of figure 6 differ from the experimentally observed values of 1.35 and 0.74, indicating the possibility of a Goldanskii-Karyagin Effect.

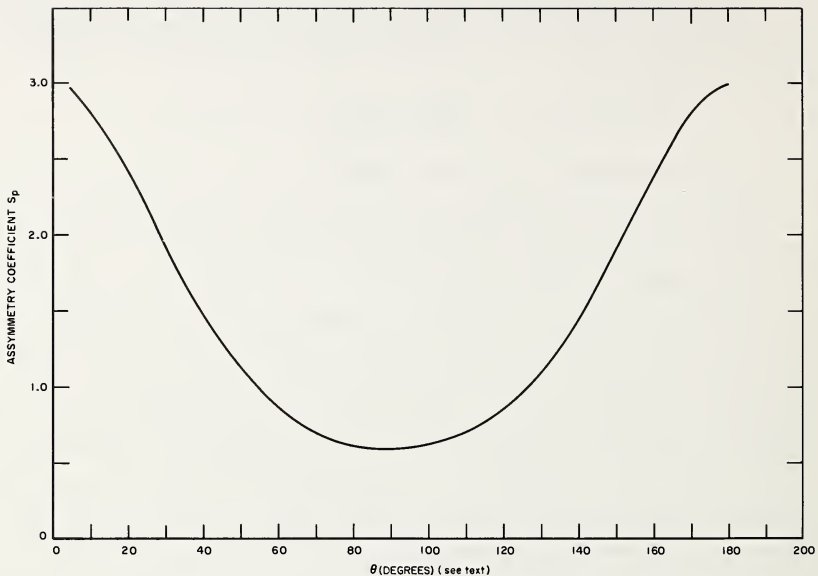

Figure 6. Peak intensity asymmetry for the ${}^{\pm}3/2 \rightarrow {}^{\pm}1/2$ doublet in iron compounds as a function of the angle between the electric field gradient and the incident radiation.

APPENDIX C

FORMAT FOR PRESENTATION OF EXPERIMENTAL MOSSBAUER
SPECTRA AND PARAMETERS

Typical of every new spectroscopic discipline, there has been a variety of presentations of spectra using different nomenclature and units for the spectrum parameters. For purposes of encouraging spectroscopists to report their data in a uniform manner a suggested format and nomenclature are described below. It is hoped that these reporting procedures will serve as a basis for those accepted by pertinent governing bodies such as the International Union of Pure and Applied Chemistry.

Nomenclature for the pertinent Mossbauer parameters are presented in Table 1. Certain explanations are necessary. The electric quadrupole splitting can best be represented by subscripting the magnetic quantum numbers of the transitions. Since the separation between two peaks must be represented as the difference between two sets of transition energies, the value of ΔE_Q must be followed by a subscripted matrix indicating the two transitions. The magnetic quantum numbers in the excited and ground state of transition 1, $(m_1^!, m_1)$ and that of transition 2, $(m_2^!, m_2)$ uniquely define ΔE_Q .

The line width Γ obtained experimentally is to be contrasted with Γ_0 the theoretical line width. Corrections for thickness of the absorber [33] for the cosine effect [27] and other effects including instrument broadening may be applied to Γ in order to approach Γ_0 .

Reporting the magnitude of the effect requires great care if laboratory independency on measurement is to be retained. The expression given requires that $h(\nu)$ be corrected to the peak height that a Lorentzian function would have if the peak were of theoretical width (Γ_0). This eliminates many of the

Table 1 – Nomenclature for Experimental Mossbauer Spectrum Parameters.

Name	Symbol	Units	Definition
Differential Chemical Shift	δ_0	cm/s	Displacement of the center of a singlet or a multiplet, from the center of the doublet of the standard reference material.
Quadrupole Splitting	$\Delta E_Q \begin{pmatrix} m'_1, m_1 \\ m'_2, m_2 \end{pmatrix}$	cm/s	The separation of two peaks resulting from two transitions (1 and 2) from the excited (prime) to the ground state that results from electric quadrupole interaction with an electric field gradient, where m represents the magnetic quantum number resulting from this interaction.
Temperature Coefficient of the differential chemical shift	δ_T	cm/s/°K	The variation in δ_0 with temperature in degrees Kelvin. The temperature range should be specified.
Temperature coefficient of the quadrupole splitting	Q_T	cm/s/°K	The variation of ΔE_Q with temperature in degrees Kelvin. The temperature range should be specified.
Line width	Γ	cm/s	The full width at half maximum of the Mossbauer peak.
Magnitude of the Effect	ϵ	percent	$= \frac{[h(\infty) - h(v)]}{h(\infty) - B} \times 100$ <p>where $h(\infty)$ = height of resonance base line $h(v)$ = height of peak at absorption maximum B = background</p> <p>$h(v)$ is to be normalized to peak height corresponding to theoretical line width.</p>
Asymmetry Coefficient	S_p		The ratio of the more positive velocity peak height to the more negative velocity peak height of a doublet. For normalization see $h(v)$ above.
	S_a		The ratio of the more positive velocity absorption area to the more negative velocity absorption area.

problems of peak area and base line estimation. It is necessary to evaluate the background which results from such non-resonant radiation as Compton scatter, x-ray fluorescence, etc. Such backgrounds are certain to be different for different spectrometer source-detector configurations. The type of sample matrix will also alter this background correction. It is to be understood that the emphasis is on direct experimental parameters. It is possible to relate ϵ to the Debye-Waller factor for the absorber if such a factor is also known for the source.

The same normalization of h as for $h(\nu)$ described above is required for determining S_p . The asymmetry coefficient which measures areas (S_a) can best be obtained by evaluating the function parameters of the Lorentzian using a least squares fit to the experimental data. The area of the peak can then be obtained by evaluating the function.

An example of a spectrum reporting format is shown on pages 40 through 42. The first page contains all the necessary chemical data such as purity. References on synthesis, structure, and other work on the spectroscopy of the compound are given. On the second page is the spectrum showing a best least squares fit of Lorentzian functions to the experimental data points. A parabolic baseline may have to be subtracted as well. For transmission spectra the peak should be pointing downward. On the third page are the calculated parameters and their random error reported as a standard deviation of a single determination. All of the unprocessed data in the spectrum is given on this page.

SODIUM NITROPRUSSIDE
DISODIUM PENTACYANONITROSYL FERRATE DIHYDRATE

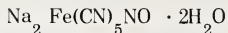

SINGLE CRYSTAL

Supplier – Isomet Corporation

Muir Index No.	Reference	Temperature	δ cm/s	ΔE_Q cm/s
62C03	N. L. Costa, J. Danon and R. M. Xavier, J. Phys. Chem. Solids <u>23</u> , 1783 (1962)	Room	-0.012 ± 0.005	0.185 ± 0.005
62E01	L. M. Epstein, J. Chem. Phys. <u>36</u> , 2731 (1962)	Room	-0.0165 ± 0.001	0.176 ± 0.001
62K01	W. Kerler and W. Neuwirth, Z. Physik. <u>167</u> , 176 (1962)	Room	-0.0176 ± 0.0008	0.1700 ± 0.0012
		-107°C	-0.0567 ± 0.0003	0.1725 ± 0.0006
		-25°C	-0.0592 ± 0.0003	0.1715 ± 0.0006
		25°C	-0.0607 ± 0.0003	0.1712 ± 0.0006
		(9.1 mg/cm ²) 60°C	-0.0616 ± 0.0003	0.1712 ± 0.0006
		(9.1 mg/cm ²) 25°C	-0.0608 ± 0.004	0.1723 ± 0.0008
62K02	W. Kerler, Z. Physik. <u>167</u> , 194 (1962)	25°C	-0.06064 ± 0.00007	0.1713 ± 0.0004
		J. Danon, J. Chem. Phys. <u>41</u> , 3378 (1964)		
		P. T. Manoharan and H. B. Gray, J. Am. Chem. Soc., <u>87</u> , 3340 (1965)		
		F. A. Cotton, R. R. Manochamp, R. J. M. Henry, R. C. Young, J. Inorg. Nucl. Chem. <u>10</u> , 28 (1959)		

Allow _____ picas
Margin to trim

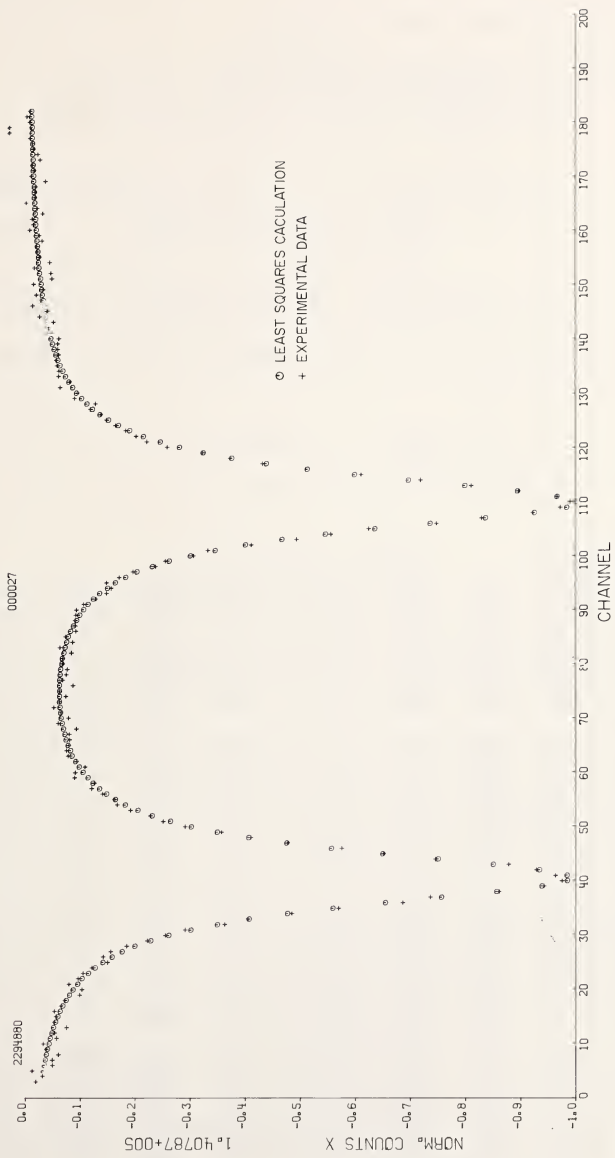

% Absorption (γ radiation) – 85%

Thickness 25.0 ± 1 mg/cm² single crystal (100 plane)

Peak	δ_o (cm/s)	ΔE_Q (cm/s)	Γ (cm/s)
1	0.0000 ± 0.0001	0.1726 ± 0.0001	0.0304 ± 0.0002
2			0.0308 ± 0.0002

Peak	Area (counts)	Height (counts)	Base line (counts)
1	(2.687 ± 0.04) $\times 10^6$	(1.3833 ± 0.007) $\times 10^5$	(2.19456 ± 0.005) $\times 10^6$
2	(2.768 ± 0.04) $\times 10^6$	(1.3984 ± 0.007) $\times 10^5$	

Unprocessed data:

000000	185997	190807	189132	191878	186642	186686	185191	188343	189113
185753	186400	183291	186389	185975	186520	184786	183915	180072	179562
182995	180623	179407	177123	173075	174157	172302	168264	162990	158375
153363	143202	137297	126193	114312	097781	090890	073297	061825	057296
058878	063861	070921	089636	102944	113602	127503	136850	144325	153755
159287	162577	167681	171116	171750	174878	177749	177059	182134	181894
179461	181638	183761	184177	183643	183461	183595	181701	186389	183730
185731	187497	186049	184358	186144	182573	185224	184291	184080	185317
185205	182964	186028	182666	184621	181908	182042	182061	181927	181661
179842	176659	173915	172750	173972	170675	167063	161391	158778	151596
148028	136861	125277	116570	106843	089450	077905	064804	057807	055160
058619	068371	080458	093502	108667	122823	133804	142083	149065	158080
163265	165875	168543	171242	173599	175033	177722	176354	181707	181117
185265	182719	185656	185603	186113	186194	185562	185783	185786	185549
187370	188074	186808	190216	188192	192002	189848	190959	189255	191692
186963	187241	191423	187365	190103	190544	190650	189289	189857	192230
191437	191669	188937	190265	193064	190705	190663	190524	187944	191607
190787	191118	189108	189663	190713	191060	191569	193100	193253	191511
192120	191219	114977	100000	000000	000000	000000	000000	000000	000000
000000	000000	000000	000000	000000	000000	000000	000000	000000	000000

APPENDIX D

PHYSICAL CONSTANTS AND CONVERSION FACTORS FOR IRON-57 MOSSBAUER SPECTROSCOPY

Nuclear Parameters

Excited State of ^{57}Fe

Energy, $E_0 = 14.37 \text{ KeV}, 0.864 \text{ \AA}$ [38]

Half life, $T_{1/2} = 9.8 \times 10^{-8} \text{ s}$ [39]

Internal conversion coefficient, $\alpha = 9.2 \pm 0.5$ [40,41]

Spin, $I = 3/2^-$ [41]

Magnetic moment, $\mu_e = -0.0154 \text{ nm}$ [39]

Quadrupole moment, $Q_e = +0.285 \times 10^{-24} \text{ cm}^2$ [39]

Ground State of ^{57}Fe

Spin, $I = 1/2^-$ [39]

Magnetic moment, $\mu_g = +0.09024 \pm 0.00007 \text{ nm}$ [41]

Mossbauer Parameters

Cross section, $\sigma_m = 1.91 \pm 0.014 \times 10^{-18} \text{ cm}^2$ [42]

Natural line width, $\Gamma_0 = 4.655 \times 10^{-9} \text{ eV}$ [39]

$= 0.009699 \text{ cm/s}$

$= 7.457 \times 10^{-21} \text{ ergs.}$

$= 1.126 \times 10^6 \text{ hertz}$

$= 1.781 \times 10^{-31} \text{ kcal}$

$= 3.755 \times 10^{-6} \text{ cm}^{-1}$

Iron Atomic Parameters

Ground state configuration: $4s^1 3d^7$

X-ray lines: $K_{\alpha} = 6.4 \text{ keV}, 1.936 \text{ \AA} [43]$

$K_{\beta} = 7.06 \text{ keV}, 1.75 \text{ \AA} [43]$

Mass adsorption coefficient, $-\mu/\rho (14.4\text{keV}) =$
 $63.5 \text{ cm}^2/\text{g} [13,45]$

X-ray scattering cross section, $\alpha_x(\text{Fe}, 14.4\text{keV}) =$
 $4 \times 10^{-24} \text{ cm}^2/\text{atom} [44]$

Mossbauer Iron-57 Standard Reference Material Parameters

Quadrupole splitting, $\Delta E_Q = 8.284 \pm 0.0095 \times 10^{-8} \text{ eV}$
 $= 0.1726 \pm 0.0002 \text{ cm/s}$
 $= 8.284 \pm 0.015 \times 10^{-20} \text{ ergs.}$
 $= 2.003 \pm 0.023 \times 10^7 \text{ hertz}$
 $= 1.979 \pm 0.036 \times 10^{-30} \text{ kcal}$
 $= 6.682 \pm 0.077 \times 10^{-4} \text{ cm}^{-1}$

Percent effect, $\epsilon = 17\%$

Temperature dependence of the quadrupole splitting,
 $(Q_T) = 10^{-5} \text{ cm, s}^{-1}, \text{ } ^{\circ} \text{K}^{-1} [30]$

Temperature dependence of the chemical shift, $\delta_T =$
 $3 \times 10^{-5} \text{ cm, s}^{-1}, \text{ } ^{\circ} \text{K}^{-1} [30]$

Gamma attenuation = 85%

For ^{57}Fe only:

$1 \text{ cm/s} = 4.798 \times 10^{-7} \text{ eV}$
 $= 6.242 \times 10^{11} \text{ erg}$
 $= 4.136 \times 10^{-15} \text{ hertz}$
 $= 2.613 \times 10^{22} \text{ kcal}$
 $= 1.240 \times 10^{-4} \text{ cm}^{-1}$

APPENDIX E

ATTENUATION AND LINE BROADENING FOR ^{57}Fe ABSORBERS

The required thickness of the standard reference absorber, and for all Mossbauer absorbers, is determined by the gamma-ray attenuation and the line broadening which limits the resolution.

The attenuation of the 14.4 keV radiation can be calculated from the mass absorption coefficient, μ_m , and the absorber area density, t_p (g/cm^2), using the equation:

$$I = I_0 e^{-\mu_m t_p}$$

while for compounds:

$$\mu_m t_p = \sum_i \mu_{m_i} t_{p_i}$$

The subscript referring to the elements forming the compound.

The mass absorption coefficients, μ_m , for 14.4 keV radiation plotted as a function of element [13] are shown in Figure 7.

The line broadening can be calculated by the method of Margulies and Ehrman [33] for the correction of Mossbauer line width for source and absorber thickness, the result of which is shown in Figure 7. The width can be found from the effective absorber thickness $T_a = f'_a t_p$, obtained from the Debye-Waller factor, f'_a , of the absorber, and the absorber thickness in g/cm^2 of natural abundance iron. Figure 8 is a plot of the broadening of the transmitted line for a source having a uniform distribution of cobalt-57 atoms on a non-ferrous matrix. The emission and absorption spectra are assumed to be Lorentzian. It is to be understood that this graph is to be used as a guide. If highly reproducible results are desired, mathematical computation should be used.

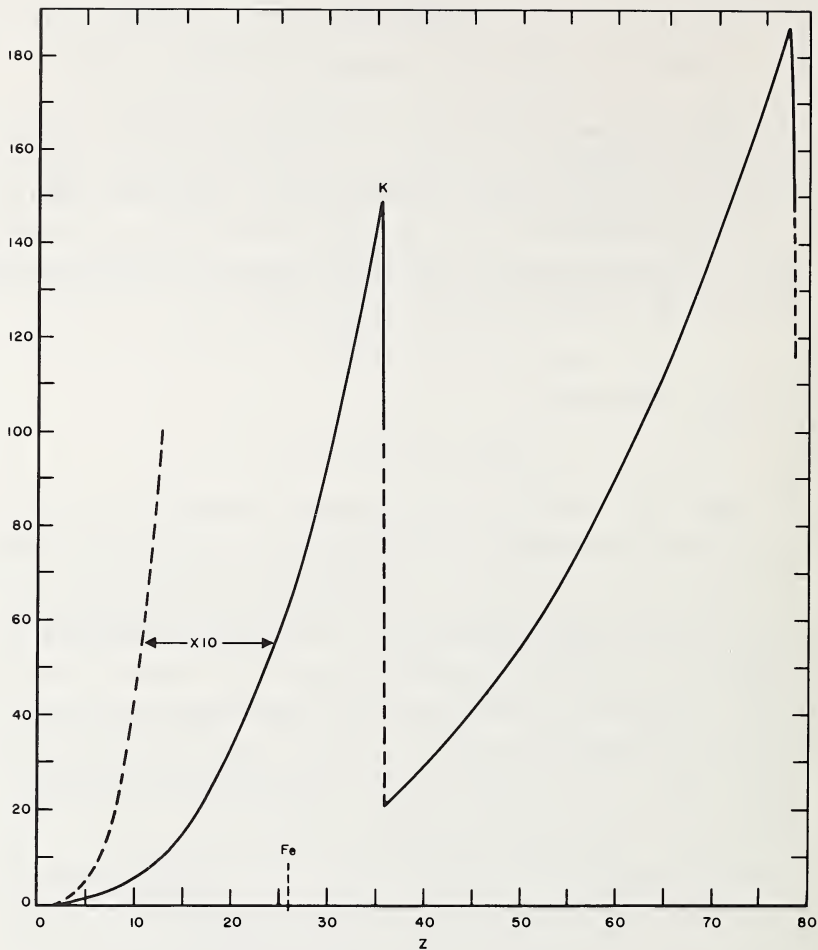

Figure 7. Attenuation coefficients for 14.4 keV gamma radiation as a function of element.

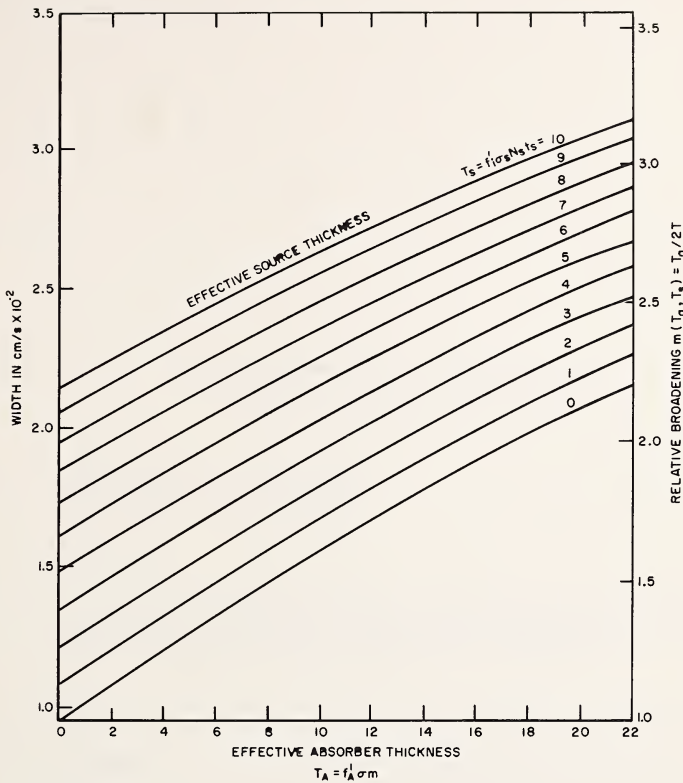

Figure 8. Plot of effective source thickness. Adapted from Margulies and Ehrman [33].

- f_i^i = recoilless fraction of source or absorber
 where subscript i=a, i=s represents
 absorber and source respectively.
 t_p = thickness of absorber in mg/cm^2 .
 s = Mossbauer cross section of ^{57}Fe cm^2/atom .
 N_s = number of ^{57}Fe atoms in the source per cm^3 .
 t_s = thickness of source in cm.
 a = experimental full width at half maximum.
 T_a = effective absorber thickness (mg/cm^2).
 T_s = source thickness.

Announcement of New Publications on
Standard Reference Materials

Superintendent of Documents
Government Printing Office
Washington, D. C. 20402

Dear Sir:

Please add my name to the announcement list of new publications to be issued in the series: NBS Miscellaneous Publication 260 - Standard Reference Materials.

Name _____

Company _____

Address _____

City _____ State _____ Zip Code _____

(Notification key N-330)

(cut here)



U.S. DEPARTMENT OF COMMERCE
WASHINGTON, D.C. 20230

POSTAGE AND FEES PAID
U.S. DEPARTMENT OF COMMERCE

OFFICIAL BUSINESS
