

## TABLE OF CONTENTS – REFERENCE MATERIALS

Redelegation of .ID.....	p. 2-11
Redelegation of .EE.....	p. 12-18
Delegation of .MOH.....	p. 19-25
Appointment of Ben Butler to SSAC.....	p. 26-30
Confidential Employment Matter .....	p. 31-38
AROS Contract Agreement Approval.....	p. 39-44
Update to the IDN ccTLD Fast Track Implementation.....	p. 45-116
Approval of 2013 RAA.....	p. 117-312

**2013-06-27-01b-Reference Materials-Annex A-Checklist-  
Redelegation of .ID domain.docx**

Sensitive Delegation Information

Sensitive Delegation Information

**SIGNATURE BLOCK**

Submitted by: Kim Davies  
Position: IANA Function Liaison for Root Zone Management  
Date Noted: 24 May 2013  
Email: kim.davies@icann.org

**2013-06-27-01b-Reference Materials-Annex B-  
Redelegation of .ID domain.pdf**

Sensitive Delegation Information

Sensitive Delegation Information



Sensitive Delegation Information

Sensitive Delegation Information

Sensitive Delegation Information

# **2013-06-27-01c-Reference Materials-Redelegation of .EE.pdf**



Sensitive Delegation Information

Sensitive Delegation Information

Sensitive Delegation Information



Sensitive Delegation Information

Sensitive Delegation Information

**2013-06-27-01d-Reference Materials-Delegation of  
.MOH.pdf**

## Sensitive Delegation Information

Sensitive Delegation Information

Sensitive Delegation Information

Sensitive Delegation Information

Sensitive Delegation Information



## Sensitive Delegation Information

**2013-06-27-01e-Reference Materials-Exhibit A-Cover  
Letter SSAC New Member Ben Butler.doc**



23 May 2013

To: ICANN Board  
From: The SSAC Chair  
Via: The SSAC Liaison to the ICANN Board

The purpose of this letter is to bring you up-to-date on a proposed change to the membership of the Security and Stability Advisory Committee (SSAC) and to provide an explanation for the attached request for Board action. This change is the result of ongoing new member evaluations conducted by the SSAC Membership Committee and approved by the SSAC.

The SSAC Membership Committee considers new member candidates and makes its recommendations to the SSAC. The SSAC has agreed with the Membership Committee's recommendation to nominate Ben Butler as a new member of the SSAC. Ben Butler brings valuable skills to the SSAC. Specifically, he brings his experience as Director of Network Abuse at GoDaddy, a large registrar. Also, Mr. Butler brings experience as a host provider and contacts with other host providers, both of which are needed additions to the SSAC. Finally, he brings his strong knowledge of DNS abuse issues.

The SSAC Membership Committee respectfully requests that the Board appoint Ben Butler to the SSAC. Attached is his resume for your reference.

The SSAC welcomes comments from the Board concerning this request.

Patrik Fältström, SSAC Chair

**2013-06-27-01e-Reference Materials-Exhibit B-Ben Butler  
CV.pdf**

# Ben R. Butler

## Objective

---

I have developed a keen interest in the development and implementation of policy (public and private) relating to abuse, e-crime, and security. I would like to contribute meaningfully to the overall security of the larger internet community through participation in the ICANN Security and Stability Advisory Committee (SSAC).

## Professional Accomplishments

---

### Responsibilities of The Director of Network Abuse – GoDaddy.com

- Develop and update Acceptable Use Policies and Terms of Service for all products and services Go Daddy provides.
- Create, Train, and maintain 24x7x365 Abuse team to investigate and mitigate well over 100,000 complaints per year.
- Advise and work with Executives to create customer-facing and public policy relating to e-crime, security, and resource allocation.
- Evaluate each requested action for suspension against multiple factors to determine the course of action that is the greatest good for the company and all its customers.
- Function as Primary point of contact to assist Law Enforcement agencies from the Local to the International level. Assist agencies in matters relating to the investigation, evidence gathering, and termination of abusive domains, hosting and email accounts.

---

### Public Speaking / Training

- Develop and deliver curriculum for Law Enforcement officers on conducting child abuse investigations involving domains and websites.
- Regular presenter at Anti Phishing Working Group(APWG) and Messaging Anti-Abuse Working Group (MAAWG) and Blackhat Conferences regarding Phishing, Malware, Botnets, and Sinkholing of malicious domains.
- Developed and presented multiple presentations for Legal, Abuse, and Policy decision makers of top Registries and Registrars at all Registrar Summit meetings.
- Responsible for creation and delivery of multiple community presentations in Arizona to educators, industry leaders, and schools. Topics covered include Online Privacy and protection, Identity Theft, Cyber Bullying, and Child Abuse and Exploitation.

---

### Investigation, Detection, and Mitigation Expertise

- Unsolicited messaging in all electronic forms ('spam', text, fax, etc.)
- Phishing and Identity Theft, Brand Abuse, Trademark and Copyright Infringements, etc.
- Malware, Hacking, Botnets, 'Sinkholing', and other Network-level attacks involving domain names.
- Illegal and Objectionable Content issues including Child Abuse and Exploitation, Harassment, Defamation, Illegal Pharmacies, etc.
- DNS-based attacks

---

### Previous Experience / Awards

- Email and User Account Administration (Insight) including roles, permissions, and account security.
- Inventor for US Patent No. 8,086,684 B2 "Detecting and Mitigating Undeliverable Email" in which we developed way to detect and prevent further spam from overloading a

## Ben R. Butler

- commercial email system
- Drafted key revision and additions to multiple pieces of proposed U.S. Legislation that became law, including CAN-SPAM Act [15 U.S.C. § 7701], PROTECT Act of 2008 [18 U.S.C. § 2258], and the ‘Ryan Haight Online Pharmacy Act of 2008 [21 U.S.C. § 827 ], as well as pending revisions to the Online Food Drug and Cosmetics Act[21 U.S.C. § 301 , and numerous CyberSecurity, Privacy, and Cloud Computing Federal legislation bills.

### Employment History

---

01/2004 - Current	Director of Network Abuse	GoDaddy.com, Scottsdale, AZ
11/2002 – 01/2004	Abuse Dept. Manager	GoDaddy.com, Scottsdale, AZ
12/2001 – 11/2002	Abuse Admin	GoDaddy.com, Scottsdale AZ
07/1999 – 12/2001	Network Admin	Insight Enterprises, Tempe, AZ

### Education

---

1997-1999	Computer Science and Business Administration	Mesa Community College, Mesa, AZ
-----------	---	-------------------------------------

### References

---

References are available on request.

**2013-06-27-01f-**

Confidential Employment Matter

Confidential Employment Matter



**2013-06-27-01f-**

Confidential Employment Matter

Confidential Employment Matter

Confidential Employment Matter

**2013-06-27-01f-**

Confidential Employment Matter

Confidential Employment Matter

Confidential Employment Matter

**2013-06-27-02a-Reference Materials-AROS Contract  
Agreement Approval.pptx**

# What is AROS?

- **Automated Registrar Onboarding System**
- The system is intended to provide Registrars with a consistent user interface for managing information about their Registrar and when requesting accreditation by (primarily) gTLD Registries, a workspace in which Registries can manage accreditation requests from Registrars, and an administrative interface that allows an ICANN-designated Administrator to manage AROS.



# Why are we doing this?

- ICANN is engaged in the development of an automated registry onboarding system as requested by the Registry and Registrar stakeholder groups.
- Replaces manual process; allow for scalability
- Enhances Registry and Registrar groups interaction

# Selection Process

- ICANN solicited bids from four vendors: 2 Salesforce consultants and implementation providers, and 2 web application developers.
- The proposals covered 3 options for moving forward:
  - Design and build a new stand alone offering
  - Build a new offering on ICANN's Salesforce instance
  - Purchase intellectual property from a provider who has built similar systems and build a new system on ICANN's Salesforce instance

# Vendor Selected

- Staff selected Solution Street. This option offers ICANN a minimum of feature and date risk while being in the mid-range of costs of the four proposals.
- Contract estimated total cost (including license) - \$650,450
- The work is code-for-hire and ICANN will own the resulting code and intellectually property.
- Estimated timeline:
  - Phase 1 Delivery - August 30
  - Data Migration and rollout during the month of August*
  - Phase 2 Delivery - Oct 31st

# Proposed Resolution

- Whereas, ICANN and Solution Street have negotiated in good faith the terms for a proposed statement of work for the development of the Automated Registrar Onboarding System (AROS);
- Whereas, the Finance Committee has reviewed the terms of the proposed Statement of Work for ICANN;
- Whereas, approval is required to commit ICANN funds in the amount of USD \$650,450;
- Whereas, execution of the agreement enables the development of this tool to support Registries and Registrars accreditation;
- Resolved (\_\_\_\_\_), the Finance Committee authorizes the President and CEO to enter into the proposed agreement with Solution Street.

**2013-06-27-02b-Reference Materials-IDN ccTLD Fast  
Track.doc**

## REFERENCE MATERIALS – 2013.06.27.02b

**SUBMISSION TITLE:           Change IDN ccTLD FT to implement the EPSRP**

**Background:**

The IDN ccTLD Fast Track process was developed by the community as a joint effort by the ccNSO, the GAC and others. It is designed to introduce a limited number of non-contentious IDN ccTLDs associated with the ISO 3166-1 two-letter codes, and to meet near-term demand while the community developed the overall policy for a broader introduction of IDN ccTLDs.

Per the Final Implementation Plan for IDN ccTLD Fast Track Process [FTIP], approved by the ICANN Board at its annual meeting in Seoul, Republic of Korea on 30 October 2009 <http://www.icann.org/en/minutes/resolutions-30oct09-en.htm#2>, the process includes checks for string similarity between applied for strings and existing TLDs and other requested TLDs. This check is part of the DNS Stability Evaluation process performed by an external and independent panel called the DNS Stability Panel.

The work of the DNS Stability Panel consists of two types of evaluations; a technical review of the requested strings in the Fast Track Process for conformity with the IDN ccTLD String Criteria, and a review of the requested strings for confusability with existing TLDs, other TLDs requested in the IDN ccTLD Fast Track Process, and applied-for strings in the new gTLD Program.

The IDN ccTLD Fast Track Process requires a public review of the process each year. To date, the process has undergone two annual reviews. In both reviews, commenters stressed the need to clarify the rules in assessing string similarity. In addition, the GAC communiqué from Prague, Czech Republic, dated 28 June 2012, included advice for the ICANN Board on string similarity assessment under the IDN ccTLD Fast Track process.

The community feedback on string similarity review was an input into the ccNSO IDN ccTLD policy development process. The ccNSO Council has adopted all the PDP proposals during the ICANN Beijing meeting in April 2013. The ccNSO members are currently in the process of voting on the Council Recommendation, which includes all proposals relating to the selection of IDN ccTLD strings. In accordance with the rules for a ccNSO PDP, the GAC has been formally asked to provide advice or an opinion.

To address concerns about the process and at the urgent request of the community to create a mechanism for a further review, the policy recommends a two panel process to complete the string similarity review as defined in the [Final Report IDN ccNSO Policy Development Process](#) (Final Report) dated 29 March 2013.

On 10 April 2013, the ccNSO Council adopted all of the recommendations in the Final Report. The ccNSO Chair sent an email to the ICANN Board of Directors to inform him and to request the “ICANN Board of Directors to implement in the IDN ccTLD Fast Track Process, the two panel process for confusing similarity review as outlined in the report.” (see exhibit C).

## **Proposed changes:**

The IDN ccTLD Fast Track Process was introduced to, amongst others, experiment with a methodology for the selection of IDN ccTLD strings. This methodology would inform the development of the overall policy for the selection of IDN ccTLD strings under the ccNSO IDN ccTLD Policy Development Process. The request of the ccNSO Council is to amend the IDN ccTLD Fast Track process to implement the two-panel string similarity review process in the Fast Track Process. This will allow the testing and refinement, if needed, of the proposed two-panel string similarity review process, in preparation for the implementation of the overall policy for the selection of IDN ccTLDs.

Under the proposed policy, a two panel process will be introduced to validate IDN ccTLD Strings:

- A similarity Review Panel - To validate a selected string is not confusingly similar. ICANN should appoint an external and independent “Similarity Review Panel” to review the selected IDN ccTLD string for confusing similarity.
- Extended Process Similarity Review Panel - To allow for a final validation review relating the confusing similarity, and only if so requested by the requester. ICANN should appoint, an external and independent Extended Process Similarity Review Panel.

If this amendment is approved, the two-step panel string similarity review will function as follows in the IDN ccTLD Fast Track Process: The first step remains exactly the same. The requested string is reviewed for confusability with existing TLDs, other TLDs requested in the IDN ccTLD Fast Track Process, and applied-for strings in the New gTLD Program. If according to this review, the selected IDN ccTLD string is found to present a risk of string confusion, the requestor may call for an Extended Process Similarity Review Panel (EPSRP). The requestor will have three months to notify ICANN of their request to invoke the EPSRP. If used, the EPSRP conducts a second and final evaluation of the string, based on the methodology and criteria defined for the panel, and may ask clarification questions through ICANN staff. The findings of the EPSRP are reported to staff and will be publicly announced on the ICANN website. If the EPSRP does not consider the string to be confusingly similar, the selected IDN ccTLD string is deemed valid.

Implementation of the two-panel process for confusing similarity review in the IDN ccTLD Fast Track Process will result in the following changes:

1. Impact on the DNS Stability Evaluation: The DNS Stability Evaluation process will include an optional additional review resulting in the following three processes:
  - a. A detailed technical check in which compliance with all the technical string requirements is verified.

- b. An evaluation of string similarity with any reserved names, existing or potential TLDs.
  - c. If the string is not deemed valid in step B, the requestor may invoke an additional review by the Extended Process Similarity Review Panel (EPSRP).
2. Documentation update: The published FTIP<sup>1</sup> will be amended to describe the panel changes.
  3. Allow all current applications within the Fast Track Process (including those that are not formally terminated but have failed the current Fast Track string similarity evaluation) to go through the Extended Process Similarity Review Panel (EPSRP), the second half of the two-step string similarity review process. Requestors will be apprised of their eligibility for this additional review when the EPSRP has been constituted and the methodology and criteria for its work has been defined.

### **Key stakeholders and community input:**

The IDN ccTLD Fast Track Process requires a public review of the process each year. To date, the process has undergone two annual reviews. The string similarity topic was the focus of both annual reviews of the IDN ccTLD Fast Track Process. String similarity assessment was also discussed at a public sessions held during the ccNSO session at the ICANN San Francisco meeting in March 2011. A common theme in the reviews and meetings called for clarification of the rules for assessing string similarity.

In addition to the community input received through the annual reviews of the IDN ccTLD Fast Track Process, the GAC communiqué from Prague, Czech Republic, dated 28 June 2012 included advice for the ICANN Board on string similarity assessment under the IDN ccTLD Fast Track process. Their advice included, that proposed IDN ccTLD strings that were not validated for string similarity, “particularly those put forward by public or national authorities should be urgently re-considered... the GAC further advises the Board to create a mechanism of appeal that will allow challenging the decisions on confusability related to proposed IDN ccTLDs.”<sup>2</sup> “ The EPSRP will not introduce an appeals process, it will serve to provide a different type of string similarity review on a separate, scientific basis from the existing string similarity panel.

The ccNSO IDN ccTLD policy development process also had significant community input to better define and enhance the rules for the string similarity review process. According to the proposals as adopted by the ccNSO Council (<http://ccnso.icann.org/workinggroups/idn-ccdpd-final-29mar13-en.pdf>) the DNS Stability Evaluation calls for a functional division into three panels: the Technical Review Panel, the String Similarity Panel and the Extended Process String Review Panel (EPRSP). The function of the EPSRP is to perform a second and final confusing similarity validation of the requested IDN ccTLD string, if the String Similarity Panel deems the string to be invalid. The methodology and criteria of the second validation

<sup>1</sup> <http://www.icann.org/en/resources/idn/fast-track/idn-cctld-implementation-plan-04jun12-en.pdf>

<sup>2</sup> [https://gacweb.icann.org/download/attachments/27131919/FINAL\\_GAC\\_Communique\\_20120628.pdf?version=1&modificationDate=1341949563000&api=v2](https://gacweb.icann.org/download/attachments/27131919/FINAL_GAC_Communique_20120628.pdf?version=1&modificationDate=1341949563000&api=v2)



review should be based on the results of scientific research in character recognition. The proposed policy was available for public comment from 29 August to 9 November 2012 and from 5 February to 21 March 2013. Comments received supported the separation of the evaluation panels.

Staff believes the changes proposed in this paper, which are based on ccNSO policy will be helpful in responding to the community's concerns and will meet the advice received from the Governmental Advisory Committee.

**Resource implications:**

This amendment will have an implication on the fees paid to the panels and for the development of the methodology and criteria to be used by the second panel. Instead of having one panel of experts validate the technical requirements and string similarity, the Fast Track process will have two separate panels.

**Exhibits:**

Exhibit A: [Final Implementation Plan for IDN ccTLD Fast Track Process](#)

Exhibit B: [Final Report IDN ccNSO Policy Development Process](#)

Exhibit C: Email from Lesley Cowley to Steve Crocker

Exhibit D: [GAC Communiqué 28 June 2012 –Prague, Czech Republic, section IV](#)

Exhibit E: [First Annual IDN ccTLD Fast Track Process Review](#)

Exhibit F: [Second Annual IDN ccTLD Fast Track Process Review](#)

Exhibit G: Proposed changes to Final Implementation Plan for IDN ccTLD Fast Track Process

Submitted by: Naela Sarras

Position: Manager, IDN TLDs

Date Noted:

Email and Phone Number [naela.sarras@icann.org](mailto:naela.sarras@icann.org),

Contact  
Information  
Redacted

**2013-06-27-02b-Ref Mat-Exhibit C-Email from Lesley  
Cowley to Steve Crocker.pdf**

**From:** Lesley Cowley <[lesley@nominet.org.uk](mailto:lesley@nominet.org.uk)>  
**Date:** Wednesday, April 10, 2013 9:02 PM  
**To:** Steve Crocker <[steve.crocker@icann.org](mailto:steve.crocker@icann.org)>  
**Cc:** Fadi Chehade <[fadi.chehade@icann.org](mailto:fadi.chehade@icann.org)>, Mike Silber <[mike.silber@icann.org](mailto:mike.silber@icann.org)>, "[chris.disspain@icann.org](mailto:chris.disspain@icann.org)" <[chris.disspain@icann.org](mailto:chris.disspain@icann.org)>, Bart Boswinkel <[bart.boswinkel@icann.org](mailto:bart.boswinkel@icann.org)>  
**Subject:** IDN ccTLD PDP

Dear Steve,

At our meeting on 10 April 2013, the ccNSO Council adopted all of the recommendations contained in the Final Report of the Issue Manager as submitted to the Chair of the ccNSO Council on 1 April 2013 (<http://ccnso.icann.org/node/37899>). This shall be conveyed as the Council Recommendation to the Members of the ccNSO, to vote upon prior to the upcoming Durban meeting.

Taking into account that the IDN ccTLD Fast Track Process was introduced at the time to, amongst others, experiment with the proposed Fast Track methodology, the ccNSO Council accordingly requests the ICANN Board of Directors to implement in the IDN ccTLD Fast Track Process, the two panel process for confusing similarity review, as defined in the Final Report, dated 29 March 2013 (Annex A) and Section 2 of the transitional arrangement of the proposed transitional arrangement regarding IDN ccTLD strings under the Fast Track IDNccTLD Process (Annex B).

The Board is further requested to direct staff to develop further the method and criteria to assess confusing similarity and the additional aspects relating to the roles and responsibilities of the two panels, which will review the confusing similarity aspects of requested strings.

On behalf of the ccNSO Council

Kind regards,  
Lesley

Lesley Cowley, OBE  
Chair

**Annex A Final Report Process for confusing similarity  
Process for confusing similarity validation**

1. After completion of the Technical Validation ICANN staff will submit the selected IDN ccTLD string to the String Similarity Panel for the confusing similarity string evaluation.
2. The Panel shall conduct a confusability string evaluation of the string submitted for evaluation. The Panel may ask questions for clarification through ICANN staff.
3. The findings of the evaluation will be reported to ICANN staff. In the report the Panel will include the names of the Panelists, document the decision and provide the rationale for the decision. Where the string is considered to be confusingly similar the report shall at a minimum include a reference to the string(s) to which the confusing similarity relates and examples (in fonts) where the panel observed the similarity. ICANN staff shall inform and notify the requester accordingly. Usually the Panel will conduct its review and send its report to ICANN staff within 30 days after receiving the IDN ccTLD string to be evaluated. In the event the Panel expects it will need more time, ICANN staff will be informed. ICANN staff shall inform the requester accordingly.
- 4 a. If according to the review, the Panel does not consider the string to be confusingly similar, the selected IDNccTLD is validated.
- 4 b. If according to the review the selected IDN ccTLD string presents a risk of string confusion with one particular combination of two ISO 646 Basic Version (ISO 646-BV) characters and this combination is according the ISO 3166 standard the two-letter alpha-2 code associated with same Territory as represented by the selected string, this should be noted in the report. ICANN staff shall inform the requester accordingly.

If, within 3 months of receiving the report the requestor shall confirm that:  
(i) The intended manager and intended registry operator for the IDN ccTLD and the ccTLDmanager for the confusingly similar

- country code are one and the same entity; and
- (ii) The intended manager of the IDN ccTLD shall be the entity that requests the delegation of the IDNccTLD string; and
- (iii) The requester, intended manager and registry operator and, if necessary, the relevant public authority, accept and document that the IDN ccTLD and the ccTLD with which it is confusingly similar will be and will remain operated by one and the same manager, and
- (iv) The requester, intended manager and registry operator and, if necessary, the relevant public authority agree to specific and pre-arranged other conditions with the goal to mitigate the risk of user confusion as of the moment the IDN ccTLD becomes operational;

then the IDN ccTLD string is deemed to be valid.

If either the requester, intended manager or the relevant public authority do not accept the pre-arranged conditions within 3 months after notification or at a later stage refutes the acceptance, the IDN ccTLD shall not be validated.

Alternatively, the requester may defer from this mechanism and use the procedure as described under 4 c.

#### 4c.

- i. If according to the review the selected IDN ccTLD string is found to present a risk of string confusion, ICANN staff shall inform the requester in accordance with paragraph 3 above. The requester may call for an Extended Process Similarity Review and provide additional documentation and clarification referring to aspects in the report of the Panel. The requester should notify ICANN within three (3) calendar months after the date of notification by ICANN, and include the additional documentation. After receiving the notification from the requester, ICANN staff shall call on the Extended Process Similarity Review Panel (EPSRP).
- ii. The EPSRP conducts its evaluation of the string, based on the standard and methodology and criteria developed for it, and, taking into account, but not limited to, all the related documentation from the requester, including submitted additional documentation, IDN tables available, and the finding of the Similarity Review Panel. The EPSRP may ask questions for clarification through ICANN staff.

iii. The findings of the EPSRP shall be reported to ICANN staff and will be publicly announced on the ICANN website. This report shall include and document the findings of the EPSRP, including the rationale for the final decision, and in case of the risk of confusion a reference to the strings that are considered confusingly similar and examples where the panel observed this similarity.

If according to the Extended Process Similarity Review, the EPSRP does not consider the string to be confusingly similar the selected IDN ccTLD is valid.

## Annex B

### **D. Transitional arrangement regarding IDN ccTLD strings under the Fast Track IDN ccTLD Process**

1.

Closure of Fast Track Process. Upon implementation of the policy for the selection of IDN ccTLDs by ICANN, the policy for selection of IDN ccTLDs only applies to new requests, unless a requester indicates otherwise.

2.

If an IDN ccTLD string request submitted under the Fast Track Process is still in process or has been terminated due to non-validation of the string, the requester may within three months after implementation of the policy request a second, final validation review by the Extended Process Similarity Review Panel .

**2013-06-27-02b-Ref Mat-Exhibit G - Proposed changes to  
Final Implementation Plan for IDN ccTLD Fast Track  
Process.pdf**



Editor 6/19/13 2:49 PM

Deleted: 4 June 2012

# Final Implementation Plan for IDN ccTLD Fast Track Process

**Revised on xx Month 2013**

Updated to include Extended Process Similarity Review Panel

## **Document Revision History:**

- A link to the original Implementation Plan published on 16 November 2009 may be found at:  
<http://www.icann.org/en/topics/idn/fast-track/idn-ccTld-implementation-plan-16nov09-en.pdf>
- A link to the Revised Implementation Plan published on 15 December 2011 may be found at:  
<http://www.icann.org/en/resources/idn/fast-track/idn-ccTld-implementation-plan-15dec11-en.pdf>
- A link to the Revised Implementation Plan published on 4 June 2012 may be found at: <link>

*Previous versions are archived and superseded by the document below.*

1



# Table of Contents

<b>Module 1</b> .....	3
General Introduction.....	3
<b>Module 2</b> .....	4
Country/Territory Eligibility Requirements.....	4
2.1 ISO 3166-1 Representation.....	4
2.2 Submission of an IDN ccTLD request by eligible country/territory.....	4
Appendix 1 to Module 2.....	6
<b>Module 3</b> .....	7
TLD String Criteria and Requirements.....	7
3.1 General String Criteria.....	7
3.2 Language and Script Criteria.....	7
3.3 String Meaningfulness Requirement.....	8
3.4 Number of Strings per Country or Territory.....	9
3.5 Technical String Criteria.....	10
3.5.1 Technical String Requirements.....	11
Appendix 1 to Module 3.....	13
<b>Module 4</b> .....	15
DNS Stability Evaluation.....	15
4.1 String Evaluation.....	15
4.2 DNS Stability Panel Function.....	16
4.3 Extended Process Similarity Review Panel Function.....	17
4.3.1 EPSRP Framework.....	18
<b>Module 5</b> .....	19
Request Submission Stages for String Evaluation.....	19
5.1 General Fast Track Process Overview.....	19
5.1.1 Preparation (Stage 1).....	19
5.1.2 Request Submission for String Evaluation (Stage 2).....	20
5.1.3 Request Submission for Delegation Evaluation (Stage 3).....	20
5.2 Submission of an IDN ccTLD Fast Track Request.....	21
5.3 ICANN Staff Support and Contact Functions.....	22
5.3.1 General Contact Details.....	22
5.3.2 Specific IDN Support Details.....	22
5.4 Termination of Submitted Requests.....	23
5.5 String Confusion and Contention.....	24
5.6 Processing of a Fast Track Request.....	25
5.6.1 Request Completeness Validation.....	25
5.6.2 Linguistic Validation.....	26
5.6.3 DNS Stability Evaluation.....	27
5.6.4 Public Posting of Validated String(s).....	28
5.6.5 IANA Delegation Readiness.....	29
Appendix 1 to Module 5.....	30
Appendix 2 to Module 5.....	37
<b>Module 6</b> .....	38
Delegation Process.....	38
6.1 IANA Function.....	38
6.1.1 Operational and Technical Skills.....	38
6.1.2 Manager in Country.....	38
6.1.3 Equitable Treatment.....	39
6.1.4 Community/Governmental Support.....	39
6.2 ICANN Board Review Process.....	39
6.3 US Government Authorization.....	39
<b>Module 7</b> .....	40
Relationship between IDN ccTLD Manager and ICANN.....	40
Appendix 1 to Module 7.....	41
<b>Module 8</b> .....	55
Fee Structure and Model.....	55
Appendix 1 to Module 8.....	57
<b>Module 9</b> .....	58
Process Review and Revision.....	58
Review Schedule.....	58
<b>Module 10</b> .....	59
Background Information.....	59

2

Deleted: 34
Nicoleta Munteanu 6/19/13 2:58 PM
Deleted: 34
Nicoleta Munteanu 6/19/13 2:58 PM
Deleted: 45
Nicoleta Munteanu 6/19/13 2:58 PM
Deleted: 45
Nicoleta Munteanu 6/19/13 2:58 PM
Deleted: 45
Nicoleta Munteanu 6/19/13 2:58 PM
Deleted: 45
Nicoleta Munteanu 6/19/13 2:58 PM
Deleted: 67
Nicoleta Munteanu 6/19/13 2:58 PM
Deleted: 78
Nicoleta Munteanu 6/19/13 2:58 PM
Deleted: 78
Nicoleta Munteanu 6/19/13 2:58 PM
Deleted: 78
Nicoleta Munteanu 6/19/13 2:58 PM
Deleted: 78
Nicoleta Munteanu 6/19/13 2:58 PM
Deleted: 89
Nicoleta Munteanu 6/19/13 2:58 PM
Deleted: 910
Nicoleta Munteanu 6/19/13 2:58 PM
Deleted: 1011
Nicoleta Munteanu 6/19/13 2:58 PM
Deleted: 1112
Nicoleta Munteanu 6/19/13 2:58 PM
Deleted: 1314
Nicoleta Munteanu 6/19/13 2:58 PM
Deleted: 1516
Editor 6/19/13 2:49 PM
Deleted: Panel
Nicoleta Munteanu 6/19/13 2:58 PM
Deleted: 1516
Nicoleta Munteanu 6/19/13 2:58 PM
Deleted: 16
Nicoleta Munteanu 6/19/13 2:58 PM
Deleted: 1517
Nicoleta Munteanu 6/19/13 2:58 PM
Deleted: 18
Nicoleta Munteanu 6/19/13 2:58 PM
Deleted: 19
Nicoleta Munteanu 6/19/13 2:58 PM
Deleted: 1720
Nicoleta Munteanu 6/19/13 2:58 PM
Deleted: 1720
Nicoleta Munteanu 6/19/13 2:58 PM
Deleted: 1720
Nicoleta Munteanu 6/19/13 2:58 PM
Deleted: 1720
Nicoleta Munteanu 6/19/13 2:58 PM
Deleted: 1821
Nicoleta Munteanu 6/19/13 2:58 PM
Deleted: 1821
Nicoleta Munteanu 6/19/13 2:58 PM
Deleted: 1922
Nicoleta Munteanu 6/19/13 2:58 PM
Nicoleta Munteanu 6/19/13 2:58 PM
Nicoleta Munteanu 6/19/13 2:58 PM
Nicoleta Munteanu 6/19/13 2:58 PM
Editor 6/19/13 2:49 PM
Nicoleta Munteanu 6/19/13 2:58 PM
Nicoleta Munteanu 6/19/13 2:58 PM
Nicoleta Munteanu 6/19/13 2:58 PM
Nicoleta Munteanu 6/19/13 2:58 PM
Nicoleta Munteanu 6/19/13 2:58 PM

# Module 1

## General Introduction

This is the Final Implementation Plan for the IDN ccTLD Fast Track Process.

The plan is based on recommendations provided by the [IDNC Working Group \(WG\) in its Final Report](#) as well as on public comments provided throughout the IDNC WG's online and public comment facilities and on public comments received on the previous draft versions of the plan. For a full overview of consultations and review see Module 10.

The plan is presented in modules as follows:

Module 1: General Introduction

Module 2: Fast Track Eligibility Requirements

Module 3: TLD String Criteria and Requirements

Module 4: DNS Stability [Evaluation](#)

Module 5: Request Submission & String Evaluation

Module 6: Request Submission for Delegation Evaluation

Module 7: Relationship between IDN ccTLD and ICANN

Module 8: Fee Structure and Model

Module 9: Process Review and Revision

Module 10: Background Information

The plan was [approved by the ICANN Board](#) at their meeting in Seoul, South Korea, 30 October 2009, by the following resolution:

*Resolved (2009.10.30\_\_), the ICANN Board sincerely thanks all participants for their hard work towards making IDN TLDs become a reality through the IDN ccTLD Fast Track Process;*

*Resolved (2009.10.30\_\_), the ICANN Board directs staff to launch the IDN ccTLD Fast Track process as detailed in the Proposed Final Implementation Plan, beginning at 00:00 UTC on 16 November 2009;*

*Resolved (2009.10.30\_\_), the ICANN Board directs staff to monitor the operation of the IDN ccTLD Fast Track process at regular intervals to ensure its smooth operation, and, subject to Board review, update the process when new technology or policies become available, with the goal to efficiently meet the needs of Fast Track process requesters, and to best meet the needs of the global Internet community.*

Editor 6/19/13 2:49 PM

Deleted: Panel

# Module 2

## Country/Territory Eligibility Requirements

Participation in the IDN ccTLD Fast Track Process is limited in accordance with the IDNC WG recommendations and as discussed in this module. The recommendations and their inherent limitations were arrived at through community consultations as described in Module 10. The primary reasons for implementing limitations are that the process is experimental<sup>1</sup> in nature and should not pre-empt the outcome of the ongoing IDN ccNSO Policy Development Process. Limitation aspects related to the string criteria and requirements are presented in Module 3.

### 2.1 ISO 3166-1 Representation

To be eligible to enter the IDN ccTLD Fast Track Process the country or territory must be listed in the International Standard ISO 3166-1 (Codes for the representation of names and countries and their subdivisions – Part 1: Country Codes). The exception to this requirement is the additional eligibility of the European Union which has an exceptionally reserved code designated by the ISO 3166 Maintenance Agency (see [http://www.iso.org/iso/support/country\\_codes/iso\\_3166\\_code\\_lists/iso-3166-1\\_decoding\\_table.htm#EU](http://www.iso.org/iso/support/country_codes/iso_3166_code_lists/iso-3166-1_decoding_table.htm#EU)) and has also been deemed eligible under ICANN policy for a country-code top-level domain.

A country or territory represented on the ISO3166-1 list is eligible to participate in the IDN ccTLD Fast Track Process and to request an IDN ccTLD string that fulfills the additional requirements set forth in Module 3.

### 2.2 Submission of an IDN ccTLD request by eligible country/territory

The Fast Track Process is divided into three distinct stages as discussed in more detail in Module 5:

- Stage 1: Preparation Stage
- Stage 2: Request Submission for String Evaluation and
- Stage 3: Request Submission for Delegation Evaluation.

The entity acting as the requester and that submits the request for an IDN ccTLD to ICANN for stage 2 can be the identified IDN ccTLD manager (proposed sponsoring organization) or the relevant government or public authority or their designated representative.

If the requester is the IDN ccTLD manager (this may be the existing country-code top-level domain manager for the ISO 3166-1 code or a different entity) or government designated representative they must have the support from the country or territory corresponding to the relevant ISO 3166-1 entry and must

---

<sup>1</sup> It is important to note that by 'experimental' the working group was commenting on the policy aspects of IDN introduction and not the technical aspects. IDNs have been tested in the root zone and technical implications of the introduction are generally well understood. All studies will be completed to ensure there is a full understanding that IDNs will have no deleterious effects on DNS interoperability, stability and security.

satisfactorily and clearly document this support. The documentation of support must evidence support from the relevant government or public authority. This is defined as a signed letter of support: from the Minister with the portfolio responsible for domain name administration ICT foreign affairs or Office of the Prime Minister or President or from a senior representative of the agency or department responsible for domain name administration ICT Foreign Affairs or the Office of the Prime Minister.

The letter should clearly express the government or public authority's support for the request and demonstrate the government or public authority's understanding of the string being requested and its intended use. The letter should also demonstrate the government or public authority's understanding that the string is being sought through the IDN ccTLD Fast Track Process and that the requester is willing to accept the conditions under which the string will be available i.e. as outlined in this Final Implementation Plan.

If there is reason for doubt of the authenticity of the letter ICANN will consult with the relevant diplomatic authorities or members of the GAC for the government or public authority concerned.

To further assist the requester in determining who the relevant government or public authority may be for a request the requester may wish to consult with the relevant GAC representative. See <https://gacweb.icann.org/display/gacweb/GAC+Representatives>

An example of a support letter is included in Appendix 1 to this Module 2.

# Appendix 1 to Module 2

---

## *Sample: Documentation of support for the request from the government or relevant public authority for the country or territory.*

---

The IDN ccTLD request must be either from the government or relevant public authority or support from the government or public authority must be included in the request.

This is a guiding example of what such documentation of support can look like:

To: ICANN  
12025 Waterfront Drive Suite 300  
Los Angeles CA 90094-2536  
USA  
  
Attention: IDN ccTLD Fast Track Request

[location date]

Subject: Letter of Support for [U-label/A-label] request to ICANN Fast Track Process:

This letter is to confirm that the [public authority for country/territory] fully supports the Fast Track request to ICANN conducted by [Requester] for the string(s) [A-label/U-label] to be used as an IDN ccTLD representing [country/territory name] on the Internet.

It is further confirmed that the name is being sought through the ICANN IDN ccTLD Fast Track Process and that the [Requester] is willing to accept the conditions under which the string will be available as outlined in the Final Implementation Plan for the IDN ccTLD Fast Track Process.

Sincerely

Signature from relevant public authority

Name of individual  
Title of individual  
Name of department or office  
Postal Address  
Telephone  
Email address

# Module 3

## TLD String Criteria and Requirements

---

A conservative approach for potential IDN ccTLD strings has been adopted because of the Fast Track Process' limited introductory nature and to safeguard against pre-empting the outcome of the ongoing IDN ccNSO Policy Development Process. Limitations in this module are focused on criteria and requirements set for the TLD string.

### 3.1 General String Criteria

---

The following contains some clarifications about the general criteria for a requested IDN ccTLD string:

1. the string must be a minimum of two characters long (U-label)
2. characters are counted as basic Unicode components
3. the string does not need to be the entire country or territory name nor does it need to be an acronym as long as the string fulfills the meaningfulness criteria described further below
4. the string must not be longer than 63 characters (A-label).

ICANN is not responsible for IDN usability issues in applications. The usability of IDNs may be limited as not all application software is capable of working with IDNs. It is up to each application developer to decide whether or not they wish to support IDNs. This can include for example browsers email clients and sites where you enlist for a service or purchase a product and where the process involves entering an email address. Such usability problems currently exist today with the ASCII TLDs in some situations where the TLD string is longer than three characters.

Further acceptability and usability issues may occur as the IDNA protocol standard is revised and as the IDN protocol for email management is finalized in the Internet Engineering Task Force (IETF). The result of the IDNA protocol revision is that some characters previously not permitted within IDNs are now valid. ICANN will accept requests for strings with these newly-valid characters but until the new revised standard is implemented and broadly adopted by relevant application developers users may experience problems with using the IDN. This may have different results in different applications and in some instances a user may experience no functionality at all. It would be appropriate for all IDN TLD managers to provide their users with information about the limitations of use of IDNs and at the same time promote the use of IDNs to achieve global IDN implementation across applications. ICANN supports such efforts but is not able to enforce or require them.

### 3.2 Language and Script Criteria

---

The conditions for allowable languages and scripts to be used for the requested TLD string are as follows:

The language must be an official language in the corresponding country or territory and have legal status in the country or territory or serve as a language of administration.

The language requirement is considered verified as follows:

- If the language is listed for the relevant country or territory as an ISO 639 language in Part Three of the *Technical Reference Manual for the standardization of Geographical Names, United Nations Group of Experts on Geographical Names* ("UNGEGN Manual") (<http://unstats.un.org/unsd/geoinfo/UNGEGN/publications.html>) or
- If the language is listed as an administrative language for the relevant country or territory in the ISO 3166-1 standard under column 9 or 10 or
- If the relevant public authority in the country or territory confirms that the language is used or served as follows (either by letter or link to the relevant government constitution or other online documentation from an official government website):
  - a. used in official communications of the relevant public authority and
  - b. serves as a language of administration.

Languages based on the Latin script are not eligible for the Fast Track Process. That is the requested string must not contain the characters (a ... z) either in their basic forms or with diacritics.

An example of a letter confirming that the language used is official is included for guidance see Appendix 1 to this Module 3.

### **3.3 String Meaningfulness Requirement**

---

The IDN ccTLD string(s) must be a meaningful representation of the name of the corresponding country or territory. A string is deemed to be meaningful if it is in the official language of the country or territory and if it is:

- The name of the country or territory or
- A part of the name of the country or territory denoting the country or territory or
- A short-form designation for the name of the country or territory that is recognizable and denotes the country or territory in the selected language.

The meaningfulness requirement is verified as follows:

1. If the requested string is listed in the [UNGEGN Manual](#) then the string fulfills the meaningfulness requirement.
2. If the requested string is not listed in the UNGEGN Manual then the meaningfulness must be substantiated by the requester by providing documentation from an internationally recognized expert or organization.

ICANN will recognize the following as internationally recognized experts or organizations:

- a. National Naming Authority – a government recognized National Geographic Naming Authority or other organization performing the same function for the country or territory for which the IDN ccTLD Fast Track request is presented. The United Nations Group of Experts on Geographical Names (UNGEGN) maintains such a list of organizations at: <http://unstats.un.org/unsd/geoinfo/ungean/ungeanSession25.html>
- b. National Linguistic Authority – a government recognized National Linguistic Authority or other organization performing the same function for the country or territory for which the IDN ccTLD Fast Track request is presented.
- c. ICANN agreed ~~expert or organization~~ – in the case where a country or territory does not have access to either of the above it may request assistance from ICANN to identify and refer a recognized expert or organization. Any expertise referred from or agreed to by ICANN will be considered acceptable and sufficient to determine whether a string is a meaningful representation of a country or territory name.

This assistance can be requested by contacting ICANN at:  
[idnccldrequest@icann.org](mailto:idnccldrequest@icann.org)

An example of a letter from an international recognized expert or organization confirming the meaningfulness of the requested string is attached for guidance: see Appendix 1 to this Module 3.

### **3.4 Number of Strings per Country or Territory**

---

The number of strings that a country or territory can apply for is not limited to a specific number (in accordance with Guiding Principle G in the IDNC WG Final Report). However the following maximum limitation applies:

- One string per official language or script per country or territory.

This limitation may cause issues for some countries and territories which have expressed the importance of having variant TLDs allocated and delegated in the DNS.

The topic of delegation of variant TLDs and management of variant TLDs has been discussed broadly in the community. ICANN staff has proposed a few models none of which were agreeable across the policy and technical community reviewing the topic.

In order to stay within ICANN's mandate for ensuring a stable and secure operation of the Internet the following will be the case for the Fast Track Process launch:

- Variant TLDs desired by the requester for delegation must be indicated by the requester
- Desired variant TLDs will be allocated to the requester (if successfully evaluated). This does not mean that the variant TLD will be delegated in the DNS root zone. It will be allocated to the requester in order to be reserved to the entitled manager for potential future delegation in the DNS root zone.

Editor 6/19/13 2:49 PM

Deleted: expertor



- A list of non-desired variants will be generated based on the received IDN Tables. Non-desired variants will be placed on a blocked list by ICANN.

Subsequent application or request for non-desired variants will be denied.

The community is expected to continue working on more clear definitions of variants solutions or methods for delegation of variants and any necessary dispute mechanisms related to disagreement regarding desired and non-desired variants. For the purpose of including new development in the Fast Track Process it is scheduled for revision. (See Module 9 for more details)

### **3.5 Technical String Criteria**

---

This section describes technical criteria for IDN ccTLD strings. Other technical requirements related to delegation (such as name server requirements) are considered in Module 6.

Meeting all the technical string requirements in this section does not guarantee acceptance of a prospective top-level string since the following subsections do not contain an exhaustive list of all requirements or restrictions. Technical requirements for IDN ccTLD strings and IDN gTLD strings are equivalent and are established by technical standards developed by the IETF.

In August 2010 the IETF finalized the current specification for the IDNA protocol. This specification sometimes referred to as "IDNS2008" differs from the earlier "IDNA2003" version of the protocol. It changes the list of characters that may be included in an IDN reflecting additions made to Unicode standard and eliminating a number of symbols and other marks that are not used for writing words in any language (and which were invalid characters in an IDN per the IDN Guidelines). The following remarks are intended to clarify for prospective requesters the key differences between the original and current versions of the protocol particularly as they relate to TLDs.

The main technical detail that a name holder needs to address is the conversion of a name from its U-label form (as displayed using Unicode characters) to its A-label form (as stored in the DNS with a sequence of ASCII characters). ICANN requires both such strings in a request for an IDN ccTLD. Tools are available that permit this conversion to be done using the current version of the protocol. One particularly noteworthy distinction is that IDNA2003 can change a U-label during the round-trip conversion from U-label to A-label and back to U-label whereas IDNA2008 never "maps" any character in a U-label to some other character.

Only labels that are valid under IDNA2008 will be allowed. The implementation of IDNA2008 in the broader software applications environment is occurring gradually. During this time TLD labels that are valid under IDNA2008 but not under IDNA2003 may have limited functionality. Conversely labels that are valid under IDNA2003 but not under IDNA2008 will become increasingly dysfunctional. Labels of the latter type will therefore not be permitted for TLDs and requests for such strings will be declined. Requesters are strongly advised to note that the duration of the transition period between the two protocols cannot presently be estimated nor guaranteed in any specific timeframe.

### 3.5.1 Technical String Requirements

---

The following are general technical requirements that must be complied with for the IDN ccTLDs in A-label<sup>2</sup> format.

- The A-label (i.e. the label as transmitted on the wire) must be valid as specified in technical standards for *Domain Names: Implementation and Specification* (RFC 1035) and *Clarifications to the DNS Specification* (RFC 2181). This includes:
  - o The label must have no more than 63 characters. This includes the prefix (the four initial characters "xn--").
  - o Upper and lower case characters are considered to be syntactically and semantically identical.
- The A-label must be a valid host name as specified in technical standard *DOD Internet Host Table Specification* (RFC 952) and *Requirements for Internet Hosts — Application and Support* (RFC 1123). This includes:
  - o The label must consist entirely of letters, digits and hyphens.

The requester is expected to be familiar with the IETF IDNA standards, Unicode standards, and IDN terminology.

- The string must be a valid internationalized domain name as specified in technical standards <http://www.icann.org/en/topics/idn/rfcs.htm> or any revisions of this technical standard currently under consideration by the IETF as discussed above. The following is presented as guidelines only and are not a complete statement of the requirements for IDNA specifications. The string:
  - o Must contain only Unicode code points that are defined as "Protocol Valid" and be accompanied by unambiguous contextual rules where necessary.
  - o Must be fully compliant with Normalization Form C as described in *Unicode Standard Annex #15: Unicode Normalization Forms*. Examples appear in <http://unicode.org/faq/normalization.html>
  - o The string must consist entirely of characters with the same directional property. This requirement may change as the IDNA protocol is being revised to allow for characters having no directional property (as defined at <http://unicode.org/Public/UNIDATA/extracted/DerivedBidiClass.txt>) to be available along with either a right-to-left or a left-to-right directionality.
  - o The string must not begin or end with a digit (in any script).
- The string must meet the criteria of the current or any subsequent versions of the *ICANN Guidelines for the Implementation of Internationalized Domain Names*. This includes:

---

<sup>2</sup> A domain name consists of a series of "labels" (separated by "dots"). The ASCII form of an IDN label is termed an "A-label". All operations defined in the DNS protocol use A-labels exclusively. The Unicode form, which a user expects to be displayed, is termed a "U-label".

- All code points in a single string must be taken from the same script as determined by the *Unicode Standard Annex #24: Unicode Script Property*.

Exceptions to this guideline are permissible for languages with established orthographies and conventions that require the commingled use of multiple scripts. However even with this exception visually confusable characters from different scripts will not be allowed to coexist in a single set of permissible code points unless a corresponding policy and character table are clearly defined. Further the IDN Guidelines contain a requirement for IDN registries to develop IDN Tables. The IDN Table(s) must be submitted to ICANN with a request for an IDN ccTLD.

The IDN ccTLD requesters are encouraged to:

1. Use and refer to already existing IDN Tables
2. Cooperate in development of the IDN Table(s).

# Appendix 1 to Module 3

---

## *Sample: Documentation that the selected language(s) is considered official in the country/territory.*

---

The IDN ccTLD string(s) that is requested through the Fast Track Process must be in an official language of the corresponding country or territory. A language can be demonstrated to be official if the relevant public authority in the country or territory confirms that the language is used in official communications of the relevant public authority and serves as a language of administration.

This is a guiding example of what such correspondence can look like:

---

To: ICANN  
12025 Waterfront Drive Suite 300  
Los Angeles CA 90094-2536  
USA

[location date]

Subject: Confirmation of Official Language for ICANN Fast Track

This letter is to confirm that language X (ISO 639 code = XX) in conjunction with script Y (ISO 15924 code = ZZZY) is used in official communications by the government of "country 1" (ISO3166-1 code = AA) and serves as a language of administration.

Sincerely

Signature from relevant public authority  
Name of individual  
Title of individual  
Name of department or office  
Postal Address  
Telephone  
Email address

*Sample: Documentation that demonstrates the requested string(s) is a meaningful representation of the corresponding country/territory.*

The IDN ccTLD string(s) that is requested through the Fast Track Process must be a meaningful representation of the corresponding country or territory name.

A string can be demonstrated to be meaningful based on a report from an internationally recognized linguistic expert(s) or internationally recognized organization establishing that the selected string meets the criteria.

This is a guiding example of what such correspondence can look like:

-----  
To: ICANN  
12025 Waterfront Drive Suite 300  
Los Angeles CA 90094-2536  
USA

[location date]

Subject: IDN ccTLD string meaningfulness report developed for [A-label/U-label]

This report has been developed for:

[insert contact details for the requester]

In the expert's opinion the string [A-label/U-label] constitutes a meaningful representation of the country/territory name [insert name]. The detailed information relating to this assessment is as follows:

Country/territory name = [insert]  
ISO 3166-1 code = [insert]  
A-label = [insert]  
U-label = [insert]  
Meaning of the name (string) in English = [list]  
ISO 639 language code = [insert]  
ISO 15924 script code = [insert]

In the expert's opinion the requested IDN ccTLD string is considered a meaningful [acronym/abbreviation/other] of the country/territory name. In the evaluation of the meaningfulness of the string the following justification has been used:

The string is officially recognized as the name of the country by the government/public authority per the following decrees: [insert explanation]

The string is used as a second level domain name under the ISO3166-1 ccTLD for Country 1 and is registered to the government of Country 1.

[insert other justifications as applicable]

[Insert signature from linguistic expert(s)/organization]

# Module 4

## DNS Stability Evaluation

### 4.1 String Evaluation

The role and responsibility of the DNS Stability Evaluation is to provide external and independent advice to the ICANN Board about whether based on the documentation provided by the IDN ccTLD requester a selected string meets the required technical criteria, and is not confusingly similar to other existing or applied for TLDs. If according to the DNS Stability Evaluation the selected string does not meet one or more of the technical criteria or is considered confusingly similar to another string the request for the IDN ccTLD with that particular selected string is not eligible under the Fast Track Process. The DNS Stability Evaluation includes the following evaluations:

- To evaluate a string for the technical requirements an external and independent "Technical Panel" conducts a technical review of the selected IDN ccTLD string.
- To evaluate a string for string similarity an external and independent "Similarity Review Panel" conducts a review of the selected IDN ccTLD string.
- To evaluate a string for string similarity if found to be confusingly similar by the "Similarity Review Panel" and using a different framework an external and independent "Extended Process Similarity Review Panel" (hereafter: EPSRP) conducts a review of the selected IDN ccTLD string only if so requested by the requester.

The "Technical Panel" and "Similarity Review Panel" evaluations are currently combined under the function of the DNS Stability Panel.

The DNS Stability Panel will conduct the review of requested strings in the Fast Track Process for conformity with the TLD String Criteria. The Panel will also review requested strings for confusability with existing TLDs other TLDs requested in the IDN ccTLD Fast Track Process and applied-for strings in the new gTLD Process.

If according to the string similarity review the requested string is deemed to be invalid the EPSRP may be requested by the requester to allow for a final validation review of the string's confusing similarity. The requester will have three months to notify ICANN of their request to invoke the EPSRP. If used the EPSRP conducts a second and final evaluation of the string based on the methodology and criteria defined for the panel in section 4.3 and may ask clarification questions through ICANN staff.

To perform the final string similarity review and only at the request of the requester ICANN will request an external and independent review by the EPSRP. The EPSRP performs its evaluation on the basis of the framework described in section 4.3.1 and takes into account all the related documentation from the requester including submitted additional documentation IDN tables available and the findings of the DNS Stability Panel.

Editor 6/19/13 2:49 PM

Deleted: Panel

Editor 6/19/13 2:49 PM

Deleted: Panel

Editor 6/19/13 2:49 PM

Deleted: .

Editor 6/19/13 2:49 PM

Deleted: Panel finds that

Editor 6/19/13 2:49 PM

Deleted: However the Panel can seek further clarification from the requester via ICANN staff if deemed necessary by the Panel before providing its findings on the requested string.

Editor 6/19/13 2:49 PM

Deleted: ICANN will secure the services of a competent DNS Stability Panel to make technical stability evaluations. In their actions and statements as Panel members these experts do not represent either their affiliated organizations or the country in which they reside in any way.

Editor 6/19/13 2:49 PM

Moved down [1]: ICANN has contracted with Interisle Consulting Group (<http://www.interisle.net/>) to coordinate the DNS Stability Panel.

Editor 6/19/13 2:49 PM

Deleted: The Panel will consist of six experts with the ability of the Panel to call upon linguistic expertise in consultation with ICANN. ICANN will create batches of strings received for the Fast Track Process on a monthly basis starting one month following the launch of the process and deliver the batches to the Panel for review. ... [1]

Editor 6/19/13 2:49 PM

Deleted: ICANN will create strings received for the Fast Track Process on a monthly basis starting one month following the launch of the process and deliver the batches to the Panel for review. ... [2]

The findings of the EPSRP are reported to the ICANN staff and will be publicly announced on the ICANN website. If the EPSRP does not consider the string to be confusingly similar the selected IDN ccTLD string is deemed valid.

ICANN will secure the services of competent Panel to perform the final confusing similarity validation of the requested IDN ccTLD string. The EPSRP includes at a minimum specialists in research in character recognition.

The DNS Stability evaluation process and procedures are described in more detail in Module 5 section 5.6.3

## 4.2 DNS Stability Panel Function

A core piece of the IDNC WG Final Report is technical recommendations to ensure stable and secure operations of the DNS. These technical requirements are outlined in Module 3. All requests in the Fast Track Process must successfully pass a DNS Stability **Review** for the requested IDN ccTLD string to continue through the Fast Track Process.

The DNS Stability Panel conducts an initial evaluation on all strings submitted in the Fast Track Process.

ICANN has contracted with Interisle Consulting Group (<http://www.interisle.net/>) to coordinate the DNS Stability Panel. This Panel consists of six experts with the ability of the Panel to call upon linguistic expertise in consultation with ICANN.

Members of the DNS Stability Panel are experts in the design management and implementation of the complex systems and standards-protocols utilized in the Internet infrastructure and DNS. Panel members have expertise in the technology and practical implementation and deployment of the DNS in the Internet and knowledge of Internationalized Domain Names and the IDNA Protocol.

ICANN creates batches of strings received for the Fast Track Process on a monthly basis and submits the batches to the DNS Stability Panel for review.

If the Panel identifies that a requested string may raise significant security and stability issues or is confusingly similar to an existing TLD or applied-for TLD a three-member extended review team (RT) may be created to conduct a more detailed evaluation of the string. Such detailed review may be conducted when the entire Panel lacks sufficient expertise to determine whether the requested string raises significant security and stability issues but this is expected to be a rare occurrence. The RT may decide the need for additional expertise and may select a new individual expert to take part in the extended review. In the event that a need for linguistic expertise is identified the Panel will consult with ICANN staff on linguistic resources.

Usually the Panel will conduct its review within 30 days and deliver a report to ICANN staff.

The Panel may seek clarification from the requester through ICANN staff if necessary. A more detailed review is likely not to be necessary for a string that fully complies with the string requirements referenced in Module 3. However the string review process provides an additional safeguard if unanticipated security or stability issues arise concerning a requested IDN ccTLD string.

Editor 6/19/13 2:49 PM  
**Deleted:** Panel review

Editor 6/19/13 2:49 PM  
**Deleted:** entire

Editor 6/19/13 2:49 PM  
**Moved (insertion) [1]**

Editor 6/19/13 2:49 PM  
**Deleted:** ... [3]

If the Panel determines that the requested string does not comply with relevant standards or creates a condition that may adversely affect the throughput response time consistency or coherence of responses to Internet servers or end systems then the findings will be communicated to ICANN staff and from ICANN staff to the requester.

The request for an IDN ccTLD cannot proceed through the Fast Track Process if as part of the the technical review process the Panel identifies that a requested string raises significant security and stability issues.

If as a result of the string similarity review the Panel deems the string to be invalid the request can not proceed through the Fast Track Porcess unless the requester initiates the EPSRP evaluation within the 3 months upon notification. The EPSRP performs a second and final string string confusion similarity evaluation. The result of the EPSRP review is made public and is final.

### 4.3 Extended Process Similarity Review Panel Function

The Extended Process Similarity Review Panel (EPSRP) can be called on to perform a second and final confusing similarity validation of the requested IDN ccTLD string if the similarity review deems the string to be invalid and only if so requested by the requester.

The EPSRP shall review the requested strings on the basis of the framework described below with a clear focus on the overarching principle to preserve and ensure the security stability and interoperability of the DNS.

This methodology represents a significantly different approach for the confusing similarity evaluation and is highly likely to be more time consuming and to require additional resources. As such it will only be used when required by the requester after the DNS Stability Panel has completed its assessment.

This evaluation shall be carried out by way of review and comparison of the requested string against the ISO 646-BV two letter (a-z) codes and/or existing TLD strings and/or reserved names that according to the DNS Stability Panel findings are considered to be confusingly similar.

The EPSRP includes at a minimum one highly regarded specialists in neuropsychological or neurophysiology research in character recognition shall use the evaluation results of an appropriate research group and shall take into account all the related documentation from the requester including submitted additional documentation IDN tables available and the findings of the String Similarity Panel.

The report of the EPSRP shall include documentation of the method used its findings and in case of confusing similarity characters a reference to the characters and strings it has observed the similarity and the rationale.

The findings of the EPSRP shall be reported to ICANN staff and will be publicly announced on the ICANN website. This report shall include and document the findings of the EPSRP including the rationale for the final decision and in case of confusing similarity a reference to the strings that are considered confusingly similar and to examples where the panel observed this similarity.

Editor 6/19/13 2:49 PM

Deleted: Staff

Editor 6/19/13 2:49 PM

Deleted: .



### **4.3.1 EPSRP Framework**

---

Scientific evaluation refers to using formal experimental techniques and the latest results from the research of the scientific community concerned with perception of writing and character recognition. In principle it should provide a scientifically founded, detailed and documented basis for conclusions regarding the potential for confusion.

Many areas of science, which focus on the brain, such as psychology and neurophysiology, have focused their attention on trying to understand how the brain processes written communications.

The latest results from this research community confirm that large scale subjective evaluation using a formal framework is the best method for scientifically determining the potential for confusion between characters or strings of characters.

The methodology requires several hundred evaluators, is independent of script and can easily be adapted to take into consideration the impact of fonts and size.

Such evaluations can be carried out effectively and efficiently using web based tools in an open environment.

# Module 5

## *Request Submission Stages for String Evaluation*

This module contains details of the process for requesting an IDN ccTLD string under the Fast Track Process including instructions for completing and submitting required supporting documentation and other necessary materials.

This module also explains how to request assistance concerning the process and the circumstances under which a submitted request can be withdrawn or terminated.

### **5.1 General Fast Track Process Overview**

The IDN ccTLD Fast Track Process involves three distinct stages:

- Stage 1: Preparation
- Stage 2: Request Submission for String Evaluation
- Stage 3: Request Submission for Delegation Evaluation.

These three stages are described briefly in the following subsections 5.1.1 to 5.1.3. The remaining sections in this Module 5 are focused on Stage 2: Request Submission for String Evaluation.

#### **5.1.1 Preparation (Stage 1)**

In the Preparation Stage the requester undertakes preparatory work to enter the Fast Track Process. Primary preparation activities include identification, selection and development of:

- The language(s) and script(s) for the IDN ccTLD string(s)
- Selection of the string(s) representing the name of country or territory for the IDN ccTLD(s) and
- The development of the associated IDN Table(s) and identification of any potential variant characters. The IDN table(s) must be submitted to ICANN as part of the required supporting documentation for the request.

In addition, at this time the requester develops the required documentation of endorsements. Documentation of endorsements must include:

- Documentation of support for the request from the relevant government or publicly authority for the country or territory (if applicable)
  - o See Module 2 for details and a guiding example
- Documentation that the selected language(s) is considered official in the country/territory (if applicable) and in which way it is considered official
  - o See Module 3 for details and a guiding example
- Documentation that demonstrates the requested string(s) is a meaningful representation of the corresponding country/territory (if applicable)
  - o See Module 3 for details and a guiding example

- Documentation that the selected string(s) and IDN ccTLD manager is supported by the local community
  - o The involvement of the relevant stakeholders in the country or territory should be documented in a manner similar to that required for a standard ccTLD delegation request by the requester. The documentation should demonstrate that there has been community dialogue regarding which string is the appropriate representation of the country and that appropriate stakeholders have been involved in the decision making process.
  - o See <http://www.iana.org/domains/root/delegation-guide/> for more guidance for the community support of the IDN ccTLD manager.
  - o A guiding description for community string support is attached to this Module 5 Appendix 2.

The IDN ccTLD manager need not be appointed until the request has reached Stage 3: Request for Delegation Evaluation. Requests can be submitted by either the identified IDN ccTLD manager by the relevant government or public authority or by their designated representative.

To support the requesters in preparing requests ICANN will be launching a support function for guidance and support for preparation or launch of IDN related matters. See this Module 5 section 5.3 for more details.

### ***5.1.2 Request Submission for String Evaluation (Stage 2)***

---

In Stage 2: Request Submission for String Evaluation the requester submits a request for the selected string(s) to be verified by ICANN as eligible to be a representation of the country or territory. The request is reviewed through the defined validation steps including:

- Request Completeness Validation
- Linguistic Validation
- DNS Stability Evaluation
- Public Posting of Validated String(s)

The steps in Stage 2 are described in further detail in section 5.6.

### ***5.1.3 Request Submission for Delegation Evaluation (Stage 3)***

---

After a request has successfully passed Stage 2: Request Submission for String Evaluation it can enter the Stage 3: Request Submission for Delegation Evaluation.

In this phase the standard ICANN IANA process for delegations is followed as already exists for ASCII country-code top-level domains. The ICANN Board approves the delegation.

The process for the Request for Delegation Evaluation is described in detail in Module 6.

Once the delegation process is concluded successfully the string(s) is delegated in the DNS root zone after which the domain is active and the IDN ccTLD manager can commence operations such as accepting registrations within the new IDN ccTLD.

## **5.2 Submission of an IDN ccTLD Fast Track Request**

---

Formal requests for IDN ccTLDs can be submitted to ICANN starting 16 November 2009. The submission system for the string evaluation stage (Stage 2) is a web-based form that identifies the information necessary. The web-based form is available at <http://www.icann.org/en/topics/idn/fast-track/>

Figure 5.1 illustrates an overview of the IDN ccTLD Fast Track Process

By submitting the request the requester must acknowledge that they understand that usability of IDNs may be limited in that some software applications may not be capable of working with IDNs. Further some acceptability and usability issues may occur as the IDNA protocol standard is revised and the IDN protocol for email management is finalized in the IETF. Until standards are implemented broadly adopted by relevant application software writers users may experience different results in different applications and may experience no functionality at all.

By submitting the request the requester agrees to the terms and conditions presented in the online request system. The requester has the additional options to select further arrangements with ICANN. See Module 7 for copies of all such material.

The necessary supporting documentation for the string evaluation must be uploaded in electronic form to the online request system and submitted together with the request to ICANN. In addition supporting documentation must be provided in original form to ICANN in signed hard copy format at the following address:

ICANN  
12025 Waterfront Drive Suite 300  
Los Angeles CA 90094-2536  
USA

Attn: Request for an IDN ccTLD Fast Track

All information provided in a request must be provided in English or with an accompanying official English translation of any non-English information. Any information and supporting documentation not provided will delay processing.

The request submitted online must also be printed and signed. A signed hard-copy must be postal mailed to ICANN at the above address.

Requesters that are unable to utilize the online request system for submitting their request should contact ICANN directly at [idncctldrequest@icann.org](mailto:idncctldrequest@icann.org)

The end date for submission of a Fast Track request will be announced as soon as it is known. It is expected to last through the adoption and implementation of the IDN ccTLD policy development recommendations.

Requests for IDN ccTLDs will be processed manually due to the expected limited number of requests. The expected number of requests is based on the replies ICANN received to a request for information (RFI) from potential participants in the Fast Track Process. A detailed overview of the responses to this outreach activity can be found at:

<http://www.icann.org/en/announcements/announcement-10feb09-en.htm>

### **5.3 ICANN Staff Support and Contact Functions**

---

To support countries and territories in participating in the Fast Track Process an ICANN point of contact and support function is available. The support function described in greater detail in the following is available to prospective requesters in their preparation phase as well as after the requested IDN ccTLD(s) are delegated.

During the entire string evaluation (Figure 5.1) requesters will have no verbal contact with any ICANN staff member any ICANN Board member or any person associated with the evaluation process including any evaluators experts examiners or reviewers retained by ICANN. If such contact is attempted the requester will be redirected to submit their inquiry to the system that is in place for such inquiries (see the description for the web-based request system above). The exception to this case would be when or if a requester is approached by ICANN or its agents for clarification of information in the submitted request. In addition some communication will occur during the standard ICANN function for delegation of the IDN ccTLDs and for providing root management services.

#### **5.3.1 General Contact Details**

---

ICANN IDN Staff will be available to assist prospective IDN ccTLD managers in areas related to IDN preparations development and implementation.

All requests for assistance or any inquiries about the Fast Track process must be submitted to [idnccldrequest@icann.org](mailto:idnccldrequest@icann.org)

Answers to the most common questions about the Fast Track Process are available in an FAQ on the Fast Track website at <http://www.icann.org/en/topics/idn/fast-track/>

#### **5.3.2 Specific IDN Support Details**

---

To support the requesters in their preparations ICANN will make a support function available that provides guidance and information in the development of elements related to requesters' IDN registration policy. This support function will be available in the Preparation Stage and again to an IDN ccTLD manager following delegation of the requested IDN ccTLD(s).

The following elements will be included in the IDN support process:

1. Request for linguistic support to demonstrate the meaningfulness of an desired IDN ccTLD string:
  - 1.1. Upon request ICANN will provide recommendations for experts that can produce such reports.

- 1.2. The recommendations will in some cases be based on advice from the UNGEGN. For non-UN members a separate process will be used for identifying an adequate expert.
2. Review and implementation of IDN Guidelines including support for understanding the details of the following requirements:
  - 2.1. Implementation of IDNA protocol requirements
  - 2.2. Defining script or language and sets thereof
  - 2.3. Development of IDN Table(s) including identifications of variants
  - 2.4. Posting of IDN Table(s) in the IANA repository
  - 2.5. Making all information available online
  - 2.6. Identification of stakeholders that need to be consulted
3. Support and description of various available options for decision-making on implementation issues such as:
  - 3.1. How to determine which characters to support (protocol validity user survey variants)
  - 3.2. Development of general registration policy (such as first-come-first-serve grandfathering or other preregistration rights or intellectual property rights)
  - 3.3. Development of variant registration policy (such as bulk vs. block registrations)
  - 3.4. Definition of necessary tools and support functions related to registrar communication support needs and implementation topics in general.
  - 3.5. Support for development of more technical tools needed such as WHOIS capabilities IDNA conversions and more.

In developing IDN Tables and associated registrations policies requesters are encouraged to work with other language communities that are using the same (or similarly looking) script(s) as the basis for the languages they plan to support.

ICANN will provide support and general assistance in these matters. ICANN will not provide legal or business advice to countries or territories or any potential or existing registry managers.

#### ***5.4 Termination of Submitted Requests***

---

Several of the steps in the Request Submission for String Evaluation (Stage 2) allow for a requester to withdraw a request. It is also possible that ICANN will terminate a request if the request contains certain errors.

Errors resulting in possible termination include the following:

- The requested string is already a string delegated in the DNS or approved for delegation to another party.
- The country or territory of the request does not correspond to a listing in the ISO3166-1 list or the European Union.

- The requested string consists of one or more characters from the Latin script.
- The language represented does not fulfill the language criteria for the corresponding country or territory.

If such errors are discovered the requester will be contacted by ICANN and provided an opportunity to amend its request. Alternatively the requester may decide to withdraw the request.

Other issues arising from a submitted request may delay the determination of whether the requested string should be delegated. Such delaying factors could include: (1) the requested string is already applied for in the Fast Track Process (2) the requested string is already applied for in the gTLD process (3) the request does not contain support from the corresponding country or territory and (4) the requested string is not included in the UNGEGN manual and it is not otherwise substantiated that the string is a meaningful representation of the corresponding country or territory name. In all such cases the requester will be consulted for clarifications before any decision on the request is made.

### 5.5 String Confusion and Contention

String confusion exists where a string so nearly resembles another visually that it is likely to deceive or cause confusion. For the likelihood of confusion to exist it must be probable not merely possible that confusion will arise in the mind of the average reasonable Internet user. Mere association in the sense that the string brings another string to mind is insufficient to find a likelihood of confusion.

String confusion issues can involve two or more strings that are identical or are so confusingly similar that they cannot coexist in the DNS such as:

- Requested IDN ccTLD strings against existing TLDs and reserved names
- Requested IDN ccTLD strings against other requested IDN ccTLD strings and
- Requested IDN ccTLD strings against applied-for gTLD strings.

Contention situations between Fast Track requests and new gTLD applications are considered unlikely to occur. Assessments of whether strings are considered in conflict with existing or applied-for new gTLD strings are made during the DNS Stability Evaluation for Fast Track requests and in the Initial Evaluation step for new gTLD applications. The following supplemental rules provide the thresholds for solving any identified contention issues:

- A gTLD application that is approved by the ICANN Board will be considered an existing TLD in inter-process contention unless it is withdrawn. Therefore any other later application for the same string will be denied.
- A validated request for an IDN ccTLD will be considered an existing TLD in inter-process contention unless it is withdrawn. Therefore any other later application for the same string will be denied.

For the purpose of the above contention rules an IDN ccTLD string request is regarded as validated once it is confirmed that the string is a meaningful representation of the country or territory and that the string has passed the DNS Stability Evaluation as described in Module 4.

Editor 6/19/13 2:49 PM

Deleted: .

Editor 6/19/13 2:49 PM

Deleted: in

Editor 6/19/13 2:49 PM

Deleted: String

Editor 6/19/13 2:49 PM

Deleted: Panel evaluation

## 5.6 Processing of a Fast Track Request

---

Requests for IDN ccTLD(s) submitted to ICANN will be subjected to a series of manual evaluation reviews by ICANN staff and by outside appointed experts where required. Figure 5.1 outlines the overall process while the detailed processes are described in the following subsections and associated figures.

### 5.6.1 Request Completeness Validation

---

The first activity after ICANN receives a request for an IDN ccTLD(s) is a check that the request is complete. This is illustrated in Figure 5.2.

ICANN will verify that all required fields have been entered and that the information provided is sufficient to initiate the string evaluation.

ICANN will verify that:

- The requested string (A-label) does not exist in the DNS is not approved for delegation to another party and it (U-label) is not identical to an entry in the Reserved Names list.
- The requested string (U-label) does not contain Latin characters.
- The requested string (U-label) is at least 2 characters long.
- The following required elements are in agreement: the requested string(s) (U-label) the identified ISO 3166-1 corresponding code the identified UNGEGN Manual entry (if applicable) and the language(s) or script(s) listed in the IDN Table.
- The following required elements are in agreement: the requested string (U-label) the identified script(s) and language(s).
- The following required elements are in agreement: the requested A-label U-label and corresponding Unicode code points.
- All contact details provided are accurate and usable
- If the string request is not coming from the government formal documentation from the relevant government or administration supporting the requester as sponsor is included. (ICANN will verify that the received documentation of support is from an authoritative source.)
  - o ICANN Staff may seek assistance from the GAC in verifying that the documentation is from an authoritative source.

This check identifies requests as complete or incomplete. ICANN staff will inform the requester of any missing elements or errors in the request and the requester will be able to either provide additional information at this time or withdraw the request (and potentially resubmit at a later time).

If no errors are encountered ICANN staff will notify the requester that the Request Completeness Validation is passed successfully and that the Linguistic Process Validation has been initiated.



## 5.6.2 Linguistic Validation

---

The Linguistic Validation Sub-Process is graphically described in Figure 5.3.

In this step ICANN staff is verifying that the following are satisfactory:

- That the selected language(s) and script(s) are considered official in the country/territory of the request.
  - o If the language is listed for the relevant country or territory as an ISO 639 language in Part Three of the Technical Reference Manual for the standardization of Geographical Names United Nations Group of Experts on Geographical Names (the UNGEGN Manual <http://unstats.un.org/unsd/geoinfo/UNGEGN/publications.html>) or
  - o If the language is listed as an administrative language for the relevant country or territory in the ISO 3166-1 standard under column 9 or 10 or
  - o If the relevant public authority in the country or territory has confirmed that the language is (i) used in official communications of the relevant public authority and (ii) serves as a language of administration.
- That the received documentation of community support for the string(s) is satisfactory.
  - o This should be demonstrated in a similar manner as required for delegation requests see Module 5 Appendix 2 for guiding information.
- That the string(s) requested is a meaningful representation of the corresponding country/territory name by verifying that either:
  - o the string is matching an entry (/entries) in the UNGEGN Manual or
  - o the received expert documentation states that the string(s) is a meaningful representation of the country/territory name.

For the purpose of the Fast Track Process the requested string is a meaningful representation of the corresponding country or territory name if it is listed as the long or short form name of that country or territory in Part Three of the Technical Reference Manual for the standardization of Geographical Names United Nations Group of Experts on Geographical Names (the UNGEGN Manual <http://unstats.un.org/unsd/geoinfo/UNGEGN/publications.html>) in an official language of the country or territory.

If the requested string is not listed for the country or territory in the UNGEGN Manual the requester must provide documentation which includes a report from an internationally recognized expert(s) in a relevant field of expertise.

See Module 3 for more details and guiding examples.

If no errors are encountered ICANN staff will notify the requester that the Linguistic Process Validation is passed successfully and that the DNS Stability Evaluation has been initiated.

### 5.6.3 DNS Stability Evaluation

The DNS Stability Evaluation Sub-Processes are graphically described in Figure 5.4 5.5 and 5.6.

The request and associated material will be provided to the DNS Stability Panel (see Module 4 for details) and the string evaluation will begin. This evaluation consists of two main components:

- i. a detailed technical check in which compliance with all the technical string requirements referenced in Module 3 is verified and
- ii. an evaluation of confusability with any Reserved Name existing TLDs (both ccTLDs and gTLDs) or potential future TLDs.

If the DNS Stability Panel finds that additional linguistic expertise is necessary to satisfy the latter component of the evaluation such can be requested through ICANN. ICANN will in return request assistance specific information or a full confusability review. The specific expertise needed will partly depend on the actual string in question.

If any issues with the selected string are discovered in this review the DNS Stability Panel can request clarification from the requester through ICANN.

The DNS Stability Panel will usually conduct its review within 30 days unless it informs ICANN staff otherwise and delivers its report to ICANN staff who communicates the findings to the requester.

In the event that the DNS Stability Panel determines a requested IDN ccTLD string is confusingly similar to an existing two-letter ASCII ccTLD corresponding to the same country or territory as the requesting country or territory entity the DNS Stability Panel shall document this in its report to ICANN.

If at the time of the request or within two months after receiving the notification of the findings of the DNS Stability Panel the requester and if considered necessary by ICANN the relevant public authority provide(s) a clarification that documents and demonstrates to ICANN that:

1. The intended manager for the requested IDN ccTLD and the manager for the existing two-letter ASCII ccTLD are one and the same entity and
2. The intended manager shall request the delegation for the IDN ccTLD string if validated and
3. The IDN ccTLD and ccTLD shall remain to be managed by one and the same entity and
4. The intended manager shall agree to specific and pre-arranged conditions with the goal to mitigate the risk of user confusion as of the moment the IDN ccTLD becomes operational

then the requested string is deemed to have passed the DNS Stability Panel evaluation.

If clarifications are insufficient or cannot be provided the Termination Process will be initiated. See section 5.4.

Editor 6/19/13 2:49 PM

**Deleted:** Process is

Editor 6/19/13 2:49 PM

**Deleted:** Technical

Editor 6/19/13 2:49 PM

**Deleted:** Names

Editor 6/19/13 2:49 PM

**Deleted:** but could for example imply a full review conducted by the String Similarity Panel. This is a panel assessing string pairs for confusing similarity following the rules set forth in section 5.5 and as established for the new gTLD Program (<http://www.icann.org/en/topics/new-gtld-program.htm>).

Editor 6/19/13 2:49 PM

**Deleted:** requestor

In the event that the DNS Stability Panel determines a requested IDN ccTLD string is confusingly similar to any other than existing two-letter ASCII ccTLD string corresponding to the same country or territory as the requesting country or territory entity and the requester has been informed as such by ICANN the requester may call for the second and final Extended Process Similarity Review and provide additional documentation and clarification referring to aspects in the report of the DNS Stability Panel. The requester should notify ICANN within three (3) calendar months after the date of notification by ICANN that a review by the EPSRP is requested and include the additional documentation if any. After receiving the notification from the requester ICANN shall call on the EPSRP.

Editor 6/19/13 2:49 PM  
Deleted: If

The EPSRP conducts its evaluation of the string based on the methodology and criteria developed for it as described in Module 4.3 and taking into account but not limited to all the related documentation from the requester including submitted additional documentation IDN tables available and the findings of the DNS Stability Panel. The EPSRP may seek clarification from the requester through ICANN staff if necessary.

The findings of the EPSRP shall be reported to ICANN and will be publicly announced on the ICANN website. This report shall include and document the findings of the EPSRP including the rationale for the final decision and in case of resulting risk confusion a reference to the strings that are considered confusingly similar and examples where the panel observed this similarity.

If the requester has not notified ICANN within three (3) calendar months after the date of notification by ICANN of DNS Stability Panel findings the Termination Process will be initiated. See section 5.4.

If according to the EPSRP the requested string should not be considered confusingly similar the requested IDN ccTLD string is valid.

If the DNS Stability Evaluation reveals no issues the requester is notified that the DNS Stability Evaluation has successfully been completed and is valid and that the requested string(s) will be queued for public posting.

Editor 6/19/13 2:49 PM  
Deleted: technical

Editor 6/19/13 2:49 PM  
Deleted: String

Editor 6/19/13 2:49 PM  
Deleted: is

#### Transitional Arrangement

If an IDN ccTLD string request submitted under the Fast Track Process is still in process or has been terminated due to non-validation of the string per confusingly similarity criteria the requester has the option to request a second and final validation review by the Extended Process Similarity Review Panel. This option is available to the requester within three (3) calendar months of the date of when the EPSRP is appointed. Requesters who fall in this category will be notified by ICANN staff of their eligibility for this process when the panel has been seated.

#### 5.6.4 Public Posting of Validated String(s)

Following a successful outcome of the String Confirmation Process the requested IDN ccTLD string(s) will be posted publicly.

Figure 5.7 illustrates an overview of the Public Posting Sub-Process

Editor 6/19/13 2:49 PM  
Deleted: 5

The ICANN Fast Track website <http://www.icann.org/en/topics/idn/fast-track/> will contain an area dedicated to presenting strings that reach this step in the Fast Track Process. RSS feeds of changes to this area will be made available.

### ***5.6.5 IANA Delegation Readiness***

---

Following the public posting of the requested string all Stage 2 process requirements are considered successfully completed. The requester will be notified that the standard IANA delegation process can begin and what further actions are necessary. The IANA delegation process is described in Module 6.

# Appendix 1 to Module 5

Figure 5.1: General Overview of the IDN ccTLD Fast Track Process

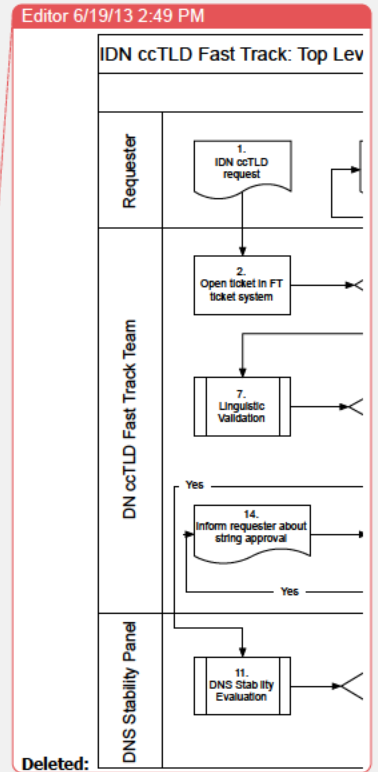
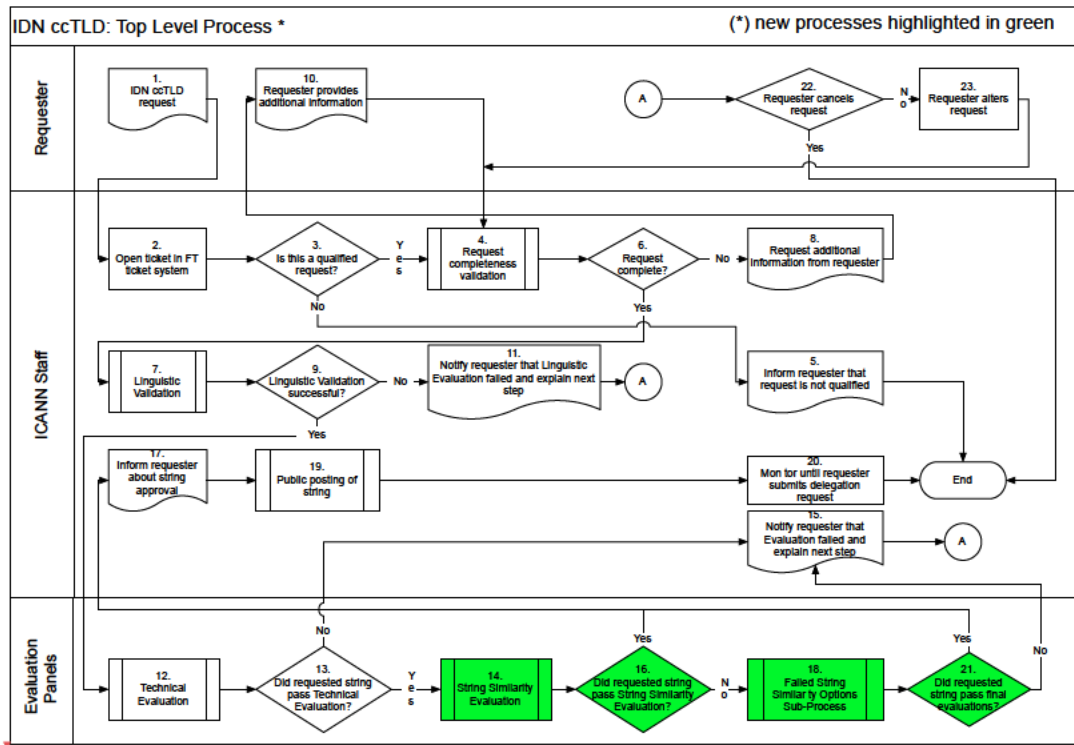

Figure 5.2: Overview of the Request Completeness Validation Sub-Process

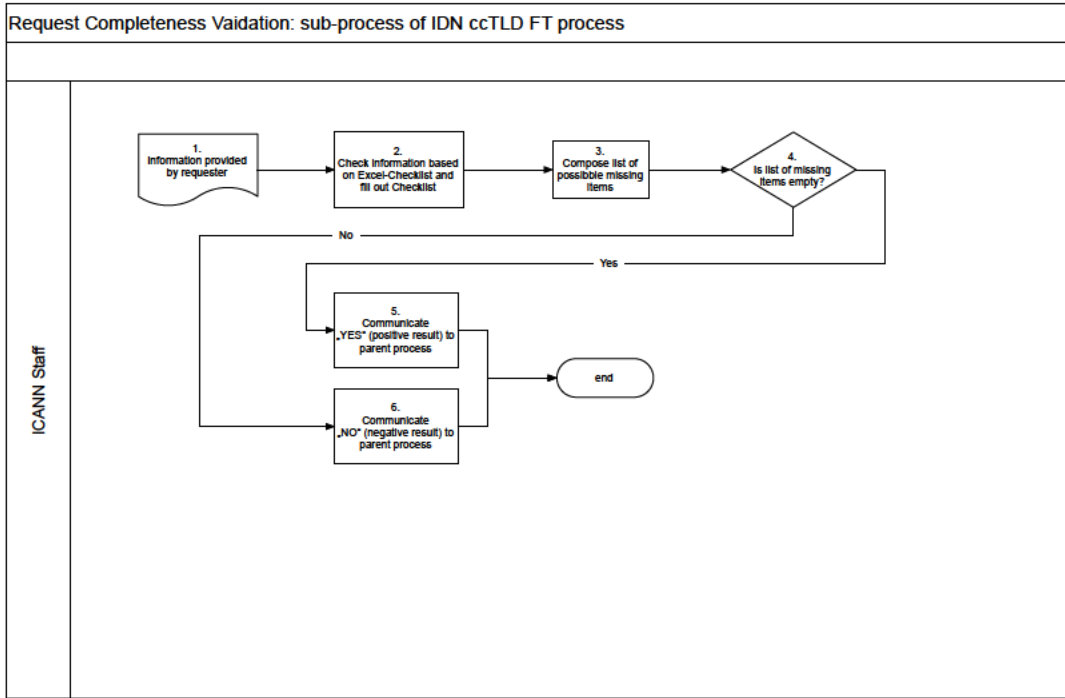

Figure 5.3: Overview of Linguistic Validation Sub-Process

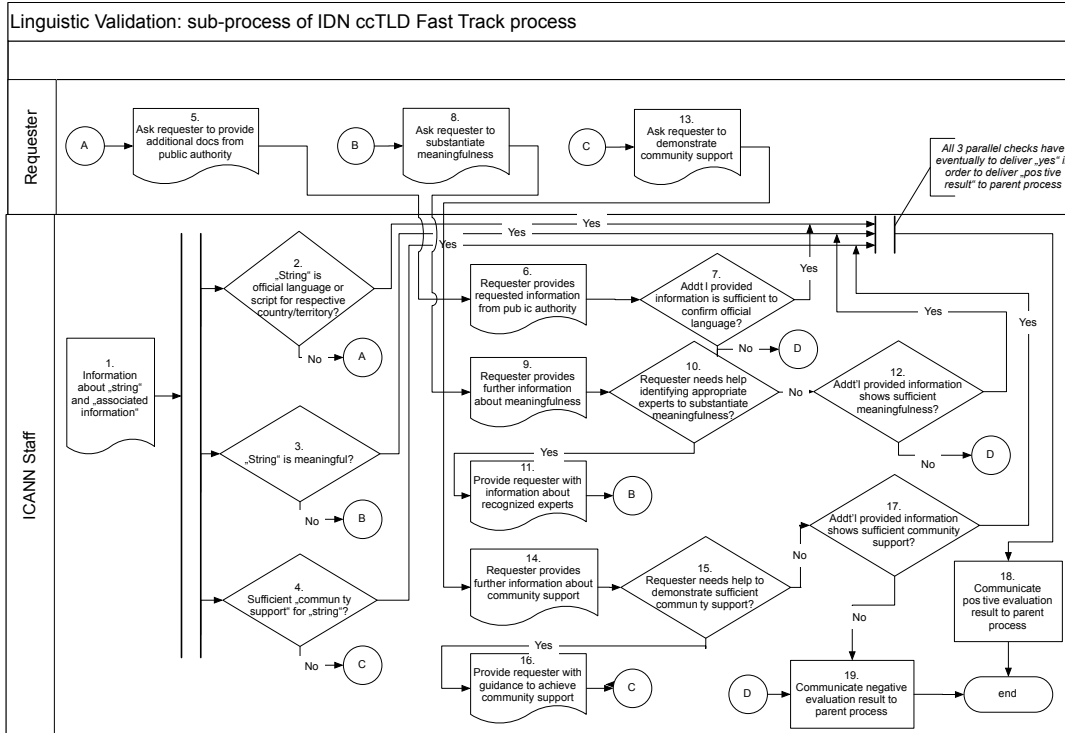
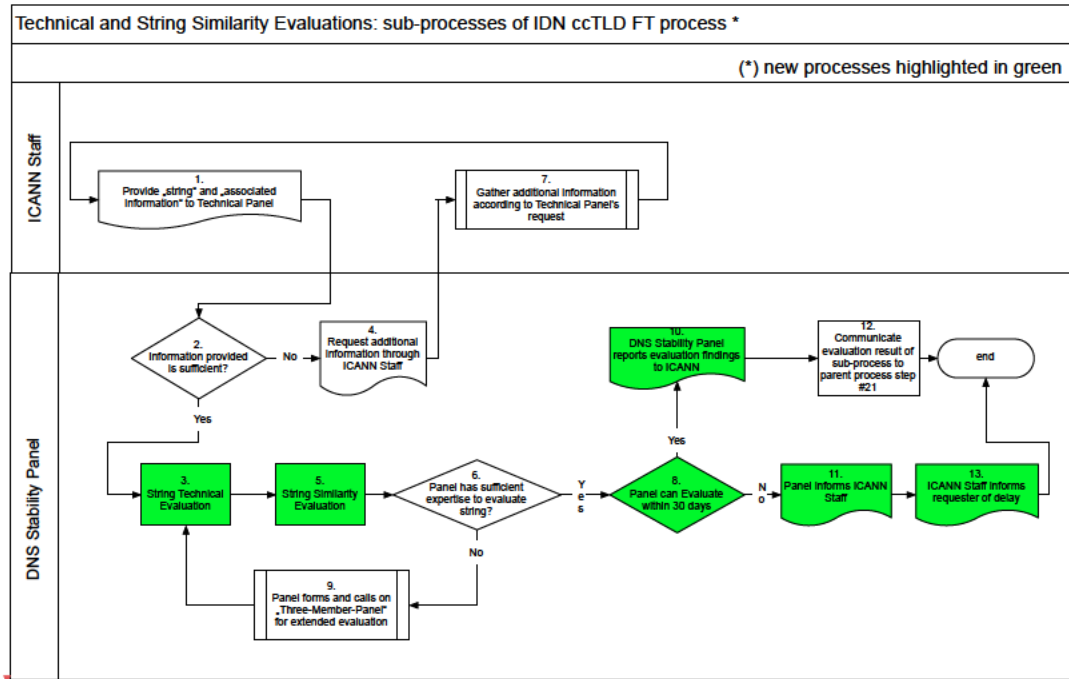

Figure 5.4: Overview of the Technical and String Similarity Evaluations Sub-Process



Editor 6/19/13 2:49 PM

Deleted: DNS Stability Evaluation

Editor 6/19/13 2:49 PM

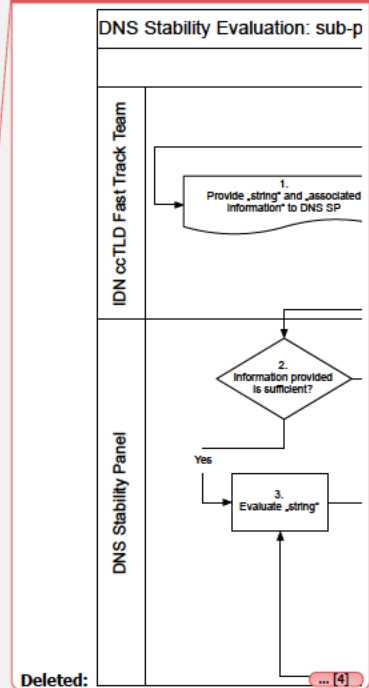

Deleted: ... [4]



Figure 5.5: Overview of the Failed String Similarity Options Sub-Process

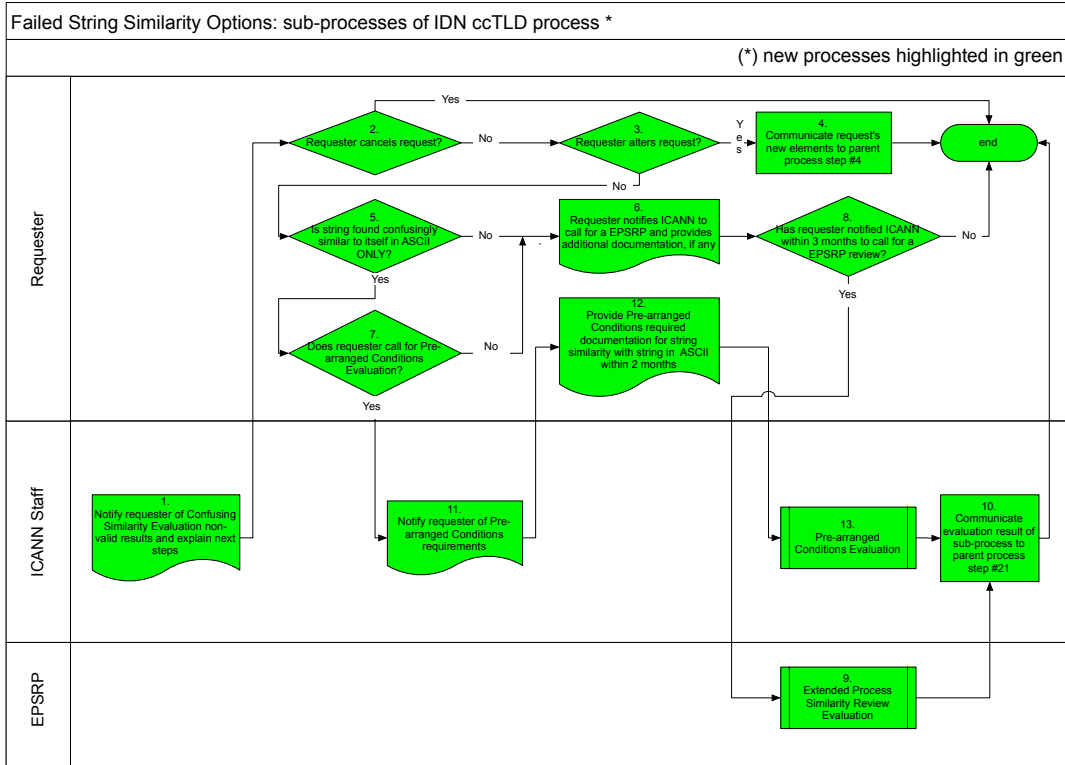

Figure 5.6: Overview of the Extended Process Similarity Review Evaluation Sub-Process

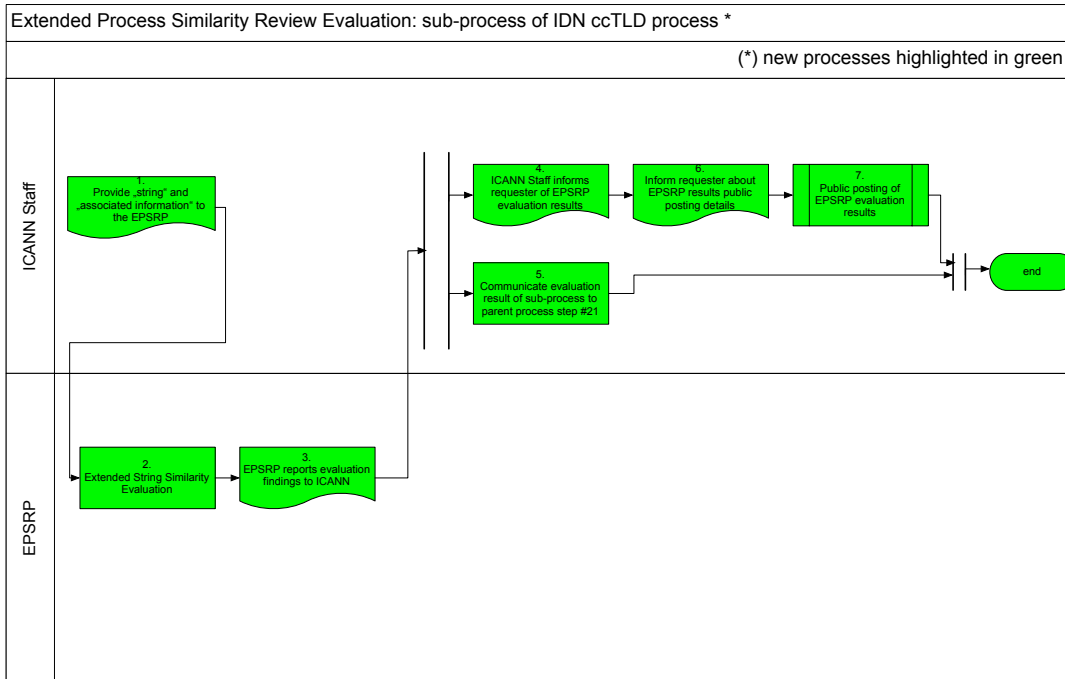
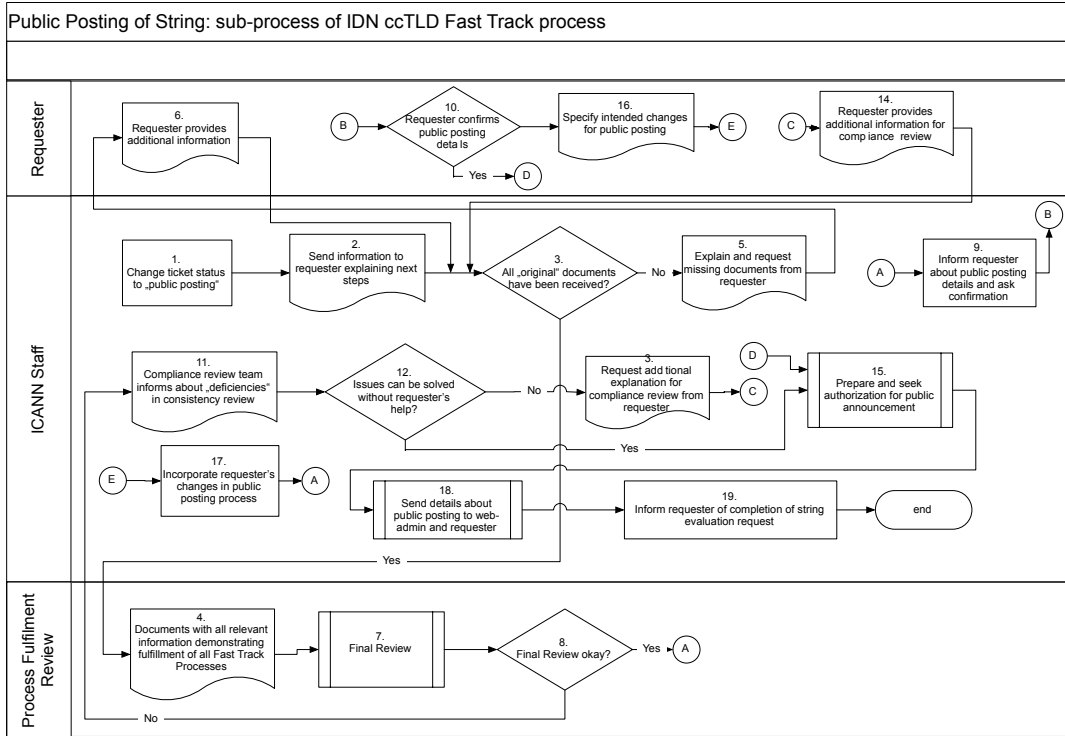

Figure 5.7: Overview of the Public Posting Sub-Process



## Appendix 2 to Module 5

---

### *Sample: evaluation criteria for string selection community support*

---

#### *Sample Requirement*

---

The selection of the string to represent a country or territory needs to be in the interests of the Internet user community of the country or territory. There should be dialogue in the country or territory about what string(s) should be selected to best support the local Internet community.

Requesters should explain how consensus was reached (among relevant stakeholders in the local Internet community) on the string(s) that is requested including the consultative processes that were undertaken.

Any opposition to the proposal should also be documented including alternatives that were considered as well as an explanation why on balance it was decided to proceed with the request.

As part of this statements from significant entities — such as user groups Internet organizations ISPs trade groups etc. — can be tendered. The statements should explain their views on the proposal ideally discussing what different alternatives they have considered.

#### *Evaluation aspects*

---

Consultations performed:

It is an important aspect of a request that a dialogue has been conducted within the local Internet community on how the proposed string(s) was selected. It is not appropriate that a top-down methodology should be imposed on the Internet community without opportunity for them to discuss options and gain consensus on an appropriate approach.

Appropriate level of participation:

It is expected that participation in developing a proposal comes from a number of actors that represent the local Internet community. The objective is to ensure key parties were involved or at least had a fair opportunity to participate in deliberations concerning the approach being presented.

Significant objection identified and discussed:

It is not expected there would be complete support for any proposal — there will very likely be opposing views. It is expected however that the requester explains the opposing views analyses and distills them and explains why the requested string(s) is considered the best approach despite those views.

Specific viewpoints:

Considered contributions for key Internet community bodies such as trade organizations key corporations etc. can be evaluated. They should not be "form letters" that have simply been signed but considered honest opinions from the perspective of the organization regarding the requested string(s).

# Module 6

## Delegation Process

ICANN maintains a process for delegating top-level domains in its execution of its IANA functions. A guide to the delegation procedure for existing country-code top-level domains is described at <http://www.iana.org/domains/root/delegation-guide/>. This process remains largely applicable to IDN ccTLDs. The online document will be updated to reflect updated operational practices for IDN ccTLDs.

Requesters that have successfully completed the String Evaluation Process will receive a notification from ICANN that the selected string has been approved for use by that country or territory and that they are welcome to apply for the delegation process (Stage 3). While the process described in Module 5 is concerned with assessing the string the delegation process involves assessing whether the proposed sponsoring organization is a qualified trustee for the local Internet community.

As the requirements of the two processes are separate the requester must submit the qualifying documentation for delegation separately. If some documentation is the same as for the string evaluation process it must be resubmitted at this time.

### 6.1 IANA Function

ICANN manages the IANA functions under a contract with the United States Department of Commerce. The IANA function process for delegating an IDN ccTLD will remain consistent with the process for existing TLDs directly derived from the ISO 3166-1 standard. The process will be augmented only to include the requirements in Module 5.

In this process ICANN staff will receive a request to delegate an IDN ccTLD that is composed of a formal template explaining the delegation request together with supporting documentation. This supporting documentation must describe how the principles in RFC1591 ICP-1 and the GAC principles are supported. Some of these principals are:

#### 6.1.1 Operational and Technical Skills

- 1.1 The prospective manager has the requisite skills to operate the TLD appropriately.
- 1.2 There must be reliable full-time IP connectivity to the name servers and electronic mail connectivity to the managers.
- 1.3 The manager must perform its duties in assigning domains and operating name servers with technical competence.

#### 6.1.2 Manager in Country

- 1.4 The prospective manager supervises and operates the domain name from within the country or territory represented by the TLD.
- 1.5 The prospective administrative contact must reside in the country represented by the TLD.

### **6.1.3 Equitable Treatment**

---

- 1.6 The Registry manager shall operate the IDN ccTLD in a manner that allows the TLD community to discuss and participate in the development and modification of policies and practices for the TLD.

### **6.1.4 Community/Governmental Support**

---

- 1.7 The prospective manager has the requisite authority to operate the TLD appropriately with the desire of the government taken very seriously.
- 1.8 Significantly interested parties in the domain should agree that the prospective manager is the appropriate party to receive the delegation.

In addition to material that demonstrates the requester suitability under these RFC 1591 criteria requesters must provide the additional specific material relating to the evaluation described in the Module 5. This requirement will be satisfied by the Delegation Readiness report that describes the IDN-specific factors.

ICANN will perform due diligence on the documentation provided in accordance with ICANN's IANA review process described in RFC 1591. If the request does not adequately cover all areas they will confer with the requester who may provide further information. When ICANN deems the IANA due diligence evaluation complete it will forward the request and its assessment for ICANN Board review.

## **6.2 ICANN Board Review Process**

---

All delegations and re-delegations of ccTLDs require ICANN Board approval to proceed. This approval is expected to remain constant with the introduction of IDN ccTLDs.

At the conclusion of ICANN's IANA function evaluation the ICANN Board will assess the delegation request.

The ICANN Board will evaluate whether requests are consistent with governing policies and with ICANN's core values set out in its bylaws to "ensure the stable and secure operation of the Internet's unique identifier systems."

## **6.3 US Government Authorization**

---

After approval of a request ICANN will execute its regular IANA function root zone change management process.

This change involves retesting the technical configuration of the delegation data supplied by the requester and ensuring that name servers function correctly. Once satisfied the request will be transmitted to the US Department of Commerce for authorization. Following this authorization it will be implemented in the DNS root zone.

# Module 7

## *Relationship between IDN ccTLD Manager and ICANN*

This module contains a description of the required and optional relations between an IDN ccTLD manager and ICANN.

The topics of mandatory or voluntary relationship between ICANN and the IDN ccTLD managers have been discussed in several meetings and online fora.

The community has expressed broadly ranging opinions on this matter. In an attempt to converge community opinions various proposed solutions have been posted for public discussions and comments.

In keeping with ICANN's stability and security mission the IDN ccTLD requester agrees to a basic set of terms and conditions as part of submitting a request for an IDN ccTLD. If the requester is not the IDN ccTLD manager the requester will be making such agreement on behalf of the IDN ccTLD manager.

In addition one of the following three relationship options can be elected on a voluntary basis:

Option 1: DoR. Documentation of Responsibility to be executed by both parties.

Option 2: EoL. Exchange of Letters. A pair of unilateral written statements as already established with several ccTLDs.

Option 3: An IDN ccTLD Registry Agreement with ICANN governing the operation of the delegated string.

Proposed details for (i) Terms and Conditions (ii) DoR and (iii) EOL are attached in Appendix 1 to this Module 7. The template for the IDN ccTLD Registry Agreement will be provided requestors when available (if requested through the Online Request System). They generally imply commitments to:

- o operate in a stable secure manner
- o adhere to IDNA protocol other pertinent RFC's and IDN Guidelines
- o engage in cooperation to resolve disputes and

not implement DNS redirection and synthesized DNS responses

# *Appendix 1 to Module 7*

---

Appendix 1:

Required Terms and Conditions for the IDN ccTLD Fast Track Submission

Documentation of Responsibility

Proposed ICANN to IDN ccTLD Exchange of Letter

Proposed IDN ccTLD to ICANN Exchange of Letter



## *Terms and Conditions of Submission Fast Track requests*

---

### **General Information on Submission of Request for String Evaluation**

By signing and submitting this request we (the "Requestor") acknowledge and understand that:

The Internet Corporation for Assigned Names and Numbers (ICANN) as the steward of the global interoperable Internet is accepting submissions for requests for string evaluation of IDN ccTLD strings.

Usability Warning: The usability of IDNs may be limited as not all application software is capable of working with IDNs. It is up to each application developer to decide whether or not they wish to support IDNs. This can include for example browsers email clients and sites where you sign up for a service or purchase a product and in that process need to enter an email address. Such usability problems currently exist today with the ASCII TLDs in some situations.

Further acceptability and usability issues may occur as the IDNA protocol standard is revised and as the IDN protocol for email management is finalized in the Internet Engineering Task Force (IETF). The result of the IDNA protocol revision will be that some characters previously not permitted within IDNs will become valid. ICANN will accept requests for strings with these newly valid characters but until the new revised standard is implemented and broadly adopted by relevant application developers users may experience problems with using the IDN. This may have different results in different applications and in some instances a user may experience no functionality at all. It would be appropriate for all IDN TLD managers to provide their users with information about the limitations of use of IDNs and at the same time promote the use of IDNs to achieve global IDN implementation across applications. ICANN supports such efforts but is not able to enforce or require them.

String Evaluation Stage: The submission of this request initiates the "Request Submission for String Evaluation" stage as set forth in the Implementation Plan for the IDN ccTLD Process.

Payment of the pre-arranged recommended fee (USD \$26 000) for the processing of a request in the String Evaluation Stage is expected. ICANN will submit a notice of this amount to you. The processing fee can be paid in local currency. If you are unable to pay this fee you can contact ICANN stating the reason for the inability to pay the fee.

Payment of a pre-arranged recommended annual contribution to ICANN's cost of operations in the amount 1-3% in local currency of the revenue from the registrations of domain names within the selected TLD is expected. ICANN will submit a notice of the structure of this amount to you on an annual basis. The ccTLD manager will be responsible for detailing the contribution. ICANN will not be requesting revenue-related information.

String Delegation Stage: The "Request Submission for String Evaluation" stage must be successfully completed before a separate request for the delegation of the IDN ccTLD can be submitted. A request for the delegation of the IDN ccTLD will be processed in accordance with ICANN's standard IANA process for the delegation for ASCII country-code top-level domains. The request may be withdrawn by the organization submitting the request (the "Requestor") or terminated by ICANN as set forth at Section 5.4 of the Implementation Plan for the IDN ccTLD Process.

ICANN's commitment to accountability and transparency will be followed. This means that certain information relating to the "Request Submission for String Evaluation" stage will be publicly available either on ICANN's website or subject to disclosure under ICANN's Documentary Information Disclosure Policy. See more details at: <http://www.icann.org/en/transparency/didp-en.htm>.

By signing and submitting this request the Requestor commits to TLD operations that will secure and enhance the stability and interoperability of the Internet's Domain Name System (DNS) for the benefit of the local and global Internet community and to working in good faith together with ICANN towards a stable and secure Internet DNS. The Requestor understands that ICANN reserves the right to take actions necessary to protect the security stability and interoperability of the global DNS.

ICANN expects that IDN ccTLDs will be established and operated in the manner described below:

- a. *The IDN ccTLD manager shall establish, operate and maintain the authoritative name servers for the requested string in a stable and secure manner, adequate to resolve names within the requested string by users throughout the Internet and in compliance with Relevant Applicable Standards subject to and within the limits of relevant national law and national public policy. Relevant Applicable Standards are standards-track or best current practice RFCs sponsored by the Internet Engineering Task Force;*
- b. *IDN domain names are to be registered in accordance with a publicly available registration policy that shall comply on an ongoing basis with relevant applicable standards to IDNs, such as the IDNA Protocol, and with the IDN guidelines as updated and published from time to time on the ICANN website, all subject to and within the limits of relevant applicable national law and public policy. This includes, but is not limited to, adherence to RFCs 3490, 3491, 3492, 3454 and their successors;*
- c. *The IDN ccTLD manager should not use DNS redirection and synthesized DNS responses within any level of the registry; and*
- d. *The Requestor agrees that the IDN ccTLD manager will cooperatively engage with ICANN in the event of an activity or lack of activity that generates a serious concern regarding the stability, security or interoperability of the Internet's Domain Name System (DNS) from a global perspective. Briefly, the cooperative engagement process involves the designation of an official representative from ICANN and the IDN ccTLD manager, who shall meet with each other telephonically and/or in person to address the concerns in good faith and attempt to reach a resolution.*

If the Requestor seeks to enter into ~~Documentation of Responsibilities~~ an Exchange of Letters or a general TLD Agreement with ICANN after delegation please indicate below. For reference templates are available at <http://www.icann.org/en/topics/idn/fast-track>

Editor 6/19/13 2:49 PM  
Deleted: α

Check one of the following:

[Checkbox]: Please send a copy of the prearranged and recommended template for the Exchange of Letters.

[Checkbox]: Please send a copy of the prearranged and recommended Documentation of Responsibilities.

[Checkbox]: Please send a copy of a prearranged and recommended general TLD Agreement.

Requestor warrants that the statements and representations contained in the request (including any documents submitted and oral statements made in connection with the request) are true and accurate and complete in all material respects and that ICANN may rely on those statements and representations fully in evaluating this application.

Requestor acknowledges that any material misstatement or misrepresentation (or omission of material information) will reflect negatively on this request and may cause ICANN to terminate the request.

By submitting this request I represent that I am authorized to act as a representative of Requestor and to enter into the commitments undertaken in this request.

[Name]

[Title]

[Organization]

[Signature]

This Documentation of Responsibilities ('DoR') is between [IDN ccTLD Sponsoring Organization, or "IDN ccTLD SO" ] an organization incorporated under the laws of the [country] in [location] hereinafter referred to as 'IDN ccTLD' and THE INTERNET CORPORATION FOR ASSIGNED NAMES AND NUMBERS hereinafter referred to as 'ICANN' jointly to be referred to as: 'parties' and individually to be referred to as: 'party'.

### A. Background

1. The parties want to demonstrate their commitment to maintain and enhance the stability security and interoperability of the Internet's Domain Name System (DNS) from a global perspective and for the benefit of the local and global Internet community in an evolutionary manner on the basis of a peer relationship.
2. The [.] Top Level Domain has been selected in [name of territory] in [year] and endorsed amongst others by the relevant public authority as a meaningful representation of the name of the territory.
3. The request for delegation of the [.] Top Level Domain was submitted by [IDN ccTLD SO] in [year] and [IDN ccTLD SO] is [legal status in country] and executes its operation in [country]. [IDN ccTLD SO] functions regarding the stability and interoperability of the DNS are to:
  - a. Maintain name servers for the [.] domain
  - b. Generate updates to [.] zone data when changes occur and propagate those changes to all public authoritative name servers for the [.] domain and
  - c. Ensure continued and stable domain name system interoperability with the global Internet.
4. ICANN is responsible for providing technical-coordination functions for the management of the system of unique identifiers of the global Internet including the DNS. Among ICANN's responsibilities is to oversee operation of the Internet's Authoritative Root Server System. As part of ICANN's responsibilities it:
  - a. Enters and maintains data in the Authoritative Root database and triggers updates of the root zone file.
  - b. Coordinates the allocation and assignment of the three sets of unique identifiers for the Internet which are:
    - 1) domain names (forming a system referred to as "DNS")
    - 2) Internet protocol ("IP") addresses and autonomous system ("AS") numbers and
    - 3) Protocol port and parameter numbers.
  - c. Coordinates the operation and evolution of the DNS root name server system.
  - d. Coordinates policy development reasonably and appropriately related to these technical functions.

### B. Mutual Recognition

1. **Recognition of [IDN ccTLD].** ICANN recognizes [IDN ccTLD SO] as the manager and sponsoring organization of the [.] IDN ccTLD and the entity responsible for maintaining the [.] IDN ccTLD as a stable and interoperable part of the global domain naming system for the Internet in a manner that is consistent with [country] national law public policy and naming policy.
2. **Recognition of ICANN.** [IDN ccTLD SO] acknowledges that ICANN is the entity responsible for maintaining and keeping the root of the Internet DNS stable and globally interoperable in a manner that is consistent with ICANN's Mission and Core Values as reflected in its bylaws.

## C. Commitments

### 1. Commitments of ICANN. ICANN shall use its best endeavours to:

a. **Authoritative-Root Database:** maintain a stable secure and authoritative publicly available database of relevant information about [.] the Delegated IDN country code Top Level Domain in accordance with ICANN publicly available policies and procedures. The Authoritative Root Database shall contain information for the public authoritative name servers for [.] contact information for [IDN ccTLD SO] the designated administrative contact(s) and the designated technical contact(s) as notified to ICANN

b. **Update of Name Server Information:** implement on notification by the [IDN ccTLD SO] a change to the domain name or IP address(es) of the name servers for [.] as recorded in the Authoritative-Root Data for [.] in the Authoritative-Root Database according to ICANN's publicly available policies and procedures. The initial format and technical requirements for such a change are set out in ICANN's publicly available policies and procedures

c. **Publication of Root-zone Whois Information:** publish data maintained in the Authoritative Root Database about [.] which shall include at least the names of [IDN ccTLD SO] as the Sponsoring Organization the administrative contact(s) the technical contact(s) and the domain names and IP addresses of the authoritative name servers for the domain

d. **Operation of Authoritative Root Server System:** coordinate the Authoritative Root Server System so that it is operated and maintained in a stable and secure manner and cause the Authoritative Root Server System to publish DNS resource records delegating the [.] IDN ccTLD to the name servers recorded in the Authoritative Root Database and to inform the named administrative contact(s) and technical contact(s) of the published changes to the name servers for [.]

e. **Maintenance of Authoritative Records and Audit Trail:** maintain authoritative records and an audit trail regarding changes to [.] delegations and records related to those delegations and shall inform [IDN ccTLD SO] of the status of a requested change related to [.] in accordance with the policies procedures and format as made publicly available by ICANN and

f. **Notification of Contact Changes:** notify [IDN ccTLD SO] of any changes to ICANN's contact information no later than seven days after the change becomes effective.

### 2. Commitments of [IDN ccTLD SO]. [IDN ccTLD SO] shall use its best endeavours to:

a. **Provision of zone data for [.]:** generate regular updates of the [.] zone data in compliance with relevant standards as set out in paragraph c) and subject to and within the limits of relevant national law and national public policy.

b. **Provision of Name Service for [.]:** operate and maintain the authoritative name servers for [.] in a stable and secure manner adequate to resolve names within the [.] domain by users throughout the Internet and in compliance with Relevant Applicable Standards subject to and within the limits of relevant national law and national public policy. Relevant Applicable Standards are standards-track or best current practice RFCs sponsored by the Internet Engineering Task Force.

c. **Adherence to relevant IDN standards and guidelines:** register IDN domain names in accordance with its publicly available registration policy which shall comply on an ongoing basis with Relevant Applicable Standards to IDNs such as the IDNA Protocol and with the IDN guidelines as updated and published from time to time on the ICANN website all subject to and within the limits of relevant applicable national law and public policy. This includes but is not limited to adherence to RFCs 3490 3491 3492 3454 and their successors.

d. **Accuracy and Completeness of Information:** notify ICANN through ICANN's designated point of contact of:

- 1) any change of the contact information of its administrative or technical contact(s) and
- 2) any change to the administrative and /or technical contact details about [.] in the Authoritative-Root Database no later than seven days after the change becomes effective. The administrative contact for [.] must be directly associated with [IDN ccTLD SO] and must reside in the territory of [country].

**D. No implementation of DNS redirection and synthesized DNS responses.** [IDN ccTLD SO] agrees that for domain names which are either not registered by a domain name registrant or the domain name registrant has not supplied valid records such as NS records for listing in the DNS zone file or their status does not allow them to be published in the DNS: the use of DNS redirection and synthesized DNS responses as described in RFC 4592 or any other method or technology for synthesizing DNS Resources Records or using redirection within the DNS by the Registry is forbidden. In other words when queried for such domain names the authoritative name servers must return a "Name Error" response (also known as NXDOMAIN) RCODE 3 as described in RFC 1035 and related RFCs. This provision applies for all DNS zone files at all levels in the DNS tree for which the [IDN ccTLD SO] (or an affiliate engaged in providing Registration Services for the IDN ccTLD) maintains data or derives revenue from such maintenance.

**E. No conference of Intellectual Property rights in IDN Top Level Domain.** Nothing in this agreement shall confer any intellectual property rights or preferences in the TLD string.

**F. Voluntary Contribution.** [IDN ccTLD SO] shall on an expected but not mandatory basis contribute on an annual basis to ICANN's cost of operations in the amount 3% of the revenue from the registrations of domain names within [..]. However in the event that fewer than 20 000 domain names are registered within [..] for any year [IDN ccTLD SO] shall on an expected but not mandatory basis contribute 1% of the revenue from registrations of domain names within [..] or in the event that there are 20 000 – 50 000 domain names registered within [..] for any year [IDN ccTLD SO] shall on an expected but not mandatory basis contribute 2% of the revenue from registrations. Revenue from registrations shall be calculated by multiplying the number of domain name registrations in [..] by the per registration fee as reported by [IDN ccTLD SO] in local currency.

**G. Termination.** This DoR may only be terminated in the following circumstances:

- a. There has been a determination by arbitration under Section I that a party is in violation of the DoR and that party continues to behave in the same manner for a period stated in the arbitration decision or if no period is stated twenty-one days
- b. Either party will not or is unable to perform its duties under the DoR and has given written notice to such effect
- c. In the event either party shall voluntarily or involuntarily be subject to bankruptcy or insolvency proceedings and such proceedings are not dismissed within 60 (sixty) days
- d. By mutual consent of the parties or
- e. By either party in the event that a re-delegation takes place provided that in any re-delegation discussions the existence of this DoR shall be taken into account.

**H. Effects of Termination.** All obligations under this DoR shall cease. ICANN and [IDN ccTLD SO] are still obligated to perform their duties in accordance with this DoR to the extent this is within their powers and can be reasonably expected under the circumstances in order to maintain the stability security and interoperability of the DNS.

## **I. Cooperative Engagement.**

- a. In the event of an activity or lack of activity that generates a serious concern regarding the stability security and interoperability of the Internet's Domain Name System (DNS) from a global perspective or a disagreement between [IDN ccTLD SO] and ICANN arising under or out of this DoR either party may by notice to the other invoke the cooperative engagement provisions in this section.
- b. If either party provides written notice to the other demanding cooperative engagement then each party will within 7 (seven) calendar days designate by email a single executive officer as its representative to resolve the dispute.
- c. The designated representatives shall within 2 (two) business days after being designated confer by telephone or in person to attempt to resolve the dispute.
- d. If they are not able to resolve the dispute during such telephone conference or meeting they shall further meet in person at a location mutually agreed to within 7 (seven) calendar days after such initial meeting at which the parties shall attempt to reach a definitive resolution.
- e. The time schedule and process may be modified with respect to any dispute but only if Parties agree to a revised time schedule or process in writing.

## **J. Resolution of Disputes.**

- a. All disputes arising out of or in connection with the present agreement shall be finally settled under the Rules of Arbitration of the International Chamber of Commerce (ICC) provided however that before either party may initiate arbitration as provided in this section [IDN ccTLD SO] and ICANN must attempt to resolve the dispute by cooperative engagement as set forth in the previous section G.
- b. The arbitration shall be conducted in the English language.
- c. If the Parties cannot mutually agree on a location [PLACE Country] shall be the default location.
- d. There shall be three arbitrators: each party shall choose one arbitrator with the third chosen from the parties' arbitrators from the ICC list of arbitrators. If the parties' selected arbitrators cannot agree on the selection of the third arbitrator that third arbitrator shall be appointed according to the ICC Rules of Arbitration.
- e. Issues of law arising in connection with the interpretation of this DoR shall be resolved by the rules of law considered by the arbitrators to be most appropriately applied in all the circumstances provided that the validity interpretation and effect of acts of [IDN ccTLD SO] and its legal status at the start of the dispute shall be judged according to the laws of [Country of IDN ccTLD SO] and the validity interpretation and effect of acts of ICANN and its legal status shall be judged according to the laws of the State of California.
- f. The parties shall bear the costs of the arbitration as set forth in the Rules. The prevailing party in the arbitration shall have the right to recover its costs if an order for recovering costs is included in the arbitration award. The parties shall bear their own attorneys' fees in connection with the arbitration though the prevailing party may seek the recovery of reasonable attorneys' fees to be included in the arbitration award.
- g. The decision of the arbitration panel shall be final and binding on the parties as contemplated in the Rules while the parties each retain rights to apply for correction or interpretation of the award as specified in the Rules. The parties agree that any award of the arbitration panel may be enforced in any court of competent jurisdiction.

**K. No Liability.** The arbitrators shall have no authority to award consequential incidental indirect or punitive damages to either Party. [IDN ccTLD SO] and ICANN agree that irreparable damage could occur if any of the provisions of this Agreement are not performed in accordance with its specific terms. Accordingly the parties agree that they each shall be entitled to seek from the arbitrator's specific performance of the terms of this Agreement. No breach of an obligation under this DoR other than dispute resolution fees shall give rise to any monetary liability by one party to another. This Agreement shall not be construed to create any obligation by either ICANN or [IDN ccTLD SO] to any non-party to this Agreement.

**L. Transfer or Assignment.** No party may transfer assign or sub-contract this DoR or any of the party's obligations under this DoR without the prior written consent of the other party.

**M. Notice.** Any notices to be sent pursuant to this DoR shall be given in writing at the address of the appropriate party below unless this DoR authorizes a notice to be provided by email. Otherwise any notice required by this DoR shall be deemed to have been properly given when delivered in person when sent by electronic facsimile with receipt of confirmation of delivery or when scheduled for delivery by internationally recognized courier service.

If to ICANN addressed to:

Internet Corporation for Assigned Names and Numbers  
[Department]  
12025 Waterfront Drive Suite 300  
Los Angeles CA 90094-2536  
USA  
Attention: [Responsible Person]  
Telephone: 1/310/823-9358  
Facsimile: 1/310/823-8649  
e-mail: [\_\_\_\_@icann.org]

If to [IDN ccTLD SO] addressed to:

[IDN ccTLD SO] a [organization type and jurisdiction]  
[Courier Address]  
[Mailing Address]  
Attention: [contact person]  
Telephone: [telephone number]  
Facsimile: [fax number]  
e-mail: [e-mail address]

**Entire Agreement.** This DoR contains the entire agreement of the parties in relation to the subject matter contained within it. No variation of this DoR shall be binding unless it is in writing and signed by both parties.

---

**[Signature, ICANN President] [Signature, IDN ccTLD SO Rep]**

---



*Proposed ICANN to IDN ccTLD Exchange of Letter*

---

**[ICANN Letterhead]**

**[date]**

**[name of IDN ccTLD/]**

**[address of IDN ccTLD]**

Dear [ ]

This letter sets out what ICANN has agreed to do in order to demonstrate commitment to securing and enhancing the stability and interoperability of the Internet's Domain Name System (DNS). This is for the mutual benefit of [organization name] and ICANN and for the benefit of the local and global internet community.

To this end ICANN makes the following commitments to [organization name].

ICANN shall use best endeavours to:

- a) Maintain a stable secure and authoritative publicly available database of relevant information about [.] the Delegated IDN country code Top Level Domain (Delegated IDN ccTLD) in accordance with ICANN publicly available policies and procedures. The Authoritative Root Database shall contain information for the public authoritative name servers for [.] contact information for .[ ] the designated administrative contact(s) and the designated technical contact(s) as notified to ICANN.
- b) Initiate on notification by the [organization name] a change to the domain name or IP address(es) of the name servers for [.] as recorded in the Authoritative-Root Data for [.] in the Authoritative-Root Database according to ICANN's publicly available policies and procedures. The initial format and technical requirements for such a change are set out in our publicly available policies and procedures
- c) Publish data maintained in the Authoritative Root Database about [.] which shall include at least the names of [organization name] as the Sponsoring Organization the administrative contact(s) the technical contact(s) and the domain names and IP addresses of the authoritative name servers for the domain
- d) Coordinate the Authoritative Root Server System so that it is operated and maintained in a stable and secure manner and support a process that causes the Authoritative Root Server System to publish DNS resource records delegating the Delegated IDN ccTLD [.] to the name servers recorded in the Authoritative Root Database and to inform the named administrative contact(s) and technical contact(s) of the published changes to the name servers for [.]
- e) Maintain authoritative records and an audit trail regarding changes to [.] delegations and records related to those delegations and inform [organization name] of the status of a requested change related to [.] in accordance with the policies procedures and format as made publicly available by ICANN

- f) Notify [organization name] of any changes to ICANN's contact information no later than seven (7) days after the change becomes effective and
  
- g) In the event of an activity or lack of activity that generates a serious concern regarding the stability security and interoperability of the Internet's Domain Name System (DNS) from a global perspective or there is disagreement between ICANN and [organization name] (the "parties") arising under or out of the commitments made in this exchange of letters either party may provide written notice to the other demanding cooperative engagement. In that event then each shall within 7 (seven) calendar days of the provision of the notice designate by email a single executive officer as its representative to resolve the dispute. [Organization name] may send notifications to [email address@icann.org]. The designated representatives shall within 2 (two) business days after being designated confer by telephone or in person to attempt to resolve the issue in good faith. If they are not able to resolve the issue during the initial meeting the designated representatives shall meet in person at a mutually agreed location within 7 (seven) calendar days after the initial meeting at which meeting the designated representatives shall in good faith attempt to reach a definitive resolution of the issue. This time schedule and process for cooperative engagement may be modified with respect to any issue but only if both parties agree to such a modification in writing

ICANN acknowledges that the [.] IDN ccTLD has been selected in [name of territory] in [year] and endorsed amongst others by the relevant public authority as a meaningful representation of the name of the territory. By signing this letter no intellectual property rights or preferences in the aforementioned IDN ccTLD string are conferred by the selection and delegation of the IDN ccTLD.

ICANN acknowledges that [organization name] has committed to make an expected but not mandatory financial contribution to ICANN's costs of operations. ICANN appreciates this commitment to furthering ICANN's ability to fulfill its mission as set forth in Sections 1 and 2 of the ICANN Bylaws.

ICANN may terminate its commitment to you by giving you notice in writing. In this event ICANN's obligations to [organization name] under this letter shall cease. However ICANN acknowledges its responsibility to continue to perform all commitments including the cooperative engagement process as described in paragraph g) to the extent it is within ICANN's powers and can be reasonably expected under the circumstances in order to maintain the stability and interoperability of the DNS.

ICANN agrees that no breach of a commitment contained in this letter or performance or non-performance under this letter shall give rise to any monetary liability by either ICANN or [organization name]. The exchange of letters between ICANN and [organization name] represents the full agreement and commitments of the parties.

ICANN looks forward to a long and mutually beneficial relationship with [organization name].

Yours sincerely

Rod Beckstrom

President and CEO

Internet Corporation for Assigned Names and Numbers

## *Proposed Example of IDN ccTLD to ICANN Exchange of Letter*

---

To: ICANN  
12025 Waterfront Drive Suite 300  
Los Angeles CA 90094-2536  
USA

This letter sets out what [organization name] understands it has agreed to do in order to demonstrate [organization name]'s commitment to securing and enhancing the stability and interoperability of the Internet's Domain Name System (DNS) for [organization name] and ICANN's mutual benefit and for the benefit of the local and global internet community in an evolutionary manner and on the basis of a peer relationship.

[Organization name] acknowledges that ICANN is the entity responsible for maintaining and keeping the root of the Internet DNS stable and globally interoperable in a manner that is consistent with ICANN's Mission and Core Values as reflected in its bylaws

To this end [organization name] makes the following commitments to ICANN. [Organization name] shall use its best endeavours to:

- a. Generate regular updates of the [.] zone data in compliance with relevant standards as set out in paragraph c) and subject to and within the limits of relevant national law and national public policy.
- b. Establish, operate and maintain the authoritative name servers for [.] in a stable and secure manner, adequate to resolve names within the [.] domain by users throughout the Internet and in compliance with relevant standards as set out in paragraph d) and subject to and within the limits of relevant national law and national public policy.
- c. Register IDN domain names in accordance with [organization name]'s publicly-available registration policy which shall comply on an ongoing basis with Relevant Applicable Standards to IDNs such as the IDNA Protocol and with the IDN guidelines as updated and published from time to time on the ICANN website, all subject to and within the limits of relevant applicable national law and public policy. . This includes, but is not limited to, adherence to RFCs 3490, 3491, 3492, 3454 and their successors.
- d. Applicable relevant standards are standards-track or best current practice RFCs sponsored by the Internet Engineering Task Force.
- e. Notify ICANN through ICANN's designated point of contact of:

1. Any change of the contact information of the administrative or technical contact(s) and
2. Any change to the administrative and /or technical contact details about [.] in the Authoritative-Root Database no later than seven days after the change becomes effective. The administrative contact for [.] must be directly associated with [IDN ccTLD] and must reside in the territory of [country or territory] during the entire period he or she is designated as such.

[Organization name] agrees that for domain names which are either not registered by a domain name registrant or the domain name registrant has not supplied valid records such as NS records for listing in the DNS zone file or their status does not allow them to be published in the DNS: the use of DNS redirection and synthesized DNS responses as described in RFC 4592 or any other method or technology for synthesizing DNS Resources Records or using redirection within the DNS by the Registry is forbidden. In other words when queried for such domain names the authoritative name servers must return a "Name Error" response (also known as NXDOMAIN) RCODE 3 as described in RFC 1035 and related RFCs. This provision applies for all DNS zone files at all levels in the DNS tree for which [organization name] (or an affiliate engaged in providing Registration Services) maintains data arranges for such maintenance or derives revenue from such maintenance. [Alternative language: [Organization name] agrees that the [.] IDN ccTLD should not use DNS redirection and synthesized DNS responses.]

[Organization name] shall on an expected but not mandatory basis contribute on an annual basis to ICANN's cost of operations in the amount 3% of the revenue from the registrations of domain names within [.] . However in the event that fewer than 20 000 domain names are registered within [.] for any year [organization name] shall on an expected but not mandatory basis contribute 1% of the revenue from registrations of domain names within [.] or in the event that there are 20 000 – 50 000 domain names registered within [.] for any year [organization name] shall on an expected but not mandatory basis contribute 2% of the revenue from registrations. Revenue from registrations shall be calculated by multiplying the number of domain name registrations in [.] by the per registration fee as reported by [organization name] in local currency.

[Organization name] agrees that it may terminate our commitment to ICANN by giving ICANN notice in writing and if [organization name] does [organization name] agrees that its obligations to ICANN under this letter shall cease. However [organization name] acknowledges that it are to continue to perform its commitments including the cooperative engagement process described below to the extent it is within [organization name]'s powers and can be reasonably expected under the circumstances in order to maintain the stability and interoperability of the DNS.

[Organization name] agrees that it will engage with ICANN in the event of an activity or lack of activity that generates a serious concern regarding the stability security and interoperability of the Internet's Domain Name System (DNS) from a global perspective or there is disagreement between ICANN and [IDN ccTLD manager] (the "parties") arising under or out of the commitments made in this exchange of letters. [Organization name] agrees that either party may provide written notice to the other demanding cooperative engagement. In that event then each shall within 7 (seven) calendar days of the provision of the notice designate by email a single executive officer as its representative to resolve the dispute. ICANN may send notifications to [email address@IDN ccTLD]. The designated representatives shall within 2 (two) business days after being designated

confer by telephone or in person to attempt to resolve the issue in good faith. If they are not able to resolve the issue during the initial meeting the designated representatives shall meet in person at a mutually agreed location within 7 (seven) calendar days after the initial meeting at which meeting the designated representatives shall in good faith attempt to reach a definitive resolution of the issue. This time schedule and process for cooperative engagement may be modified with respect to any issue but only if both parties agree to such a modification in writing

[Organization name] agrees that the delegation of the IDN ccTLD does not grant an intellectual property right in the [..] string.

[Organization name] agrees that no breach of a commitment contained in this letter or performance or non-performance under this letter shall give rise to any monetary liability by either one of us to the other. The exchange of letters between ICANN and [IDN ccTLD Sponsoring Organization] represents the full agreement and commitments of the parties.

[Organization name] looks forward to a long and mutually beneficial relationship with ICANN.

[Signature]

# Module 8

## *Fee Structure and Model*

This module contains a description of the fee structure and model associated with the Fast Track process. ICANN posted the following three papers for discussion at the ICANN Sydney meeting (22-26 June 2009)

- Proposed Implementation Details Regarding Financial Contributions to Support the Development and Deployment of IDN ccTLDs
- Cost Analysis of IDN ccTLDs: Focus on Program Development and Processing Costs
- ICANN Expenditure Analysis: by Stakeholder Interest Area

See <http://www.icann.org/en/topics/idn/fast-track/> for details.

Combined those papers suggest that ICANN receives proposed (expected but not mandatory) fees in the amounts described below.

In September 2009 ICANN undertook a detailed re-analysis of the processing fee based on progress made in development of the evaluation process. The re-evaluation resulted in a slightly lower (within 5%) fee – within the error of the estimate. Therefore the processing fee is unchanged.

The community has expressed broadly ranging opinions on this matter.

Based on detailed financial analysis the following constitutes the IDN ccTLD Fast Track Fee structure:

- A pre-arranged and recommended revenue-neutral IDN ccTLD evaluation processing fee of US \$26 000 (rounded).

A processing fee notice will be sent to the requester upon receipt of an IDN ccTLD request. The processing fee can be paid in local currency.

Requesters unable to pay this fee can contact ICANN and request fee waiver.

The processing fee can be paid in local currency.

- A pre-arranged and recommended annual cost contribution fee of 3% of revenue payable in local currency (1-2% for low volume registries).

The annual contribution fee is included as the expected annual contribution fee in the DoR and in the EOL.

The annual contribution will be based on a statement detailed by the IDN ccTLD Manager. ICANN will not request the necessary revenue-related information.

The annual contribution fee can be paid in local currency.

If the registry wishes to use a different model (other than the percent of revenue model) that arrives at the same general level of contribution that contribution will be welcomed by ICANN. ICANN will maintain accounting of all ccTLD contributions and continue to compare those contributions against costs for supporting the ccTLDs.

IDN ccTLD managers unable to pay this fee can contact ICANN and request fee waiver.

After the IDN Fast Track request is processed successfully the standard IANA delegation procedure will occur. There is no fee for this service. IANA delegation costs were not included in the costs to process IDN ccTLD requests.

A detailed overview of the costs expected in the various steps of processing the IDN string evaluation request is included in Appendix 1 to this Module 8.

# Appendix 1 to Module 8

## Detailed overview of obtained costs in the processing of an IDN ccTLD Fast Track request

### IDN ccTLD Fast Track Processing Cost

Tasks	Probability	Step Description	Comments	Total Hours	Internal Costs per Request	Total variable costs	Total Fixed Costs
1	100%	Submission of Request	Some requests will require support to answer questions prior to submittal.	40	\$ 4,120	\$ 4,120	
2	100%	Request Completeness Validation	Internal staff only. Most requests are anticipated to be straight forward. This will include a quick technical check by staff.	10	\$ 1,030	\$ 1,030	
3	100%	Linguistic Process Validation	Internal staff only.	10	\$ 1,030	\$ 1,030	
4	100%	DNS Stability Evaluation	DNS Stability Panel check is fixed cost for 2 years of operation. Contract has been signed with Interisle Consulting Group.	20	\$ 2,060	\$ 2,060	\$ 200,000
5	100%	Publish String	Internal staff only.	10	\$ 1,030	\$ 1,030	
6	100%	Ongoing IT Support	1/4 FTE stand-by IT support.				\$ 50,000
7	100%	Ongoing Legal Support	Legal support.				\$ 200,000
8	100%	Ongoing Communications Support	Communication and reporting support.				\$ 100,000
9	100%	Other Support Costs	Translations, interpretations, publications.				\$ 50,000
				<b>90</b>	<b>\$ 9,270</b>	<b>\$ 9,270</b>	<b>\$ 600,000</b>
<b>Total Cost</b>							<b>\$ 1,063,500</b>
<b>Expected # of requests</b>							<b>50</b>
<b>Cost per request</b>							<b>\$ 21,270.00</b>
<b>Contingency (20%)</b>							<b>\$ 4,254.00</b>
<b>Total Processing Fee / Request</b>							<b>\$ 25,524.00</b>



# Module 9

## *Process Review and Revision*

This module contains a description of the review function of the IDN ccTLD Fast Track Process. While IDN TLDs are considered safe to introduce in a limited fashion in the DNS at the time of launch of the IDN ccTLD Fast Track Process it is also anticipated that several areas related to IDNs and in particular to IDN TLDs will continue to evolve over time.

Accordingly a review function of the process has been established.

One example of a potential result of such a review could be the inclusion of a process for delegation of desired IDN TLD variants that are reserved for the purpose of the Fast Track Process.

### ***Review Schedule***

The review will take place at least annually and will be initiated with an ICANN announcement asking for community feedback on all elements of the process.

Staff will review the received feedback. Based on the feedback a recommended approach for revision will be developed and released for public comments. An update of the proposal will be issued following the second round of received public comments.

The updated proposal will be provided to the ICANN Board for their consideration.

Following positive Board consideration the proposed changes will be implemented. All requests in process of being evaluated at the time of release of the proposed changes will be completed per the requirements in the existing IDN ccTLD Fast Track Process. Exceptions to this approach would include any measures to resolve identified security and stability issues.

Additionally identified security and stability issues may prompt more frequent reviews than the scheduled annual cycle.

# Module 10

## Background Information

One of the most significant innovations for the Internet since its inception will be the introduction of top level Internationalized Domain Names (IDN TLDs). These IDN TLDs will offer many new opportunities and benefits for Internet users around the world by allowing them to establish and use domains in their native languages and scripts.

IDNs have been discussed in the ICANN community for many years. Initially development focused on enabling the introduction of IDNs as registrations under existing top-level domains (TLDs) but in the most recent year focus has shifted to broadening of the character repertoire available for use in top level strings.

Over the past years the introduction of IDN gTLDs was discussed in the context and as part of the [New gTLD Program](#).

The formal consultation and discussion on the introduction of IDN ccTLDs<sup>3</sup> was [initiated by the ICANN Board](#) at its meeting in São Paulo (December 2006). The Country Code Names Supporting Organization (ccNSO) and the Governmental Advisory Committee (GAC) were asked to collaborate in consultation with the relevant technical community to produce an issues paper on the selection of IDN ccTLDs associated with the two-letter codes described in the ISO 3166-1 standard.

The ccNSO and GAC formed a joint IDN working group (IDNC WG) that published and submitted to the ICANN Board a list of issues relating to the introduction of IDN ccTLDs in June 2007.

Consultations and discussions of the IDN working group made it clear that several countries and territories have a pressing need for IDN ccTLDs. This realization initiated a discussion of the provisions needed for an interim approach to IDN ccTLDs to meet near-term demands and to gain experience with mechanisms for selecting and authorizing such TLDs that can inform a policy development process. The ICANN Board requested the ICANN community including the Generic Names Supporting Organization (GNSO) ccNSO GAC and the At-Large Advisory Committee (ALAC) to collaboratively explore both an interim and an overall approach to IDN ccTLDs and recommend a course of action to the Board ([ICANN meeting San Juan June 2007](#)).

Following a ccNSO Council recommendation and broad support of the ICANN community including the GAC GNSO and ALAC the ICANN Board asked the ALAC ccNSO GAC and GNSO chairs to set up an IDNC Working Group appoint its members and begin work in accordance with its [Charter](#) as soon as possible.

The IDNC WG was tasked to recommend mechanisms to introduce a limited number of non-contentious IDN ccTLDs associated with the ISO 3166-1 two-letter codes to meet near-term demand while the overall policy is being developed.

---

<sup>3</sup> The shorthand term IDN ccTLDs refers to new top-level domains associated with entries in the ISO 3166-1 list.

At the ICANN meeting in Paris (June 2008) the IDNC WG submitted its Final Report to the Board including GAC and ccNSO statements on the proposed methodology. At its meeting in Paris the Board resolved:

*Resolved (2008.06.26.04), the Board thanks the members of the IDNC WG for completing their chartered tasks in a timely manner.*

*Resolved (2008.06.26.05), the Board directs staff to: (1) post the IDNC WG final report for public comments; (2) commence work on implementation issues in consultation with relevant stakeholders; and (3) submit a detailed implementation report including a list of any outstanding issues to the Board in advance of the ICANN Cairo meeting in November 2008.*

ICANN then posted the IDNC WG Final Report for public comments and began implementation as directed. Following the public comment period ICANN posted a consolidated overview of the comments received and a document containing staff considerations of the comments received. During implementation planning ICANN also submitted letters to relevant public authorities and ccTLD managers to seek information on their interest in participating in the Fast Track Process.

This document is the Proposed Final Implementation Plan.

The initial draft and the first revision of the Implementation Plan were posted right before and immediately following the ICANN meeting in Cairo Egypt 1-7 November 2008 the second revision was posted before the ICANN meeting in Mexico City Mexico 1-6 March 2009 and the third was posted prior to the ICANN meeting in Sydney 22-26 June 2009.

In preparing this proposed final plan ICANN took into consideration the comments received on the previous versions in particular public comments and input received through meetings such as the ICANN meetings in Cairo Mexico and Sydney as referenced above.

The analysis of received comments is released in separate documents.

The Proposed Final Implementation Plan is released for public consumption and for the ICANN Board consideration during the ICANN meeting in Korea Seoul 26-30 October 2009.

This is in response to the ICANN Board resolution during the ICANN meeting in Mexico City Mexico:

*It is resolved (2009.03.06.03), that the Board thanks the ICANN community for its work to date and encourages it to continue its work so that the implementation plan can be finalized and considered by the Board no later than at its annual meeting in 2009.*

A full overview of activities and links to the materials related to the IDN ccTLD Fast Track Process and its implementation can be viewed at <http://www.icann.org/en/topics/idn/fast-track/>.

A glossary of IDN terms used throughout this document is available at <http://www.icann.org/en/topics/idn/idn-glossary.htm>.

The Panel will consist of six experts, with the ability of the Panel to call upon linguistic expertise in consultation with ICANN.

Panel members will be experts in the design, management and implementation of the complex systems and standards-protocols utilized in the Internet infrastructure and DNS. Panel members must have expertise in the technology and practical implementation and deployment of the DNS in the Internet, and knowledge of Internationalized Domain Names and the IDNA Protocol.

ICANN will create batches of strings received for the Fast Track Process on a monthly basis, starting one month following the launch of the process, and deliver the batches to the Panel for review.

4.1

None of the RT members shall have an existing competitive, financial, or legal conflict of interest, and members shall be selected with due regard to the particular technical issues raised by the referral.

#### DNS Stability Evaluation: sub-process of IDN ccTLD FT process

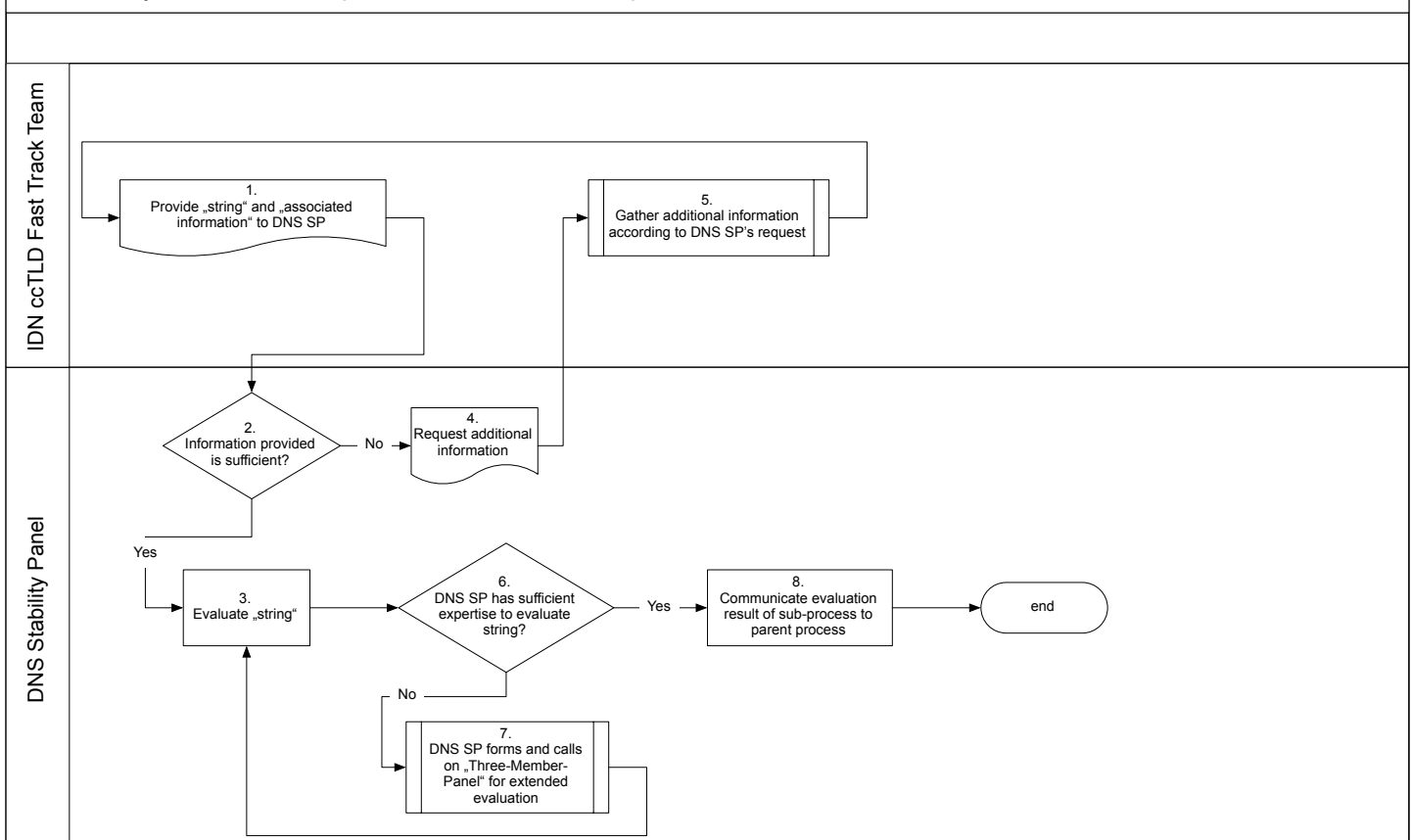

**2013-06-27-02c-Reference Mateirals-Annex-2013  
RAA.doc**

## REFERENCE MATERIALS

### ANNEX TO BOARD SUBMISSION NO. 2013-06-27-02c

**SUBMISSION TITLE: 2013 RAA**

#### **Formation of the 2013 RAA**

In 2009, the GNSO Council embarked on a collaborative process with the At Large Advisory Committee regarding the RAA. As part of this process, a joint GNSO/ALAC drafting team was formed (known as the RAA Drafting Team or, “RAA DT”) to consider various proposals for improvements to the RAA. The RAA DT reviewed proposals from the law enforcement community, the Intellectual Property Constituency, as well as other stakeholders. The RAA DT published a [Final Report](#) on 18 October, 2010, that identified potential topics to be addressed in an amended RAA. The RAA DT also proposed several next steps for the GNSO Council to consider in determining whether to recommend a new form of RAA.

Prior to the October 2011 ICANN meeting in Dakar, Senegal, Staff published a [Discussion Paper on the Next Steps for the RAA](#) that recommended the immediate commencement of bilateral negotiations with the Registrars. At the Dakar meeting, law enforcement representatives and other stakeholders debated the need for additional amendments to the RAA.

In Dakar, the ICANN Board adopted a resolution (2011.10.28.31)  [<http://www.icann.org/en/minutes/resolutions-28oct11-en.htm#7>](http://www.icann.org/en/minutes/resolutions-28oct11-en.htm#7) acknowledging that the effort to evolve the RAA is an important element in a program to protect registrants and safeguard the stability of a single interoperable Internet. The resolution called for immediate negotiations and called on the negotiating teams to publish proposed amendments for consideration at ICANN’s meeting in Costa Rica in March 2012. The Board resolution called on the negotiating teams to address of law enforcement and GNSO working group recommendations as well as other topics that would advance the twin goals of registrant protection and DNS stability. The ICANN Board also directed Staff to prepare an Issues Report with respect to any remaining items suited for a PDP.

The Registrars Stakeholder Group and ICANN announced in Dakar the immediate commencement of negotiations on the RAA.

ICANN and the Registrars discussed the following topics in these negotiations:

- The law enforcement RAA recommendations, including as formulated by law enforcement in its proposed code of conduct;
- The “High Priority” recommendations from the joint GNSO/ALAC RAA Drafting Team’s Final Report (see [Final Report](#));
- To the extent time permits, the “Medium Priority” recommendations from the joint GNSO/ALAC RAA Drafting Team’s Final Report;
- Other topics that would advance the goals of registrant protection, DNS stability, and increased predictability for all stakeholders.

ICANN and the Registrar Negotiating Team (NT), which is a group of representatives selected by the Registrar Stakeholder Group, held numerous face-to-face and telephonic meetings over the period from November 2011 and April 2013 when the proposed final 2013 RAA was posted for public comment. Over 25 sessions occurred by October 2012. ICANN’s new executive team then took an active role in bringing the negotiations to a close, and negotiations then resumed in earnest at the beginning of 2013, with negotiation sessions occurring nearly every other day as ICANN and the Registrars reached agreement on all items remaining outstanding within the negotiations.

ICANN and the Registrars have reported to the community on the status of the RAA negotiations at every ICANN meeting since Dakar, including sessions in Costa Rica, Prague, Toronto and Beijing. Prior to the Beijing meeting, in March 2013, ICANN and the Registrars posted a draft 2013 RAA, while noting that a few areas of difference still remained: removing the Registrar’s requirement to provide Port 43 access for “thick” registries; the scope of a Board-approved amendment clause; and whether Registrars would verify an element of information relating to the account holder for a domain name registration. Because of the continuing negotiations, ICANN and the Registrars announced in Beijing that they had reached agreement in principle on each of the

remaining areas of difference. The proposed final 2013 RAA was posted for public comment on 22 April 2013.

### **Summary of Improvements in the 2013 RAA**

The 2013 RAA includes provisions addressed to improve the image of the domain industry and to protect registrants through a further updated contractual framework. The 2013 RAA reflects hard-fought concessions on many of key issues raised throughout the negotiations, as well as issues raised within public comment. The 2013 RAA, represents a significant improvement over the current 2009 version, and significantly raises performance requirements for every ICANN accredited registrar, thereby bringing dramatic improvements to the domain name ecosystem.

The highlights of this proposed 2013 RAA include:

- **The 12 Law Enforcement Recommendations** that served as the impetus for these negotiations are all addressed in this proposed draft. The Law Enforcement Summary Chart (attached as an identifies the section or specification of the 2013 RAA that addressed each recommendation. Some of the highlights include the creation of an abuse point of contact at each registrar, Whois verification and validation requirements at the registrant and the account holder levels, stronger language on registrar obligations for resellers, and new data retention obligations.
- **Enhanced Compliance Tools** including broader suspension and termination tools, clarification of audit rights and access to information to facilitate ongoing investigations, and annual certification requirements.
- **A Registrant Rights and Responsibilities Document** that sets out, in clear and simple language, the rights and responsibilities that are set out in the 2013 RAA, such as the types of information that registrants can expect to be made available to them about terms and conditions of registrations, fees and customer service processes. The document also emphasizes the registrant's role in providing accurate contact information, and responsibilities in maintaining domain name registrations. These enumerated rights and responsibilities are not



comprehensive of all registrant rights and responsibilities set out in consensus policies, however this document is closely tied to the terms of the 2013 RAA.

- **Registrar Responsibility for Reseller Compliance** with all appropriate terms of the RAA.
- **Consolidation with the Registry Agreement for New gTLDs.** Where appropriate, ICANN and the Registrar NT have agreed to mirror language from the Registry Agreement, to allow for contracts that are better aligned. The New gTLD Registry Agreement and the 2013 RAA are anticipated to complement each other as Registries and Registrars move towards agreements that better reflect the changing marketplace.
- **Proxy and Privacy Provider Interim Requirements.** ICANN and the Registrar NT have agreed to interim protections that will be in place for proxy and privacy services offered through registrars. These interim protections will require that information is made available on items such as customer service processes and when a provider will relay information on the underlying user of the domain name registration. While these are not comprehensive of the protections that some have requested to be put in place for proxy and privacy providers, these interim protections will provide a more responsible marketplace until a formal accreditation program is developed.

### **Community Response to the Proposed Final 2013 RAA**

Following on from the community comment in Beijing that was generally supportive of the advancements made in the negotiations and the potential of the 2013 RAA, most of the 19 commenters on the proposed final 2013 RAA spoke in favor of the 2013 RAA. Of course, many of those commenters identified improvements they wish to see implemented in the agreement prior to finalization.

The main areas of concern raised were the following:

- For Whois Accuracy, the IPC, BC and other commenters supported the use of pre-resolution verification, as opposed to allowing a 15-day window after resolution within which the verification could occur. This request for pre-

resolution verification has been raised previously in the negotiations, and because of the potential for large change to the domain name registration process, as well as the ongoing work to create a new method of dealing with gTLD Registration Data, it was determined – and explained to the community – that the pre-resolution verification was not feasible for introduction at this time, without further community work and development.

- Similarly there have been requests for verification of both an email and phone number, over registrar and other’s concerns that it is not always feasible – and in some areas of the world nearly impossible – to perform phone verification. Further changes in this areas were also deferred in favor of the ongoing work on gTLD Registration Data.
- For registrations through proxy and privacy service providers, multiple commenters called for (as they had been calling for throughout the RAA development process) verification of the data of the underlying customer. As we previously explained to the community, the forthcoming policy work on a Proxy and Privacy Accreditation Program will be place to develop these sorts of requirements, as the lines of enforcement will be clearer in that situation. In addition, many in the community opposed the introduction of this type of requirement at this time. Similarly, the community is currently not in consensus on the mechanism for more explicit requirements for the reveal and relay of underlying customer data, and though many have commented that ICANN should put those types of requirements in place now, that work has also been deferred to the larger community-based policy work on Accreditation. One common concern recently raised in regards to the proxy/privacy obligations set forth in the 2013 RAA was that we needed to be clearer about the applicability to resellers, and ICANN has taken that change on and it is reflected in the 2013 RAA as approved by the Board.
- Some commenters raised concerns about the new Registrant Rights and Responsibilities document, suggesting that it does not go far enough in recognizing more general rights and responsibilities. Because of the specific purpose of the Registrant Rights and Responsibilities specification – which is to

track to the terms of the 2013 RAA – we have clarified the title of the document to reflect that it is about *contractual* rights and responsibilities. If the community wishes to produce a broader declaration of the rights and responsibilities, nothing within the 2013 RAA would preclude that work.

- Some commenters noted concerns that the amendment processes put in place were too onerous for ICANN in the event that it wished to put an amendment in place over the objection of the Registrars. However, ICANN believes that the Board-approved amendment process reflected in the 2013 RAA is a balance that recognizes the role of policy development in the multistakeholder model, and though complex, provides a powerful mechanism in the event it ever needs to be invoked.
- While commenters were generally supportive of the 2013 RAA and the advancements that it brings, many of those same commenters noted dissatisfaction with the process that led to the development of the 2013 RAA. Many were dissatisfied that the negotiations were bilateral, without even an opportunity for community observation of the negotiation sessions, let alone the ability to propose language during the negotiations. While it is too late to modify the process used previously, it is important to recall that the RAA itself did not include any path to negotiation; the process to be used was not clear. To help assure that the community will have a voice in future amendments to the RAA, the RAA now incorporates specific public comment requirements when amendments are under consideration or negotiations have been initiated.

Included here is a summary of some of key concerns raised. The full summary and analysis of the public comment, which also identifies areas where the 2013 RAA reflects modifications in response to comments received, is provided as Attachment E. Attachment F provides the March 2013 public comment summary and analysis, which shows the similarity in some of the comments received.

Outside of the comment period, in its Beijing Communiqué, the GAC noted its appreciation for the improvements to the RAA that incorporate the 2009 GAC-Law Enforcement Recommendations, and also noted that it is pleased with the progress on providing verification and improving accuracy of registrant data and supports

continuing efforts to identify preventative mechanism that help deter criminal or other illegal activity.

ICANN has been engaged in ongoing work with registrar representatives on how to address concerns around implementation of cross-field validation (ex: street exists in city, city exists in state, etc.) and part of the clarifications provided in the 2013 RAA reflect the status of that work. ICANN also provided clarification to the language regarding cross-field validation to confirm the purpose of the provision.

To help assure that registrars are in agreement with the revisions in response to public comment, ICANN is reaching out to the registrars in consultation.

### **Import of Decision Today**

It is important for the 2013 RAA to be approved at this time, as the Board has accepted the GAC Advice in the Beijing Communiqué that the “the 2013 Registrar Accreditation Agreement should be finalized before any new gTLD contracts are approved.”

Approving the 2013 RAA now allows the Board to meet this advice. In addition, ICANN has made multiple representations to the community that the 2013 RAA will be in place prior to the delegation of new gTLDs. Approving the 2013 RAA now also gives ICANN and the registrars certainty of the new terms that will be applicable, and allows both ICANN and the registrars to move forward with implementation work to meet the heightened obligations.

### **Next Steps**

In the event the Board approves the 2013 RAA, ICANN and the Registrars will each need to take steps to implement the new RAA. This includes executing agreements with eligible registrars, and assuring that newly accredited registrars are brought onto the 2013 RAA.

One of the key things that ICANN has committed to with the Registrar Stakeholder Group is to work on educational outreach to help assure that all registrars understand the new obligations of the new agreement, as there are significant areas of change. ICANN and the Registrar NT also identified areas where further transition work is needed, including addressing some of the registrar concerns over the issues of

implementation of cross-field validation. It will also be important for ICANN to perform educational outreach to make sure that registrants also understand the changing obligations under the 2013 RAA.

### **Attachments**

Attachment A – 2013 RAA base agreement with Redline from 22 April 2013 posted version

Attachment B – Specifications to the 2013 RAA, including redlines from the posted versions where applicable

Attachment C – Summary of Changes to the 2013 RAA compared to the 22 April 2013 posted version

Attachment D – Summary of how law enforcement recommendations were incorporated into agreement

Attachment E – 22 April 2013 Public Comment Summary and Analysis

Attachment F – March 2013 Public Comment Summary and Analysis

Submitted by:	Samantha Eisner
Position:	Senior Counsel
Date Noted:	20 June 2013
Email:	<a href="mailto:Samantha.eisner@icann.org">Samantha.eisner@icann.org</a>

# 2013-06-27-02c-Ref Mat-Attachment A-2013 RAA.pdf



## Registrar Accreditation Agreement

---

This REGISTRAR ACCREDITATION AGREEMENT (this "Agreement") is by and between the Internet Corporation for Assigned Names and Numbers, a California non-profit, public benefit corporation ("ICANN"), and [Registrar Name], a [Organization type and jurisdiction] ("Registrar"), and shall be deemed made on \_\_\_\_\_, at Los Angeles, California, USA.

**1. DEFINITIONS.** For purposes of this Agreement, the following definitions shall apply:

1.1 "Account Holder" means the person or entity that is paying for the Registered Name or otherwise controls the management of the registered name, when that person or entity is not the Registered Name Holder.

1.2 "Accredited" or "Accreditation" means to identify and set minimum standards for the performance of registration functions, to recognize persons or entities meeting those standards, and to enter into an accreditation agreement that sets forth the rules and procedures applicable to the provision of Registrar Services.

1.3 "Affiliate" means a person or entity that, directly or indirectly, through one or more intermediaries, Controls, is controlled by, or is under common control with, the person or entity specified.

1.4 "Affiliated Registrar" is another Accredited registrar that is an Affiliate of Registrar.

1.5 "Applicable Registrar Family" means, with respect to Affiliated Registrars, such Affiliated Registrar as a group.

1.6 "Consensus Policy" has the meaning set forth in the Consensus Policies and Temporary Policies Specification attached hereto.

1.7 "Control" (including the terms "controlled by" and "under common control with") means the possession, directly or indirectly, of the power to direct or cause the direction of the management or policies of a person or entity, whether through the ownership of securities, as trustee or executor, by serving as an employee or a

member of a board of directors or equivalent governing body, by contract, by credit arrangement or otherwise.

1.8 "DNS" refers to the Internet domain-name system.

1.9 The "Effective Date" is \_\_\_\_\_.

1.10 The "Expiration Date" is \_\_\_\_\_.

1.11 "gTLD" or "gTLDs" refers to the top-level domain(s) of the DNS delegated by ICANN pursuant to a registry agreement that is in full force and effect, other than any country code TLD (ccTLD) or internationalized domain name (IDN) country code TLD.

1.12 "gTLD Zone-File Data" means all data contained in a DNS zone file for the registry, or for any subdomain for which Registry Services are provided and that contains Registered Names, as provided to nameservers on the Internet.

1.13 "Illegal Activity" means conduct involving use of a Registered Name sponsored by Registrar that is prohibited by applicable law and/or exploitation of Registrar's domain name resolution or registration services in furtherance of conduct involving the use of a Registered Name sponsored by Registrar that is prohibited by applicable law.

1.14 "Personal Data" refers to data about any identified or identifiable natural person.

1.15 "Registered Name" refers to a domain name within the domain of a gTLD, whether consisting of two (2) or more (e.g., john.smith.name) levels, about which a gTLD Registry Operator (or an Affiliate or subcontractor thereof engaged in providing Registry Services) maintains data in a Registry Database, arranges for such maintenance, or derives revenue from such maintenance. A name in a Registry Database may be a Registered Name even though it does not appear in a zone file (e.g., a registered but inactive name).

1.16 "Registered Name Holder" means the holder of a Registered Name.

1.17 The word "registrar," when appearing without an initial capital letter, refers to a person or entity that contracts with Registered Name Holders and with a Registry Operator and collects registration data about the Registered Name Holders and submits registration information for entry in the Registry Database.

1.18 "Registrar Approval" means the receipt of either of the following approvals:

1.18.1 The affirmative approval of Applicable Registrars accounting for 90% of the Total Registered Names Under Management by the Applicable Registrars; provided that, for purposes of calculating the Total Registered



Names Under Management by Applicable Registrars, the Total Registered Names Under Management by each Applicable Registrar Family shall not exceed the Total Registered Names Under Management of the Applicable Registrar Family that is the fifth largest Applicable Registrar Family (measured by number of Registered Names Under Management), both for purposes of the numerator and the denominator; or

1.18.2 The affirmative approval of 50% plus one of the Applicable Registrars that participate in the process to approve or disapprove (i.e. vote for or against, but not abstain or otherwise fail to vote) a proposed amendment under Section 6, and the affirmative approval of Applicable Registrars accounting for 66.67% of the Total Registered Names Under Management by all Applicable Registrars; provided that, for purposes of calculating the Total Registered Names Under Management by Applicable Registrars, the Total Registered Names Under Management by each Applicable Registrar Family shall not exceed the total Registered Names Under Management of the Applicable Registrar Family that is the fifth largest Applicable Registrar Family (measured by number of Registered Names Under Management), both for purposes of the numerator and the denominator. An example of these calculations is set forth in Appendix 1 attached hereto.

1.19 "Registrar Services" means the services subject to this Agreement provided by a registrar in connection with a gTLD, and includes contracting with Registered Name Holders, collecting registration data about the Registered Name Holders, and submitting registration information for entry in the Registry Database.

1.20 "Registry Data" means all Registry Database data maintained in electronic form, and shall include gTLD Zone-File Data, all data used to provide Registry Services and submitted by registrars in electronic form, and all other data used to provide Registry Services concerning particular domain name registrations or nameservers maintained in electronic form in a Registry Database.

1.21 "Registry Database" means a database comprised of data about one or more DNS domain names within the domain of a registry that is used to generate either DNS resource records that are published authoritatively or responses to domain-name availability lookup requests or Whois queries, for some or all of those names.

1.22 A "Registry Operator" is the person or entity then responsible, in accordance with an agreement between ICANN (or its assignee) and that person or entity (those persons or entities) or, if that agreement is terminated or expires, in accordance with an agreement between the US Government and that person or entity (those persons or entities), for providing Registry Services for a specific gTLD.

1.23 "Registry Services," with respect to a particular gTLD, shall have the meaning defined in the agreement between ICANN and the Registry Operator for that gTLD.

1.24 A “Reseller” is a person or entity that participates in Registrar’s distribution channel for domain name registrations (a) pursuant to an agreement, arrangement or understanding with Registrar or (b) with Registrar’s actual knowledge, provides some or all Registrar Services, including collecting registration data about Registered Name Holders, submitting that data to Registrar, or facilitating the entry of the registration agreement between the Registrar and the Registered Name Holder.

1.25 “Restricted Amendment” means (i) an amendment of the Consensus Policies and Temporary Policies Specification or (ii) the term of this Agreement as specified in Section 5.1, as such term may be extended pursuant to Section 5.2.

1.26 A Registered Name is "sponsored" by the registrar that placed the record associated with that registration into the registry. Sponsorship of a registration may be changed at the express direction of the Registered Name Holder or, in the event a registrar loses Accreditation, in accordance with then-current ICANN Specifications and Policies.

1.27 “Specifications and/or Policies” include Consensus Policies, Specifications (such as the Whois Accuracy Program Specification) referenced in this Agreement, and any amendments, policies, procedures, or programs specifically contemplated by this Agreement or authorized by ICANN’s Bylaws.

1.28 "Term of this Agreement" begins on the Effective Date and continues to the earlier of (a) the Expiration Date, or (b) termination of this Agreement.

1.29 “Total Registered Names Under Management” means the total number of Registered Names sponsored by all Applicable Registrars as reflected in the latest monthly reports submitted to ICANN by Registrars.

1.30 “Whois Accuracy Program Specification” means the Whois Accuracy Program Specification attached hereto, as updated from time to time in accordance with this Agreement.

1.31 “Whois Specification” means the Registration Data Directory Service (Whois) Specification attached hereto, as updated from time to time in accordance with this Agreement.

1.32 “Working Group” means representatives of the Applicable Registrars and other members of the community that the Registrar Stakeholder Group appoints, from time to time, to serve as a working group to consult on amendments to the Applicable Registrar Agreements (excluding bilateral amendments pursuant to Section 6.9).

## **2. ICANN OBLIGATIONS.**

2.1 Accreditation. During the Term of this Agreement and subject to the terms and conditions of this Agreement, Registrar is hereby Accredited by ICANN to act as a registrar (including to insert and renew registration of Registered Names in the Registry Database) for gTLDs.

2.2 Registrar Use of ICANN Name, Website and Trademarks. ICANN hereby grants to Registrar a non-exclusive, worldwide, royalty-free license during the Term of this Agreement (a) to state that it is Accredited by ICANN as a registrar for gTLDs, and (b) to link to pages and documents within the ICANN website. Subject to the terms and conditions set forth in the Logo License Specification attached hereto, ICANN hereby grants to Registrar a non-exclusive, worldwide right and license to use the Trademarks (as defined in the Logo License Specification). No other use of ICANN's name, website or Trademarks is licensed hereby. This license may not be assigned or sublicensed by Registrar to any other party, including, without limitation, any Affiliate of Registrar or any Reseller.

2.3 General Obligations of ICANN. With respect to all matters that impact the rights, obligations, or role of Registrar, ICANN shall during the Term of this Agreement:

2.3.1 exercise its responsibilities in an open and transparent manner;

2.3.2 not unreasonably restrain competition and, to the extent feasible, promote and encourage robust competition;

2.3.3 not apply standards, policies, procedures or practices arbitrarily, unjustifiably, or inequitably and not single out Registrar for disparate treatment unless justified by substantial and reasonable cause; and

2.3.4 ensure, through its reconsideration and independent review policies, adequate appeal procedures for Registrar, to the extent it is adversely affected by ICANN standards, policies, procedures or practices.

2.4 Use of ICANN Accredited Registrars. In order to promote competition in the registration of domain names, and in recognition of the value that ICANN-Accredited registrars bring to the Internet community, ICANN has ordinarily required gTLD registries under contract with ICANN to use ICANN-Accredited registrars, and ICANN will during the course of this agreement abide by any ICANN adopted Specifications or Policies requiring the use of ICANN-Accredited registrars by gTLD registries.

### **3. REGISTRAR OBLIGATIONS.**

3.1 Obligations to Provide Registrar Services. During the Term of this Agreement, Registrar agrees that it will operate as a registrar for one or more gTLDs in accordance with this Agreement.

3.2 Submission of Registered Name Holder Data to Registry. During the Term of this Agreement:

3.2.1 As part of its registration of Registered Names in a gTLD, Registrar shall submit to, or shall place in the Registry Database operated by, the Registry Operator for the gTLD the following data elements:

3.2.1.1 The name of the Registered Name being registered;

3.2.1.2 The IP addresses of the primary nameserver and secondary nameserver(s) for the Registered Name;

3.2.1.3 The corresponding names of those nameservers;

3.2.1.4 Unless automatically generated by the registry system, the identity of the Registrar;

3.2.1.5 Unless automatically generated by the registry system, the expiration date of the registration; and

3.2.1.6 Any other data the Registry Operator requires be submitted to it.

The agreement between the Registry Operator of a gTLD and Registrar may, if approved by ICANN in writing, state alternative required data elements applicable to that gTLD, in which event, the alternative required data elements shall replace and supersede Subsections 3.2.1.1 through 3.2.1.6 stated above for all purposes under this Agreement but only with respect to that particular gTLD. When seeking approval for alternative required data elements, the data elements set forth in Subsections 3.2.1.1 through 3.2.1.6 should be considered suggested minimum requirements.

3.2.2 Within seven (7) days after receiving any updates from the Registered Name Holder to the data elements listed in Subsections 3.2.1.2, 3.1.2.3, and 3.2.1.6 for any Registered Name that Registrar sponsors, Registrar shall submit the updated data elements to, or shall place those elements in the Registry Database operated by, the relevant Registry Operator.

3.2.3 In order to allow reconstitution of the Registry Database in the event of an otherwise unrecoverable technical failure or a change in the designated Registry Operator, within ten (10) days of any such request by ICANN,

Registrar shall submit an electronic database containing the data elements listed in Subsections 3.2.1.1 through 3.2.1.6 for all active records in the registry sponsored by Registrar, in a format specified by ICANN, to the Registry Operator for the appropriate gTLD.

**3.3 Public Access to Data on Registered Names.** During the Term of this Agreement:

3.3.1 At its expense, Registrar shall provide an interactive web page and, with respect to any gTLD operating a “thin” registry, a port 43 Whois service (each accessible via both IPv4 and IPv6) providing free public query-based access to up-to-date (i.e., updated at least daily) data concerning all active Registered Names sponsored by Registrar in any gTLD. Until otherwise specified by a Consensus Policy, such data shall consist of the following elements as contained in Registrar's database:

3.3.1.1 The name of the Registered Name;

3.3.1.2 The names of the primary nameserver and secondary nameserver(s) for the Registered Name;

3.3.1.3 The identity of Registrar (which may be provided through Registrar's website);

3.3.1.4 The original creation date of the registration;

3.3.1.5 The expiration date of the registration;

3.3.1.6 The name and postal address of the Registered Name Holder;

3.3.1.7 The name, postal address, e-mail address, voice telephone number, and (where available) fax number of the technical contact for the Registered Name; and

3.3.1.8 The name, postal address, e-mail address, voice telephone number, and (where available) fax number of the administrative contact for the Registered Name.

The agreement between the Registry Operator of a gTLD and Registrar may, if approved by ICANN in writing, state alternative required data elements applicable to that gTLD, in which event, the alternative required data elements shall replace and supersede Subsections 3.3.1.1 through 3.3.1.8 stated above for all purposes under this Agreement but only with respect to that particular gTLD.

3.3.2 Upon receiving any updates to the data elements listed in Subsections 3.3.1.2, 3.3.1.3, and 3.3.1.5 through 3.3.1.8 from the Registered Name Holder,

Registrar shall promptly update its database used to provide the public access described in Subsection 3.3.1.

3.3.3 Registrar may subcontract its obligation to provide the public access described in Subsection 3.3.1 and the updating described in Subsection 3.3.2, provided that Registrar shall remain fully responsible for the proper provision of the access and updating.

3.3.4 Registrar shall abide by any Consensus Policy that requires registrars to cooperatively implement a distributed capability that provides query-based Whois search functionality across all registrars. If the Whois service implemented by registrars does not in a reasonable time provide reasonably robust, reliable, and convenient access to accurate and up-to-date data, the Registrar shall abide by any Consensus Policy requiring Registrar, if reasonably determined by ICANN to be necessary (considering such possibilities as remedial action by specific registrars), to supply data from Registrar's database to facilitate the development of a centralized Whois database for the purpose of providing comprehensive Registrar Whois search capability.

3.3.5 In providing query-based public access to registration data as required by Subsections 3.3.1 and 3.3.4, Registrar shall not impose terms and conditions on use of the data provided, except as permitted by any Specification or Policy established by ICANN. Unless and until ICANN establishes a different Consensus Policy, Registrar shall permit use of data it provides in response to queries for any lawful purposes except to: (a) allow, enable, or otherwise support the transmission by e-mail, telephone, postal mail, facsimile or other means of mass unsolicited, commercial advertising or solicitations to entities other than the data recipient's own existing customers; or (b) enable high volume, automated, electronic processes that send queries or data to the systems of any Registry Operator or ICANN-Accredited registrar, except as reasonably necessary to register domain names or modify existing registrations.

3.3.6 In the event that ICANN determines, following analysis of economic data by an economist(s) retained by ICANN (which data has been made available to Registrar), that an individual or entity is able to exercise market power with respect to registrations or with respect to registration data used for development of value-added products and services by third parties, Registrar shall provide third-party bulk access to the data subject to public access under Subsection 3.3.1 under the following terms and conditions:

3.3.6.1 Registrar shall make a complete electronic copy of the data available at least one (1) time per week for download by third parties who have entered into a bulk access agreement with Registrar.

3.3.6.2 Registrar may charge an annual fee, not to exceed US\$10,000, for such bulk access to the data.

3.3.6.3 Registrar's access agreement shall require the third party to agree not to use the data to allow, enable, or otherwise support any marketing activities, regardless of the medium used. Such media include but are not limited to e-mail, telephone, facsimile, postal mail, SMS, and wireless alerts.

3.3.6.4 Registrar's access agreement shall require the third party to agree not to use the data to enable high-volume, automated, electronic processes that send queries or data to the systems of any Registry Operator or ICANN-Accredited registrar, except as reasonably necessary to register domain names or modify existing registrations.

3.3.6.5 Registrar's access agreement must require the third party to agree not to sell or redistribute the data except insofar as it has been incorporated by the third party into a value-added product or service that does not permit the extraction of a substantial portion of the bulk data from the value-added product or service for use by other parties.

3.3.7 To comply with applicable statutes and regulations and for other reasons, ICANN may adopt a Consensus Policy establishing limits (a) on the Personal Data concerning Registered Names that Registrar may make available to the public through a public-access service described in this Subsection 3.3 and (b) on the manner in which Registrar may make such data available. Registrar shall comply with any such Consensus Policy.

3.3.8 Registrar shall meet or exceed the requirements set forth in the Whois Specification.

#### 3.4 Retention of Registered Name Holder and Registration Data.

3.4.1 For each Registered Name sponsored by Registrar within a gTLD, Registrar shall collect and securely maintain, in its own electronic database, as updated from time to time:

3.4.1.1 the data specified in the Data Retention Specification attached hereto for the period specified therein;

3.4.1.2 The data elements listed in Subsections 3.3.1.1 through 3.3.1.8;

3.4.1.3 the name and (where available) postal address, e-mail address, voice telephone number, and fax number of the billing contact;

3.4.1.4 any other Registry Data that Registrar has submitted to the Registry Operator or placed in the Registry Database under Subsection 3.2; and

3.4.1.5 the name, postal address, e-mail address, and voice telephone number provided by the customer of any privacy service or licensee of any proxy registration service, in each case, offered or made available by Registrar or its Affiliates in connection with each registration. Effective on the date that ICANN fully implements a Proxy Accreditation Program established in accordance with Section 3.14, the obligations under this Section 3.4.1.5 will cease to apply as to any specific category of data (such as postal address) that is expressly required to be retained by another party in accordance with such Proxy Accreditation Program.

3.4.2 During the Term of this Agreement and for two (2) years thereafter, Registrar (itself or by its agent(s)) shall maintain the following records relating to its dealings with the Registry Operator(s) and Registered Name Holders:

3.4.2.1 In electronic form, the submission date and time, and the content, of all registration data (including updates) submitted in electronic form to the Registry Operator(s);

3.4.2.2 In electronic, paper, or microfilm form, all written communications constituting registration applications, confirmations, modifications, or terminations and related correspondence with Registered Name Holders, including registration contracts; and

3.4.2.3 In electronic form, records of the accounts of all Registered Name Holders with Registrar.

3.4.3 During the Term of this Agreement and for two (2) years thereafter, Registrar shall make the data, information and records specified in this Section 3.4 available for inspection and copying by ICANN upon reasonable notice. In addition, upon reasonable notice and request from ICANN, Registrar shall deliver copies of such data, information and records to ICANN in respect to limited transactions or circumstances that may be the subject of a compliance-related inquiry; provided, however, that such obligation shall not apply to requests for copies of the Registrar's entire database or transaction history. Such copies are to be provided at Registrar's expense. In responding to ICANN's request for delivery of electronic data, information and records, Registrar may submit such information in a format reasonably convenient to Registrar and acceptable to ICANN so as to minimize disruption to the Registrar's business. In the event Registrar believes that the provision of any such data, information or records to ICANN would



violate applicable law or any legal proceedings, ICANN and Registrar agree to discuss in good faith whether appropriate limitations, protections, or alternative solutions can be identified to allow the production of such data, information or records in complete or redacted form, as appropriate. ICANN shall not disclose the content of such data, information or records except as expressly required by applicable law, any legal proceeding or Specification or Policy.

3.4.4 Notwithstanding any other requirement in this Agreement or the Data Retention Specification, Registrar shall not be obligated to maintain records relating to a domain registration beginning on the date two (2) years following the domain registration's deletion or transfer away to a different registrar.

3.5 Rights in Data. Registrar disclaims all rights to exclusive ownership or use of the data elements listed in Subsections 3.2.1.1 through 3.2.1.3 for all Registered Names submitted by Registrar to the Registry Database for, or sponsored by Registrar in, each gTLD for which it is Accredited. Registrar does not disclaim rights in the data elements listed in Subsections 3.2.1.4 through 3.2.1.6 and Subsections 3.3.1.3 through 3.3.1.8 concerning active Registered Names sponsored by it in each gTLD for which it is Accredited, and agrees to grant non-exclusive, irrevocable, royalty-free licenses to make use of and disclose the data elements listed in Subsections 3.2.1.4 through 3.2.1.6 and 3.3.1.3 through 3.3.1.8 for the purpose of providing a service or services (such as a Whois service under Subsection 3.3.4) providing interactive, query-based public access. Upon a change in sponsorship from Registrar of any Registered Name in each gTLD for which it is Accredited, Registrar acknowledges that the registrar gaining sponsorship shall have the rights of an owner to the data elements listed in Subsections 3.2.1.4 through 3.2.1.6 and 3.3.1.3 through 3.3.1.8 concerning that Registered Name, with Registrar also retaining the rights of an owner in that data. Nothing in this Subsection prohibits Registrar from (1) restricting bulk public access to data elements in a manner consistent with this Agreement and any Specifications or Policies or (2) transferring rights it claims in data elements subject to the provisions of this Subsection 3.5.

3.6 Data Escrow. During the Term of this Agreement, on a schedule, under the terms, and in the format specified by ICANN, Registrar shall submit an electronic copy of the data described in Subsections 3.4.1.2 through 3.4.1.5 to ICANN or, at Registrar's election and at its expense, to a reputable escrow agent mutually approved by Registrar and ICANN, such approval also not to be unreasonably withheld by either party. The data shall be held under an agreement among Registrar, ICANN, and the escrow agent (if any) providing that (1) the data shall be received and held in escrow, with no use other than verification that the deposited data is complete, consistent, and in proper format, until released to ICANN; (2) the data shall be released from escrow upon expiration without renewal or termination of this Agreement; and (3) ICANN's rights under the escrow agreement shall be assigned with any assignment of this Agreement. The escrow shall provide that in

the event the escrow is released under this Subsection, ICANN (or its assignee) shall have a non-exclusive, irrevocable, royalty-free license to exercise (only for transitional purposes) or have exercised all rights necessary to provide Registrar Services.

### 3.7 Business Dealings, Including with Registered Name Holders.

3.7.1 In the event ICANN adopts a Specification or Policy that is supported by a consensus of ICANN-Accredited registrars as reflected in the Registrar Stakeholder Group (or any successor group), establishing or approving a Code of Conduct for ICANN-Accredited registrars, Registrar shall abide by that Code of Conduct.

3.7.2 Registrar shall abide by applicable laws and governmental regulations.

3.7.3 Registrar shall not represent to any actual or potential Registered Name Holder that Registrar enjoys access to a registry for which Registrar is Accredited that is superior to that of any other registrar Accredited for that registry.

3.7.4 Registrar shall not activate any Registered Name unless and until it is satisfied that it has received a reasonable assurance of payment of its registration fee. For this purpose, a charge to a credit card, general commercial terms extended to creditworthy customers, or other mechanism providing a similar level of assurance of payment shall be sufficient, provided that the obligation to pay becomes final and non-revocable by the Registered Name Holder upon activation of the registration.

3.7.5 At the conclusion of the registration period, failure by or on behalf of the Registered Name Holder to consent that the registration be renewed within the time specified in a second notice or reminder shall, in the absence of extenuating circumstances, result in cancellation of the registration by the end of the auto-renew grace period (although Registrar may choose to cancel the name earlier).

3.7.5.1 Extenuating circumstances are defined as: UDRP action, valid court order, failure of a Registrar's renewal process (which does not include failure of a registrant to respond), the domain name is used by a nameserver that provides DNS service to third-parties (additional time may be required to migrate the records managed by the nameserver), the registrant is subject to bankruptcy proceedings, payment dispute (where a registrant claims to have paid for a renewal, or a discrepancy in the amount paid), billing dispute (where a registrant disputes the amount on a bill), domain name subject to litigation in a court of competent jurisdiction, or other circumstance as approved specifically by ICANN.

3.7.5.2 Where Registrar chooses, under extenuating circumstances, to renew a domain name without the explicit consent of the registrant, the registrar must maintain a record of the extenuating circumstances associated with renewing that specific domain name for inspection by ICANN consistent with clauses 3.4.2 and 3.4.3 of this registrar accreditation agreement.

3.7.5.3 In the absence of extenuating circumstances (as defined in Section 3.7.5.1 above), a domain name must be deleted within 45 days of either the registrar or the registrant terminating a registration agreement.

3.7.5.4 Registrar shall provide notice to each new registrant describing the details of their deletion and auto-renewal policy including the expected time at which a non-renewed domain name would be deleted relative to the domain's expiration date, or a date range not to exceed ten (10) days in length. If a registrar makes any material changes to its deletion policy during the period of the registration agreement, it must make at least the same effort to inform the registrant of the changes as it would to inform the registrant of other material changes to the registration agreement (as defined in clause 3.7.7 of the registrars accreditation agreement).

3.7.5.5 If Registrar operates a website for domain name registration or renewal, details of Registrar's deletion and auto-renewal policies must be clearly displayed on the website.

3.7.5.6 If Registrar operates a website for domain registration or renewal, it should state, both at the time of registration and in a clear place on its website, any fee charged for the recovery of a domain name during the Redemption Grace Period.

3.7.5.7 In the event that a domain which is the subject of a UDRP dispute is deleted or expires during the course of the dispute, the complainant in the UDRP dispute will have the option to renew or restore the name under the same commercial terms as the registrant. If the complainant renews or restores the name, the name will be placed in Registrar HOLD and Registrar LOCK status, the WHOIS contact information for the registrant will be removed, and the WHOIS entry will indicate that the name is subject to dispute. If the complaint is terminated, or the UDRP dispute finds against the complainant, the name will be deleted within 45 days. The registrant retains the right under the existing redemption grace period provisions to recover the name at any time during the Redemption Grace Period, and retains the right to renew the name before it is deleted.

3.7.6 Registrar shall not insert or renew any Registered Name in any gTLD registry in a manner contrary to (i) any Consensus Policy stating a list or specification of excluded Registered Names that is in effect at the time of insertion or renewal, or (ii) any list of names to be reserved from registration as required by the specific Registry Operator for which the Registrar is providing Registrar Services.

3.7.7 Registrar shall require all Registered Name Holders to enter into an electronic or paper registration agreement with Registrar including at least the provisions set forth in Subsections 3.7.7.1 through 3.7.7.12, and which agreement shall otherwise set forth the terms and conditions applicable to the registration of a domain name sponsored by Registrar. The Registered Name Holder with whom Registrar enters into a registration agreement must be a person or legal entity other than the Registrar, provided that Registrar may be the Registered Name Holder for domains registered for the purpose of conducting its Registrar Services, in which case the Registrar shall submit to the provisions set forth in Subsections 3.7.7.1 through 3.7.7.12 and shall be responsible to ICANN for compliance with all obligations of the Registered Name Holder as set forth in this Agreement and Specifications and Policies. Registrar shall use commercially reasonable efforts to enforce compliance with the provisions of the registration agreement between Registrar and any Registered Name Holder that relate to implementing the requirements of Subsections 3.7.7.1 through 3.7.7.12 or any Consensus Policy.

3.7.7.1 The Registered Name Holder shall provide to Registrar accurate and reliable contact details and correct and update them within seven (7) days of any change during the term of the Registered Name registration, including: the full name, postal address, e-mail address, voice telephone number, and fax number if available of the Registered Name Holder; name of authorized person for contact purposes in the case of an Registered Name Holder that is an organization, association, or corporation; and the data elements listed in Subsections 3.3.1.2, 3.3.1.7 and 3.3.1.8.

3.7.7.2 A Registered Name Holder's willful provision of inaccurate or unreliable information, its willful failure to update information provided to Registrar within seven (7) days of any change, or its failure to respond for over fifteen (15) days to inquiries by Registrar concerning the accuracy of contact details associated with the Registered Name Holder's registration shall constitute a material breach of the Registered Name Holder-registrar contract and be a basis for suspension and/or cancellation of the Registered Name registration.

3.7.7.3 Any Registered Name Holder that intends to license use of a domain name to a third party is nonetheless the Registered Name

Holder of record and is responsible for providing its own full contact information and for providing and updating accurate technical and administrative contact information adequate to facilitate timely resolution of any problems that arise in connection with the Registered Name. A Registered Name Holder licensing use of a Registered Name according to this provision shall accept liability for harm caused by wrongful use of the Registered Name, unless it discloses the current contact information provided by the licensee and the identity of the licensee within seven (7) days to a party providing the Registered Name Holder reasonable evidence of actionable harm.

3.7.7.4 Registrar shall provide notice to each new or renewed Registered Name Holder stating:

3.7.7.4.1 The purposes for which any Personal Data collected from the applicant are intended;

3.7.7.4.2 The intended recipients or categories of recipients of the data (including the Registry Operator and others who will receive the data from Registry Operator);

3.7.7.4.3 Which data are obligatory and which data, if any, are voluntary; and

3.7.7.4.4 How the Registered Name Holder or data subject can access and, if necessary, rectify the data held about them.

3.7.7.5 The Registered Name Holder shall consent to the data processing referred to in Subsection 3.7.7.4.

3.7.7.6 The Registered Name Holder shall represent that notice has been provided equivalent to that described in Subsection 3.7.7.4 to any third-party individuals whose Personal Data are supplied to Registrar by the Registered Name Holder, and that the Registered Name Holder has obtained consent equivalent to that referred to in Subsection 3.7.7.5 of any such third-party individuals.

3.7.7.7 Registrar shall agree that it will not process the Personal Data collected from the Registered Name Holder in a way incompatible with the purposes and other limitations about which it has provided notice to the Registered Name Holder in accordance with Subsection 3.7.7.4 above.

3.7.7.8 Registrar shall agree that it will take reasonable precautions to protect Personal Data from loss, misuse, unauthorized access or disclosure, alteration, or destruction.

3.7.7.9 The Registered Name Holder shall represent that, to the best of the Registered Name Holder's knowledge and belief, neither the registration of the Registered Name nor the manner in which it is directly or indirectly used infringes the legal rights of any third party.

3.7.7.10 For the adjudication of disputes concerning or arising from use of the Registered Name, the Registered Name Holder shall submit, without prejudice to other potentially applicable jurisdictions, to the jurisdiction of the courts (1) of the Registered Name Holder's domicile and (2) where Registrar is located.

3.7.7.11 The Registered Name Holder shall agree that its registration of the Registered Name shall be subject to suspension, cancellation, or transfer pursuant to any Specification or Policy, or pursuant to any registrar or registry procedure not inconsistent with any Specification or Policy, (1) to correct mistakes by Registrar or the Registry Operator in registering the name or (2) for the resolution of disputes concerning the Registered Name.

3.7.7.12 The Registered Name Holder shall indemnify and hold harmless the Registry Operator and its directors, officers, employees, and agents from and against any and all claims, damages, liabilities, costs, and expenses (including reasonable legal fees and expenses) arising out of or related to the Registered Name Holder's domain name registration.

3.7.8 Registrar shall comply with the obligations specified in the Whois Accuracy Program Specification. In addition, notwithstanding anything in the Whois Accuracy Program Specification to the contrary, Registrar shall abide by any Consensus Policy requiring reasonable and commercially practicable (a) verification, at the time of registration, of contact information associated with a Registered Name sponsored by Registrar or (b) periodic re-verification of such information. Registrar shall, upon notification by any person of an inaccuracy in the contact information associated with a Registered Name sponsored by Registrar, take reasonable steps to investigate that claimed inaccuracy. In the event Registrar learns of inaccurate contact information associated with a Registered Name it sponsors, it shall take reasonable steps to correct that inaccuracy.

3.7.9 Registrar shall abide by any Consensus Policy prohibiting or restricting warehousing of or speculation in domain names by registrars.

3.7.10 Registrar shall publish on its website(s) and/or provide a link to the Registrants' Contractual Rights and Responsibilities Specification attached hereto and shall not take any action inconsistent with the corresponding provisions of this Agreement or applicable law.

3.7.11 Registrar shall make available a description of the customer service handling processes available to Registered Name Holders regarding Registrar Services, including a description of the processes for submitting complaints and resolving disputes regarding the Registrar Services.

3.7.12 Nothing in this Agreement prescribes or limits the amount Registrar may charge Registered Name Holders for registration of Registered Names.

3.8 Domain-Name Dispute Resolution. During the Term of this Agreement, Registrar shall have in place a policy and procedures for resolution of disputes concerning Registered Names. Until ICANN adopts an alternative Consensus Policy or other Specification or Policy with respect to the resolution of disputes concerning Registered Names, Registrar shall comply with the Uniform Domain Name Dispute Resolution Policy (“UDRP”) identified on ICANN’s website ([www.icann.org/general/consensus-policies.htm](http://www.icann.org/general/consensus-policies.htm)), as may be modified from time to time. Registrar shall also comply with the Uniform Rapid Suspension (“URS”) procedure or its replacement, as well as with any other applicable dispute resolution procedure as required by a Registry Operator for which Registrar is providing Registrar Services.

3.9 Accreditation Fees. As a condition of Accreditation, Registrar shall pay Accreditation fees to ICANN. These fees consist of yearly and variable fees.

3.9.1 Registrar shall pay ICANN a yearly Accreditation fee in an amount established by the ICANN Board of Directors, in conformity with ICANN’s bylaws and articles of incorporation. This yearly Accreditation fee shall not exceed US\$4,000. Payment of the yearly fee shall be due within thirty (30) days after invoice from ICANN, provided that Registrar may elect to pay the yearly fee in four (4) equal quarterly installments.

3.9.2 Registrar shall pay the variable Accreditation fees established by the ICANN Board of Directors, in conformity with ICANN’s bylaws and articles of incorporation, provided that in each case such fees are reasonably allocated among all registrars that contract with ICANN and that any such fees must be expressly approved by registrars accounting, in the aggregate, for payment of two-thirds of all registrar-level fees. Registrar shall pay such fees in a timely manner for so long as all material terms of this Agreement remain in full force and effect, and notwithstanding the pendency of any dispute between Registrar and ICANN.

3.9.3 For any payments thirty (30) days or more overdue, Registrar shall pay interest on late payments at the rate of 1.5% per month or, if less, the maximum rate permitted by applicable law from later of the date of the invoice or the date the invoice is sent pursuant to Section 7.6 of this Agreement. On reasonable notice given by ICANN to Registrar, accountings submitted by Registrar shall be subject to verification by an audit of

Registrar's books and records by an independent third-party designated by ICANN that shall preserve the confidentiality of such books and records (other than its findings as to the accuracy of, and any necessary corrections to, the accountings).

3.9.4 The Accreditation fees due under this Agreement are exclusive of tax. All taxes, duties, fees and other governmental charges of any kind (including sales, turnover, services, use and value-added taxes) that are imposed by or under the authority of any government or any political subdivision thereof on the Accreditation fees for any services, software and/or hardware shall be borne by Registrar and shall not be considered a part of, a deduction from, or an offset against such Accreditation fees. All payments due to ICANN shall be made without any deduction or withholding on account of any tax, duty, charge, or penalty except as required by applicable law, in which case, the sum payable by Registrar from which such deduction or withholding is to be made shall be increased to the extent necessary to ensure that, after making such deduction or withholding, ICANN receives (free from any liability with respect thereof) a net sum equal to the sum it would have received but for such deduction or withholding being required.

3.10 Insurance. Registrar shall maintain in force commercial general liability insurance or similar liability insurance as specified by ICANN with policy limits of at least US\$500,000 covering liabilities arising from Registrar's registrar business during the Term of this Agreement.

3.11 Obligations of Registrars under common controlling interest. Registrar shall be in breach of this Agreement if:

3.11.1 ICANN terminates an Affiliated Registrar's accreditation agreement with ICANN (an "Affiliate Termination");

3.11.2 Affiliated Registrar has not initiated arbitration challenging ICANN's right to terminate the Affiliated Registrar's accreditation agreement under Section 5.8 of this Agreement, or has initiated such arbitration and has not prevailed;

3.11.3 the Affiliate Termination was the result of misconduct that materially harmed consumers or the public interest;

3.11.4 a second Affiliated Registrar has pursued, after the Affiliate Termination, the same course of conduct that resulted in the Affiliate Termination; and

3.11.5 ICANN has provided Registrar with written notice that it intends to assert the provisions of this Section 3.11 with respect to Registrar, which notice shall identify in reasonable detail the factual basis for such assertion,



and Registrar has failed to cure the impugned conduct within fifteen (15) days of such notice.

**3.12 Obligations Related to Provision of Registrar Services by Third Parties.**

Registrar is responsible for the provision of Registrar Services for all Registered Names that Registrar sponsors being performed in compliance with this Agreement, regardless of whether the Registrar Services are provided by Registrar or a third party, including a Reseller. Registrar must enter into written agreements with all of its Resellers that enable Registrar to comply with and perform all of its obligations under this Agreement. In addition, Registrar must ensure that:

3.12.1 Its Resellers do not display the ICANN or ICANN-Accredited Registrar logo, or otherwise represent themselves as Accredited by ICANN, unless they have written permission from ICANN to do so.

3.12.2 Its Resellers facilitate Registrar's entry into a registration agreement between the Registrar and the Registered Name Holder in accordance with Section 3.7.7, and upon the request of the Registrant, identify Registrar as the sponsoring registrar or provide a means for identifying Registrar as the sponsoring registrar, such as a link to the InterNIC Whois lookup service.

3.12.3 Its Resellers identify the sponsoring registrar upon inquiry from the customer.

3.12.4 Its Resellers comply with any ICANN-adopted Specification or Policy that establishes a program for accreditation of individuals or entities who provide proxy and privacy registration services (a "Proxy Accreditation Program"). Among other features, the Proxy Accreditation Program may require that: (i) proxy and privacy registration services may only be provided in respect of domain name registrations by individuals or entities Accredited by ICANN pursuant to such Proxy Accreditation Program; and (ii) Registrar shall prohibit Resellers from knowingly accepting registrations from any provider of proxy and privacy registration services that is not Accredited by ICANN pursuant the Proxy Accreditation Program. Until such time as the Proxy Accreditation Program is established, Registrar shall require Resellers to comply with the Specification on Privacy and Proxy Registrations attached hereto.

3.12.5 Its Resellers' customers are provided with a link to an ICANN webpage detailing registrant educational information, as detailed in subsection 3.16 below.

3.12.6 In the event Registrar learns that a Reseller is causing Registrar to be in breach of any of the provisions of this Agreement, Registrar shall take reasonable steps to enforce its agreement with such Reseller so as to cure and prevent further instances of non-compliance.

3.12.7 Its Resellers shall publish on their website(s) and/or provide a link to the Registrants' Contractual Rights and Responsibilities Specification attached hereto and shall not take any action inconsistent with the corresponding provisions of this Agreement or applicable law.

Registrar shall use commercially reasonable efforts to enforce compliance with the provisions of the agreement between Registrar and any Reseller that relate to the provisions of Registrar Services.

3.13 Registrar Training. Registrar's primary contact as identified in Subsection 7.6 below or designee (so long as the designee is employed by Registrar or an Affiliated Registrar) shall complete a training course covering registrar obligations under ICANN policies and agreements. The course will be provided by ICANN at no expense to Registrar, and shall be available in an online format.

3.14 Obligations Related to Proxy and Privacy Services. Registrar agrees to comply with any ICANN-adopted Specification or Policy that establishes a Proxy Accreditation Program. Registrar also agrees to reasonably cooperate with ICANN in the development of such program. Until such time as the Proxy Accreditation Program is established, Registrar agrees to comply with the Specification on Privacy and Proxy Registrations attached hereto.

3.15 Registrar Self-Assessment and Audits. Registrar shall complete and deliver to ICANN on a schedule and in the form specified by ICANN from time to time in consultation with registrars a Registrar self-assessment. Registrar shall complete and deliver to ICANN within twenty (20) days following the end of each calendar year, in a form specified by ICANN a certificate executed by the president, chief executive officer, chief financial officer or chief operating officer (or their equivalents) of Registrar certifying compliance with the terms and conditions of this Agreement. ICANN may from time to time (not to exceed twice per calendar year) conduct, or engage a third party to conduct on its behalf, contractual compliance audits to assess compliance by Registrar with the terms and conditions of this Agreement. Any audits pursuant to this Section 3.15 shall be tailored to achieve the purpose of assessing compliance, and ICANN will (a) give reasonable advance notice of any such audit, which notice shall specify in reasonable detail the categories of documents, data and other information requested by ICANN, and (b) use commercially reasonable efforts to conduct such audit in such a manner as to not unreasonably disrupt the operations of Registrar. As part of such audit and upon request by ICANN, Registrar shall timely provide all responsive documents, data and any other information necessary to demonstrate Registrar's compliance with this Agreement. Upon no less than ten (10) days notice (unless otherwise agreed to by Registrar), ICANN may, as part of any contractual compliance audit, conduct site visits during regular business hours to assess compliance by Registrar with the terms and conditions of this Agreement. ICANN shall not disclose Registrar confidential information gathered through such audits except as required by applicable law, legal proceedings, or as expressly permitted by any Specification or

Policy (including ICANN's Documentary Information Disclosure Policy, as such policy may be amended from time to time); provided, however, that, except as required by applicable law or legal proceedings, ICANN shall not release any information that Registrar has marked as, or has otherwise designated in writing to ICANN as, a "confidential trade secret," "confidential commercial information" or "confidential financial information" of Registrar. If any applicable law, legal proceeding or Specification or Policy permits such disclosure, ICANN will provide Registrar no less than fifteen (15) days notice of its intent to disclose such information, unless such notice is prohibited by law or legal proceeding. Such notice shall include to whom and in what manner ICANN plans to disclose such information.

3.16 Link to Registrant Educational Information. ICANN has published an educational webpage summarizing the terms of the Registrar Accreditation Agreement and related Consensus Policies (as of the date of this Agreement, located at: <http://www.icann.org/en/registrars/registrant-rights-responsibilities-en.htm>). Registrar shall provide a link to such webpage on any website it may operate for domain name registration or renewal clearly displayed to its Registered Name Holders at least as clearly as its links to policies or notifications required to be displayed under ICANN Consensus Policies. ICANN may, in consultation with registrars, update the content and/or URL for this website.

3.17 Registrar Contact, Business Organization and Officer Information. Registrar shall provide to ICANN and maintain accurate and current information as specified in the Registrar Information Specification to this Agreement. In addition, Registrar shall publish on each website through which Registrar provides or offers Registrar Services the information specified as requiring such publication in the Registrar Information Specification. Registrar shall notify ICANN within five (5) days of any changes to such information and update Registrar's website(s) within twenty (20) days of any such changes.

3.18 Registrar's Abuse Contact and Duty to Investigate Reports of Abuse.

3.18.1 Registrar shall maintain an abuse contact to receive reports of abuse involving Registered Names sponsored by Registrar, including reports of Illegal Activity. Registrar shall publish an email address to receive such reports on the home page of Registrar's website (or in another standardized place that may be designated by ICANN from time to time). Registrar shall take reasonable and prompt steps to investigate and respond appropriately to any reports of abuse.

3.18.2 Registrar shall establish and maintain a dedicated abuse point of contact, including a dedicated email address and telephone number that is monitored 24 hours a day, seven days a week, to receive reports of Illegal Activity by law enforcement, consumer protection, quasi-governmental or other similar authorities designated from time to time by the national or

territorial government of the jurisdiction in which the Registrar is established or maintains a physical office. Well-founded reports of Illegal Activity submitted to these contacts must be reviewed within 24 hours by an individual who is empowered by Registrar to take necessary and appropriate actions in response to the report. In responding to any such reports, Registrar will not be required to take any action in contravention of applicable law.

3.18.3 Registrar shall publish on its website a description of its procedures for the receipt, handling, and tracking of abuse reports. Registrar shall document its receipt of and response to all such reports. Registrar shall maintain the records related to such reports for the shorter of two (2) years or the longest period permitted by applicable law, and during such period, shall provide such records to ICANN upon reasonable notice.

3.19 Additional Technical Specifications to Implement IPV6, DNNSEC and IDNs. Registrar shall comply with the Additional Registrar Operations Specification attached hereto.

3.20 Notice of Bankruptcy, Convictions and Security Breaches. Registrar will give ICANN notice within seven (7) days of (i) the commencement of any of the proceedings referenced in Section 5.5.8. (ii) the occurrence of any of the matters specified in Section 5.5.2 or Section 5.5.3 or (iii) any unauthorized access to or disclosure of registrant account information or registration data. The notice required pursuant to Subsection (iii) shall include a detailed description of the type of unauthorized access, how it occurred, the number of registrants affected, and any action taken by Registrar in response.

3.21 Obligations of Registrars Affiliated with Registry Operators. In the event Registrar is Affiliated with any Registry Operator or back-end registry operator (an "Affiliated Relationship") during the Term of this Agreement, Registrar shall comply with all ICANN Specifications and Policies that may be developed from time to time with respect to such Affiliated Relationships, and will notify ICANN within thirty (30) days of the occurrence of the event that created the Affiliate relationship (e.g., the closing of any merger, acquisition or other transaction, or the execution of any agreement, in each case, giving rise to such Affiliated Relationship).

3.22 Cooperation with Emergency Registry Service Providers. In the event that ICANN transitions the operation of a registry for a gTLD in which Registrar sponsors Registered Names to an emergency registry service provider, Registrar shall cooperate in all reasonable respects with such emergency registry service provider, including by entering into a registry-registrar agreement with such provider necessary to effect the transition and by providing all Registered Name Holder data reasonably requested by such emergency operator for the purpose of facilitating an efficient transition of the registry for the gTLD.

#### **4. PROCEDURES FOR ESTABLISHMENT OR REVISION OF SPECIFICATIONS AND POLICIES.**

4.1 Compliance with Consensus Policies and Temporary Policies. During the Term of this Agreement, Registrar shall comply with and implement all Consensus Policies and Temporary Policies in existence as of the Effective Date found at <http://www.icann.org/general/consensus-policies.htm>, and as may in the future be developed and adopted in accordance with the ICANN Bylaws, provided such future Consensus Policies and Temporary Policies are adopted in accordance with the procedures and relate to those topics and subject to those limitations set forth in the Consensus Policies and Temporary Policies Specification to this Agreement.

#### **5. TERM, TERMINATION AND DISPUTE RESOLUTION.**

5.1 Term of Agreement. This Agreement shall be effective on the Effective Date and shall have an initial term running until the Expiration Date, unless sooner terminated.

5.2 Renewal. This Agreement and Registrar's Accreditation will be renewed for successive periods of five (5) years upon the Expiration Date and the expiration of each successive five-year term thereafter under the terms and conditions of this Agreement, unless:

5.2.1 at the time of such renewal, Registrar no longer meets the ICANN registrar Accreditation criteria then in effect;

5.2.2 Registrar is not in compliance with its obligations under this Agreement at the time of the Expiration Date or at the expiration of any successive five (5) year term thereafter;

5.2.3 Registrar has been given notice by ICANN of three (3) or more material breaches of this Agreement within the two (2) years preceding the Expiration Date or the date of expiration of any successive five (5) year term thereafter; or

5.2.4 this Agreement has terminated prior to the Expiration Date or the expiration date of any successive five (5) year term thereafter.

In the event Registrar intends to renew this Agreement pursuant to this Section 5.2, Registrar shall provide ICANN written notice thereof during the period that is no more than ninety (90) days and no less than sixty (60) days prior to the Expiration Date and each successive five (5) year term thereafter. The provision of such notice shall not be a condition to renewal hereunder. Pursuant to its customary practices (as may be modified by ICANN), ICANN will provide notice to Registrar of the Expiration Date and the date of expiration of any subsequent term hereunder.

5.3 Right to Substitute Updated Agreement. In the event that, during the Term of this Agreement, ICANN adopts a revised form Registrar accreditation agreement (the “Updated RAA”), Registrar (provided it has not received (i) a notice of breach that it has not cured or (ii) a notice of termination or suspension of this Agreement under this Section 5) may elect, by giving ICANN written notice, to enter into the Updated RAA. In the event of such election, Registrar and ICANN shall as soon as practicable enter into the Updated RAA for the term specified in the Updated RAA, and this Agreement will be deemed terminated.

5.4 Termination of Agreement by Registrar. This Agreement may be terminated before its expiration by Registrar by giving ICANN thirty (30) days written notice. Upon such termination by Registrar, Registrar shall not be entitled to any refund of fees paid to ICANN pursuant to this Agreement.

5.5 Termination of Agreement by ICANN. This Agreement may be terminated before its expiration by ICANN in any of the following circumstances:

5.5.1 There was a material misrepresentation, material inaccuracy, or materially misleading statement in Registrar's application for Accreditation or renewal of Accreditation or any material accompanying the application.

5.5.2 Registrar:

5.5.2.1 is convicted by a court of competent jurisdiction of a felony or other serious offense related to financial activities, or is judged by a court of competent jurisdiction to have:

5.5.2.1.1 committed fraud,

5.5.2.1.2 committed a breach of fiduciary duty, or

5.5.2.1.3 with actual knowledge (or through gross negligence) permitted Illegal Activity in the registration or use of domain names or in the provision to Registrar by any Registered Name Holder of inaccurate Whois information; or

5.5.2.1.4 failed to comply with the terms of an order issued by a court of competent jurisdiction relating to the use of domain names sponsored by the Registrar;

or is the subject of a judicial determination that ICANN reasonably deems as the substantive equivalent of any of the foregoing; or

5.5.2.2 is disciplined by the government of its domicile for conduct involving dishonesty or misuse of funds of others; or

5.5.2.3 is the subject of a non-interlocutory order issued by a court or arbitral tribunal, in each case of competent jurisdiction, finding that Registrar has, directly or through an Affiliate, committed a specific violation(s) of applicable national law or governmental regulation relating to cybersquatting or its equivalent; or

5.5.2.4 is found by ICANN, based on its review of the findings of arbitral tribunals, to have been engaged, either directly or through its Affiliate, in a pattern and practice of trafficking in or use of domain names identical or confusingly similar to a trademark or service mark of a third party in which the Registered Name Holder has no rights or legitimate interest, which trademarks have been registered and are being used in bad faith.

5.5.3 Registrar knowingly employs any officer that is convicted of a misdemeanor related to financial activities or of any felony, or is judged by a court of competent jurisdiction to have committed fraud or breach of fiduciary duty, or is the subject of a judicial determination that ICANN reasonably deems as the substantive equivalent of any of the foregoing and such officer is not terminated within thirty (30) days of Registrar's knowledge of the foregoing; or any member of Registrar's board of directors or similar governing body is convicted of a misdemeanor related to financial activities or of any felony, or is judged by a court of competent jurisdiction to have committed fraud or breach of fiduciary duty, or is the subject of a judicial determination that ICANN reasonably deems as the substantive equivalent of any of the foregoing and such member is not removed from Registrar's board of directors or similar governing body within thirty (30) days of Registrar's knowledge of the foregoing.

5.5.4 Registrar fails to cure any breach of this Agreement within twenty-one (21) days after ICANN gives Registrar notice of the breach.

5.5.5 Registrar fails to comply with a ruling granting specific performance under Sections 5.7 or 7.1.

5.5.6 Registrar has been in fundamental and material breach of its obligations under this Agreement at least three (3) times within a twelve (12) month period.

5.5.7 Registrar continues acting in a manner that ICANN has reasonably determined endangers the stability or operational integrity of the Internet after receiving three (3) days notice of that determination.

5.5.8 (i) Registrar makes an assignment for the benefit of creditors or similar act; (ii) attachment, garnishment or similar proceedings are commenced against Registrar, which proceedings are a material threat to Registrar's ability to provide Registrar Services for gTLDs, and are not

dismissed within sixty (60) days of their commencement; (iii) a trustee, receiver, liquidator or equivalent is appointed in place of Registrar or maintains control over any of Registrar's property; (iv) execution is levied upon any property of Registrar, (v) proceedings are instituted by or against Registrar under any bankruptcy, insolvency, reorganization or other laws relating to the relief of debtors and such proceedings are not dismissed within thirty (30) days of their commencement, or (vi) Registrar files for protection under the United States Bankruptcy Code, 11 U.S.C. Section 101 et seq., or a foreign equivalent or liquidates, dissolves or otherwise discontinues its operations.

**5.6 Termination Procedures.** This Agreement may be terminated in circumstances described in Subsections 5.5.1 through 5.5.6 above only upon fifteen (15) days written notice to Registrar (in the case of Subsection 5.5.4 occurring after Registrar's failure to cure), with Registrar being given an opportunity during that time to initiate arbitration under Subsection 5.8 to determine the appropriateness of termination under this Agreement. This Agreement may be terminated immediately upon notice to Registrar in circumstances described in Subsections 5.5.7 and 5.5.8.

**5.7 Suspension.**

5.7.1 Upon the occurrence of any of the circumstances set forth in Section 5.5, ICANN may, in ICANN's sole discretion, upon delivery of a notice pursuant to Subsection 5.7.2, elect to suspend Registrar's ability to create or sponsor new Registered Names or initiate inbound transfers of Registered Names for any or all gTLDs for a period of up to a twelve (12) months following the effectiveness of such suspension. Suspension of a Registrar does not preclude ICANN's ability to issue a notice of termination in accordance with the notice requirements of Section 5.6.

5.7.2 Any suspension under Subsections 5.7.1 will be effective upon fifteen (15) days written notice to Registrar, with Registrar being given an opportunity during that time to initiate arbitration under Subsection 5.8 to determine the appropriateness of suspension under this Agreement.

5.7.3 Upon suspension, Registrar shall notify users, by posting a prominent notice on its web site, that it is unable to create or sponsor new gTLD domain name registrations or initiate inbound transfers of Registered Names. Registrar's notice shall include a link to the notice of suspension from ICANN.

5.7.4 If Registrar acts in a manner that ICANN reasonably determines endangers the stability or operational integrity of the Internet and upon notice does not immediately cure, ICANN may suspend this Agreement for five (5) working days pending ICANN's application for more extended specific performance or injunctive relief under Subsection 7.1. Suspension



of the Agreement under this Subsection may, at ICANN's sole discretion, preclude the Registrar from (i) providing Registration Services for gTLDs delegated by ICANN on or after the date of delivery of such notice to Registrar and (ii) creating or sponsoring new Registered Names or initiating inbound transfers of Registered Names for any gTLDs. Registrar must also post the statement specified in Subsection 5.7.3.

**5.8 Resolution of Disputes Under this Agreement.** Subject to the limitations set forth in Section 6 and Section 7.4, disputes arising under or in connection with this Agreement, including (1) disputes arising from ICANN's failure to renew Registrar's Accreditation and (2) requests for specific performance, shall be resolved in a court of competent jurisdiction or, at the election of either party, by an arbitration conducted as provided in this Subsection 5.8 pursuant to the International Arbitration Rules of the American Arbitration Association ("AAA"). The arbitration shall be conducted in English and shall occur in Los Angeles County, California, USA. Except as set forth in Section 7.4.5, there shall be one (1) arbitrator agreed by the parties from a list of AAA arbitrators, or if parties do not agree on an arbitrator within fifteen (15) days of the AAA request that the parties designate an arbitrator, the AAA shall choose and appoint an arbitrator, paying due regard to the arbitrator's knowledge of the DNS. The parties shall bear the costs of the arbitration in equal shares, subject to the right of the arbitrator to reallocate the costs in their award as provided in the AAA rules. The parties shall bear their own attorneys' fees in connection with the arbitration, and the arbitrator may not reallocate the attorneys' fees in conjunction with their award. The arbitrator shall render its decision within ninety (90) days of the conclusion of the arbitration hearing. In the event Registrar initiates arbitration to contest the appropriateness of termination of this Agreement by ICANN pursuant to Section 5.5 or suspension of Registrar by ICANN pursuant to Section 5.7.1, Registrar may at the same time request that the arbitration panel stay the termination or suspension until the arbitration decision is rendered. The arbitration panel shall order a stay: (i) upon showing by Registrar that continued operations would not be harmful to consumers or the public interest, or (ii) upon appointment by the arbitration panel of a qualified third party to manage the operations of the Registrar until the arbitration decision is rendered. In furtherance of sub-clause (ii) above, the arbitration panel is hereby granted all necessary authority to appoint a qualified third-party to manage the operations of the Registrar upon the Registrar's request and if the panel deems it appropriate. In selecting the third-party manager, the arbitration panel shall take into consideration, but shall not be bound by, any expressed preferences of Registrar. Any order granting a request for a stay must be issued within fourteen (14) days after the filing of the arbitration. If an order granting a request for a stay is not issued within fourteen (14) days, ICANN has the right to proceed with the termination of this Agreement pursuant to Section 5.5 or suspension of the Registrar pursuant to Section 5.7.1. In the event Registrar initiates arbitration to contest an Independent Review Panel's decision under Subsection 4.3.3 sustaining the ICANN Board of Director's determination that a specification or policy is supported by consensus, Registrar may at the same time request that the arbitration

panel stay the requirement that it comply with the policy until the arbitration decision is rendered, and that request shall have the effect of staying the requirement until the decision or until the arbitration panel has granted an ICANN request for lifting of the stay. In all litigation involving ICANN concerning this Agreement (whether in a case where arbitration has not been elected or to enforce an arbitration award), jurisdiction and exclusive venue for such litigation shall be in a court located in Los Angeles, California, USA; however, the parties shall also have the right to enforce a judgment of such a court in any court of competent jurisdiction. For the purpose of aiding the arbitration and/or preserving the rights of the parties during the pendency of an arbitration, the parties shall have the right to seek temporary or preliminary injunctive relief from the arbitration panel or in a court located in Los Angeles, California, USA, which shall not be a waiver of this arbitration agreement.

5.9 Limitations on Monetary Remedies for Violations of this Agreement. ICANN's aggregate monetary liability for violations of this Agreement shall not exceed an amount equal to the Accreditation fees paid by Registrar to ICANN under Subsection 3.9 of this Agreement during the preceding twelve-month period. Registrar's monetary liability to ICANN for violations of this Agreement shall be limited to Accreditation fees owing to ICANN under this Agreement and, except in the case of a good faith disagreement concerning the interpretation of this agreement, reasonable payment to ICANN for the reasonable and direct costs including attorney fees, staff time, and other related expenses associated with legitimate efforts to enforce Registrar compliance with this agreement and costs incurred by ICANN to respond to or mitigate the negative consequences of such behavior for Registered Name Holders and the Internet community. In the event of repeated willful material breaches of the agreement, Registrar shall be liable for sanctions of up to five (5) times ICANN's enforcement costs, but otherwise in no event shall either party be liable for special, indirect, incidental, punitive, exemplary, or consequential damages for any violation of this Agreement.

## **6. AMENDMENT AND WAIVER.**

6.1 If the ICANN Board of Directors determines that an amendment to this Agreement (including to the Specifications referred to herein, unless such Specifications expressly do not permit amendment thereto) and all other registrar agreements between ICANN and the Applicable Registrars (the "Applicable Registrar Agreements") is desirable (each, a "Special Amendment"), ICANN may adopt a Special Amendment pursuant to the requirements of and process set forth in this Section 6; provided that a Special Amendment may not be a Restricted Amendment.

6.2 Prior to submitting a Special Amendment for Registrar Approval, ICANN shall first consult in good faith with the Working Group regarding the form and substance of such Special Amendment. The duration of such consultation shall be reasonably determined by ICANN based on the substance of the Special Amendment. Following

such consultation, ICANN may propose the adoption of a Special Amendment by publicly posting such amendment on its website for no less than thirty (30) calendar days (the "Posting Period") and providing notice of such proposed amendment to the Applicable Registrars in accordance with Section 7.6. ICANN will consider the public comments submitted on a Special Amendment during the Posting Period (including comments submitted by the Applicable Registrars).

6.3 If, within one hundred eighty (180) calendar days following the expiration of the Posting Period (the "Approval Period"), the ICANN Board of Directors approves a Special Amendment (which may be in a form different than submitted for public comment, but must address the subject matter of the Special Amendment posted for public comment, as modified to reflect and/or address input from the Working Group and public comments), ICANN shall provide notice of, and submit, such Special Amendment for approval or disapproval by the Applicable Registrars. If, during the sixty (60) calendar day period following the date ICANN provides such notice to the Applicable Registrars, such Special Amendment receives Registrar Approval, such Special Amendment shall be deemed approved (an "Approved Amendment") by the Applicable Registrars, and shall be effective and deemed an amendment to this Agreement on the date that is sixty (60) calendar days following the date ICANN provided notice of the approval of such Approved Amendment to Registrar (the "Amendment Effective Date"). In the event that a Special Amendment does not receive Registrar Approval, the Special Amendment shall be deemed not approved by the Applicable Registrars (a "Rejected Amendment"). A Rejected Amendment will have no effect on the terms and conditions of this Agreement, except as set forth below.

6.4 If the ICANN Board of Directors reasonably determines that a Rejected Amendment falls within the subject matter categories set forth in Section 1.2 of the Consensus Policies and Temporary Policies Specification, the ICANN Board of Directors may adopt a resolution (the date such resolution is adopted is referred to herein as the "Resolution Adoption Date") requesting an Issue Report (as such term is defined in ICANN's Bylaws) by the Generic Names Supporting Organization (the "GNSO") regarding the substance of such Rejected Amendment. The policy development process undertaken by the GNSO pursuant to such requested Issue Report is referred to herein as a "PDP." If such PDP results in a Final Report supported by a GNSO Supermajority (as defined in ICANN's Bylaws) that either (i) recommends adoption of the Rejected Amendment as Consensus Policy or (ii) recommends against adoption of the Rejected Amendment as Consensus Policy, and, in the case of (i) above, the Board adopts such Consensus Policy, Registrar shall comply with its obligations pursuant to Section 4 of this Agreement. In either case, ICANN will abandon the Rejected Amendment and it will have no effect on the terms and conditions of this Agreement. Notwithstanding the foregoing provisions of this Section 6.4, the ICANN Board of Directors shall not be required to initiate a PDP with respect to a Rejected Amendment if, at any time in the twelve (12) month period preceding the submission of such Rejected Amendment for Registrar Approval pursuant to Section 6.3, the subject matter of such Rejected Amendment was the

subject of a concluded or otherwise abandoned or terminated PDP that did not result in a GNSO Supermajority recommendation.

6.5 If (i) a Rejected Amendment does not fall within the subject matter categories set forth in Section 1.2 of the Consensus Policies and Temporary Policies Specification, (ii) the subject matter of a Rejected Amendment was, at any time in the twelve (12) month period preceding the submission of such Rejected Amendment for Registrar Approval pursuant to Section 6.3, the subject of a concluded or otherwise abandoned or terminated PDP that did not result in a GNSO Supermajority recommendation, or (iii) a PDP does not result in a Final Report supported by a GNSO Supermajority that either (a) recommends adoption of the Rejected Amendment as Consensus Policy or (b) recommends against adoption of the Rejected Amendment as Consensus Policy (or such PDP has otherwise been abandoned or terminated for any reason), then, in any such case, such Rejected Amendment may still be adopted and become effective in the manner described below. In order for the Rejected Amendment to be adopted, the following requirements must be satisfied:

6.5.1 the subject matter of the Rejected Amendment must be within the scope of ICANN's mission and consistent with a balanced application of its core values (as described in ICANN's Bylaws);

6.5.2 the Rejected Amendment must be justified by a Substantial and Compelling Reason in the Public Interest, must be likely to promote such interest, taking into account competing public and private interests that are likely to be affected by the Rejected Amendment, and must be narrowly tailored and no broader than reasonably necessary to address such Substantial and Compelling Reason in the Public Interest;

6.5.3 to the extent the Rejected Amendment prohibits or requires conduct or activities, imposes material costs on the Applicable Registrars, and/or materially reduces public access to domain name services, the Rejected Amendment must be the least restrictive means reasonably available to address the Substantial and Compelling Reason in the Public Interest;

6.5.4 the ICANN Board of Directors must submit the Rejected Amendment, along with a written explanation of the reasoning related to its determination that the Rejected Amendment meets the requirements set out in subclauses (i) through (iii) above, for public comment for a period of no less than thirty (30) calendar days; and

6.5.5 following such public comment period, the ICANN Board of Directors must (i) engage in consultation (or direct ICANN management to engage in consultation) with the Working Group, subject matter experts, members of the GNSO, relevant advisory committees and other interested stakeholders with respect to such Rejected Amendment for a period of no less than sixty

(60) calendar days; and (ii) following such consultation, reapprove the Rejected Amendment (which may be in a form different than submitted for Registrar Approval, but must address the subject matter of the Rejected Amendment, as modified to reflect and/or address input from the Working Group and public comments) by the affirmative vote of at least two-thirds of the members of the ICANN Board of Directors eligible to vote on such matter, taking into account any ICANN policy affecting such eligibility, including ICANN's Conflict of Interest Policy (a "Board Amendment").

Such Board Amendment shall, subject to Section 6.6, be deemed an Approved Amendment, and shall be effective and deemed an amendment to this Agreement on the date that is sixty (60) calendar days following the date ICANN provided notice of the approval of such Board Amendment to Registrar (which effective date shall be deemed the Amendment Effective Date hereunder). Notwithstanding the foregoing, a Board Amendment may not amend the registrar fees charged by ICANN hereunder, or amend this Section 6.

6.6 Notwithstanding the provisions of Section 6.5, a Board Amendment shall not be deemed an Approved Amendment if, during the thirty (30) calendar day period following the approval by the ICANN Board of Directors of the Board Amendment, the Working Group, on the behalf of the Applicable Registrars, submits to the ICANN Board of Directors an alternative to the Board Amendment (an "Alternative Amendment") that meets the following requirements:

6.6.1 sets forth the precise text proposed by the Working Group to amend this Agreement in lieu of the Board Amendment;

6.6.2 addresses the Substantial and Compelling Reason in the Public Interest identified by the ICANN Board of Directors as the justification for the Board Amendment; and

6.6.3 compared to the Board Amendment is: (a) more narrowly tailored to address such Substantial and Compelling Reason in the Public Interest, and (b) to the extent the Alternative Amendment prohibits or requires conduct or activities, imposes material costs on Affected Registrars, or materially reduces access to domain name services, is a less restrictive means to address the Substantial and Compelling Reason in the Public Interest.

Any proposed amendment that does not meet the requirements of subclauses 6.6.1 through 6.6.3 in the immediately preceding sentence shall not be considered an Alternative Amendment hereunder and therefore shall not supersede or delay the effectiveness of the Board Amendment. If, following the submission of the Alternative Amendment to the ICANN Board of Directors, the Alternative Amendment receives Registrar Approval, the Alternative Amendment shall supersede the Board Amendment and shall be deemed an Approved Amendment hereunder (and shall be effective and deemed an amendment to this Agreement on

the date that is sixty (60) calendar days following the date ICANN provided notice of the approval of such Alternative Amendment to Registrar, which effective date shall be deemed the Amendment Effective Date hereunder), unless, within a period of sixty (60) calendar days following the date that the Working Group notifies the ICANN Board of Directors of Registrar Approval of such Alternative Amendment (during which time ICANN shall engage with the Working Group with respect to the Alternative Amendment), the ICANN Board of Directors by the affirmative vote of at least two-thirds of the members of the ICANN Board of Directors eligible to vote on such matter, taking into account any ICANN policy affecting such eligibility, including ICANN's Conflict of Interest Policy, rejects the Alternative Amendment. If (A) the Alternative Amendment does not receive Registrar Approval within thirty (30) days of submission of such Alternative Amendment to the Applicable Registrars (and the Working Group shall notify ICANN of the date of such submission), or (B) the ICANN Board of Directors rejects the Alternative Amendment by such two-thirds vote, the Board Amendment (and not the Alternative Amendment) shall be effective and deemed an amendment to this Agreement on the date that is sixty (60) calendar days following the date ICANN provided notice to Registrar (which effective date shall be deemed the Amendment Effective Date hereunder). If the ICANN Board of Directors rejects an Alternative Amendment, the board shall publish a written rationale setting forth its analysis of the criteria set forth in Sections 6.6.1 through 6.6.3. The ability of the ICANN Board of Directors to reject an Alternative Amendment hereunder does not relieve the Board of the obligation to ensure that any Board Amendment meets the criteria set forth in Section 6.5.1 through 6.5.5.

6.7 In the event that Registrar believes an Approved Amendment does not meet the substantive requirements set out in this Section 6 or has been adopted in contravention of any of the procedural provisions of this Section 6, Registrar may challenge the adoption of such Special Amendment pursuant to the dispute resolution provisions set forth in Section 5.8, except that such arbitration shall be conducted by a three-person arbitration panel. Any such challenge must be brought within sixty (60) calendar days following the date ICANN provided notice to Registrar of the Approved Amendment, and ICANN may consolidate all challenges brought by registrars (including Registrar) into a single proceeding. The Approved Amendment will be deemed not to have amended this Agreement during the pendency of the dispute resolution process.

6.8 Registrar may apply in writing to ICANN for an exemption from the Approved Amendment (each such request submitted by Registrar hereunder, an "Exemption Request") during the thirty (30) calendar day period following the date ICANN provided notice to Registrar of such Approved Amendment.

6.8.1 Each Exemption Request will set forth the basis for such request and provide detailed support for an exemption from the Approved Amendment. An Exemption Request may also include a detailed description and support for any alternatives to, or a variation of, the Approved Amendment proposed by such Registrar.

6.8.2 An Exemption Request may only be granted upon a clear and convincing showing by Registrar that compliance with the Approved Amendment conflicts with applicable laws or would have a material adverse effect on the long-term financial condition or results of operations of Registrar. No Exemption Request will be granted if ICANN determines, in its reasonable discretion, that granting such Exemption Request would be materially harmful to registrants or result in the denial of a direct benefit to registrants.

6.8.3 Within ninety (90) calendar days of ICANN's receipt of an Exemption Request, ICANN shall either approve (which approval may be conditioned or consist of alternatives to or a variation of the Approved Amendment) or deny the Exemption Request in writing, during which time the Approved Amendment will not amend this Agreement.

6.8.4 If the Exemption Request is approved by ICANN, the Approved Amendment will not amend this Agreement; provided, that any conditions, alternatives or variations of the Approved Amendment required by ICANN shall be effective and, to the extent applicable, will amend this Agreement as of the Amendment Effective Date. If such Exemption Request is denied by ICANN, the Approved Amendment will amend this Agreement as of the Amendment Effective Date (or, if such date has passed, such Approved Amendment shall be deemed effective immediately on the date of such denial), provided that Registrar may, within thirty (30) calendar days following receipt of ICANN's determination, appeal ICANN's decision to deny the Exemption Request pursuant to the dispute resolution procedures set forth in Section 5.8.

6.8.5 The Approved Amendment will be deemed not to have amended this Agreement during the pendency of the dispute resolution process. For avoidance of doubt, only Exemption Requests submitted by Registrar that are approved by ICANN pursuant to this Article 6 or through an arbitration decision pursuant to Section 5.8 shall exempt Registrar from any Approved Amendment, and no Exemption Request granted to any other Applicable Registrar (whether by ICANN or through arbitration), shall have any effect under this Agreement or exempt Registrar from any Approved Amendment.

6.9 Except as set forth in Section 4, Subsection 5.3, this Section 6, Section 7.4 and as otherwise set forth in this Agreement and the Specifications hereto, no amendment, supplement or modification of this Agreement or any provision hereof shall be binding unless executed in writing by both parties, and nothing in this Section 6 or Section 7.4 shall restrict ICANN and Registrar from entering into bilateral amendments and modifications to this Agreement negotiated solely between the two parties. No waiver of any provision of this Agreement shall be binding unless evidenced by a writing signed by the party waiving compliance with such provision. No waiver of any of the provisions of this Agreement or failure to

enforce any of the provisions hereof shall be deemed or shall constitute a waiver of any other provision hereof, nor shall any such waiver constitute a continuing waiver unless otherwise expressly provided. For the avoidance of doubt, nothing in this Section 6 or Section 7.4 shall be deemed to limit Registrar's obligation to comply with Section 4.

6.10 Notwithstanding anything in this Section 6 to the contrary, (a) if Registrar provides evidence to ICANN's reasonable satisfaction that the Approved Amendment would materially increase the cost of providing Registrar Services, then ICANN will allow up to one-hundred eighty (180) calendar days for the Approved Amendment to become effective with respect to Registrar, and (b) no Approved Amendment adopted pursuant to Section 6 shall become effective with respect to Registrar if Registrar provides ICANN with an irrevocable notice of termination pursuant to Section 5.4.

## **7. MISCELLANEOUS PROVISIONS.**

7.1 Specific Performance. While this Agreement is in effect, either party may seek specific performance of any provision of this Agreement in the manner provided in Section 5.8, provided the party seeking such performance is not in material breach of its obligations.

7.2 Handling by ICANN of Registrar-Supplied Data. Before receiving any Personal Data from Registrar, ICANN shall specify to Registrar in writing the purposes for and conditions under which ICANN intends to use the Personal Data. ICANN may from time to time provide Registrar with a revised specification of such purposes and conditions, which specification shall become effective no fewer than thirty (30) days after it is provided to Registrar. ICANN shall not use Personal Data provided by Registrar for a purpose or under conditions inconsistent with the specification in effect when the Personal Data was provided. ICANN shall take reasonable steps to avoid uses of the Personal Data by third parties inconsistent with the specification.

7.3 Assignment; Change of Ownership or Management.

7.3.1 Except as set forth in this Section 7.3.1, either party may assign or transfer this Agreement only with the prior written consent of the other party, which shall not be unreasonably withheld. If ICANN fails to expressly provide or withhold its consent to any requested assignment (an "Assignment Request") of this Agreement by Registrar within thirty (30) calendar days of ICANN's receipt of notice of such Assignment Request (or, if ICANN has requested additional information from Registrar in connection with its review of such request, sixty (60) calendar days of the receipt of all requested written information regarding such request) from Registrar, ICANN shall be deemed to have consented to such requested assignment. Notwithstanding the foregoing, (i) ICANN may assign this Agreement without the consent of Registrar upon approval of the ICANN Board of Directors in conjunction with



a reorganization, reconstitution or re-incorporation of ICANN upon such assignee's express assumption of the terms and conditions of this Agreement, (ii) Registrar may assign this Agreement without the consent of ICANN to a wholly-owned subsidiary of Registrar upon such subsidiary's express assumption of the terms and conditions of this Agreement, and (iii) ICANN shall be deemed to have consented to an Assignment Request in which the assignee associated with such Assignment Request is a party to a Registrar Accreditation Agreement with ICANN on the terms set forth in this Agreement (provided that such assignee is then in compliance with the terms and conditions of such Registrar Accreditation Agreement in all material respects), unless ICANN provides to Registrar a written objection to such Assignment Request within ten (10) calendar days of ICANN's receipt of notice of such Assignment Request pursuant to this Section 7.3.1.

7.3.2 To the extent that an entity acquires a Controlling interest in Registrar's stock, assets or business, Registrar shall provide ICANN notice within seven (7) days of such an acquisition. Such notification shall include a statement that affirms that Registrar meets the Specification or Policy on Accreditation criteria then in effect, and is in compliance with its obligations under this Agreement. Within thirty (30) days of such notification, ICANN may request additional information from the Registrar establishing compliance with this Agreement, in which case Registrar must supply the requested information within fifteen (15) days. Any disputes concerning Registrar's continued Accreditation shall be resolved pursuant to Section 5.8.

#### 7.4 Negotiation Process.

7.4.1 If either the Chief Executive Officer of ICANN ("CEO") or the Chairperson of the Registrar Stakeholder Group ("Chair") desires to discuss any revision(s) to this Agreement, the CEO or Chair, as applicable, shall provide written notice to the other person, which shall set forth in reasonable detail the proposed revisions to this Agreement (a "Negotiation Notice"). Notwithstanding the foregoing, neither the CEO nor the Chair may (i) propose revisions to this Agreement that modify any Consensus Policy then existing, (ii) propose revisions to this Agreement pursuant to this Section 7.4 on or before June 30, 2014, or (iii) propose revisions or submit a Negotiation Notice more than once during any twelve month period beginning on July 1, 2014.

7.4.2 Following receipt of the Negotiation Notice by either the CEO or the Chair, ICANN and the Working Group shall consult in good faith negotiations regarding the form and substance of the proposed revisions to this Agreement, which shall be in the form of a proposed amendment to this Agreement (the "Proposed Revisions"), for a period of at least ninety (90) calendar days (unless a resolution is earlier reached) and attempt to reach a mutually acceptable agreement relating to the Proposed Revisions (the "Discussion Period").

7.4.3 If, following the conclusion of the Discussion Period, an agreement is reached on the Proposed Revisions, ICANN shall post the mutually agreed Proposed Revisions on its website for public comment for no less than thirty (30) calendar days (the "Posting Period") and provide notice of such revisions to all Applicable Registrars in accordance with Section 7.6. ICANN and the Working Group will consider the public comments submitted on the Proposed Revisions during the Posting Period (including comments submitted by the Applicable Registrars). Following the conclusion of the Posting Period, the Proposed Revisions shall be submitted for Registrar Approval and approval by the ICANN Board of Directors. If such approvals are obtained, the Proposed Revisions shall be deemed an Approved Amendment by the Applicable Registrars and ICANN, and shall be effective and deemed an amendment to this Agreement upon sixty (60) calendar days notice from ICANN to Registrar.

7.4.4 If, following the conclusion of the Discussion Period, an agreement is not reached between ICANN and the Working Group on the Proposed Revisions, either the CEO or the Chair may provide the other person written notice (the "Mediation Notice") requiring each party to attempt to resolve the disagreements related to the Proposed Revisions through impartial, facilitative (non-evaluative) mediation in accordance with the terms and conditions set forth below. In the event that a Mediation Notice is provided, ICANN and the Working Group shall, within fifteen (15) calendar days thereof, simultaneously post the text of their desired version of the Proposed Revisions and a position paper with respect thereto on ICANN's website.

7.4.4.1 The mediation shall be conducted by a single mediator selected by the parties. If the parties cannot agree on a mediator within fifteen (15) calendar days following receipt by the CEO or Chair, as applicable, of the Mediation Notice, the parties will promptly select a mutually acceptable mediation provider entity, which entity shall, as soon as practicable following such entity's selection, designate a mediator, who is a licensed attorney with general knowledge of contract law and, to the extent necessary to mediate the particular dispute, general knowledge of the domain name system. Any mediator must confirm in writing that he or she is not, and will not become during the term of the mediation, an employee, partner, executive officer, director, or security holder of ICANN or an Applicable Registrar. If such confirmation is not provided by the appointed mediator, then a replacement mediator shall be appointed pursuant to this Section 7.4.4.1.

7.4.4.2 The mediator shall conduct the mediation in accordance with the rules and procedures for facilitative mediation that he or she determines following consultation with the parties. The parties shall

discuss the dispute in good faith and attempt, with the mediator's assistance, to reach an amicable resolution of the dispute.

7.4.4.3 Each party shall bear its own costs in the mediation. The parties shall share equally the fees and expenses of the mediator.

7.4.4.4 If an agreement is reached during the mediation, ICANN shall post the mutually agreed Proposed Revisions on its website for the Posting Period and provide notice to all Applicable Registrars in accordance with Section 7.6. ICANN and the Working Group will consider the public comments submitted on the agreed Proposed Revisions during the Posting Period (including comments submitted by the Applicable Registrars). Following the conclusion of the Posting Period, the Proposed Revisions shall be submitted for Registrar Approval and approval by the ICANN Board of Directors. If such approvals are obtained, the Proposed Revisions shall be deemed an Approved Amendment by the Applicable Registrars and ICANN, and shall be effective and deemed an amendment to this Agreement upon sixty (60) days notice from ICANN to Registrar.

7.4.4.5 If the parties have not resolved the dispute for any reason by the date that is ninety (90) calendar days following receipt by the CEO or Chair, as applicable, of the Mediation Notice, the mediation shall automatically terminate (unless extended by agreement of the parties). The mediator shall deliver to the parties a definition of the issues that could be considered in future arbitration, if invoked. Those issues are subject to the limitations set forth in Section 7.4.5.2 below.

7.4.5 If, following mediation, ICANN and the Working Group have not reached an agreement on the Proposed Revisions, either the CEO or the Chair may provide the other person written notice (an "Arbitration Notice") requiring ICANN and the Applicable Registry Operators to resolve the dispute through binding arbitration in accordance with the arbitration provisions of Section 5.8, subject to the requirements and limitations of this Section 7.4.5.

7.4.5.1 If an Arbitration Notice is sent, the mediator's definition of issues, along with the Proposed Revisions (be those from ICANN, Registrars or both) shall be posted for public comment on ICANN's website for a period of no less than thirty (30) calendar days. ICANN and the Working Group will consider the public comments submitted on the Proposed Revisions during the Posting Period (including comments submitted by the Applicable Registrars), and information regarding such comments and consideration shall be provided to the a three (3) person arbitrator panel. Each party may modify is Proposed Revisions before and after the Posting Period. The arbitration

proceeding may not commence prior to the closing of such public comment period, and ICANN may consolidate all challenges brought by registrars (including Registrar) into a single proceeding. Except as set forth in this Section 7.4.5.1, the arbitration shall be conducted pursuant to Section 5.8.

7.4.5.2 No dispute regarding the Proposed Revisions may be submitted for arbitration to the extent the subject matter of the Proposed Revisions (i) relates to Consensus Policy, (ii) falls within the subject matter categories set forth in Section 1.2 of the Consensus Policies and Temporary Policies Specification, or (iii) seeks to amend any of the following provisions or Specifications of this Agreement: Sections 2, 4 and 6; subsections 3.1, 3.2, 3.3, 3.4, 3.5, 3.7, 3.8, 3.9, 3.14, 3.19, 3.21, 5.1, 5.2 or 5.3; and the Consensus Policies and Temporary Policies Specification, Data Retention Specification, WHOIS Accuracy Program Specification, Registration Data Directory Service (WHOIS) Specification or the Additional Registrar Operation Specification.

7.4.5.3 The mediator will brief the arbitrator panel regarding ICANN and the Working Group's respective proposals relating to the Proposed Revisions.

7.4.5.4 No amendment to this Agreement relating to the Proposed Revisions may be submitted for arbitration by either the Working Group or ICANN, unless, in the case of the Working Group, the proposed amendment has received Registrar Approval and, in the case of ICANN, the proposed amendment has been approved by the ICANN Board of Directors.

7.4.5.5 In order for the arbitrator panel to approve either ICANN or the Working Group's proposed amendment relating to the Proposed Revisions, the arbitrator panel must conclude that such proposed amendment is consistent with a balanced application of ICANN's core values (as described in ICANN's Bylaws) and reasonable in light of the balancing of the costs and benefits to the business interests of the Applicable Registrars and ICANN (as applicable), and the public benefit sought to be achieved by the Proposed Revisions as set forth in such amendment. If the arbitrator panel concludes that either ICANN or the Working Group's proposed amendment relating to the Proposed Revisions meets the foregoing standard, such amendment shall be effective and deemed an amendment to this Agreement upon sixty (60) calendar days notice from ICANN to Registrar and deemed an Approved Amendment hereunder.

7.4.6 With respect to an Approved Amendment relating to an amendment proposed by ICANN, Registrar may apply in writing to ICANN for an exemption from such amendment pursuant to the provisions of Section 6.8.

7.4.7 Notwithstanding anything in this Section 7.4 to the contrary, (a) if Registrar provides evidence to ICANN's reasonable satisfaction that the Approved Amendment would materially increase the cost of providing Registrar Services, then ICANN will allow up to one-hundred eighty (180) calendar days for the Approved Amendment to become effective with respect to Registrar, and (b) no Approved Amendment adopted pursuant to Section 7.4 shall become effective with respect to Registrar if Registrar provides ICANN with an irrevocable notice of termination pursuant to Section 5.4.

7.5 No Third-Party Beneficiaries. This Agreement shall not be construed to create any obligation by either ICANN or Registrar to any non-party to this Agreement, including any Registered Name Holder.

7.6 Notices and Designations. Except as provided in Section 4.4 and Section 6, all notices to be given under this Agreement shall be given in writing at the address of the appropriate party as set forth below, unless that party has given a notice of change of address in writing. Each party shall notify the other party within thirty (30) days of any change to its contact information. Any written notice required by this Agreement shall be deemed to have been properly given when delivered in person, when sent by electronic facsimile with receipt of confirmation of delivery, when scheduled for delivery by internationally recognized courier service, or when delivered by electronic means followed by an affirmative confirmation of receipt by the recipient's facsimile machine or email server. For any notice of a new Specification or Policy established in accordance with this Agreement, Registrar shall be afforded a reasonable period of time after notice of the establishment of such Specification or Policy is e-mailed to Registrar and posted on the ICANN website in which to comply with that specification, policy or program, taking into account any urgency involved. Notices and designations by ICANN under this Agreement shall be effective when written notice of them is deemed given to Registrar.

If to ICANN, addressed to:

Internet Corporation for Assigned Names and Numbers  
12025 Waterfront Drive, Suite 300  
Los Angeles, California 90094-2536 USA  
Attention: Registrar Accreditation Notices  
Telephone: 1/310/823-9358  
Facsimile: 1/310/823-8649

If to Registrar, addressed to:

[Registrar Name]  
[Courier Address]  
[Mailing Address]  
Attention: [contact person]  
Registrar Website URL: [URL]  
Telephone: [telephone number]  
Facsimile: [fax number]  
e-mail: [e-mail address]

7.7 Dates and Times. All dates and times relevant to this Agreement or its performance shall be computed based on the date and time observed in Los Angeles, California, USA.

7.8 Language. All notices, designations, and Specifications or Policies made under this Agreement shall be in the English language.

7.9 Counterparts. This Agreement may be executed in one or more counterparts, each of which shall be deemed an original, but all of which together shall constitute one and the same instrument.

7.10 Entire Agreement. Except to the extent (a) expressly provided in a written agreement executed by both parties concurrently herewith or (b) of written assurances provided by Registrar to ICANN in connection with its Accreditation, this Agreement (including the specifications, which form part of it) constitutes the entire agreement of the parties pertaining to the Accreditation of Registrar and supersedes all prior agreements, understandings, negotiations and discussions, whether oral or written, between the parties on that subject.

7.11 Severability. If one or more provisions of this Agreement are held to be unenforceable under applicable law, the parties agree to renegotiate such provision in good faith. In the event that the parties cannot reach a mutually agreeable and enforceable replacement for such provision, then (a) such provision shall be excluded from this Agreement; (b) the balance of this Agreement shall be interpreted as if such provision were so excluded; and (c) the balance of this Agreement shall be enforceable in accordance with its terms.

[signature page follows]

IN WITNESS WHEREOF, the parties hereto have caused this Agreement to be executed in duplicate by their duly authorized representatives.

**ICANN**

**[Registrar]**

By: \_\_\_\_\_

By: \_\_\_\_\_

Name: \_\_\_\_\_

Name: \_\_\_\_\_

Title: \_\_\_\_\_

Title: \_\_\_\_\_

# Registrar Accreditation Agreement

---

This REGISTRAR ACCREDITATION AGREEMENT (this "Agreement") is by and between the Internet Corporation for Assigned Names and Numbers, a California non-profit, public benefit corporation ("ICANN"), and [Registrar Name], a [Organization type and jurisdiction] ("Registrar"), and shall be deemed made on \_\_\_\_\_, at Los Angeles, California, USA.

**1. DEFINITIONS.** For purposes of this Agreement, the following definitions shall apply:

1.1 "Account Holder" means the person or entity that is paying for the Registered Name or otherwise controls the management of the registered name, when that person or entity is not the Registered Name Holder.

~~1.1~~1.2 "Accredited" or "Accreditation" means to identify and set minimum standards for the performance of registration functions, to recognize persons or entities meeting those standards, and to enter into an accreditation agreement that sets forth the rules and procedures applicable to the provision of Registrar Services.

~~1.2~~1.3 "Affiliate" means a person or entity that, directly or indirectly, through one or more intermediaries, Controls, is controlled by, or is under common control with, the person or entity specified.

~~1.3~~1.4 "Affiliated Registrar" is another Accredited registrar that is an Affiliate of Registrar.

1.5 "Applicable Registrar Family" means, with respect to Affiliated Registrars, such Affiliated Registrar as a group.

~~1.4~~1.6 "Consensus Policy" has the meaning set forth in the Consensus Policies and Temporary Policies Specification attached hereto.

~~1.5~~1.7 "Control" (including the terms "controlled by" and "under common control with") means the possession, directly or indirectly, of the power to direct or cause the direction of the management or policies of a person or entity, whether through the ownership of securities, as trustee or executor, by serving as an employee or a



member of a board of directors or equivalent governing body, by contract, by credit arrangement or otherwise.

~~1.6~~1.8 "DNS" refers to the Internet domain-name system.

~~1.7~~1.9 The "Effective Date" is \_\_\_\_\_.

~~1.8~~1.10 The "Expiration Date" is \_\_\_\_\_.

~~1.9~~1.11 "gTLD" or "gTLDs" refers to the top-level domain(s) of the DNS delegated by ICANN pursuant to a registry agreement that is in full force and effect, other than any country code TLD (ccTLD) or internationalized domain name (IDN) country code TLD.

~~1.10~~1.12 "gTLD Zone-File Data" means all data contained in a DNS zone file for the registry, or for any subdomain for which Registry Services are provided and that contains Registered Names, as provided to nameservers on the Internet.

~~1.11~~1.13 "Illegal Activity" means conduct involving use of a Registered Name sponsored by Registrar that is prohibited by applicable law and/or exploitation of Registrar's domain name resolution or registration services in furtherance of conduct involving the use of a Registered Name sponsored by Registrar that is prohibited by applicable law.

~~1.12~~1.14 "Personal Data" refers to data about any identified or identifiable natural person.

~~1.13~~1.15 "Registered Name" refers to a domain name within the domain of a gTLD, whether consisting of two (2) or more (e.g., john.smith.name) levels, about which a gTLD Registry Operator (or an Affiliate or subcontractor thereof engaged in providing Registry Services) maintains data in a Registry Database, arranges for such maintenance, or derives revenue from such maintenance. A name in a Registry Database may be a Registered Name even though it does not appear in a zone file (e.g., a registered but inactive name).

~~1.14~~1.16 "Registered Name Holder" means the holder of a Registered Name.

~~1.15~~1.17 The word "registrar," when appearing without an initial capital letter, refers to a person or entity that contracts with Registered Name Holders and with a Registry Operator and collects registration data about the Registered Name Holders and submits registration information for entry in the Registry Database.

1.18 "Registrar Approval" means the receipt of either of the following approvals:

1.18.1 The affirmative approval of Applicable Registrars accounting for 90% of the Total Registered Names Under Management by the Applicable Registrars; provided that, for purposes of calculating the Total Registered

Names Under Management by Applicable Registrars, the Total Registered Names Under Management by each Applicable Registrar Family shall not exceed the Total Registered Names Under Management of the Applicable Registrar Family that is the fifth largest Applicable Registrar Family (measured by number of Registered Names Under Management), both for purposes of the numerator and the denominator; or

1.18.2 The affirmative approval of 50% plus one of the Applicable Registrars that participate in the process to approve or disapprove (i.e. vote for or against, but not abstain or otherwise fail to vote) a proposed amendment under Section 6, and the affirmative approval of Applicable Registrars accounting for 66.67% of the Total Registered Names Under Management by all Applicable Registrars; provided that, for purposes of calculating the Total Registered Names Under Management by Applicable Registrars, the Total Registered Names Under Management by each Applicable Registrar Family shall not exceed the total Registered Names Under Management of the Applicable Registrar Family that is the fifth largest Applicable Registrar Family (measured by number of Registered Names Under Management), both for purposes of the numerator and the denominator. An example of these calculations is set forth in Appendix 1 attached hereto.

~~1.16~~1.19 "Registrar Services" means the services subject to this Agreement provided by a registrar in connection with a gTLD, and includes contracting with Registered Name Holders, collecting registration data about the Registered Name Holders, and submitting registration information for entry in the Registry Database.

~~1.17~~1.20 "Registry Data" means all Registry Database data maintained in electronic form, and shall include gTLD Zone-File Data, all data used to provide Registry Services and submitted by registrars in electronic form, and all other data used to provide Registry Services concerning particular domain name registrations or nameservers maintained in electronic form in a Registry Database.

~~1.18~~1.21 "Registry Database" means a database comprised of data about one or more DNS domain names within the domain of a registry that is used to generate either DNS resource records that are published authoritatively or responses to domain-name availability lookup requests or Whois queries, for some or all of those names.

~~1.19~~1.22 A "Registry Operator" is the person or entity then responsible, in accordance with an agreement between ICANN (or its assignee) and that person or entity (those persons or entities) or, if that agreement is terminated or expires, in accordance with an agreement between the US Government and that person or entity (those persons or entities), for providing Registry Services for a specific gTLD.

~~1.20~~1.23 "Registry Services," with respect to a particular gTLD, shall have the meaning defined in the agreement between ICANN and the Registry Operator for that gTLD.

~~1.21~~ A Registered Name is "sponsored" by the registrar that placed the record associated with that registration into the registry. Sponsorship of a registration may be changed at the express direction of the Registered Name Holder or, in the event a registrar loses Accreditation, in accordance with then-current ICANN Specifications and Policies.

~~1.22~~1.24 A "Reseller" is a person or entity that participates in Registrar's distribution channel for domain name registrations (a) pursuant to an agreement, arrangement or understanding with Registrar or (b) with Registrar's actual knowledge, provides some or all Registrar Services, including collecting registration data about Registered Name Holders, submitting that data to Registrar, or facilitating the entry of the registration agreement between the Registrar and the Registered Name Holder.

1.25 "Restricted Amendment" means (i) an amendment of the Consensus Policies and Temporary Policies Specification or (ii) the term of this Agreement as specified in Section 5.1, as such term may be extended pursuant to Section 5.2.

1.26 A Registered Name is "sponsored" by the registrar that placed the record associated with that registration into the registry. Sponsorship of a registration may be changed at the express direction of the Registered Name Holder or, in the event a registrar loses Accreditation, in accordance with then-current ICANN Specifications and Policies.

~~1.23~~1.27 "Specifications and/or Policies" include Consensus Policies, Specifications (such as the Whois Accuracy Program Specification) referenced in this Agreement, and any amendments, policies, procedures, or programs specifically contemplated by this Agreement or authorized by ICANN's Bylaws.

~~1.24~~1.28 "Term of this Agreement" begins on the Effective Date and continues to the earlier of (a) the Expiration Date, or (b) termination of this Agreement.

1.29 "Total Registered Names Under Management" means the total number of Registered Names sponsored by all Applicable Registrars as reflected in the latest monthly reports submitted to ICANN by Registrars.

~~1.25~~1.30 "Whois Accuracy Program Specification" means the Whois Accuracy Program Specification attached hereto, as updated from time to time in accordance with this Agreement.

~~1.26~~1.31 "Whois Specification" means the Registration Data Directory Service (Whois) Specification attached hereto, as updated from time to time in accordance with this Agreement.

1.32 “Working Group” means representatives of the Applicable Registrars and other members of the community that the Registrar Stakeholder Group appoints, from time to time, to serve as a working group to consult on amendments to the Applicable Registrar Agreements (excluding bilateral amendments pursuant to Section 6.9).

## **2. ICANN OBLIGATIONS.**

2.1 Accreditation. During the Term of this Agreement and subject to the terms and conditions of this Agreement, Registrar is hereby Accredited by ICANN to act as a registrar (including to insert and renew registration of Registered Names in the Registry Database) for gTLDs.

2.2 Registrar Use of ICANN Name, Website and Trademarks. ICANN hereby grants to Registrar a non-exclusive, worldwide, royalty-free license during the Term of this Agreement (a) to state that it is Accredited by ICANN as a registrar for gTLDs, and (b) to link to pages and documents within the ICANN website. Subject to the terms and conditions set forth in the Logo License Specification attached hereto, ICANN hereby grants to Registrar a non-exclusive, worldwide right and license to use the Trademarks (as defined in the Logo License Specification). No other use of ICANN's name, website or Trademarks is licensed hereby. This license may not be assigned or sublicensed by Registrar to any other party, including, without limitation, any Affiliate of Registrar or any Reseller.

2.3 General Obligations of ICANN. With respect to all matters that impact the rights, obligations, or role of Registrar, ICANN shall during the Term of this Agreement:

2.3.1 exercise its responsibilities in an open and transparent manner;

2.3.2 not unreasonably restrain competition and, to the extent feasible, promote and encourage robust competition;

2.3.3 not apply standards, policies, procedures or practices arbitrarily, unjustifiably, or inequitably and not single out Registrar for disparate treatment unless justified by substantial and reasonable cause; and

2.3.4 ensure, through its reconsideration and independent review policies, adequate appeal procedures for Registrar, to the extent it is adversely affected by ICANN standards, policies, procedures or practices.

2.4 Use of ICANN Accredited Registrars. In order to promote competition in the registration of domain names, and in recognition of the value that ICANN-Accredited registrars bring to the Internet community, ICANN has ordinarily required gTLD registries under contract with ICANN to use ICANN-Accredited registrars, and ICANN will during the course of this agreement abide by any ICANN adopted

Specifications or Policies requiring the use of ICANN-Accredited registrars by gTLD registries.

### **3. REGISTRAR OBLIGATIONS.**

3.1 Obligations to Provide Registrar Services. During the Term of this Agreement, Registrar agrees that it will operate as a registrar for one or more gTLDs in accordance with this Agreement.

3.2 Submission of Registered Name Holder Data to Registry. During the Term of this Agreement:

3.2.1 As part of its registration of Registered Names in a gTLD, Registrar shall submit to, or shall place in the Registry Database operated by, the Registry Operator for the gTLD the following data elements:

3.2.1.1 The name of the Registered Name being registered;

3.2.1.2 The IP addresses of the primary nameserver and secondary nameserver(s) for the Registered Name;

3.2.1.3 The corresponding names of those nameservers;

3.2.1.4 Unless automatically generated by the registry system, the identity of the Registrar;

3.2.1.5 Unless automatically generated by the registry system, the expiration date of the registration; and

3.2.1.6 Any other data the Registry Operator requires be submitted to it.

The agreement between the Registry Operator of a gTLD and Registrar may, if approved by ICANN in writing, state alternative required data elements applicable to that gTLD, in which event, the alternative required data elements shall replace and supersede Subsections 3.2.1.1 through 3.2.1.6 stated above for all purposes under this Agreement but only with respect to that particular gTLD. [When seeking approval for alternative required data elements, the data elements set forth in Subsections 3.2.1.1 through 3.2.1.6 should be considered suggested minimum requirements.](#)

3.2.2 Within seven (7) days after receiving any updates from the Registered Name Holder to the data elements listed in Subsections 3.2.1.2, 3.1.2.3, and 3.2.1.6 for any Registered Name that Registrar sponsors, Registrar shall submit the updated data elements to, or shall place those elements in the Registry Database operated by, the relevant Registry Operator.

3.2.3 In order to allow reconstitution of the Registry Database in the event of an otherwise unrecoverable technical failure or a change in the designated Registry Operator, within ten (10) days of any such request by ICANN, Registrar shall submit an electronic database containing the data elements listed in Subsections 3.2.1.1 through 3.2.1.6 for all active records in the registry sponsored by Registrar, in a format specified by ICANN, to the Registry Operator for the appropriate gTLD.

3.3 Public Access to Data on Registered Names. During the Term of this Agreement:

3.3.1 At its expense, Registrar shall provide an interactive web page and, with respect to any gTLD operating a “thin” registry, a port 43 Whois service (each accessible via both IPv4 and IPv6) providing free public query-based access to up-to-date (i.e., updated at least daily) data concerning all active Registered Names sponsored by Registrar in any gTLD. Until otherwise specified by a Consensus Policy, such data shall consist of the following elements as contained in Registrar's database:

3.3.1.1 The name of the Registered Name;

3.3.1.2 The names of the primary nameserver and secondary nameserver(s) for the Registered Name;

3.3.1.3 The identity of Registrar (which may be provided through Registrar's website);

3.3.1.4 The original creation date of the registration;

3.3.1.5 The expiration date of the registration;

3.3.1.6 The name and postal address of the Registered Name Holder;

3.3.1.7 The name, postal address, e-mail address, voice telephone number, and (where available) fax number of the technical contact for the Registered Name; and

3.3.1.8 The name, postal address, e-mail address, voice telephone number, and (where available) fax number of the administrative contact for the Registered Name.

The agreement between the Registry Operator of a gTLD and Registrar may, if approved by ICANN in writing, state alternative required data elements applicable to that gTLD, in which event, the alternative required data elements shall replace and supersede Subsections 3.3.1.1 through 3.3.1.8 stated above for all purposes under this Agreement but only with respect to that particular gTLD.

3.3.2 Upon receiving any updates to the data elements listed in Subsections 3.3.1.2, 3.3.1.3, and 3.3.1.5 through 3.3.1.8 from the Registered Name Holder, Registrar shall promptly update its database used to provide the public access described in Subsection 3.3.1.

3.3.3 Registrar may subcontract its obligation to provide the public access described in Subsection 3.3.1 and the updating described in Subsection 3.3.2, provided that Registrar shall remain fully responsible for the proper provision of the access and updating.

3.3.4 Registrar shall abide by any Consensus Policy that requires registrars to cooperatively implement a distributed capability that provides query-based Whois search functionality across all registrars. If the Whois service implemented by registrars does not in a reasonable time provide reasonably robust, reliable, and convenient access to accurate and up-to-date data, the Registrar shall abide by any Consensus Policy requiring Registrar, if reasonably determined by ICANN to be necessary (considering such possibilities as remedial action by specific registrars), to supply data from Registrar's database to facilitate the development of a centralized Whois database for the purpose of providing comprehensive Registrar Whois search capability.

3.3.5 In providing query-based public access to registration data as required by Subsections 3.3.1 and 3.3.4, Registrar shall not impose terms and conditions on use of the data provided, except as permitted by any Specification or Policy established by ICANN. Unless and until ICANN establishes a different Consensus Policy, Registrar shall permit use of data it provides in response to queries for any lawful purposes except to: (a) allow, enable, or otherwise support the transmission by e-mail, telephone, postal mail, facsimile or other means of mass unsolicited, commercial advertising or solicitations to entities other than the data recipient's own existing customers; or (b) enable high volume, automated, electronic processes that send queries or data to the systems of any Registry Operator or ICANN-Accredited registrar, except as reasonably necessary to register domain names or modify existing registrations.

3.3.6 In the event that ICANN determines, following analysis of economic data by an economist(s) retained by ICANN (which data has been made available to Registrar), that an individual or entity is able to exercise market power with respect to registrations or with respect to registration data used for development of value-added products and services by third parties, Registrar shall provide third-party bulk access to the data subject to public access under Subsection 3.3.1 under the following terms and conditions:

3.3.6.1 Registrar shall make a complete electronic copy of the data available at least one (1) time per week for download by third parties who have entered into a bulk access agreement with Registrar.

3.3.6.2 Registrar may charge an annual fee, not to exceed US\$10,000, for such bulk access to the data.

3.3.6.3 Registrar's access agreement shall require the third party to agree not to use the data to allow, enable, or otherwise support any marketing activities, regardless of the medium used. Such media include but are not limited to e-mail, telephone, facsimile, postal mail, SMS, and wireless alerts.

3.3.6.4 Registrar's access agreement shall require the third party to agree not to use the data to enable high-volume, automated, electronic processes that send queries or data to the systems of any Registry Operator or ICANN-Accredited registrar, except as reasonably necessary to register domain names or modify existing registrations.

3.3.6.5 Registrar's access agreement must require the third party to agree not to sell or redistribute the data except insofar as it has been incorporated by the third party into a value-added product or service that does not permit the extraction of a substantial portion of the bulk data from the value-added product or service for use by other parties.

3.3.7 To comply with applicable statutes and regulations and for other reasons, ICANN may adopt a Consensus Policy establishing limits (a) on the Personal Data concerning Registered Names that Registrar may make available to the public through a public-access service described in this Subsection 3.3 and (b) on the manner in which Registrar may make such data available. Registrar shall comply with any such Consensus Policy.

3.3.8 Registrar shall meet or exceed the requirements set forth in the Whois Specification.

#### 3.4 Retention of Registered Name Holder and Registration Data.

3.4.1 For each Registered Name sponsored by Registrar within a gTLD, Registrar shall collect and securely maintain, in its own electronic database, as updated from time to time:

3.4.1.1 the data specified in the Data Retention Specification attached hereto for the period specified therein;

3.4.1.2 The data elements listed in Subsections 3.3.1.1 through 3.3.1.8;



3.4.1.3 the name and (where available) postal address, e-mail address, voice telephone number, and fax number of the billing contact;

3.4.1.4 any other Registry Data that Registrar has submitted to the Registry Operator or placed in the Registry Database under Subsection 3.2; and

3.4.1.5 the name, postal address, e-mail address, and voice telephone number provided by the customer of any privacy service or licensee of any proxy registration service, in each case, offered or made available by Registrar or its Affiliates in connection with each registration. Effective on the date that ICANN fully implements a Proxy Accreditation Program established in accordance with Section 3.14, the obligations under this Section 3.4.1.5 will cease to apply as to any specific category of data (such as postal address) that is expressly required to be retained by another party in accordance with such Proxy Accreditation Program.

3.4.2 During the Term of this Agreement and for two (2) years thereafter, Registrar (itself or by its agent(s)) shall maintain the following records relating to its dealings with the Registry Operator(s) and Registered Name Holders:

3.4.2.1 In electronic form, the submission date and time, and the content, of all registration data (including updates) submitted in electronic form to the Registry Operator(s);

3.4.2.2 In electronic, paper, or microfilm form, all written communications constituting registration applications, confirmations, modifications, or terminations and related correspondence with Registered Name Holders, including registration contracts; and

3.4.2.3 In electronic form, records of the accounts of all Registered Name Holders with Registrar.

3.4.3 During the Term of this Agreement and for two (2) years thereafter, Registrar shall make the data, information and records specified in this Section 3.4 available for inspection and copying by ICANN upon reasonable notice. In addition, upon reasonable notice and request from ICANN, Registrar shall deliver copies of such data, information and records to ICANN in respect to limited transactions or circumstances that may be the subject of a compliance-related inquiry; provided, however, that such obligation shall not apply to requests for copies of the Registrar's entire database or transaction history. Such copies are to be provided at Registrar's expense. In responding to ICANN's request for delivery of electronic data, information and records, Registrar may submit such information in a format reasonably

convenient to Registrar and acceptable to ICANN so as to minimize disruption to the Registrar's business. In the event Registrar believes that the provision of any such data, information or records to ICANN would violate applicable law or any legal proceedings, ICANN and Registrar agree to discuss in good faith whether appropriate limitations, protections, or alternative solutions can be identified to allow the production of such data, information or records in complete or redacted form, as appropriate. ICANN shall not disclose the content of such data, information or records except as expressly required by applicable law, any legal proceeding or Specification or Policy.

3.4.4 Notwithstanding any other requirement in this Agreement or the Data Retention Specification, Registrar shall not be obligated to maintain records relating to a domain registration beginning on the date two (2) years following the domain registration's deletion or transfer away to a different registrar.

3.5 Rights in Data. Registrar disclaims all rights to exclusive ownership or use of the data elements listed in Subsections 3.2.1.1 through 3.2.1.3 for all Registered Names submitted by Registrar to the Registry Database for, or sponsored by Registrar in, each gTLD for which it is Accredited. Registrar does not disclaim rights in the data elements listed in Subsections 3.2.1.4 through 3.2.1.6 and Subsections 3.3.1.3 through 3.3.1.8 concerning active Registered Names sponsored by it in each gTLD for which it is Accredited, and agrees to grant non-exclusive, irrevocable, royalty-free licenses to make use of and disclose the data elements listed in Subsections 3.2.1.4 through 3.2.1.6 and 3.3.1.3 through 3.3.1.8 for the purpose of providing a service or services (such as a Whois service under Subsection 3.3.4) providing interactive, query-based public access. Upon a change in sponsorship from Registrar of any Registered Name in each gTLD for which it is Accredited, Registrar acknowledges that the registrar gaining sponsorship shall have the rights of an owner to the data elements listed in Subsections 3.2.1.4 through 3.2.1.6 and 3.3.1.3 through 3.3.1.8 concerning that Registered Name, with Registrar also retaining the rights of an owner in that data. Nothing in this Subsection prohibits Registrar from (1) restricting bulk public access to data elements in a manner consistent with this Agreement and any Specifications or Policies or (2) transferring rights it claims in data elements subject to the provisions of this Subsection 3.5.

3.6 Data Escrow. During the Term of this Agreement, on a schedule, under the terms, and in the format specified by ICANN, Registrar shall submit an electronic copy of the data described in Subsections 3.4.1.2 through 3.4.1.5 to ICANN or, at Registrar's election and at its expense, to a reputable escrow agent mutually approved by Registrar and ICANN, such approval also not to be unreasonably withheld by either party. The data shall be held under an agreement among Registrar, ICANN, and the escrow agent (if any) providing that (1) the data shall be received and held in escrow, with no use other than verification that the deposited data is complete, consistent, and in proper format, until released to ICANN; (2) the

data shall be released from escrow upon expiration without renewal or termination of this Agreement; and (3) ICANN's rights under the escrow agreement shall be assigned with any assignment of this Agreement. The escrow shall provide that in the event the escrow is released under this Subsection, ICANN (or its assignee) shall have a non-exclusive, irrevocable, royalty-free license to exercise (only for transitional purposes) or have exercised all rights necessary to provide Registrar Services.

### 3.7 Business Dealings, Including with Registered Name Holders.

3.7.1 In the event ICANN adopts a Specification or Policy that is supported by a consensus of ICANN-Accredited registrars as reflected in the Registrar Stakeholder Group (or any successor group), establishing or approving a Code of Conduct for ICANN-Accredited registrars, Registrar shall abide by that Code of Conduct.

3.7.2 Registrar shall abide by applicable laws and governmental regulations.

3.7.3 Registrar shall not represent to any actual or potential Registered Name Holder that Registrar enjoys access to a registry for which Registrar is Accredited that is superior to that of any other registrar Accredited for that registry.

3.7.4 Registrar shall not activate any Registered Name unless and until it is satisfied that it has received a reasonable assurance of payment of its registration fee. For this purpose, a charge to a credit card, general commercial terms extended to creditworthy customers, or other mechanism providing a similar level of assurance of payment shall be sufficient, provided that the obligation to pay becomes final and non-revocable by the Registered Name Holder upon activation of the registration.

3.7.5 At the conclusion of the registration period, failure by or on behalf of the Registered Name Holder to consent that the registration be renewed within the time specified in a second notice or reminder shall, in the absence of extenuating circumstances, result in cancellation of the registration by the end of the auto-renew grace period (although Registrar may choose to cancel the name earlier).

3.7.5.1 Extenuating circumstances are defined as: UDRP action, valid court order, failure of a Registrar's renewal process (which does not include failure of a registrant to respond), the domain name is used by a nameserver that provides DNS service to third-parties (additional time may be required to migrate the records managed by the nameserver), the registrant is subject to bankruptcy proceedings, payment dispute (where a registrant claims to have paid for a renewal, or a discrepancy in the amount paid), billing dispute (where a

registrant disputes the amount on a bill), domain name subject to litigation in a court of competent jurisdiction, or other circumstance as approved specifically by ICANN.

3.7.5.2 Where Registrar chooses, under extenuating circumstances, to renew a domain name without the explicit consent of the registrant, the registrar must maintain a record of the extenuating circumstances associated with renewing that specific domain name for inspection by ICANN consistent with clauses 3.4.2 and 3.4.3 of this registrar accreditation agreement.

3.7.5.3 In the absence of extenuating circumstances (as defined in Section 3.7.5.1 above), a domain name must be deleted within 45 days of either the registrar or the registrant terminating a registration agreement.

3.7.5.4 Registrar shall provide notice to each new registrant describing the details of their deletion and auto-renewal policy including the expected time at which a non-renewed domain name would be deleted relative to the domain's expiration date, or a date range not to exceed ten (10) days in length. If a registrar makes any material changes to its deletion policy during the period of the registration agreement, it must make at least the same effort to inform the registrant of the changes as it would to inform the registrant of other material changes to the registration agreement (as defined in clause 3.7.7 of the registrars accreditation agreement).

3.7.5.5 If Registrar operates a website for domain name registration or renewal, details of Registrar's deletion and auto-renewal policies must be clearly displayed on the website.

3.7.5.6 If Registrar operates a website for domain registration or renewal, it should state, both at the time of registration and in a clear place on its website, any fee charged for the recovery of a domain name during the Redemption Grace Period.

3.7.5.7 In the event that a domain which is the subject of a UDRP dispute is deleted or expires during the course of the dispute, the complainant in the UDRP dispute will have the option to renew or restore the name under the same commercial terms as the registrant. If the complainant renews or restores the name, the name will be placed in Registrar HOLD and Registrar LOCK status, the WHOIS contact information for the registrant will be removed, and the WHOIS entry will indicate that the name is subject to dispute. If the complaint is terminated, or the UDRP dispute finds against the complainant, the name will be deleted within 45 days. The registrant

retains the right under the existing redemption grace period provisions to recover the name at any time during the Redemption Grace Period, and retains the right to renew the name before it is deleted.

3.7.6 Registrar shall not insert or renew any Registered Name in any gTLD registry in a manner contrary to (i) any Consensus Policy stating a list or specification of excluded Registered Names that is in effect at the time of insertion or renewal, or (ii) any list of names to be reserved from registration as required by the specific Registry Operator for which the Registrar is providing Registrar Services.

3.7.7 Registrar shall require all Registered Name Holders to enter into an electronic or paper registration agreement with Registrar including at least the provisions set forth in Subsections 3.7.7.1 through 3.7.7.12, and which agreement shall otherwise set forth the terms and conditions applicable to the registration of a domain name sponsored by Registrar. The Registered Name Holder with whom Registrar enters into a registration agreement must be a person or legal entity other than the Registrar, provided that Registrar may be the Registered Name Holder for domains registered for the purpose of conducting its Registrar Services, in which case the Registrar shall submit to the provisions set forth in Subsections 3.7.7.1 through 3.7.7.12 and shall be responsible to ICANN for compliance with all obligations of the Registered Name Holder as set forth in this Agreement and Specifications and Policies. Registrar shall use commercially reasonable efforts to enforce compliance with the provisions of the registration agreement between Registrar and any Registered Name Holder that relate to implementing the requirements of Subsections 3.7.7.1 through 3.7.7.12 or any Consensus Policy.

3.7.7.1 The Registered Name Holder shall provide to Registrar accurate and reliable contact details and correct and update them within seven (7) days of any change during the term of the Registered Name registration, including: the full name, postal address, e-mail address, voice telephone number, and fax number if available of the Registered Name Holder; name of authorized person for contact purposes in the case of an Registered Name Holder that is an organization, association, or corporation; and the data elements listed in Subsections 3.3.1.2, 3.3.1.7 and 3.3.1.8.

3.7.7.2 A Registered Name Holder's willful provision of inaccurate or unreliable information, its willful failure to update information provided to Registrar within seven (7) days of any change, or its failure to respond for over fifteen (15) days to inquiries by Registrar concerning the accuracy of contact details associated with the Registered Name Holder's registration shall constitute a material breach of the Registered Name Holder-registrar contract and be a

basis for suspension and/or cancellation of the Registered Name registration.

3.7.7.3 Any Registered Name Holder that intends to license use of a domain name to a third party is nonetheless the Registered Name Holder of record and is responsible for providing its own full contact information and for providing and updating accurate technical and administrative contact information adequate to facilitate timely resolution of any problems that arise in connection with the Registered Name. A Registered Name Holder licensing use of a Registered Name according to this provision shall accept liability for harm caused by wrongful use of the Registered Name, unless it discloses the current contact information provided by the licensee and the identity of the licensee within seven (7) days to a party providing the Registered Name Holder reasonable evidence of actionable harm.

3.7.7.4 Registrar shall provide notice to each new or renewed Registered Name Holder stating:

3.7.7.4.1 The purposes for which any Personal Data collected from the applicant are intended;

3.7.7.4.2 The intended recipients or categories of recipients of the data (including the Registry Operator and others who will receive the data from Registry Operator);

3.7.7.4.3 Which data are obligatory and which data, if any, are voluntary; and

3.7.7.4.4 How the Registered Name Holder or data subject can access and, if necessary, rectify the data held about them.

3.7.7.5 The Registered Name Holder shall consent to the data processing referred to in Subsection 3.7.7.4.

3.7.7.6 The Registered Name Holder shall represent that notice has been provided equivalent to that described in Subsection 3.7.7.4 to any third-party individuals whose Personal Data are supplied to Registrar by the Registered Name Holder, and that the Registered Name Holder has obtained consent equivalent to that referred to in Subsection 3.7.7.5 of any such third-party individuals.

3.7.7.7 Registrar shall agree that it will not process the Personal Data collected from the Registered Name Holder in a way incompatible with the purposes and other limitations about which it has provided

notice to the Registered Name Holder in accordance with Subsection 3.7.7.4 above.

3.7.7.8 Registrar shall agree that it will take reasonable precautions to protect Personal Data from loss, misuse, unauthorized access or disclosure, alteration, or destruction.

3.7.7.9 The Registered Name Holder shall represent that, to the best of the Registered Name Holder's knowledge and belief, neither the registration of the Registered Name nor the manner in which it is directly or indirectly used infringes the legal rights of any third party.

3.7.7.10 For the adjudication of disputes concerning or arising from use of the Registered Name, the Registered Name Holder shall submit, without prejudice to other potentially applicable jurisdictions, to the jurisdiction of the courts (1) of the Registered Name Holder's domicile and (2) where Registrar is located.

3.7.7.11 The Registered Name Holder shall agree that its registration of the Registered Name shall be subject to suspension, cancellation, or transfer pursuant to any Specification or Policy, or pursuant to any registrar or registry procedure not inconsistent with any Specification or Policy, (1) to correct mistakes by Registrar or the Registry Operator in registering the name or (2) for the resolution of disputes concerning the Registered Name.

3.7.7.12 The Registered Name Holder shall indemnify and hold harmless the Registry Operator and its directors, officers, employees, and agents from and against any and all claims, damages, liabilities, costs, and expenses (including reasonable legal fees and expenses) arising out of or related to the Registered Name Holder's domain name registration.

3.7.8 Registrar shall comply with the obligations specified in the Whois Accuracy Program Specification. In addition, notwithstanding anything in the Whois Accuracy Program Specification to the contrary, Registrar shall abide by any Consensus Policy requiring reasonable and commercially practicable (a) verification, at the time of registration, of contact information associated with a Registered Name sponsored by Registrar or (b) periodic re-verification of such information. Registrar shall, upon notification by any person of an inaccuracy in the contact information associated with a Registered Name sponsored by Registrar, take reasonable steps to investigate that claimed inaccuracy. In the event Registrar learns of inaccurate contact information associated with a Registered Name it sponsors, it shall take reasonable steps to correct that inaccuracy.

3.7.9 Registrar shall abide by any Consensus Policy prohibiting or restricting warehousing of or speculation in domain names by registrars.

3.7.10 Registrar shall publish on its website(s) and/or provide a link to the Registrants' [Contractual](#) Rights and Responsibilities Specification attached hereto and shall not take any action inconsistent with the corresponding provisions of this Agreement or applicable law.

3.7.11 Registrar shall make available a description of the customer service handling processes available to Registered Name Holders regarding Registrar Services, including a description of the processes for submitting complaints and resolving disputes regarding the Registrar Services.

3.7.12 Nothing in this Agreement prescribes or limits the amount Registrar may charge Registered Name Holders for registration of Registered Names.

3.8 Domain-Name Dispute Resolution. During the Term of this Agreement, Registrar shall have in place a policy and procedures for resolution of disputes concerning Registered Names. Until ICANN adopts an alternative Consensus Policy or other Specification or Policy with respect to the resolution of disputes concerning Registered Names, Registrar shall comply with the Uniform Domain Name Dispute Resolution Policy ("UDRP") identified on ICANN's website ([www.icann.org/general/consensus-policies.htm](http://www.icann.org/general/consensus-policies.htm)), as may be modified from time to time. Registrar shall also comply with the Uniform Rapid Suspension ("URS") procedure or its replacement, as well as with any other applicable dispute resolution procedure as required by a Registry Operator for which Registrar is providing Registrar Services.

3.9 Accreditation Fees. As a condition of Accreditation, Registrar shall pay Accreditation fees to ICANN. These fees consist of yearly and variable fees.

3.9.1 Registrar shall pay ICANN a yearly Accreditation fee in an amount established by the ICANN Board of Directors, in conformity with ICANN's bylaws and articles of incorporation. This yearly Accreditation fee shall not exceed US\$4,000. Payment of the yearly fee shall be due within thirty (30) days after invoice from ICANN, provided that Registrar may elect to pay the yearly fee in four (4) equal quarterly installments.

3.9.2 Registrar shall pay the variable Accreditation fees established by the ICANN Board of Directors, in conformity with ICANN's bylaws and articles of incorporation, provided that in each case such fees are reasonably allocated among all registrars that contract with ICANN and that any such fees must be expressly approved by registrars accounting, in the aggregate, for payment of two-thirds of all registrar-level fees. Registrar shall pay such fees in a timely manner for so long as all material terms of this Agreement remain in full force and effect, and notwithstanding the pendency of any dispute between Registrar and ICANN.



3.9.3 For any payments thirty (30) days or more overdue, Registrar shall pay interest on late payments at the rate of 1.5% per month or, if less, the maximum rate permitted by applicable law from later of the date of the invoice or the date the invoice is sent pursuant to Section 7.6 of this Agreement. On reasonable notice given by ICANN to Registrar, accountings submitted by Registrar shall be subject to verification by an audit of Registrar's books and records by an independent third-party designated by ICANN that shall preserve the confidentiality of such books and records (other than its findings as to the accuracy of, and any necessary corrections to, the accountings).

3.9.4 The Accreditation fees due under this Agreement are exclusive of tax. All taxes, duties, fees and other governmental charges of any kind (including sales, turnover, services, use and value-added taxes) that are imposed by or under the authority of any government or any political subdivision thereof on the Accreditation fees for any services, software and/or hardware shall be borne by Registrar and shall not be considered a part of, a deduction from, or an offset against such Accreditation fees. All payments due to ICANN shall be made without any deduction or withholding on account of any tax, duty, charge, or penalty except as required by applicable law, in which case, the sum payable by Registrar from which such deduction or withholding is to be made shall be increased to the extent necessary to ensure that, after making such deduction or withholding, ICANN receives (free from any liability with respect thereof) a net sum equal to the sum it would have received but for such deduction or withholding being required.

3.10 Insurance. Registrar shall maintain in force commercial general liability insurance or similar liability insurance as specified by ICANN with policy limits of at least US\$500,000 covering liabilities arising from Registrar's registrar business during the Term of this Agreement.

3.11 Obligations of Registrars under common controlling interest. Registrar shall be in breach of this Agreement if:

3.11.1 ICANN terminates an Affiliated Registrar's accreditation agreement with ICANN (an "Affiliate Termination");

3.11.2 Affiliated Registrar has not initiated arbitration challenging ICANN's right to terminate the Affiliated Registrar's accreditation agreement under Section 5.8 of this Agreement, or has initiated such arbitration and has not prevailed;

3.11.3 the Affiliate Termination was the result of misconduct that materially harmed consumers or the public interest;

3.11.4 a second Affiliated Registrar has pursued, after the Affiliate Termination, the same course of conduct that resulted in the Affiliate Termination; and

3.11.5 ICANN has provided Registrar with written notice that it intends to assert the provisions of this Section 3.11 with respect to Registrar, which notice shall identify in reasonable detail the factual basis for such assertion, and Registrar has failed to cure the impugned conduct within fifteen (15) days of such notice.

3.12 Obligations Related to Provision of Registrar Services by Third Parties.

Registrar is responsible for the provision of Registrar Services for all Registered Names that Registrar sponsors being performed in compliance with this Agreement, regardless of whether the Registrar Services are provided by Registrar or a third party, including a Reseller. Registrar must enter into written agreements with all of its Resellers that enable Registrar to comply with and perform all of its obligations under this Agreement. In addition, Registrar must ensure that:

3.12.1 Its Resellers do not display the ICANN or ICANN-Accredited Registrar logo, or otherwise represent themselves as Accredited by ICANN, unless they have written permission from ICANN to do so.

3.12.2 Its Resellers facilitate Registrar's entry into a registration agreement between the Registrar and the Registered Name Holder in accordance with Section 3.7.7, and upon the request of the Registrant, identify Registrar as the sponsoring registrar or provide a means for identifying Registrar as the sponsoring registrar, such as a link to the InterNIC Whois lookup service.

3.12.3 Its Resellers identify the sponsoring registrar upon inquiry from the customer.

3.12.4 Its Resellers comply with any ICANN-adopted Specification or Policy that establishes a program for accreditation of individuals or entities who provide proxy and privacy registration services (a "Proxy Accreditation Program"). Among other features, the Proxy Accreditation Program may require that: (i) proxy and privacy registration services may only be provided in respect of domain name registrations by individuals or entities Accredited by ICANN pursuant to such Proxy Accreditation Program; and (ii) Registrar shall prohibit Resellers from knowingly accepting registrations from any provider of proxy and privacy registration services that is not Accredited by ICANN pursuant the Proxy Accreditation Program. Until such time as the Proxy Accreditation Program is established, Registrar shall require Resellers to comply with the Specification on Privacy and Proxy Registrations attached hereto.

3.12.5 Its Resellers' customers are provided with a link to an ICANN webpage detailing registrant educational information, as detailed in subsection 3.16 below.

3.12.6 In the event Registrar learns that a Reseller is causing Registrar to be in breach of any of the provisions of this Agreement, Registrar shall take reasonable steps to enforce its agreement with such Reseller so as to cure and prevent further instances of non-compliance.

3.12.7 Its Resellers shall publish on their website(s) and/or provide a link to the Registrants' [Contractual](#) Rights and Responsibilities Specification attached hereto and shall not take any action inconsistent with the corresponding provisions of this Agreement or applicable law.

Registrar shall use commercially reasonable efforts to enforce compliance with the provisions of the agreement between Registrar and any Reseller that relate to the provisions of Registrar Services.

3.13 Registrar Training. Registrar's primary contact as identified in Subsection 7.6 below or designee (so long as the designee is employed by Registrar or an Affiliated Registrar) shall complete a training course covering registrar obligations under ICANN policies and agreements. The course will be provided by ICANN at no expense to Registrar, and shall be available in an online format.

3.14 Obligations Related to Proxy and Privacy Services. Registrar agrees to comply with any ICANN-adopted Specification or Policy that establishes a Proxy Accreditation Program. Registrar also agrees to reasonably cooperate with ICANN in the development of such program. Until such time as the Proxy Accreditation Program is established, Registrar agrees to comply with the Specification on Privacy and Proxy Registrations attached hereto.

3.15 Registrar Self-Assessment and Audits. Registrar shall complete and deliver to ICANN on a schedule and in the form specified by ICANN from time to time in consultation with registrars a Registrar self-assessment. Registrar shall complete and deliver to ICANN within twenty (20) days following the end of each calendar year, in a form specified by ICANN a certificate executed by the president, chief executive officer, chief financial officer or chief operating officer (or their equivalents) of Registrar certifying compliance with the terms and conditions of this Agreement. ICANN may from time to time (not to exceed twice per calendar year) conduct, or engage a third party to conduct on its behalf, contractual compliance audits to assess compliance by Registrar with the terms and conditions of this Agreement. Any audits pursuant to this Section 3.15 shall be tailored to achieve the purpose of assessing compliance, and ICANN will (a) give reasonable advance notice of any such audit, which notice shall specify in reasonable detail the categories of documents, data and other information requested by ICANN, and (b) use commercially reasonable efforts to conduct such audit in such a manner as to not

unreasonably disrupt the operations of Registrar. As part of such audit and upon request by ICANN, Registrar shall timely provide all responsive documents, data and any other information necessary to demonstrate Registrar's compliance with this Agreement. Upon no less than ten (10) days notice (unless otherwise agreed to by Registrar), ICANN may, as part of any contractual compliance audit, conduct site visits during regular business hours to assess compliance by Registrar with the terms and conditions of this Agreement. ICANN shall not disclose Registrar confidential information gathered through such audits except as required by applicable law, legal proceedings, or as expressly permitted by any Specification or Policy (including ICANN's Documentary Information Disclosure Policy, as such policy may be amended from time to time); provided, however, that, except as required by applicable law or legal proceedings, ICANN shall not release any information that Registrar has marked as, or has otherwise designated in writing to ICANN as, a "confidential trade secret," "confidential commercial information" or "confidential financial information" of Registrar. If any applicable law, legal proceeding or Specification or Policy permits such disclosure, ICANN will provide Registrar no less than fifteen (15) days notice of its intent to disclose such information, unless such notice is prohibited by law or legal proceeding. Such notice shall include to whom and in what manner ICANN plans to disclose such information.

3.16 Link to Registrant Educational Information. ICANN has published an educational webpage summarizing the terms of the Registrar Accreditation Agreement and related Consensus Policies (as of the date of this Agreement, located at: <http://www.icann.org/en/registrars/registrant-rights-responsibilities-en.htm>). Registrar shall provide a link to such webpage on any website it may operate for domain name registration or renewal clearly displayed to its Registered Name Holders at least as clearly as its links to policies or notifications required to be displayed under ICANN Consensus Policies. ICANN may, in consultation with registrars, update the content and/or URL for this website.

3.17 Registrar Contact, Business Organization and Officer Information. Registrar shall provide to ICANN and maintain accurate and current information as specified in the Registrar Information Specification to this Agreement. In addition, Registrar shall publish on each website through which Registrar provides or offers Registrar Services the information specified as requiring such publication in the Registrar Information Specification. Registrar shall notify ICANN within five (5) days of any changes to such information and update Registrar's website(s) within twenty (20) days of any such changes.

3.18 Registrar's Abuse Contact and Duty to Investigate Reports of Abuse.

3.18.1 Registrar shall maintain an abuse contact to receive reports of abuse involving Registered Names sponsored by Registrar, including reports of Illegal Activity. Registrar shall publish an email address to receive such reports on the home page of Registrar's website (or in another standardized

place that may be designated by ICANN from time to time). Registrar shall take reasonable and prompt steps to investigate and respond appropriately to any reports of abuse.

3.18.2 Registrar shall establish and maintain a dedicated abuse point of contact, including a dedicated email address and telephone number that is monitored 24 hours a day, seven days a week, to receive reports of Illegal Activity by law enforcement, consumer protection, quasi-governmental or other similar authorities designated from time to time by the national or territorial government of the jurisdiction in which the Registrar is established or maintains a physical office. Well-founded reports of Illegal Activity submitted to these contacts must be reviewed within 24 hours by an individual who is empowered by Registrar to take necessary and appropriate actions in response to the report. In responding to any such reports, Registrar will not be required to take any action in contravention of applicable law.

3.18.3 Registrar shall publish on its website a description of its procedures for the receipt, handling, and tracking of abuse reports. Registrar shall document its receipt of and response to all such reports. Registrar shall maintain the records related to such reports for the shorter of two (2) years or the longest period permitted by applicable law, and during such period, shall provide such records to ICANN upon reasonable notice.

3.19 Additional Technical Specifications to Implement IPV6, DNNSEC and IDNs. Registrar shall comply with the Additional Registrar Operations Specification attached hereto.

3.20 Notice of Bankruptcy, Convictions and Security Breaches. Registrar will give ICANN notice within seven (7) days of (i) the commencement of any of the proceedings referenced in Section 5.5.8. (ii) the occurrence of any of the matters specified in Section 5.5.2 or Section 5.5.3 or (iii) any unauthorized access to or disclosure of registrant account information or registration data. The notice required pursuant to Subsection (iii) shall include a detailed description of the type of unauthorized access, how it occurred, the number of registrants affected, and any action taken by Registrar in response.

3.21 Obligations of Registrars Affiliated with Registry Operators. In the event Registrar is Affiliated with any Registry Operator or back-end registry operator (an "Affiliated Relationship") during the Term of this Agreement, Registrar shall comply with all ICANN Specifications and Policies that may be developed from time to time with respect to such Affiliated Relationships, and will notify ICANN within thirty (30) days of the occurrence of the event that created the Affiliate relationship (e.g., the closing of any merger, acquisition or other transaction, or the execution of any agreement, in each case, giving rise to such Affiliated Relationship).

3.22 Cooperation with Emergency Registry Service Providers. In the event that ICANN transitions the operation of a registry for a gTLD in which Registrar sponsors Registered Names to an emergency registry service provider, Registrar shall cooperate in all reasonable respects with such emergency registry service provider, including by entering into a registry-registrar agreement with such provider necessary to effect the transition and by providing all Registered Name Holder data reasonably requested by such emergency operator for the purpose of facilitating an efficient transition of the registry for the gTLD.

#### **4. PROCEDURES FOR ESTABLISHMENT OR REVISION OF SPECIFICATIONS AND POLICIES.**

4.1 Compliance with Consensus Policies and Temporary Policies. During the Term of this Agreement, Registrar shall comply with and implement all Consensus Policies and Temporary Policies in existence as of the Effective Date found at <http://www.icann.org/general/consensus-policies.htm>, and as may in the future be developed and adopted in accordance with the ICANN Bylaws, provided such future Consensus Policies and Temporary Policies are adopted in accordance with the procedures and relate to those topics and subject to those limitations set forth in the Consensus Policies and Temporary Policies Specification to this Agreement.

#### **5. TERM, TERMINATION AND DISPUTE RESOLUTION.**

5.1 Term of Agreement. This Agreement shall be effective on the Effective Date and shall have an initial term running until the Expiration Date, unless sooner terminated.

5.2 Renewal. This Agreement and Registrar's Accreditation will be renewed for successive periods of five (5) years upon the Expiration Date and the expiration of each successive five-year term thereafter under the terms and conditions of this Agreement, unless:

5.2.1 at the time of such renewal, Registrar no longer meets the ICANN registrar Accreditation criteria then in effect;

5.2.2 Registrar is not in compliance with its obligations under this Agreement at the time of the Expiration Date or at the expiration of any successive five (5) year term thereafter;

5.2.3 Registrar has been given notice by ICANN of three (3) or more material breaches of this Agreement within the two (2) years preceding the Expiration Date or the date of expiration of any successive five (5) year term thereafter; or

5.2.4 this Agreement has terminated prior to the Expiration Date or the expiration date of any successive five (5) year term thereafter.

In the event Registrar intends to renew this Agreement pursuant to this Section 5.2, Registrar shall provide ICANN written notice thereof during the period that is no more than ninety (90) days and no less than sixty (60) days prior to the Expiration Date and each successive five (5) year term thereafter. The provision of such notice shall not be a condition to renewal hereunder. Pursuant to its customary practices (as may be modified by ICANN), ICANN will provide notice to Registrar of the Expiration Date and the date of expiration of any subsequent term hereunder.

5.3 Right to Substitute Updated Agreement. In the event that, during the Term of this Agreement, ICANN adopts a revised form Registrar accreditation agreement (the "Updated RAA"), Registrar (provided it has not received (i) a notice of breach that it has not cured or (ii) a notice of termination or suspension of this Agreement under this Section 5) may elect, by giving ICANN written notice, to enter into the Updated RAA. In the event of such election, Registrar and ICANN shall as soon as practicable enter into the Updated RAA for the term specified in the Updated RAA, and this Agreement will be deemed terminated.

5.4 Termination of Agreement by Registrar. This Agreement may be terminated before its expiration by Registrar by giving ICANN thirty (30) days written notice. Upon such termination by Registrar, Registrar shall not be entitled to any refund of fees paid to ICANN pursuant to this Agreement.

5.5 Termination of Agreement by ICANN. This Agreement may be terminated before its expiration by ICANN in any of the following circumstances:

5.5.1 There was a material misrepresentation, material inaccuracy, or materially misleading statement in Registrar's application for Accreditation or renewal of Accreditation or any material accompanying the application.

5.5.2 Registrar:

5.5.2.1 is convicted by a court of competent jurisdiction of a felony or other serious offense related to financial activities, or is judged by a court of competent jurisdiction to have:

5.5.2.1.1 committed fraud,

5.5.2.1.2 committed a breach of fiduciary duty, or

5.5.2.1.3 with actual knowledge (or through gross negligence) permitted Illegal Activity in the registration or use of domain names or in the provision to Registrar by any Registered Name Holder of inaccurate Whois information; or

5.5.2.1.4 failed to comply with the terms of an order issued by a court of competent jurisdiction relating to the use of domain names sponsored by the Registrar;

or is the subject of a judicial determination that ICANN reasonably deems as the substantive equivalent of any of the foregoing; or

5.5.2.2 is disciplined by the government of its domicile for conduct involving dishonesty or misuse of funds of others; or

5.5.2.3 is the subject of a non-interlocutory order issued by a court or arbitral tribunal, in each case of competent jurisdiction, finding that Registrar has, directly or through an Affiliate, committed a specific violation(s) of applicable national law or governmental regulation relating to cybersquatting or its equivalent; or

5.5.2.4 is found by ICANN, based on its review of the findings of arbitral tribunals, to have been engaged, either directly or through its Affiliate, in a pattern and practice of trafficking in or use of domain names identical or confusingly similar to a trademark or service mark of a third party in which the Registered Name Holder has no rights or legitimate interest, which trademarks have been registered and are being used in bad faith.

5.5.3 Registrar knowingly employs any officer that is convicted of a misdemeanor related to financial activities or of any felony, or is judged by a court of competent jurisdiction to have committed fraud or breach of fiduciary duty, or is the subject of a judicial determination that ICANN reasonably deems as the substantive equivalent of any of the foregoing and such officer is not terminated within thirty (30) days of Registrar's knowledge of the foregoing; or any member of Registrar's board of directors or similar governing body is convicted of a misdemeanor related to financial activities or of any felony, or is judged by a court of competent jurisdiction to have committed fraud or breach of fiduciary duty, or is the subject of a judicial determination that ICANN reasonably deems as the substantive equivalent of any of the foregoing and such member is not removed from Registrar's board of directors or similar governing body within thirty (30) days of Registrar's knowledge of the foregoing.

5.5.4 Registrar fails to cure any breach of this Agreement within twenty-one (21) days after ICANN gives Registrar notice of the breach.

5.5.5 Registrar fails to comply with a ruling granting specific performance under Sections 5.7 or 7.1.

5.5.6 Registrar has been in fundamental and material breach of its obligations under this Agreement at least three (3) times within a twelve (12) month period.



5.5.7 Registrar continues acting in a manner that ICANN has reasonably determined endangers the stability or operational integrity of the Internet after receiving three (3) days notice of that determination.

5.5.8 (i) Registrar makes an assignment for the benefit of creditors or similar act; (ii) attachment, garnishment or similar proceedings are commenced against Registrar, which proceedings are a material threat to Registrar's ability to provide Registrar Services for gTLDs, and are not dismissed within sixty (60) days of their commencement; (iii) a trustee, receiver, liquidator or equivalent is appointed in place of Registrar or maintains control over any of Registrar's property; (iv) execution is levied upon any property of Registrar, (v) proceedings are instituted by or against Registrar under any bankruptcy, insolvency, reorganization or other laws relating to the relief of debtors and such proceedings are not dismissed within thirty (30) days of their commencement, or (vi) Registrar files for protection under the United States Bankruptcy Code, 11 U.S.C. Section 101 et seq., or a foreign equivalent or liquidates, dissolves or otherwise discontinues its operations.

5.6 Termination Procedures. This Agreement may be terminated in circumstances described in Subsections 5.5.1 through 5.5.6 above only upon fifteen (15) days written notice to Registrar (in the case of Subsection 5.5.4 occurring after Registrar's failure to cure), with Registrar being given an opportunity during that time to initiate arbitration under Subsection 5.8 to determine the appropriateness of termination under this Agreement. This Agreement may be terminated immediately upon notice to Registrar in circumstances described in Subsections 5.5.7 and 5.5.8.

#### 5.7 Suspension.

5.7.1 Upon the occurrence of any of the circumstances set forth in Section 5.5, ICANN may, in ICANN's sole discretion, upon delivery of a notice pursuant to Subsection 5.7.2, elect to suspend Registrar's ability to create or sponsor new Registered Names or initiate inbound transfers of Registered Names for any or all gTLDs for a period of up to a twelve (12) months following the effectiveness of such suspension. Suspension of a Registrar does not preclude ICANN's ability to issue a notice of termination in accordance with the notice requirements of Section 5.6.

5.7.2 Any suspension under Subsections 5.7.1 will be effective upon fifteen (15) days written notice to Registrar, with Registrar being given an opportunity during that time to initiate arbitration under Subsection 5.8 to determine the appropriateness of suspension under this Agreement.

5.7.3 Upon suspension, Registrar shall notify users, by posting a prominent notice on its web site, that it is unable to create or sponsor new gTLD domain

name registrations or initiate inbound transfers of Registered Names. Registrar's notice shall include a link to the notice of suspension from ICANN.

5.7.4 If Registrar acts in a manner that ICANN reasonably determines endangers the stability or operational integrity of the Internet and upon notice does not immediately cure, ICANN may suspend this Agreement for five (5) working days pending ICANN's application for more extended specific performance or injunctive relief under Subsection 7.1. Suspension of the Agreement under this Subsection may, at ICANN's sole discretion, preclude the Registrar from (i) providing Registration Services for gTLDs delegated by ICANN on or after the date of delivery of such notice to Registrar and (ii) creating or sponsoring new Registered Names or initiating inbound transfers of Registered Names for any gTLDs. Registrar must also post the statement specified in Subsection 5.7.3.

5.8 Resolution of Disputes Under this Agreement. Subject to the limitations set forth in Section 6 and Section 7.4, disputes arising under or in connection with this Agreement, including (1) disputes arising from ICANN's failure to renew Registrar's Accreditation and (2) requests for specific performance, shall be resolved in a court of competent jurisdiction or, at the election of either party, by an arbitration conducted as provided in this Subsection 5.8 pursuant to the International Arbitration Rules of the American Arbitration Association ("AAA"). The arbitration shall be conducted in English and shall occur in Los Angeles County, California, USA. Except as set forth in Section 7.4.5, there shall be one (1) arbitrator agreed by the parties from a list of AAA arbitrators, or if parties do not agree on an arbitrator within fifteen (15) days of the AAA request that the parties designate an arbitrator, the AAA shall choose and appoint an arbitrator, paying due regard to the arbitrator's knowledge of the DNS. The parties shall bear the costs of the arbitration in equal shares, subject to the right of the arbitrator to reallocate the costs in their award as provided in the AAA rules. The parties shall bear their own attorneys' fees in connection with the arbitration, and the arbitrator may not reallocate the attorneys' fees in conjunction with their award. The arbitrator shall render its decision within ninety (90) days of the conclusion of the arbitration hearing. In the event Registrar initiates arbitration to contest the appropriateness of termination of this Agreement by ICANN pursuant to Section 5.5 or suspension of Registrar by ICANN pursuant to Section 5.7.1, Registrar may at the same time request that the arbitration panel stay the termination or suspension until the arbitration decision is rendered. The arbitration panel shall order a stay: (i) upon showing by Registrar that continued operations would not be harmful to consumers or the public interest, or (ii) upon appointment by the arbitration panel of a qualified third party to manage the operations of the Registrar until the arbitration decision is rendered. In furtherance of sub-clause (ii) above, the arbitration panel is hereby granted all necessary authority to appoint a qualified third-party to manage the operations of the Registrar upon the Registrar's request and if the panel deems it appropriate. In selecting the third-party manager, the arbitration panel shall take into consideration, but shall not be bound by, any expressed preferences of Registrar. Any order

granting a request for a stay must be issued within fourteen (14) days after the filing of the arbitration. If an order granting a request for a stay is not issued within fourteen (14) days, ICANN has the right to proceed with the termination of this Agreement pursuant to Section 5.5 or suspension of the Registrar pursuant to Section 5.7.1. In the event Registrar initiates arbitration to contest an Independent Review Panel's decision under Subsection 4.3.3 sustaining the ICANN Board of Director's determination that a specification or policy is supported by consensus, Registrar may at the same time request that the arbitration panel stay the requirement that it comply with the policy until the arbitration decision is rendered, and that request shall have the effect of staying the requirement until the decision or until the arbitration panel has granted an ICANN request for lifting of the stay. In all litigation involving ICANN concerning this Agreement (whether in a case where arbitration has not been elected or to enforce an arbitration award), jurisdiction and exclusive venue for such litigation shall be in a court located in Los Angeles, California, USA; however, the parties shall also have the right to enforce a judgment of such a court in any court of competent jurisdiction. For the purpose of aiding the arbitration and/or preserving the rights of the parties during the pendency of an arbitration, the parties shall have the right to seek temporary or preliminary injunctive relief from the arbitration panel or in a court located in Los Angeles, California, USA, which shall not be a waiver of this arbitration agreement.

5.9 Limitations on Monetary Remedies for Violations of this Agreement. ICANN's aggregate monetary liability for violations of this Agreement shall not exceed an amount equal to the Accreditation fees paid by Registrar to ICANN under Subsection 3.9 of this Agreement during the preceding twelve-month period. Registrar's monetary liability to ICANN for violations of this Agreement shall be limited to Accreditation fees owing to ICANN under this Agreement and, except in the case of a good faith disagreement concerning the interpretation of this agreement, reasonable payment to ICANN for the reasonable and direct costs including attorney fees, staff time, and other related expenses associated with legitimate efforts to enforce Registrar compliance with this agreement and costs incurred by ICANN to respond to or mitigate the negative consequences of such behavior for Registered Name Holders and the Internet community. In the event of repeated willful material breaches of the agreement, Registrar shall be liable for sanctions of up to five (5) times ICANN's enforcement costs, but otherwise in no event shall either party be liable for special, indirect, incidental, punitive, exemplary, or consequential damages for any violation of this Agreement.

## **6. AMENDMENT AND WAIVER.**

6.1 If the ICANN Board of Directors determines that an amendment to this Agreement (including to the Specifications referred to herein, unless such Specifications expressly do not permit amendment thereto) and all other registrar agreements between ICANN and the Applicable Registrars (the "Applicable Registrar Agreements") is desirable (each, a "Special Amendment"), ICANN may adopt a Special Amendment pursuant to the requirements of and process set forth

in this Section 6; provided that a Special Amendment may not be a Restricted Amendment.

6.2 Prior to submitting a Special Amendment for Registrar Approval, ICANN shall first consult in good faith with the Working Group regarding the form and substance of such Special Amendment. The duration of such consultation shall be reasonably determined by ICANN based on the substance of the Special Amendment. Following such consultation, ICANN may propose the adoption of a Special Amendment by publicly posting such amendment on its website for no less than thirty (30) calendar days (the "Posting Period") and providing notice of such proposed amendment to the Applicable Registrars in accordance with Section 7.6. ICANN will consider the public comments submitted on a Special Amendment during the Posting Period (including comments submitted by the Applicable Registrars).

6.3 If, within one hundred eighty (180) calendar days following the expiration of the Posting Period (the "Approval Period"), the ICANN Board of Directors approves a Special Amendment (which may be in a form different than submitted for public comment, but must address the subject matter of the Special Amendment posted for public comment, as modified to reflect and/or address input from the Working Group and public comments), ICANN shall provide notice of, and submit, such Special Amendment for approval or disapproval by the Applicable Registrars. If, during the sixty (60) calendar day period following the date ICANN provides such notice to the Applicable Registrars, such Special Amendment receives Registrar Approval, such Special Amendment shall be deemed approved (an "Approved Amendment") by the Applicable Registrars, and shall be effective and deemed an amendment to this Agreement on the date that is sixty (60) calendar days following the date ICANN provided notice of the approval of such Approved Amendment to Registrar (the "Amendment Effective Date"). In the event that a Special Amendment does not receive Registrar Approval, the Special Amendment shall be deemed not approved by the Applicable Registrars (a "Rejected Amendment"). A Rejected Amendment will have no effect on the terms and conditions of this Agreement, except as set forth below.

6.4 If the ICANN Board of Directors reasonably determines that a Rejected Amendment falls within the subject matter categories set forth in Section 1.2 of [the Consensus Policies and Temporary Policies](#) Specification-~~1~~, the ICANN Board of Directors may adopt a resolution (the date such resolution is adopted is referred to herein as the "Resolution Adoption Date") requesting an Issue Report (as such term is defined in ICANN's Bylaws) by the Generic Names Supporting Organization (the "GNSO") regarding the substance of such Rejected Amendment. The policy development process undertaken by the GNSO pursuant to such requested Issue Report is referred to herein as a "PDP." If such PDP results in a Final Report supported by a GNSO Supermajority (as defined in ICANN's Bylaws) that either (i) recommends adoption of the Rejected Amendment as Consensus Policy or (ii) recommends against adoption of the Rejected Amendment as Consensus Policy, and, in the case of (i) above, the Board adopts such Consensus Policy, Registrar shall

comply with its obligations pursuant to Section 4 of this Agreement. In either case, ICANN will abandon the Rejected Amendment and it will have no effect on the terms and conditions of this Agreement. Notwithstanding the foregoing provisions of this Section 6.4, the ICANN Board of Directors shall not be required to initiate a PDP with respect to a Rejected Amendment if, at any time in the twelve (12) month period preceding the submission of such Rejected Amendment for Registrar Approval pursuant to Section 6.3, the subject matter of such Rejected Amendment was the subject of a concluded or otherwise abandoned or terminated PDP that did not result in a GNSO Supermajority recommendation.

6.5 If (i) a Rejected Amendment does not fall within the subject matter categories set forth in Section 1.2 of [the Consensus Policies and Temporary Policies Specification 1](#), (ii) the subject matter of a Rejected Amendment was, at any time in the twelve (12) month period preceding the submission of such Rejected Amendment for Registrar Approval pursuant to Section 6.3, the subject of a concluded or otherwise abandoned or terminated PDP that did not result in a GNSO Supermajority recommendation, or (iii) a PDP does not result in a Final Report supported by a GNSO Supermajority that either (a) recommends adoption of the Rejected Amendment as Consensus Policy or (b) recommends against adoption of the Rejected Amendment as Consensus Policy (or such PDP has otherwise been abandoned or terminated for any reason), then, in any such case, such Rejected Amendment may still be adopted and become effective in the manner described below. In order for the Rejected Amendment to be adopted, the following requirements must be satisfied:

6.5.1 the subject matter of the Rejected Amendment must be within the scope of ICANN's mission and consistent with a balanced application of its core values (as described in ICANN's Bylaws);

6.5.2 the Rejected Amendment must be justified by a Substantial and Compelling Reason in the Public Interest, must be likely to promote such interest, taking into account competing public and private interests that are likely to be affected by the Rejected Amendment, and must be narrowly tailored and no broader than reasonably necessary to address such Substantial and Compelling Reason in the Public Interest;

6.5.3 to the extent the Rejected Amendment prohibits or requires conduct or activities, imposes material costs on the Applicable Registrars, and/or materially reduces public access to domain name services, the Rejected Amendment must be the least restrictive means reasonably available to address the Substantial and Compelling Reason in the Public Interest;

6.5.4 the ICANN Board of Directors must submit the Rejected Amendment, along with a written explanation of the reasoning related to its determination that the Rejected Amendment meets the requirements set out in subclauses

(i) through (iii) above, for public comment for a period of no less than thirty (30) calendar days; and

6.5.5 following such public comment period, the ICANN Board of Directors must (i) engage in consultation (or direct ICANN management to engage in consultation) with the Working Group, subject matter experts, members of the GNSO, relevant advisory committees and other interested stakeholders with respect to such Rejected Amendment for a period of no less than sixty (60) calendar days; and (ii) following such consultation, reapprove the Rejected Amendment (which may be in a form different than submitted for Registrar Approval, but must address the subject matter of the Rejected Amendment, as modified to reflect and/or address input from the Working Group and public comments) by the affirmative vote of at least two-thirds of the members of the ICANN Board of Directors eligible to vote on such matter, taking into account any ICANN policy affecting such eligibility, including ICANN's Conflict of Interest Policy (a "Board Amendment").

Such Board Amendment shall, subject to Section 6.6, be deemed an Approved Amendment, and shall be effective and deemed an amendment to this Agreement on the date that is sixty (60) calendar days following the date ICANN provided notice of the approval of such Board Amendment to Registrar (which effective date shall be deemed the Amendment Effective Date hereunder). Notwithstanding the foregoing, a Board Amendment may not amend the registrar fees charged by ICANN hereunder, or amend this Section 6.

6.6 Notwithstanding the provisions of Section 6.5, a Board Amendment shall not be deemed an Approved Amendment if, during the thirty (30) calendar day period following the approval by the ICANN Board of Directors of the Board Amendment, the Working Group, on the behalf of the Applicable Registrars, submits to the ICANN Board of Directors an alternative to the Board Amendment (an "Alternative Amendment") that meets the following requirements:

6.6.1 sets forth the precise text proposed by the Working Group to amend this Agreement in lieu of the Board Amendment;

6.6.2 addresses the Substantial and Compelling Reason in the Public Interest identified by the ICANN Board of Directors as the justification for the Board Amendment; and

6.6.3 compared to the Board Amendment is: (a) more narrowly tailored to address such Substantial and Compelling Reason in the Public Interest, and (b) to the extent the Alternative Amendment prohibits or requires conduct or activities, imposes material costs on Affected Registrars, or materially reduces access to domain name services, is a less restrictive means to address the Substantial and Compelling Reason in the Public Interest.

Any proposed amendment that does not meet the requirements of subclauses 6.6.1 through 6.6.3 in the immediately preceding sentence shall not be considered an Alternative Amendment hereunder and therefore shall not supersede or delay the effectiveness of the Board Amendment. If, following the submission of the Alternative Amendment to the ICANN Board of Directors, the Alternative Amendment receives Registrar Approval, the Alternative Amendment shall supersede the Board Amendment and shall be deemed an Approved Amendment hereunder (and shall be effective and deemed an amendment to this Agreement on the date that is sixty (60) calendar days following the date ICANN provided notice of the approval of such Alternative Amendment to Registrar, which effective date shall be deemed the Amendment Effective Date hereunder), unless, within a period of sixty (60) calendar days following the date that the Working Group notifies the ICANN Board of Directors of Registrar Approval of such Alternative Amendment (during which time ICANN shall engage with the Working Group with respect to the Alternative Amendment), the ICANN Board of Directors by the affirmative vote of at least two-thirds of the members of the ICANN Board of Directors eligible to vote on such matter, taking into account any ICANN policy affecting such eligibility, including ICANN's Conflict of Interest Policy, rejects the Alternative Amendment. If (A) the Alternative Amendment does not receive Registrar Approval within thirty (30) days of submission of such Alternative Amendment to the Applicable Registrars (and the Working Group shall notify ICANN of the date of such submission), or (B) the ICANN Board of Directors rejects the Alternative Amendment by such two-thirds vote, the Board Amendment (and not the Alternative Amendment) shall be effective and deemed an amendment to this Agreement on the date that is sixty (60) calendar days following the date ICANN provided notice to Registrar (which effective date shall be deemed the Amendment Effective Date hereunder). If the ICANN Board of Directors rejects an Alternative Amendment, the board shall publish a written rationale setting forth its analysis of the criteria set forth in Sections 6.6.1 through 6.6.3. The ability of the ICANN Board of Directors to reject an Alternative Amendment hereunder does not relieve the Board of the obligation to ensure that any Board Amendment meets the criteria set forth in Section 6.5.1 through 6.5.5.

6.7 In the event that Registrar believes an Approved Amendment does not meet the substantive requirements set out in this Section 6 or has been adopted in contravention of any of the procedural provisions of this Section 6, Registrar may challenge the adoption of such Special Amendment pursuant to the dispute resolution provisions set forth in Section 5.8, except that such arbitration shall be conducted by a three-person arbitration panel. Any such challenge must be brought within sixty (60) calendar days following the date ICANN provided notice to Registrar of the Approved Amendment, and ICANN may consolidate all challenges brought by registrars (including Registrar) into a single proceeding. The Approved Amendment will be deemed not to have amended this Agreement during the pendency of the dispute resolution process.

6.8 Registrar may apply in writing to ICANN for an exemption from the Approved Amendment (each such request submitted by Registrar hereunder, an "Exemption

Request”) during the thirty (30) calendar day period following the date ICANN provided notice to Registrar of such Approved Amendment.

6.8.1 Each Exemption Request will set forth the basis for such request and provide detailed support for an exemption from the Approved Amendment. An Exemption Request may also include a detailed description and support for any alternatives to, or a variation of, the Approved Amendment proposed by such Registrar.

6.8.2 An Exemption Request may only be granted upon a clear and convincing showing by Registrar that compliance with the Approved Amendment conflicts with applicable laws or would have a material adverse effect on the long-term financial condition or results of operations of Registrar. No Exemption Request will be granted if ICANN determines, in its reasonable discretion, that granting such Exemption Request would be materially harmful to registrants or result in the denial of a direct benefit to registrants.

6.8.3 Within ninety (90) calendar days of ICANN’s receipt of an Exemption Request, ICANN shall either approve (which approval may be conditioned or consist of alternatives to or a variation of the Approved Amendment) or deny the Exemption Request in writing, during which time the Approved Amendment will not amend this Agreement.

6.8.4 If the Exemption Request is approved by ICANN, the Approved Amendment will not amend this Agreement; provided, that any conditions, alternatives or variations of the Approved Amendment required by ICANN shall be effective and, to the extent applicable, will amend this Agreement as of the Amendment Effective Date. If such Exemption Request is denied by ICANN, the Approved Amendment will amend this Agreement as of the Amendment Effective Date (or, if such date has passed, such Approved Amendment shall be deemed effective immediately on the date of such denial), provided that Registrar may, within thirty (30) calendar days following receipt of ICANN’s determination, appeal ICANN’s decision to deny the Exemption Request pursuant to the dispute resolution procedures set forth in Section 5.8.

6.8.5 The Approved Amendment will be deemed not to have amended this Agreement during the pendency of the dispute resolution process. For avoidance of doubt, only Exemption Requests submitted by Registrar that are approved by ICANN pursuant to this Article 6 or through an arbitration decision pursuant to Section 5.8 shall exempt Registrar from any Approved Amendment, and no Exemption Request granted to any other Applicable Registrar (whether by ICANN or through arbitration), shall have any effect under this Agreement or exempt Registrar from any Approved Amendment.



6.9 Except as set forth in Section 4, Subsection 5.3, this Section 6, Section 7.4 and as otherwise set forth in this Agreement and the Specifications hereto, no amendment, supplement or modification of this Agreement or any provision hereof shall be binding unless executed in writing by both parties, and nothing in this Section 6 or Section 7.4 shall restrict ICANN and Registrar from entering into bilateral amendments and modifications to this Agreement negotiated solely between the two parties. No waiver of any provision of this Agreement shall be binding unless evidenced by a writing signed by the party waiving compliance with such provision. No waiver of any of the provisions of this Agreement or failure to enforce any of the provisions hereof shall be deemed or shall constitute a waiver of any other provision hereof, nor shall any such waiver constitute a continuing waiver unless otherwise expressly provided. For the avoidance of doubt, nothing in this Section 6 or Section 7.4 shall be deemed to limit Registrar's obligation to comply with Section 4.

~~6.10 Definitions: For purposes of this Section 6, the following:~~

~~6.10.1 "Applicable Registrar Family" means, with respect to Affiliated Registrars, such Affiliated Registrar as a group.~~

~~6.10.2 "Registrar Approval" means the receipt of either of the following approvals:~~

~~6.10.2.1 The affirmative approval of Applicable Registrars accounting for 90% of the Total Registered Names Under Management by the Applicable Registrars; provided that, for purposes of calculating the Total Registered Names Under Management by Applicable Registrars, the Total Registered Names Under Management by each Applicable Registrar Family shall not exceed the Total Registered Names Under Management of the Applicable Registrar Family that is the fifth largest Applicable Registrar Family (measured by number of Registered Names Under Management), both for purposes of the numerator and the denominator; or~~

~~6.10.2.2 The affirmative approval of 50% plus one of the Applicable Registrars that participate in the process to approve or disapprove (i.e. vote for or against, but not abstain or otherwise fail to vote) a proposed amendment under this Section 6, and the affirmative approval of Applicable Registrars accounting for 66.67% of the Total Registered Names Under Management by all Applicable Registrars; provided that, for purposes of calculating the Total Registered Names Under Management by Applicable Registrars, the Total Registered Names Under Management by each Applicable Registrar Family shall not exceed the total Registered Names Under Management of the Applicable Registrar Family that is the fifth largest Applicable Registrar Family (measured by number of Registered Names Under~~

~~Management), both for purposes of the numerator and the denominator. An example of these calculations is set forth in Appendix 1 attached hereto.~~

~~6.10.3 “Restricted Amendment” means (i) an amendment of the Consensus Policies and Temporary Policies Specification or (ii) the term of this Agreement as specified in Section 5.1, as such term may be extended pursuant to Section 5.2.~~

~~6.10.4 “Total Registered Names Under Management” means the total number of Registered Names sponsored by all Applicable Registrars as reflected in the latest monthly reports submitted to ICANN by Registrars.~~

~~6.10.5 “Working Group” means representatives of the Applicable Registrars and other members of the community that the Registrar Stakeholder Group appoints, from time to time, to serve as a working group to consult on amendments to the Applicable Registrar Agreements (excluding bilateral amendments pursuant to Section 6.9).~~

~~6.10.6~~6.10 Notwithstanding anything in this Section ~~6.10~~6 to the contrary, (a) if Registrar provides evidence to ICANN’s reasonable satisfaction that the Approved Amendment would materially increase the cost of providing Registrar Services, then ICANN will allow up to one-hundred eighty (180) calendar days for the Approved Amendment to become effective with respect to Registrar, and (b) no Approved Amendment adopted pursuant to Section ~~6.10~~6 shall become effective with respect to Registrar if Registrar provides ICANN with an irrevocable notice of termination pursuant to Section 5.4.

## **7. MISCELLANEOUS PROVISIONS.**

7.1 Specific Performance. While this Agreement is in effect, either party may seek specific performance of any provision of this Agreement in the manner provided in Section 5.8, provided the party seeking such performance is not in material breach of its obligations.

7.2 Handling by ICANN of Registrar-Supplied Data. Before receiving any Personal Data from Registrar, ICANN shall specify to Registrar in writing the purposes for and conditions under which ICANN intends to use the Personal Data. ICANN may from time to time provide Registrar with a revised specification of such purposes and conditions, which specification shall become effective no fewer than thirty (30) days after it is provided to Registrar. ICANN shall not use Personal Data provided by Registrar for a purpose or under conditions inconsistent with the specification in effect when the Personal Data was provided. ICANN shall take reasonable steps to avoid uses of the Personal Data by third parties inconsistent with the specification.

7.3 Assignment; Change of Ownership or Management.

7.3.1 Except as set forth in this Section 7.3.1, either party may assign or transfer this Agreement only with the prior written consent of the other party, which shall not be unreasonably withheld. If ICANN fails to expressly provide or withhold its consent to any requested assignment (an "Assignment Request") of this Agreement by Registrar within thirty (30) calendar days of ICANN's receipt of notice of such Assignment Request (or, if ICANN has requested additional information from Registrar in connection with its review of such request, sixty (60) calendar days of the receipt of all requested written information regarding such request) from Registrar, ICANN shall be deemed to have consented to such requested assignment. Notwithstanding the foregoing, (i) ICANN may assign this Agreement without the consent of Registrar upon approval of the ICANN Board of Directors in conjunction with a reorganization, reconstitution or re-incorporation of ICANN upon such assignee's express assumption of the terms and conditions of this Agreement, (ii) Registrar may assign this Agreement without the consent of ICANN to a wholly-owned subsidiary of Registrar upon such subsidiary's express assumption of the terms and conditions of this Agreement, and (iii) ICANN shall be deemed to have consented to an Assignment Request in which the assignee associated with such Assignment Request is a party to a Registrar Accreditation Agreement with ICANN on the terms set forth in this Agreement (provided that such assignee is then in compliance with the terms and conditions of such Registrar Accreditation Agreement in all material respects), unless ICANN provides to Registrar a written objection to such Assignment Request within ten (10) calendar days of ICANN's receipt of notice of such Assignment Request pursuant to this Section 7.3.1.

7.3.2 To the extent that an entity acquires a Controlling interest in Registrar's stock, assets or business, Registrar shall provide ICANN notice within seven (7) days of such an acquisition. Such notification shall include a statement that affirms that Registrar meets the Specification or Policy on Accreditation criteria then in effect, and is in compliance with its obligations under this Agreement. Within thirty (30) days of such notification, ICANN may request additional information from the Registrar establishing compliance with this Agreement, in which case Registrar must supply the requested information within fifteen (15) days. Any disputes concerning Registrar's continued Accreditation shall be resolved pursuant to Section 5.8.

#### 7.4 Negotiation Process.

7.4.1 If either the Chief Executive Officer of ICANN ("CEO") or the Chairperson of the Registrar Stakeholder Group ("Chair") desires to discuss any revision(s) to this Agreement, the CEO or Chair, as applicable, shall provide written notice to the other person, which shall set forth in reasonable detail the proposed revisions to this Agreement (a "Negotiation Notice"). Notwithstanding the foregoing, neither the CEO nor the Chair may (i) propose revisions to this Agreement that modify any Consensus Policy then existing, (ii)

propose revisions to this Agreement pursuant to this Section 7.4 on or before June 30, 2014, or (iii) propose revisions or submit a Negotiation Notice more than once during any twelve month period beginning on July 1, 2014.

7.4.2 Following receipt of the Negotiation Notice by either the CEO or the Chair, ICANN and the Working Group ~~(as defined in Section 6.10.4)~~ shall consult in good faith negotiations regarding the form and substance of the proposed revisions to this Agreement, which shall be in the form of a proposed amendment to this Agreement (the “Proposed Revisions”), for a period of at least ninety (90) calendar days (unless a resolution is earlier reached) and attempt to reach a mutually acceptable agreement relating to the Proposed Revisions (the “Discussion Period”).

7.4.3 If, following the conclusion of the Discussion Period, an agreement is reached on the Proposed Revisions, ICANN shall post the mutually agreed Proposed Revisions on its website for public comment for no less than thirty (30) calendar days (the “Posting Period”) and provide notice of such revisions to all Applicable Registrars in accordance with Section 7.6. ICANN and the Working Group will consider the public comments submitted on the Proposed Revisions during the Posting Period (including comments submitted by the Applicable Registrars). Following the conclusion of the Posting Period, the Proposed Revisions shall be submitted for Registrar Approval ~~(as defined in Section 6.10.2)~~ and approval by the ICANN Board of Directors. If such approvals are obtained, the Proposed Revisions shall be deemed an Approved Amendment ~~(as defined in Section 6.4)~~ by the Applicable Registrars and ICANN, and shall be effective and deemed an amendment to this Agreement upon sixty (60) calendar days notice from ICANN to Registrar.

7.4.4 If, following the conclusion of the Discussion Period, an agreement is not reached between ICANN and the Working Group on the Proposed Revisions, either the CEO or the Chair may provide the other person written notice (the “Mediation Notice”) requiring each party to attempt to resolve the disagreements related to the Proposed Revisions through impartial, facilitative (non-evaluative) mediation in accordance with the terms and conditions set forth below. In the event that a Mediation Notice is provided, ICANN and the Working Group shall, within fifteen (15) calendar days thereof, simultaneously post the text of their desired version of the Proposed Revisions and a position paper with respect thereto on ICANN’s website.

7.4.4.1 The mediation shall be conducted by a single mediator selected by the parties. If the parties cannot agree on a mediator within fifteen (15) calendar days following receipt by the CEO or Chair, as applicable, of the Mediation Notice, the parties will promptly select a mutually acceptable mediation provider entity, which entity shall, as soon as practicable following such entity’s selection, designate a mediator, who is a licensed attorney with general knowledge of

contract law and, to the extent necessary to mediate the particular dispute, general knowledge of the domain name system. Any mediator must confirm in writing that he or she is not, and will not become during the term of the mediation, an employee, partner, executive officer, director, or security holder of ICANN or an Applicable Registrar. If such confirmation is not provided by the appointed mediator, then a replacement mediator shall be appointed pursuant to this Section 7.4.4.1.

7.4.4.2 The mediator shall conduct the mediation in accordance with the rules and procedures for facilitative mediation that he or she determines following consultation with the parties. The parties shall discuss the dispute in good faith and attempt, with the mediator's assistance, to reach an amicable resolution of the dispute.

7.4.4.3 Each party shall bear its own costs in the mediation. The parties shall share equally the fees and expenses of the mediator.

7.4.4.4 If an agreement is reached during the mediation, ICANN shall post the mutually agreed Proposed Revisions on its website for the Posting Period and provide notice to all Applicable Registrars in accordance with Section 7.6. ICANN and the Working Group will consider the public comments submitted on the agreed Proposed Revisions during the Posting Period (including comments submitted by the Applicable Registrars). Following the conclusion of the Posting Period, the Proposed Revisions shall be submitted for Registrar Approval and approval by the ICANN Board of Directors. If such approvals are obtained, the Proposed Revisions shall be deemed an Approved Amendment (~~as defined in Section 6.3~~) by the Applicable Registrars and ICANN, and shall be effective and deemed an amendment to this Agreement upon sixty (60) days notice from ICANN to Registrar.

7.4.4.5 If the parties have not resolved the dispute for any reason by the date that is ninety (90) calendar days following receipt by the CEO or Chair, as applicable, of the Mediation Notice, the mediation shall automatically terminate (unless extended by agreement of the parties). The mediator shall deliver to the parties a definition of the issues that could be considered in future arbitration, if invoked. Those issues are subject to the limitations set forth in Section 7.4.5.2 below.

7.4.5 If, following mediation, ICANN and the Working Group have not reached an agreement on the Proposed Revisions, either the CEO or the Chair may provide the other person written notice (an "Arbitration Notice") requiring ICANN and the Applicable Registry Operators to resolve the dispute

through binding arbitration in accordance with the arbitration provisions of Section 5.8, subject to the requirements and limitations of this Section 7.4.5.

7.4.5.1 If an Arbitration Notice is sent, the mediator's definition of issues, along with the Proposed Revisions (be those from ICANN, Registrars or both) shall be posted for public comment on ICANN's website for a period of no less than thirty (30) calendar days. ICANN and the Working Group will consider the public comments submitted on the Proposed Revisions during the Posting Period (including comments submitted by the Applicable Registrars), and information regarding such comments and consideration shall be provided to the a three (3) person arbitrator panel. Each party may modify is Proposed Revisions before and after the Posting Period. The arbitration proceeding may not commence prior to the closing of such public comment period, and ICANN may consolidate all challenges brought by registrars (including Registrar) into a single proceeding. Except as set forth in this Section 7.4.5.1, the arbitration shall be conducted pursuant to Section 5.8.

7.4.5.2 No dispute regarding the Proposed Revisions may be submitted for arbitration to the extent the subject matter of the Proposed Revisions (i) relates to Consensus Policy, (ii) falls within the subject matter categories set forth in Section 1.2 of [the Consensus Policies and Temporary Policies Specification 4](#), or (iii) seeks to amend any of the following provisions or Specifications of this Agreement: Sections 2, 4 and 6; subsections 3.1, 3.2, 3.3, 3.4, 3.5, 3.7, 3.8, 3.9, 3.14, 3.19, 3.21, 5.1, 5.2 or 5.3; and the Consensus Policies and Temporary Policies Specification, ~~¶Data Retention Specification~~, WHOIS Accuracy Program Specification, Registration Data Directory Service (WHOIS) Specification or the Additional Registrar Operation Specification.

7.4.5.3 The mediator will brief the arbitrator panel regarding ICANN and the Working Group's respective proposals relating to the Proposed Revisions.

7.4.5.4 No amendment to this Agreement relating to the Proposed Revisions may be submitted for arbitration by either the Working Group or ICANN, unless, in the case of the Working Group, the proposed amendment has received Registrar Approval and, in the case of ICANN, the proposed amendment has been approved by the ICANN Board of Directors.

7.4.5.5 In order for the arbitrator panel to approve either ICANN or the Working Group's proposed amendment relating to the Proposed Revisions, the arbitrator panel must conclude that such proposed

amendment is consistent with a balanced application of ICANN's core values (as described in ICANN's Bylaws) and reasonable in light of the balancing of the costs and benefits to the business interests of the Applicable Registrars and ICANN (as applicable), and the public benefit sought to be achieved by the Proposed Revisions as set forth in such amendment. If the arbitrator panel concludes that either ICANN or the Working Group's proposed amendment relating to the Proposed Revisions meets the foregoing standard, such amendment shall be effective and deemed an amendment to this Agreement upon sixty (60) calendar days notice from ICANN to Registrar and deemed an Approved Amendment hereunder.

7.4.6 With respect to an Approved Amendment relating to an amendment proposed by ICANN, Registrar may apply in writing to ICANN for an exemption from such amendment pursuant to the provisions of Section 6.8.

7.4.7 Notwithstanding anything in this Section 7.4 to the contrary, (a) if Registrar provides evidence to ICANN's reasonable satisfaction that the Approved Amendment would materially increase the cost of providing Registrar Services, then ICANN will allow up to one-hundred eighty (180) calendar days for the Approved Amendment to become effective with respect to Registrar, and (b) no Approved Amendment adopted pursuant to Section 7.4 shall become effective with respect to Registrar if Registrar provides ICANN with an irrevocable notice of termination pursuant to Section 5.4.

7.5 No Third-Party Beneficiaries. This Agreement shall not be construed to create any obligation by either ICANN or Registrar to any non-party to this Agreement, including any Registered Name Holder.

7.6 Notices and Designations. Except as provided in Section 4.4 and Section 6, all notices to be given under this Agreement shall be given in writing at the address of the appropriate party as set forth below, unless that party has given a notice of change of address in writing. Each party shall notify the other party within thirty (30) days of any change to its contact information. Any written notice required by this Agreement shall be deemed to have been properly given when delivered in person, when sent by electronic facsimile with receipt of confirmation of delivery, when scheduled for delivery by internationally recognized courier service, or when delivered by electronic means followed by an affirmative confirmation of receipt by the recipient's facsimile machine or email server. For any notice of a new Specification or Policy established in accordance with this Agreement, Registrar shall be afforded a reasonable period of time after notice of the establishment of such Specification or Policy is e-mailed to Registrar and posted on the ICANN website in which to comply with that specification, policy or program, taking into account any urgency involved. Notices and designations by ICANN under this Agreement shall be effective when written notice of them is deemed given to Registrar.

If to ICANN, addressed to:

Internet Corporation for Assigned Names and Numbers  
12025 Waterfront Drive, Suite 300  
Los Angeles, California 90094-2536 USA  
Attention: Registrar Accreditation Notices  
Telephone: 1/310/823-9358  
Facsimile: 1/310/823-8649

If to Registrar, addressed to:

[Registrar Name]  
[Courier Address]  
[Mailing Address]  
Attention: [contact person]  
Registrar Website URL: [URL]  
Telephone: [telephone number]  
Facsimile: [fax number]  
e-mail: [e-mail address]

7.7 Dates and Times. All dates and times relevant to this Agreement or its performance shall be computed based on the date and time observed in Los Angeles, California, USA.

7.8 Language. All notices, designations, and Specifications or Policies made under this Agreement shall be in the English language.

7.9 Counterparts. This Agreement may be executed in one or more counterparts, each of which shall be deemed an original, but all of which together shall constitute one and the same instrument.

7.10 Entire Agreement. Except to the extent (a) expressly provided in a written agreement executed by both parties concurrently herewith or (b) of written assurances provided by Registrar to ICANN in connection with its Accreditation, this Agreement (including the specifications, which form part of it) constitutes the entire agreement of the parties pertaining to the Accreditation of Registrar and supersedes all prior agreements, understandings, negotiations and discussions, whether oral or written, between the parties on that subject.

7.11 Severability. If one or more provisions of this Agreement are held to be unenforceable under applicable law, the parties agree to renegotiate such provision in good faith. In the event that the parties cannot reach a mutually agreeable and enforceable replacement for such provision, then (a) such provision shall be excluded from this Agreement; (b) the balance of this Agreement shall be interpreted as if such provision were so excluded; and (c) the balance of this Agreement shall be enforceable in accordance with its terms.

[signature page follows]



IN WITNESS WHEREOF, the parties hereto have caused this Agreement to be executed in duplicate by their duly authorized representatives.

**ICANN**

**[Registrar]**

By: \_\_\_\_\_

By: \_\_\_\_\_

Name: \_\_\_\_\_

Name: \_\_\_\_\_

Title: \_\_\_\_\_

Title: \_\_\_\_\_

<b>Summary Report:</b>	
<b>Litera Change-Pro ML IC 6.5.0.313 Document Comparison done on 6/20/2013 6:06:58 PM</b>	
<b>Style Name:</b> JD Color With Moves	
<b>Original Filename:</b>	
<b>Original DMS:</b> iw://IRI/IRI/33550/18	
<b>Modified Filename:</b>	
<b>Modified DMS:</b> iw://IRI/IRI/33550/19	
<b>Changes:</b>	
<u>Add</u>	44
<del>Delete</del>	48
<del>Move From</del>	16
<u>Move To</u>	16
<u>Table Insert</u>	0
<del>Table Delete</del>	0
Embedded Graphics (Visio, ChemDraw, Images etc.)	0
Embedded Excel	0
<b>Total Changes:</b>	<b>124</b>

# 2013-06-27-02c-Ref Mat-Attachment B-2013 RAA.pdf

## Attachment B – 2013 RAA

1. RAA Whois Accuracy Program Specification	2
2. Change-Pro Redline Whois Accuracy Specification	6
3. RAA Whois Specification (SLA)	11
4. Consensus and Temporary Policy Specification	16
5. Change-Pro Redline – Consensus and Temporary Policy Specification	18
6. Privacy and Proxy Registrations Specification	22
7. Change Pro Redline – Proxy Privacy Specification	24
8. RAA Data Retention Specification	28
9. RAA Registrar Information Specification	31
10. RAA Additional Registrar Operation Specification	34
11. Registrant Contractual Rights and Responsibilities	35
12. Change-Pro Redline Registrant Contractual Rights and Responsibilities	36
13. Logo License agreement	38
14. Change-Pro Redline Logo license agreement	41
15. RAA Compliance Certificate	45
16. RAA Transition Addendum	46
17. Change-Pro Redline – Transition Specification	49

Note: Open Bookmarks to access links to sections listed above

## WHOIS ACCURACY PROGRAM SPECIFICATION

Registrar shall implement and comply with the requirements set forth in this Specification, as well as any commercially practical updates to this Specification that are developed by ICANN and the Registrar Stakeholder Group during the Term of the Registrar Accreditation Agreement.

1. Except as provided for in Section 3 below, within fifteen (15) days of (1) the registration of a Registered Name sponsored by Registrar, (2) the transfer of the sponsorship of a Registered Name to Registrar, or (3) any change in the Registered Name Holder with respect to any Registered Name sponsored by Registrar, Registrar will, with respect to both Whois information and the corresponding customer account holder contact information related to such Registered Name:
  - a. Validate the presence of data for all fields required under Subsection 3.3.1 of the Agreement in a proper format for the applicable country or territory.
  - b. Validate that all email addresses are in the proper format according to RFC 5322 (or its successors).
  - c. Validate that telephone numbers are in the proper format according to the ITU-T E.164 notation for international telephone numbers (or its equivalents or successors).
  - d. Validate that postal addresses are in a proper format for the applicable country or territory as defined in UPU Postal addressing format templates, the S42 address templates (as they may be updated) or other standard formats.
  - e. Validate that all postal address fields are consistent across fields (for example: street exists in city, city exists in state/province, city matches postal code) where such information is technically and commercially available for the applicable country or territory.
  - f. Verify:
    - i. the email address of the Registered Name Holder (and, if different, the Account Holder) by sending an email requiring an affirmative response through a tool-based authentication method such as providing a unique code that must be returned in a manner designated by the Registrar, or
    - ii. the telephone number of the Registered Name Holder (and, if different, the Account Holder) by either (A) calling or sending an SMS to the Registered Name Holder's telephone number providing a unique code that must be returned in a manner designated by the Registrar, or (B) calling the Registered Name Holder's telephone number and requiring the Registered Name Holder to provide a unique code that was sent to the Registered Name Holder via web, email or postal mail.

In either case, if Registrar does not receive an affirmative response from the

Registered Name Holder, Registrar shall either verify the applicable contact information manually or suspend the registration, until such time as Registrar has verified the applicable contact information. If Registrar does not receive an affirmative response from the Account Holder), Registrar shall verify the applicable contact information manually, but is not required to suspend any registration.

2. Except as provided in Section 3 below, within fifteen (15) calendar days after receiving any changes to contact information in Whois or the corresponding customer account contact information related to any Registered Name sponsored by Registrar (whether or not Registrar was previously required to perform the validation and verification requirements set forth in this Specification in respect of such Registered Name), Registrar will validate and, to the extent required by Section 1, verify the changed fields in the manner specified in Section 1 above. If Registrar does not receive an affirmative response from the Registered Name Holder providing the required verification, Registrar shall either verify the applicable contact information manually or suspend the registration, until such time as Registrar has verified the applicable contact information. If Registrar does not receive an affirmative response from the Account Holder, Registrar shall verify the applicable contact information manually, but is not required to suspend any registration.
3. Except as set forth in paragraph 4 below, Registrar is not required to perform the above validation and verification procedures in Section 1(a) through 1(f) above, if Registrar has already successfully completed the validation and verification procedures on the identical contact information and is not in possession of facts or knowledge of circumstances that suggest that the information is no longer valid.
4. If Registrar has any information suggesting that the contact information specified in Section 1(a) through 1(f) above is incorrect (such as Registrar receiving a bounced email notification or non-delivery notification message in connection with compliance with ICANN's Whois Data Reminder Policy or otherwise) for any Registered Name sponsored by Registrar (whether or not Registrar was previously required to perform the validation and verification requirements set forth in this Specification in respect of such Registered Name), Registrar must verify or re-verify, as applicable, the email address(es) as described in Section 1.f (for example by requiring an affirmative response to a Whois Data Reminder Policy notice). If, within fifteen (15) calendar days after receiving any such information, Registrar does not receive an affirmative response from the Registered Name Holder providing the required verification, Registrar shall either verify the applicable contact information manually or suspend the registration, until such time as Registrar has verified the applicable contact information. If, within fifteen (15) calendar days after receiving any such information, Registrar does not receive an affirmative response from the customer paying for the Registered Name, if applicable, providing the required verification, Registrar shall verify the applicable contact information manually, but is not required to suspend any registration.
5. Upon the occurrence of a Registered Name Holder's willful provision of inaccurate or unreliable WHOIS information, its willful failure promptly to update information provided to Registrar, or its failure to respond for over fifteen (15) calendar days to inquiries by Registrar concerning the accuracy of contact details associated with the Registered Name Holder's

registration, Registrar shall either terminate or suspend the Registered Name Holder's Registered Name or place such registration on clientHold and clientTransferProhibited, until such time as Registrar has validated the information provided by the Registered Name Holder.

6. The terms and conditions of this Specification shall be reviewed by ICANN in consultation with the Registrar Stakeholder Group on or about the first anniversary of the date that the form of this Agreement is first executed by a registrar.
7. Nothing within this Specification shall be deemed to require Registrar to perform verification or validation of any customer account holder information where the customer account holder does not have any Registered Names under sponsorship of Registrar.





## WHOIS ACCURACY PROGRAM SPECIFICATION

Registrar shall implement and comply with the requirements set forth in this Specification, as well as any commercially practical updates to this Specification that are developed by ICANN and the Registrar Stakeholder Group during the Term of the Registrar Accreditation Agreement.

1. Except as provided for in Section 3 below, within fifteen (15) days of (1) the registration of a Registered Name sponsored by Registrar, (2) the transfer of the sponsorship of a Registered Name to Registrar, or (3) any change in the Registered Name Holder with respect to any Registered Name sponsored by Registrar, Registrar will, with respect to both Whois information and the corresponding customer account holder contact information related to such Registered Name:
  - a. Validate the presence of data for all fields required under Subsection 3.3.1 of the Agreement in a proper format for the applicable country or territory.
  - b. Validate that all email addresses are in the proper format according to RFC 5322 (or its successors).
  - c. Validate that telephone numbers are in the proper format according to the ITU-T E.164 notation for international telephone numbers (or its equivalents or successors).
  - d. Validate that postal addresses are in a proper format for the applicable country or territory as defined in UPU Postal addressing format templates, the S42 address templates (as they may be updated) or other standard formats.
  - e. Validate that all postal address fields are consistent across fields (for example: street exists in city, city exists in state/province, city matches postal code) where such information is ~~made~~technically and commercially available ~~to Registrars~~for the applicable country or territory.
  - f. Verify:
    - i. the email address of the Registered Name Holder (and, if different, the ~~account holder paying for the Registered Name~~Account Holder) by sending an email requiring an affirmative response through a tool-based authentication method such as providing a unique code that must be returned in a manner designated by the Registrar, or
    - ii. the telephone number of the Registered Name Holder (and, if different, the ~~account holder paying for the Registered Name~~Account Holder) by either (A) calling or sending an SMS to the Registered Name Holder's telephone number providing a unique code that must be returned in a manner designated by the Registrar, or (B) calling the Registered Name Holder's telephone number and requiring the Registered Name Holder to provide a unique code that was sent to the Registered Name Holder via web, email or postal mail.

In either case, if Registrar does not receive an affirmative response from the Registered Name Holder, Registrar shall either verify the applicable contact information manually or suspend the registration, until such time as Registrar has verified the applicable contact information. If Registrar does not receive an affirmative response from the ~~account holder paying for the Registered Name~~ (when that information is different from the Registered Name Account Holder), Registrar shall verify the applicable contact information manually, but is not required to suspend any registration.

2. Except as provided in Section 3 below, within fifteen (15) calendar days after receiving any changes to contact information in Whois or the corresponding customer account contact information related to any Registered Name sponsored by Registrar (whether or not Registrar was previously required to perform the validation and verification requirements set forth in this Specification in respect of such Registered Name), Registrar will validate and, to the extent required by Section 1, verify the changed fields in the manner specified in Section 1 above. If Registrar does not receive an affirmative response from the Registered Name Holder providing the required verification, Registrar shall either verify the applicable contact information manually or suspend the registration, until such time as Registrar has verified the applicable contact information. If Registrar does not receive an affirmative response from the ~~account holder paying for the Registered Name~~ Account Holder, Registrar shall verify the applicable contact information manually, but is not required to suspend any registration.
3. Except as set forth in paragraph 4 below, Registrar is not required to perform the above validation and verification procedures in Section 1(a) through 1(f) above, if Registrar has already successfully completed the validation and verification procedures on the identical contact information and is not in possession of facts or knowledge of circumstances that suggest that the information is no longer valid.
4. If Registrar has any information suggesting that the contact information specified in Section 1(a) through 1(f) above is incorrect (such as Registrar receiving a bounced email notification or non-delivery notification message in connection with compliance with ICANN's Whois Data Reminder Policy or otherwise) for any Registered Name sponsored by Registrar (whether or not Registrar was previously required to perform the validation and verification requirements set forth in this Specification in respect of such Registered Name), Registrar must verify or re-verify, as applicable, the email address(es) as described in Section 1.f (for example by requiring an affirmative response to a Whois Data Reminder Policy notice). If, within fifteen (15) calendar days after receiving any such information, Registrar does not receive an affirmative response from the Registered Name Holder providing the required verification, Registrar shall either verify the applicable contact information manually or suspend the registration, until such time as Registrar has verified the applicable contact information. If, within fifteen (15) calendar days after receiving any such information, Registrar does not receive an affirmative response from the customer paying for the Registered Name, if applicable, providing the required verification, Registrar shall verify the applicable contact information manually, but is not required to suspend any registration.
5. Upon the occurrence of a Registered Name Holder's willful provision of inaccurate or unreliable WHOIS information, its willful failure promptly to update information provided to

Registrar, or its failure to respond for over fifteen (15) calendar days to inquiries by Registrar concerning the accuracy of contact details associated with the Registered Name Holder's registration, Registrar shall either terminate or suspend the Registered Name Holder's Registered Name or place such registration on clientHold and clientTransferProhibited, until such time as Registrar has validated the information provided by the Registered Name Holder.

6. The terms and conditions of this Specification shall be reviewed by ICANN in consultation with the Registrar Stakeholder Group on or about the first anniversary of the date that the form of this Agreement is first executed by a registrar.
7. Nothing within this Specification shall be deemed to require Registrar to perform verification or validation of any customer account holder information where the customer account holder does not have any Registered Names under sponsorship of Registrar.



<b>Summary Report:</b>	
<b>Litera Change-Pro ML IC 6.5.0.313 Document Comparison done on 6/20/2013 4:47:38 PM</b>	
<b>Style Name:</b> JD Color With Moves	
<b>Original Filename:</b>	
<b>Original DMS:</b> iw://IRI/IRI/39306/10	
<b>Modified Filename:</b>	
<b>Modified DMS:</b> iw://IRI/IRI/39306/11	
<b>Changes:</b>	
<u>Add</u>	12
<del>Delete</del>	6
<del>Move From</del>	0
<u>Move To</u>	0
<u>Table Insert</u>	0
<del>Table Delete</del>	0
Embedded Graphics (Visio, ChemDraw, Images etc.)	0
Embedded Excel	0
<b>Total Changes:</b>	<b>18</b>

## REGISTRATION DATA DIRECTORY SERVICE (WHOIS) SPECIFICATION

1. **Registration Data Directory Services.** Until ICANN requires a different protocol, Registrar will operate a WHOIS service available via port 43 in accordance with RFC 3912, and a web-based Directory Service providing free public query-based access to at least the elements set forth in Section 3.3.1.1 through 3.3.1.8 of the Registrar Accreditation Agreement in the format set forth in Section 1.4 of this Specification. ICANN reserves the right to specify alternative formats and protocols, and upon such specification, the Registrar will implement such alternative specification as soon as reasonably practicable.

Following the publication by the IETF of a Proposed Standard, Draft Standard or Internet Standard and any revisions thereto (as specified in RFC 2026) relating to the web-based directory service as specified in the IETF Web Extensible Internet Registration Data Service working group, Registrar shall implement the directory service specified in any such standard (or any revision thereto) no later than 135 days after such implementation is requested by ICANN. Registrar shall implement internationalized registration data publication guidelines according to the specification published by ICANN following the work of the ICANN Internationalized Registration Data Working Group (IRD-WG) and its subsequent efforts, no later than 135 days after it is approved by the ICANN Board.

- 1.1. The format of responses shall follow a semi-free text format outline below, followed by a blank line and a legal disclaimer specifying the rights of Registrar, and of the user querying the database.
- 1.2. Each data object shall be represented as a set of key/value pairs, with lines beginning with keys, followed by a colon and a space as delimiters, followed by the value.
- 1.3. For fields where more than one value exists, multiple numbered key/value pairs with the same key shall be allowed (for example to list multiple name servers). The first key/value pair after a blank line should be considered the start of a new record, and should be considered as identifying that record, and is used to group data, such as hostnames and IP addresses, or a domain name and registrant information, together.

### 1.4. Domain Name Data:

- 1.4.1. **Query format:** whois -h whois.example-registrar.tld EXAMPLE.TLD
- 1.4.2. **Response format:**

The format of responses shall contain all the elements and follow a semi-free text format outline below. Additional data elements can be added at the end of the text

format outlined below. The data element may, at the option of Registrar, be followed by a blank line and a legal disclaimer specifying the rights of Registrar, and of the user querying the database (provided that any such legal disclaimer must be preceded by such blank line).

Domain Name: EXAMPLE.TLD  
Registry Domain ID: D1234567-TLD  
Registrar WHOIS Server: whois.example-registrar.tld  
Registrar URL: http://www.example-registrar.tld  
Updated Date: 2009-05-29T20:13:00Z  
Creation Date: 2000-10-08T00:45:00Z  
Registrar Registration Expiration Date: 2010-10-08T00:44:59Z  
Registrar: EXAMPLE REGISTRAR LLC  
Registrar IANA ID: 5555555  
Registrar Abuse Contact Email: email@registrar.tld  
Registrar Abuse Contact Phone: +1.1235551234  
Reseller: EXAMPLE RESELLER<sup>1</sup>  
Domain Status: clientDeleteProhibited<sup>2</sup>  
Domain Status: clientRenewProhibited  
Domain Status: clientTransferProhibited  
Registry Registrant ID: 5372808-ERL<sup>3</sup>  
Registrant Name: EXAMPLE REGISTRANT<sup>4</sup>  
Registrant Organization: EXAMPLE ORGANIZATION  
Registrant Street: 123 EXAMPLE STREET  
Registrant City: ANYTOWN  
Registrant State/Province: AP<sup>5</sup>  
Registrant Postal Code: A1A1A1<sup>6</sup>  
Registrant Country: AA  
Registrant Phone: +1.5555551212  
Registrant Phone Ext: 1234<sup>7</sup>  
Registrant Fax: +1.5555551213  
Registrant Fax Ext: 4321  
Registrant Email: EMAIL@EXAMPLE.TLD  
Registry Admin ID: 5372809-ERL<sup>8</sup>

---

<sup>1</sup> Data element may be deleted, provided that if the data element is used, it must appear at this location.

<sup>2</sup> Note: all applicable statuses must be displayed in the Whois output.

<sup>3</sup> May be left blank if not available from Registry.

<sup>4</sup> For the Registrant, Admin and Tech contact fields requiring a "Name" or "Organization", the output must include either the name or organization (or both, if available).

<sup>5</sup> All "State/Province" fields may be left blank if not available.

<sup>6</sup> All "Postal Code" fields may be left blank if not available.

<sup>7</sup> All "Phone Ext", "Fax" and "Fax Ext" fields may be left blank if not available.

<sup>8</sup> May be left blank if not available from Registry.

Admin Name: EXAMPLE REGISTRANT ADMINISTRATIVE  
Admin Organization: EXAMPLE REGISTRANT ORGANIZATION  
Admin Street: 123 EXAMPLE STREET  
Admin City: ANYTOWN  
Admin State/Province: AP  
Admin Postal Code: A1A1A1  
Admin Country: AA  
Admin Phone: +1.5555551212  
Admin Phone Ext: 1234  
Admin Fax: +1.5555551213  
Admin Fax Ext: 1234  
Admin Email: EMAIL@EXAMPLE.TLD  
Registry Tech ID: 5372811-ERL<sup>9</sup>  
Tech Name: EXAMPLE REGISTRANT TECHNICAL  
Tech Organization: EXAMPLE REGISTRANT LLC  
Tech Street: 123 EXAMPLE STREET  
Tech City: ANYTOWN  
Tech State/Province: AP  
Tech Postal Code: A1A1A1  
Tech Country: AA  
Tech Phone: +1.1235551234  
Tech Phone Ext: 1234  
Tech Fax: +1.5555551213  
Tech Fax Ext: 93  
Tech Email: EMAIL@EXAMPLE.TLD  
Name Server: NS01.EXAMPLE-REGISTRAR.TLD<sup>10</sup>  
Name Server: NS02.EXAMPLE-REGISTRAR.TLD  
DNSSEC: signedDelegation  
URL of the ICANN WHOIS Data Problem Reporting System:  
<http://wdprs.internic.net/>  
>>> Last update of WHOIS database: 2009-05-29T20:15:00Z <<<

- 1.5. The format of the following data fields: domain status, individual and organizational names, address, street, city, state/province, postal code, country, telephone and fax numbers, email addresses, date and times must conform to the mappings specified in EPP RFCs 5730-5734 (or its successors), and IPv6 addresses format should conform to RFC 5952 (or its successor), so that the display of this information (or values returned in WHOIS responses) can be uniformly processed and understood.

## **2. Service Level Agreement for Registration Data Directory Services (RDDS)**

### **2.1 Definitions**

---

<sup>9</sup> May be left blank if not available from Registry.

<sup>10</sup> All associated nameservers must be listed.



- **IP address.** Refers to IPv4 or IPv6 addresses without making any distinction between the two. When there is need to make a distinction, IPv4 or IPv6 is used.
- **Probes.** Network hosts used to perform tests (see below) that are located at various global locations.
- **RDDS.** Registration Data Directory Services refers to the collective of WHOIS and Web based WHOIS services.
- **RTT.** Round-Trip Time or **RTT** refers to the time measured from the sending of the first bit of the first packet of the sequence of packets needed to make a request until the reception of the last bit of the last packet of the sequence needed to receive the response. If the client does not receive the whole sequence of packets needed to consider the response as received, the request will be considered unanswered.
- **SLR.** Service Level Requirement is the level of service expected for a certain parameter being measured in a Service Level Agreement (SLA).

## 2.2 Service Level Agreement Matrix

	Parameter	SLR (monthly basis)
RDDS	RDDS availability	less than or equal to 864 min of downtime
	RDDS query RTT	less than or equal to 4000 ms, for at least 95% of the queries
	RDDS update time	less than or equal to 60 min, for at least 95% of the probes

Registrar is encouraged to do maintenance for the different services at the times and dates of statistically lower traffic for each service. Since substantial downtime is already incorporated in the availability metric, planned outages or similar; any downtime, be it for maintenance or due to system failures, will be noted simply as downtime and counted for SLA purposes.

**2.2.1 RDDS availability.** Refers to the ability of all the RDDS services for the Registrar to respond to queries from an Internet user with appropriate data from the relevant registrar system. If 51% or more of the RDDS testing probes see any of the RDDS services as unavailable during a given time, the RDDS will be considered unavailable.

**2.2.2 WHOIS query RTT.** Refers to the **RTT** of the sequence of packets from the start of the TCP connection to its end, including the reception of the WHOIS response. If the **RTT** is 5-times or more the corresponding SLR, the **RTT** will be considered undefined.

**2.2.3 Web-based-WHOIS query RTT.** Refers to the **RTT** of the sequence of packets from the start of the TCP connection to its end, including the

reception of the HTTP response for only one HTTP request. If Registrar implements a multiple-step process to get to the information, only the last step shall be measured. If the **RTT** is 5-times or more the corresponding SLR, the **RTT** will be considered undefined.

- 2.2.4 RDDS query RTT.** Refers to the collective of “**WHOIS query RTT**” and “**Web-based- WHOIS query RTT**”.
- 2.2.5 RDDS update time.** Refers to the time measured from the receipt of an EPP confirmation to a transform command on a domain name, host or contact, up until the servers of the RDDS services reflect the changes made.
- 2.2.6 RDDS test.** Means one query sent to a particular “**IP address**” of one of the servers of one of the RDDS services. Queries shall be about existing objects in the registrar system and the responses must contain the corresponding information otherwise the query will be considered unanswered. Queries with an **RTT** 5 times higher than the corresponding SLR will be considered as unanswered. The possible results to an RDDS test are: a number in milliseconds corresponding to the **RTT** or undefined/unanswered.
- 2.2.7 Measuring RDDS parameters.** Every 5 minutes, RDDS probes will select one IP address from all the public-DNS registered “**IP addresses**” of the servers for each RDDS service of the Registrar being monitored and make an “**RDDS test**” to each one. If an “**RDDS test**” result is undefined/unanswered, the corresponding RDDS service will be considered as unavailable from that probe until it is time to make a new test.
- 2.2.8 Collating the results from RDDS probes.** The minimum number of active testing probes to consider a measurement valid is 10 at any given measurement period, otherwise the measurements will be discarded and will be considered inconclusive; during this situation no fault will be flagged against the SLRs.
- 2.2.9 Placement of RDDS probes.** Probes for measuring RDDS parameters shall be placed inside the networks with the most users across the different geographic regions; care shall be taken not to deploy probes behind high propagation-delay links, such as satellite links.

### **2.3 Covenants of Performance Measurement**

Registrar shall not interfere with measurement **Probes**, including any form of preferential treatment of the requests for the monitored services. Registrar shall respond to the measurement tests described in this Specification as it would do with any other request from Internet users (for RDDS).

## CONSENSUS POLICIES AND TEMPORARY POLICIES SPECIFICATION

### 1. Consensus Policies.

- 1.1. “**Consensus Policies**” are those policies established (1) pursuant to the procedure set forth in ICANN’s Bylaws and due process, and (2) covering those topics listed in Section 1.2 of this document. The Consensus Policy development process and procedure set forth in ICANN’s Bylaws may be revised from time to time in accordance with the process set forth therein.
- 1.2. Consensus Policies and the procedures by which they are developed shall be designed to produce, to the extent possible, a consensus of Internet stakeholders, including registrars. Consensus Policies shall relate to one or more of the following:
  - 1.2.1. issues for which uniform or coordinated resolution is reasonably necessary to facilitate interoperability, security and/or stability of the Internet, Registrar Services, Registry Services, or the Domain Name System (“DNS”);
  - 1.2.2. functional and performance specifications for the provision of Registrar Services;
  - 1.2.3. registrar policies reasonably necessary to implement Consensus Policies relating to a gTLD registry;
  - 1.2.4. resolution of disputes regarding the registration of domain names (as opposed to the use of such domain names, but including where such policies take into account use of the domain names); or
  - 1.2.5. restrictions on cross-ownership of registry operators and registrars or Resellers and regulations and restrictions with respect to registrar and registry operations and the use of registry and registrar data in the event that a registry operator and a registrar or Reseller are affiliated.
- 1.3. Such categories of issues referred to in Section 1.2 shall include, without limitation:
  - 1.3.1. principles for allocation of registered names in a TLD (e.g., first-come/first-served, timely renewal, holding period after expiration);
  - 1.3.2. prohibitions on warehousing of or speculation in domain names by registries or registrars;
  - 1.3.3. reservation of registered names in a TLD that may not be registered initially or that may not be renewed due to reasons reasonably related to (i) avoidance of confusion among or misleading of users, (ii) intellectual property, or (iii) the technical management of the DNS or the Internet (e.g., establishment of reservations of names from registration);
  - 1.3.4. maintenance of and access to accurate and up-to-date information concerning Registered Names and name servers;
  - 1.3.5. procedures to avoid disruptions of domain name registrations due to suspension or termination of operations by a registry operator or a registrar, including procedures for allocation of responsibility among continuing registrars of the Registered Names sponsored in a TLD by a registrar losing accreditation; and
  - 1.3.6. the transfer of registration data upon a change in registrar sponsoring one or more Registered Names.

1.4. In addition to the other limitations on Consensus Policies, they shall not:

- 1.4.1. prescribe or limit the price of Registrar Services;
- 1.4.2. modify the limitations on Temporary Policies (defined below) or Consensus Policies;
- 1.4.3. modify the provisions in the Registrar Accreditation Agreement regarding terms or conditions for the renewal, termination or amendment of the Registrar Accreditation Agreement or fees paid by Registrar to ICANN; or
- 1.4.4. modify ICANN's obligations to not apply standards, policies, procedures or practices arbitrarily, unjustifiably, or inequitably and to not single out Registrar for disparate treatment unless justified by substantial and reasonable cause, and exercise its responsibilities in an open and transparent manner.

2. **Temporary Policies.** Registrar shall comply with and implement all specifications or policies established by the ICANN Board of Directors (the "**Board**") on a temporary basis, if adopted by the Board by a vote of at least two-thirds of its members, so long as the Board reasonably determines that such modifications or amendments are justified and that immediate temporary establishment of a specification or policy on the subject is necessary to maintain the stability or security of Registrar Services, Registry Services or the DNS or the Internet ("**Temporary Policies**").

2.1. Such proposed specification or policy shall be as narrowly tailored as feasible to achieve those objectives. In establishing any Temporary Policy, the Board shall state the period of time for which the Temporary Policy is adopted and shall immediately implement the Consensus Policy development process set forth in ICANN's Bylaws.

2.1.1. ICANN shall also issue an advisory statement containing a detailed explanation of its reasons for adopting the Temporary Policy and why the Board believes such Temporary Policy should receive the consensus support of Internet stakeholders.

2.1.2. If the period of time for which the Temporary Policy is adopted exceeds 90 days, the Board shall reaffirm its temporary adoption every 90 days for a total period not to exceed one year, in order to maintain such Temporary Policy in effect until such time as it becomes a Consensus Policy. If the one year period expires or, if during such one year period, the Temporary Policy does not become a Consensus Policy and is not reaffirmed by the Board, Registrar shall no longer be required to comply with or implement such Temporary Policy.

3. **Notice and Conflicts.** Registrar shall be afforded a reasonable period of time following notice of the establishment of a Consensus Policy or Temporary Policy in which to comply with such policy or specification, taking into account any urgency involved. In the event of a conflict between Registrar Services and Consensus Policies or any Temporary Policy, the Consensus Policies or Temporary Policy shall control, but only with respect to subject matter in conflict. For the avoidance of doubt, Consensus Policies that meet the requirements of this Specification may supplement or supersede provisions of the agreements between Registrar and ICANN, but only to the extent that such Consensus Policies relate to the matters set forth in Section 1.2 and 1.3 of this Specification.

## CONSENSUS POLICIES AND TEMPORARY POLICIES SPECIFICATION

### 1. Consensus Policies.

- 1.1. “**Consensus Policies**” are those policies established (1) pursuant to the procedure set forth in ICANN's Bylaws and due process, and (2) covering those topics listed in Section 1.2 of this document. The Consensus Policy development process and procedure set forth in ICANN's Bylaws may be revised from time to time in accordance with the process set forth therein.
- 1.2. Consensus Policies and the procedures by which they are developed shall be designed to produce, to the extent possible, a consensus of Internet stakeholders, including registrars. Consensus Policies shall relate to one or more of the following:
  - 1.2.1. issues for which uniform or coordinated resolution is reasonably necessary to facilitate interoperability, security and/or stability of the Internet, Registrar Services, Registry Services, or the Domain Name System (“DNS”);
  - 1.2.2. functional and performance specifications for the provision of Registrar Services;
  - 1.2.3. registrar policies reasonably necessary to implement Consensus Policies relating to a gTLD registry;
  - 1.2.4. resolution of disputes regarding the registration of domain names (as opposed to the use of such domain names, but including where such policies take into account use of the domain names); or
  - 1.2.5. restrictions on cross-ownership of registry operators and registrars or Resellers and regulations and restrictions with respect to registrar and registry operations and the use of registry and registrar data in the event that a registry operator and a registrar or Reseller are affiliated.
- 1.3. Such categories of issues referred to in Section 1.2 shall include, without limitation:
  - 1.3.1. principles for allocation of registered names in a TLD (e.g., first-come/first-served, timely renewal, holding period after expiration);
  - 1.3.2. prohibitions on warehousing of or speculation in domain names by registries or registrars;
  - 1.3.3. reservation of registered names in a TLD that may not be registered initially or that may not be renewed due to reasons reasonably related to (i) avoidance of confusion among or misleading of users, (ii) intellectual property, or (iii) the technical management of the DNS or the Internet (e.g., establishment of reservations of names from registration);
  - 1.3.4. maintenance of and access to accurate and up-to-date information concerning Registered Names and name servers;
  - 1.3.5. procedures to avoid disruptions of domain name registrations due to suspension or termination of operations by a registry operator or a registrar, including procedures for allocation of responsibility among continuing registrars of the Registered Names sponsored in a TLD by a registrar losing accreditation; and

- 1.3.6. the transfer of registration data upon a change in registrar sponsoring one or more Registered Names.
- 1.4. In addition to the other limitations on Consensus Policies, they shall not:
  - 1.4.1. prescribe or limit the price of Registrar Services;
  - 1.4.2. modify the limitations on Temporary Policies (defined below) or Consensus Policies;
  - 1.4.3. modify the provisions in the Registrar Accreditation Agreement regarding terms or conditions for the renewal ~~or~~ termination [or amendment](#) of the Registrar Accreditation Agreement or fees paid by Registrar to ICANN; or
  - 1.4.4. modify ICANN's obligations to not apply standards, policies, procedures or practices arbitrarily, unjustifiably, or inequitably and to not single out Registrar for disparate treatment unless justified by substantial and reasonable cause, and exercise its responsibilities in an open and transparent manner.
2. **Temporary Policies.** Registrar shall comply with and implement all specifications or policies established by the ICANN Board of Directors (the "**Board**") on a temporary basis, if adopted by the Board by a vote of at least two-thirds of its members, so long as the Board reasonably determines that such modifications or amendments are justified and that immediate temporary establishment of a specification or policy on the subject is necessary to maintain the stability or security of Registrar Services, Registry Services or the DNS or the Internet ("**Temporary Policies**").
  - 2.1. Such proposed specification or policy shall be as narrowly tailored as feasible to achieve those objectives. In establishing any Temporary Policy, the Board shall state the period of time for which the Temporary Policy is adopted and shall immediately implement the Consensus Policy development process set forth in ICANN's Bylaws.
    - 2.1.1. ICANN shall also issue an advisory statement containing a detailed explanation of its reasons for adopting the Temporary Policy and why the Board believes such Temporary Policy should receive the consensus support of Internet stakeholders.
    - 2.1.2. If the period of time for which the Temporary Policy is adopted exceeds 90 days, the Board shall reaffirm its temporary adoption every 90 days for a total period not to exceed one year, in order to maintain such Temporary Policy in effect until such time as it becomes a Consensus Policy. If the one year period expires or, if during such one year period, the Temporary Policy does not become a Consensus Policy and is not reaffirmed by the Board, Registrar shall no longer be required to comply with or implement such Temporary Policy.
3. **Notice and Conflicts.** Registrar shall be afforded a reasonable period of time following notice of the establishment of a Consensus Policy or Temporary Policy in which to comply with such policy or specification, taking into account any urgency involved. In the event of a conflict between Registrar Services and Consensus Policies or any Temporary Policy, the Consensus Policies or Temporary Policy shall control, but only with respect to subject matter in conflict. For the avoidance of doubt, Consensus Policies that meet the requirements of this Specification may supplement or supersede provisions of the agreements between Registrar and ICANN, but only to the extent that such Consensus Policies relate to the matters set forth in Section 1.2 and 1.3 of this Specification.



<b>Summary Report:</b>	
<b>Litera Change-Pro ML IC 6.5.0.313 Document Comparison done on 6/19/2013 5:14:53 PM</b>	
<b>Style Name:</b> JD Color With Moves	
<b>Original Filename:</b>	
<b>Original DMS:</b> iw://IRI/IRI/33939/6	
<b>Modified Filename:</b>	
<b>Modified DMS:</b> iw://IRI/IRI/33939/7	
<b>Changes:</b>	
<u>Add</u>	3
<del>Delete</del>	2
<del>Move From</del>	0
<u>Move To</u>	0
<u>Table Insert</u>	0
<del>Table Delete</del>	0
Embedded Graphics (Visio, ChemDraw, Images etc.)	0
Embedded Excel	0
<b>Total Changes:</b>	<b>5</b>



## **SPECIFICATION ON PRIVACY AND PROXY REGISTRATIONS**

Until the earlier to occur of (i) January 1, 2017, and (ii) the date ICANN establishes and implements a Privacy and Proxy Accreditation Program as referenced in Section 3.14 of the Registrar Accreditation Agreement, Registrar agrees to comply, and to require its Affiliates and Resellers to comply, with the terms of this Specification, provided that ICANN and the Working Group may mutually agree to extend the term of this Specification. This Specification may not be modified by ICANN or Registrar.

1. Definitions. For the purposes of this Specification, the following definitions shall apply.
  - 1.1 “P/P Customer” means, regardless of the terminology used by the P/P Provider, the licensee, customer, beneficial user, beneficiary, or other recipient of Privacy Services and Proxy Services.
  - 1.2 “Privacy Service” is a service by which a Registered Name is registered to its beneficial user as the Registered Name Holder, but for which alternative, reliable contact information is provided by the P/P Provider for display of the Registered Name Holder’s contact information in the Registration Data Service (Whois) or equivalent services.
  - 1.3 “Proxy Service” is a service through which a Registered Name Holder licenses use of a Registered Name to the P/P Customer in order to provide the P/P Customer use of the domain name, and the Registered Name Holder’s contact information is displayed in the Registration Data Service (Whois) or equivalent services rather than the P/P Customer’s contact information.
  - 1.4 “P/P Provider” or “Service Provider” is the provider of Privacy/Proxy Services, including Registrar and its Affiliates, as applicable.
2. Obligations of Registrar. For any Proxy Service or Privacy Service offered by the Registrar or its Affiliates (including through a Reseller), and used in connection with Registered Names Sponsored by the Registrar, the Registrar and its Affiliates and Resellers must require all P/P Providers to follow the requirements described in this Specification and to abide by the terms and procedures published pursuant to this Specification.
  - 2.1 Disclosure of Service Terms. P/P Provider shall publish the terms and conditions of its service (including pricing), on its website and/or Registrar’s website.
  - 2.2 Abuse/Infringement Point of Contact. P/P Provider shall publish a point of contact for third parties wishing to report abuse or infringement of trademarks (or other rights).

- 2.3 Disclosure of Identity of P/P Provider. P/P Provider shall publish its business contact information on its website and/or Registrar's website.
- 2.4 Terms of service and description of procedures. The P/P Provider shall publish on its website and/or Registrar's website a copy of the P/P Provider service agreement and description of P/P Provider's procedures for handling the following:
  - 2.4.1 The process or facilities to report abuse of a domain name registration managed by the P/P Provider;
  - 2.4.2 The process or facilities to report infringement of trademarks or other rights of third parties;
  - 2.4.3 The circumstances under which the P/P Provider will relay communications from third parties to the P/P Customer;
  - 2.4.4 The circumstances under which the P/P Provider will terminate service to the P/P Customer;
  - 2.4.5 The circumstances under which the P/P Provider will reveal and/or publish in the Registration Data Service (Whois) or equivalent service the P/P Customer's identity and/or contact data; and
  - 2.4.6 A description of the support services offered by P/P Providers to P/P Customers, and how to access these services.
- 2.5 Escrow of P/P Customer Information. Registrar shall include P/P Customer contact information in its Registration Data Escrow deposits required by Section 3.6 of the Agreement. P/P Customer Information escrowed pursuant to this Section 2.5 of this Specification may only be accessed by ICANN in the event of the termination of the Agreement or in the event Registrar ceases business operations.
3. Exemptions. Registrar is under no obligation to comply with the requirements of this specification if it can be shown that:
  - 3.1 Registered Name Holder employed the services of a P/P Provider that is not provided by Registrar, or any of its Affiliates;
  - 3.2 Registered Name Holder licensed a Registered Name to another party (i.e., is acting as a Proxy Service) without Registrar's knowledge; or
  - 3.3 Registered Name Holder has used P/P Provider contact data without subscribing to the service or accepting the P/P Provider terms and conditions.

## SPECIFICATION ON PRIVACY AND PROXY REGISTRATIONS

Until the earlier to occur of (i) January 1, 2017, and (ii) the date ICANN establishes and implements a Privacy and Proxy Accreditation Program as referenced in Section 3.14 of the Registrar Accreditation Agreement, Registrar agrees to comply, and to require its Affiliates and Resellers to comply, with the terms of this Specification, provided that ICANN and the Working Group may mutually agree to extend the term of this Specification. This Specification may not be modified by ICANN or Registrar.

1. Definitions. For the purposes of this Specification, the following definitions shall apply.
  - 1.1 “P/P Customer” means, regardless of the terminology used by the P/P Provider, the licensee, customer, beneficial user, beneficiary, or other recipient of Privacy Services and Proxy Services.
  - 1.2 “Privacy Service” is a service by which a Registered Name is registered to its beneficial user as the Registered Name Holder, but for which alternative, reliable contact information is provided by the P/P Provider for display of the Registered Name Holder’s contact information in the Registration Data Service (Whois) or equivalent services.
  - 1.3 “Proxy Service” is a service through which a Registered Name Holder licenses use of a Registered Name to the P/P Customer in order to provide the P/P Customer use of the domain name, and the Registered Name Holder’s contact information is displayed in the Registration Data Service (Whois) or equivalent services rather than the P/P Customer’s contact information.
  - 1.4 “P/P Provider” or “Service Provider” is the provider of Privacy/Proxy Services, including Registrar and its Affiliates, as applicable.
2. Obligations of Registrar. For any Proxy Service or Privacy Service offered ~~through~~by the Registrar or its Affiliates (including through a Reseller), and used in connection with Registered Names Sponsored by the Registrar, the Registrar and its Affiliates and Resellers must require all P/P Providers to follow the requirements described in this Specification and to abide by the terms and procedures published pursuant to this Specification.
  - 2.1 Disclosure of Service Terms. P/P Provider shall publish the terms and conditions of its service (including pricing), on its website and/or Registrar’s website.
  - 2.2 Abuse/Infringement Point of Contact. P/P Provider shall publish a point of contact for third parties wishing to report abuse or infringement of trademarks (or other rights).

- 2.3 Disclosure of Identity of P/P Provider. P/P Provider shall publish its business contact information on its website and/or Registrar's website.
- 2.4 Terms of service and description of procedures. The P/P Provider shall publish on its website and/or Registrar's website a copy of the P/P Provider service agreement and description of P/P Provider's procedures for handling the following:
  - 2.4.1 The process or facilities to report abuse of a domain name registration managed by the P/P Provider;
  - 2.4.2 The process or facilities to report infringement of trademarks or other rights of third parties;
  - 2.4.3 The circumstances under which the P/P Provider will relay communications from third parties to the P/P Customer;
  - 2.4.4 The circumstances under which the P/P Provider will terminate service to the P/P Customer;
  - 2.4.5 The circumstances under which the P/P Provider will reveal and/or publish in the Registration Data Service (Whois) or equivalent service the P/P Customer's identity and/or contact data; and
  - 2.4.6 A description of the support services offered by P/P Providers to P/P Customers, and how to access these services.
- 2.5 Escrow of P/P Customer Information. Registrar shall include P/P Customer contact information in its Registration Data Escrow deposits required by Section 3.6 of the Agreement. P/P Customer Information escrowed pursuant to this Section 2.5 of this Specification may only be accessed by ICANN in the event of the termination of the Agreement or in the event Registrar ceases business operations.
3. Exemptions. Registrar is under no obligation to comply with the requirements of this specification if it can be shown that:
  - 3.1 Registered Name Holder employed the services of a P/P Provider that is not provided by Registrar, or any of its Affiliates;
  - 3.2 Registered Name Holder licensed a Registered Name to another party (i.e., is acting as a Proxy Service) without Registrar's knowledge; or
  - 3.3 Registered Name Holder has used P/P Provider contact data without subscribing to the service or accepting the P/P Provider terms and conditions.



<b>Summary Report:</b>	
<b>Litera Change-Pro ML IC 6.5.0.313 Document Comparison done on 6/20/2013 5:00:16 PM</b>	
<b>Style Name:</b> JD Color With Moves	
<b>Original Filename:</b>	
<b>Original DMS:</b> iw://IRI/IRI/49580/4	
<b>Modified Filename:</b>	
<b>Modified DMS:</b> iw://IRI/IRI/49580/5	
<b>Changes:</b>	
<u>Add</u>	4
<del>Delete</del>	3
<del>Move From</del>	0
<u>Move To</u>	0
<u>Table Insert</u>	0
<del>Table Delete</del>	0
Embedded Graphics (Visio, ChemDraw, Images etc.)	0
Embedded Excel	0
<b>Total Changes:</b>	<b>7</b>

## **DATA RETENTION SPECIFICATION**

1. During the Term of this Agreement, for each Registered Name sponsored by Registrar within a gTLD, Registrar shall collect and securely maintain in its own electronic database (as updated from time to time) the data specified below:
  - 1.1. Registrar shall collect the following information from registrants at the time of registration of a domain name (a “Registration”) and shall maintain that information for the duration of Registrar’s sponsorship of the Registration and for a period of two additional years thereafter:
    - 1.1.1. First and last name or full legal name of registrant;
    - 1.1.2. First and last name or, in the event registrant is a legal person, the title of the registrant’s administrative contact, technical contact, and billing contact;
    - 1.1.3. Postal address of registrant, administrative contact, technical contact, and billing contact;
    - 1.1.4. Email address of registrant, administrative contact, technical contact, and billing contact;
    - 1.1.5. Telephone contact for registrant, administrative contact, technical contact, and billing contact;
    - 1.1.6. WHOIS information, as set forth in the WHOIS Specification;
    - 1.1.7. Types of domain name services purchased for use in connection with the Registration; and
    - 1.1.8. To the extent collected by Registrar, “card on file,” current period third party transaction number, or other recurring payment data.
  - 1.2. Registrar shall collect the following information and maintain that information for no less than one hundred and eighty (180) days following the relevant interaction:
    - 1.2.1. Information regarding the means and source of payment reasonably necessary for the Registrar to process the Registration transaction, or a transaction number provided by a third party payment processor;
    - 1.2.2. Log files, billing records and, to the extent collection and maintenance of such records is commercially practicable or consistent with industry-wide generally accepted standard practices within the industries in which Registrar operates, other records containing communications source and destination information, including, depending on the method of transmission and without limitation: (1) Source IP address, HTTP

headers, (2) the telephone, text, or fax number; and (3) email address, Skype handle, or instant messaging identifier, associated with communications between Registrar and the registrant about the Registration; and

- 1.2.3. Log files and, to the extent collection and maintenance of such records is commercially practicable or consistent with industry-wide generally accepted standard practices within the industries in which Registrar operates, other records associated with the Registration containing dates, times, and time zones of communications and sessions, including initial registration.
2. If, based on the receipt of either (i) a written legal opinion from a nationally recognized law firm in the applicable jurisdiction that states that the collection and/or retention of any data element specified herein by Registrar is reasonably likely to violate applicable law (the “Opinion”) or (ii) a ruling of, or written guidance from, a governmental body of competent jurisdiction providing that compliance with the data collection and/or retention requirements of this Specification violates applicable law, Registrar determines in good faith that the collection and/or retention of any data element specified in this Specification violates applicable law, Registrar may provide written notice of such determination to ICANN and request a waiver from compliance with specific terms and conditions of this Specification (a “Waiver Request”). Such written notice shall: (i) specify the relevant applicable law, the allegedly offending data collection and retention elements, the manner in which the collection and/or retention of such data violates applicable law, and a reasonable description of such determination and any other facts and circumstances related thereto, (ii) be accompanied by a copy of the Opinion and governmental ruling or guidance, as applicable, and (iii) be accompanied by any documentation received by Registrar from any governmental authority, in each case, related to such determination, and such other documentation reasonably requested by ICANN. Following receipt of such notice, ICANN and Registrar shall discuss the matter in good faith in an effort to reach a mutually acceptable resolution of the matter. Until such time as ICANN’s Procedure for Handling Whois Conflicts with Privacy Law is modified to include conflicts relating to the requirements of this Specification and if ICANN agrees with Registrar’s determination, ICANN’s office of general counsel may temporarily or permanently suspend compliance and enforcement of the affected provisions of this Specification and grant the Wavier Request. Prior to granting any exemption hereunder, ICANN will post its determination on its website for a period of thirty (30) calendar days. Following such modification of ICANN’s Procedure for Handling Whois Conflicts with Privacy Law, all Wavier Requests (whether granted or denied) shall be resolved pursuant to such modified procedures.
3. If (i) ICANN has previously waived compliance with the requirements of any requirement of this Data Retention Specification in response to a Waiver Request from a registrar that is located in the same jurisdiction as Registrar and (ii) Registrar is subject to the same applicable law that gave rise to ICANN’s agreement to grant such wavier, Registrar may request that ICANN to grant a similar waiver, which



request shall be approved by ICANN, unless ICANN provides Registrar with a reasonable justification for not approving such request, in which case Registrar may thereafter make an Waiver Request pursuant to Section 2 of this Data Retention Specification.

4. Any modification of this Data Retention Specification to address violations of applicable law shall only apply during the period of time that the specific provisions of the applicable law giving rise to such violations remain in effect. If the applicable law is repealed or modified (or preempted) in a manner that would no longer prohibit the collection and/or retention of data and information as originally specified in this Data Retention Specification, Registrar agrees that the original version of this Specification will apply to the maximum extent permitted by such modified applicable law.

## **REGISTRAR INFORMATION SPECIFICATION**

Registrar shall provide to ICANN the information specified below, which shall be maintained in accordance with Section 3.17 of the Agreement. With regard to information identified below, ICANN will hold such information pursuant to the disclosure requirements set forth in Section 3.15 of the Agreement.

### **General Information**

1. Full legal name of Registrar.
2. Legal form of the Registrar (e.g., LLC, Corporation, Government Body, Intergovernmental Organization, etc.).
3. The jurisdiction in which the Registrar's business is registered for legal and financial purposes.
4. The Registrar's business registration number and the name of the authority that issued this number.
5. Every business name and/or trade name used by the Registrar.
6. Provide current documentation demonstrating that the Registrar entity is legally established and in good standing. For proof of establishment, provide charter documents or other equivalent document (e.g., membership agreement) of the entity. If the Registrar is a government body or organization, provide a certified copy of the relevant statute, governmental decision or other instrument under which the government body or organization has been established. With respect to an entity other than a government body or organization, where no such certificates or documents are available in the Registrar's jurisdiction, an affidavit drafted and signed by a notary public or a legal practitioner duly qualified in the courts of the Registrar's jurisdiction, declaring that the organization is established and in good standing, must be provided.
7. Correspondence address for the Registrar.\* This address will be used for contractual purposes, and the Registrar must be able to accept notices and service of legal process at this address. No Post Office boxes are allowed.
8. Primary phone number where the Registrar can be reached for contractual purposes.
9. Primary Fax number where the Registrar can be reached for contractual purposes.
10. Primary Email address where the Registrar can be reached for contractual purposes.

\* Must also be published on Registrar's website.

11. If the location or address of Registrar’s principal place of business is different from the address provided in 7, provide details including address, phone number, fax number and email address.\* Provide ICANN with current documentation demonstrating that the Registrar is legally entitled to do business in the principal place of business.

12. Any other addresses where the Registrar will be operated or managed, if different from either its principal place of business or correspondence address provided above. (If so, please explain.) Provide ICANN with current documentation demonstrating that the Registrar is legally entitled to do business in each location identified.

13. Primary contact name:

- Title
- Address
- Phone number
- Fax number
- Email address

14. URL and Location of Port 43 WHOIS server.

**Ownership, Directors and Officers Information**

15. Full name, contact information, and position of any persons or entities owning at least 5% of the ownership interest in Registrar’s current business entity. For each person listed, please specify such person’s percentage ownership.

16. Full name, contact information, and position of all directors of the Registrar.

17. Full name, contact information, and position of all officers of the Registrar.\* (Officer names and positions must be publicly displayed.)

18. Full name, contact information, and position of all senior management and other key personnel overseeing the provision of Registrar Services.

19. For every person or entity mentioned in the answers to questions 15 to 18, indicate if that person or entity:

- a) within the past ten years, has been convicted of a felony or of a misdemeanor related to financial activities, or has been judged by a court to have committed fraud or breach of fiduciary duty, or has been the subject of a judicial determination that is similar or related to any of these;
- b) within the past ten years, has been disciplined by any government or industry regulatory body for conduct involving dishonesty or misuse of funds of others;

\* Must also be published on Registrar’s website.

c) is currently involved in any judicial or regulatory proceeding that could result in a conviction, judgment, determination, or discipline of the type specified in items 19(a) or 19(b); or

d) is the subject of a disqualification imposed by ICANN.

Provide details if any of the above events in (a)-(d) have occurred.

20. List all Affiliated Registrars, if any, and briefly describe the Affiliation.
21. For any entities listed in item 20, must provide information required in items 1-14 above.
22. List the ultimate parent entity of the Registrar, if applicable.\*

**Other**

23. Does the Registrar or any of its Affiliates offer any Privacy Service or Proxy Service (as such terms on defined in the Specification on Privacy and Proxy Registrations)? If yes, list the entities or individuals providing the Privacy Service or Proxy Service.
24. For any entities listed in item 20, provide information required in 1-14 above.
25. Does the Registrar utilize or benefit from the services of Resellers?
26. If yes, provide a list of all such Resellers known to Registrar. The information specified in this item 26 shall be made available to ICANN upon request. At such time as ICANN develops a secure method for the receipt and retention of such information, such information shall thereafter be provided to ICANN in accordance with Section 3.17 of the Agreement.

\* Must also be published on Registrar's website.

## ADDITIONAL REGISTRAR OPERATION SPECIFICATION

This Specification may be modified by ICANN from time to time after consultation with the Registrar Stakeholder Group (or its successor), provided that such updates are commercially practical with respect to the registrar industry, taken as a whole.

### 1. DNSSEC

Registrar must allow its customers to use DNSSEC upon request by relaying orders to add, remove or change public key material (e.g., DNSKEY or DS resource records) on behalf of customers to the Registries that support DNSSEC. Such requests shall be accepted and processed in a secure manner and according to industry best practices. Registrars shall accept any public key algorithm and digest type that is supported by the TLD of interest and appears in the registries posted at: <http://www.iana.org/assignments/dns-sec-alg-numbers/dns-sec-alg-numbers.xml> and <http://www.iana.org/assignments/ds-rr-types/ds-rr-types.xml>. All such requests shall be transmitted to registries using the EPP extensions specified in RFC 5910 or its successors.

### 2. IPv6

To the extent that Registrar offers registrants the ability to register nameserver addresses, Registrar must allow both IPv4 addresses and IPv6 addresses to be specified.

### 3. IDN

If the Registrar offers Internationalized Domain Name (“IDN”) registrations, all new registrations must comply with RFCs 5890, 5891, 5892, 5893 and their successors. Registrar shall also comply with the IDN Guidelines at <http://www.icann.org/en/topics/idn/implementation-guidelines.htm> which may be amended, modified, or superseded from time to time. Registrar must use the IDN tables published by the relevant registry.

## ***Registrants' Contractual Rights and Responsibilities***

### **Domain Name Registrants' Rights:**

1. Your domain name registration and any privacy/proxy services you may use in conjunction with it must be subject to a Registration Agreement with an ICANN Accredited Registrar.
  - You are entitled to review this Registration Agreement at any time, and download a copy for your records.
2. You are entitled to accurate and accessible information about:
  - The identity of your ICANN Accredited Registrar;
  - The identity of any proxy or privacy service provider affiliated with your Registrar;
  - Your Registrar's terms and conditions, including pricing information, applicable to domain name registrations;
  - The terms and conditions, including pricing information, applicable to any privacy services offered by your Registrar;
  - The customer support services offered by your Registrar and the privacy services provider, and how to access them;
  - How to raise concerns and resolve disputes with your Registrar and any privacy services offered by them; and
  - Instructions that explain your Registrar's processes for registering, managing, transferring, renewing, and restoring your domain name registrations, including through any proxy or privacy services made available by your Registrar.
3. You shall not be subject to false advertising or deceptive practices by your Registrar or through any proxy or privacy services made available by your Registrar. This includes deceptive notices, hidden fees, and any practices that are illegal under the consumer protection law of your residence.

### **Domain Name Registrants' Responsibilities:**

1. You must comply with the terms and conditions posted by your Registrar, including applicable policies from your Registrar, the Registry and ICANN.
2. You must review your Registrar's current Registration Agreement, along with any updates.
3. You will assume sole responsibility for the registration and use of your domain name.
4. You must provide accurate information for publication in directories such as WHOIS, and promptly update this to reflect any changes.
5. You must respond to inquiries from your Registrar within fifteen (15) days, and keep your Registrar account data current. If you choose to have your domain name registration renew automatically, you must also keep your payment information current.

## **Registrants' Contractual Rights and Responsibilities**

### **Domain Name Registrants' Rights:**

1. Your domain name registration and any privacy/proxy services you may use in conjunction with it must be subject to a Registration Agreement with an ICANN Accredited Registrar.
  - You are entitled to review this Registration Agreement at any time, and download a copy for your records.
2. You are entitled to accurate and accessible information about:
  - The identity of your ICANN Accredited Registrar;
  - The identity of any proxy or privacy service provider affiliated with your Registrar;
  - Your Registrar's terms and conditions, including pricing information, applicable to domain name registrations;
  - The terms and conditions, including pricing information, applicable to any privacy services offered by your Registrar;
  - The customer support services offered by your Registrar and the privacy services provider, and how to access them;
  - How to raise concerns and resolve disputes with your Registrar and any privacy services offered by them; and
  - Instructions that explain your Registrar's processes for registering, managing, transferring, renewing, and restoring your domain name registrations, including through any proxy or privacy services made available by your Registrar.
3. You shall not be subject to false advertising or deceptive practices by your Registrar or through any proxy or privacy services made available by your Registrar. This includes deceptive notices, hidden fees, and any practices that are illegal under the consumer protection law of your residence.

### **Domain Name Registrants' Responsibilities:**

1. You must comply with the terms and conditions posted by your Registrar, including applicable policies from your Registrar, the Registry and ICANN.
2. You must review your Registrar's current Registration Agreement, along with any updates.
3. You will assume sole responsibility for the registration and use of your domain name.
4. You must provide accurate information for publication in directories such as WHOIS, and promptly update this to reflect any changes.
5. You must respond to inquiries from your Registrar within fifteen (15) days, and keep your Registrar account data current. If you choose to have your domain name registration renew automatically, you must also keep your payment information current.

<b>Summary Report:</b>	
<b>Litera Change-Pro ML IC 6.5.0.313 Document Comparison done on 6/19/2013 5:23:04 PM</b>	
<b>Style Name:</b> JD Color With Moves	
<b>Original Filename:</b>	
<b>Original DMS:</b> iw://IRI/IRI/48775/2	
<b>Modified Filename:</b>	
<b>Modified DMS:</b> iw://IRI/IRI/48775/3	
<b>Changes:</b>	
<u>Add</u>	2
<del>Delete</del>	1
<del>Move From</del>	0
<u>Move To</u>	0
<u>Table Insert</u>	0
<del>Table Delete</del>	0
Embedded Graphics (Visio, ChemDraw, Images etc.)	0
Embedded Excel	0
<b>Total Changes:</b>	<b>3</b>





# LOGO LICENSE SPECIFICATION to RAA (TBD)

## LOGO LICENSE SPECIFICATION

The Internet Corporation for Assigned Names and Numbers, a California non-profit, public benefit corporation ("ICANN"), and [Registrar Name], a [organization type and jurisdiction] ("Registrar") have entered into a Registrar Accreditation Agreement ("Registrar Accreditation Agreement"), of which this appendix ("Logo License Specification") is a part. Definitions in the Registrar Accreditation Agreement apply in this Logo License Specification.

Registrar wishes to acquire from ICANN, and ICANN wishes to grant to Registrar, a license to use the trademarks listed below the signature block of this Logo License Specification ("Trademarks") in connection with Registrar's role as an ICANN-accredited registrar. Pursuant to and subject to the Registrar Accreditation Agreement, Registrar and ICANN hereby agree as follows:

### LICENSE

1. Grant of License. ICANN grants to Registrar a non-exclusive, worldwide right and license to use the Trademarks, during the term of this specification and solely in connection with the provision and marketing of Registrar Services in order to indicate that Registrar is accredited as a registrar of domain names by ICANN. Except as provided in this subsection and Subsection 2.2 of the Registrar Accreditation Agreement, Registrar shall not use the Trademarks, any term, phrase, or design which is confusingly similar to the Trademarks or any portion of the Trademarks in any manner whatsoever.
2. Ownership of Trademarks. Any and all rights in the Trademarks that may be acquired by Registrar shall inure to the benefit of, and are hereby assigned to, ICANN. Registrar shall not assert ownership of the Trademarks or any associated goodwill.
3. No Sublicense. Registrar shall not sublicense any of its rights under this specification to any other person or entity (including any of Registrar's resellers) without the prior written approval of ICANN.

### REGISTRATION AND ENFORCEMENT

1. Registration. Registration and any other form of protection for the Trademarks shall only be obtained by ICANN in its name and at its expense.

2. Enforcement. Registrar shall promptly notify ICANN of any actual or suspected infringement of the Trademarks by third parties, including Registrar's resellers or affiliates. ICANN shall have the sole discretion to initiate and maintain any legal proceedings against such third parties; Registrar shall not take any such actions without the prior written approval of ICANN; and ICANN shall retain any and all recoveries from such actions.

3. Further Assurances. Registrar agrees to execute such other documents and to take all such actions as ICANN may request to effect the terms of this specification, including providing such materials (for example URLs and samples of any promotional materials bearing the Trademarks), cooperation, and assistance as may be reasonably required to assist ICANN in obtaining, maintaining, and enforcing trademark registration(s) and any other form of protection for the Trademarks.

#### TERM AND TERMINATION

This Logo License Specification shall be effective from the date it is signed below by both parties until the Expiration Date, unless this specification or the Registrar Accreditation Agreement is earlier terminated. Each party shall have the right to terminate this specification at any time by giving the other party written notice. Upon expiration or termination of this specification, Registrar shall immediately discontinue all use of the Trademarks.

IN WITNESS WHEREOF, the parties have caused this Logo License Specification to be executed by their duly authorized representatives.

ICANN

[Registrar Name]

By: \_\_\_\_\_

By: \_\_\_\_\_

Name:

Title:

Dated: \_\_\_\_\_, 200\_\_

#### TRADEMARKS:

1. ICANN Accredited Registrar

2.





LOGO LICENSE  
~~APPENDIX~~SPECIFICATION to  
RAA  
(~~21 May 2009~~TBD)

---

LOGO LICENSE ~~APPENDIX~~SPECIFICATION

The Internet Corporation for Assigned Names and Numbers, a California non-profit, public benefit corporation ("ICANN"), and [Registrar Name], a [organization type and jurisdiction] ("Registrar") have entered into a Registrar Accreditation Agreement ("Registrar Accreditation Agreement"), of which this appendix ("~~Logo License~~ ~~Appendix~~Specification") is a part. Definitions in the Registrar Accreditation Agreement apply in this Logo License ~~Appendix~~Specification.

Registrar wishes to acquire from ICANN, and ICANN wishes to grant to Registrar, a license to use the trademarks listed below the signature block of this Logo License ~~Appendix~~Specification ("Trademarks") in connection with Registrar's role as an ICANN-accredited registrar. Pursuant to and subject to the Registrar Accreditation Agreement, Registrar and ICANN hereby agree as follows:

LICENSE

1. Grant of License. ICANN grants to Registrar a non-exclusive, worldwide right and license to use the Trademarks, during the term of this ~~appendix~~specification and solely in connection with the provision and marketing of Registrar Services in order to indicate that Registrar is accredited as a registrar of domain names by ICANN. Except as provided in this subsection and Subsection 2.2 of the Registrar Accreditation Agreement, Registrar shall not use the Trademarks, any term, phrase, or design which is confusingly similar to the Trademarks or any portion of the Trademarks in any manner whatsoever.
2. Ownership of Trademarks. Any and all rights in the Trademarks that may be acquired by Registrar shall inure to the benefit of, and are hereby assigned to, ICANN. Registrar shall not assert ownership of the Trademarks or any associated goodwill.
3. No Sublicense. Registrar shall not sublicense any of its rights under this ~~appendix~~specification to any other person or entity (including any of Registrar's resellers) without the prior written approval of ICANN.

REGISTRATION AND ENFORCEMENT

1. Registration. Registration and any other form of protection for the Trademarks shall only be obtained by ICANN in its name and at its expense.
2. Enforcement. Registrar shall promptly notify ICANN of any actual or suspected infringement of the Trademarks by third parties, including Registrar's resellers or affiliates. ICANN shall have the sole discretion to initiate and maintain any legal proceedings against such third parties; Registrar shall not take any such actions without the prior written approval of ICANN; and ICANN shall retain any and all recoveries from such actions.
3. Further Assurances. Registrar agrees to execute such other documents and to take all such actions as ICANN may request to effect the terms of this [appendixspecification](#), including providing such materials (for example URLs and samples of any promotional materials bearing the Trademarks), cooperation, and assistance as may be reasonably required to assist ICANN in obtaining, maintaining, and enforcing trademark registration(s) and any other form of protection for the Trademarks.

#### TERM AND TERMINATION

This Logo License [AppendixSpecification](#) shall be effective from the date it is signed below by both parties until the Expiration Date, unless this [appendixspecification](#) or the Registrar Accreditation Agreement is earlier terminated. Each party shall have the right to terminate this [appendixspecification](#) at any time by giving the other party written notice. Upon expiration or termination of this [appendixspecification](#), Registrar shall immediately discontinue all use of the Trademarks.

IN WITNESS WHEREOF, the parties have caused this Logo License [AppendixSpecification](#) to be executed by their duly authorized representatives.

ICANN

[Registrar Name]

By: \_\_\_\_\_ By: \_\_\_\_\_

Name:

Title:

Dated: \_\_\_\_\_, 200\_\_

#### TRADEMARKS:

1. ICANN Accredited Registrar
- 2.



<b>Summary Report:</b>	
<b>Litera Change-Pro ML IC 6.5.0.313 Document Comparison done on 6/19/2013 5:54:34 PM</b>	
<b>Style Name:</b> JD Color With Moves	
<b>Original Filename:</b>	
<b>Original DMS:</b> iw://IRI/IRI/39372/2	
<b>Modified Filename:</b>	
<b>Modified DMS:</b> iw://IRI/IRI/39372/3	
<b>Changes:</b>	
<u>Add</u>	14
<del>Delete</del>	17
<del>Move From</del>	0
<u>Move To</u>	0
<u>Table Insert</u>	0
<del>Table Delete</del>	0
Embedded Graphics (Visio, ChemDraw, Images etc.)	0
Embedded Excel	0
<b>Total Changes:</b>	<b>31</b>

**COMPLIANCE CERTIFICATE**

\_\_\_\_\_, 20\_\_

Pursuant to Section 3.15 of Registrar Accreditation Agreement (the "Agreement"), dated \_\_\_\_\_, 20\_\_, by and between the Internet Corporation for Assigned Names and Numbers, a California non-profit, public benefit corporation ("ICANN"), and [Registrar Name], a [Organization type and jurisdiction] ("Registrar"), the undersigned certifies, in his/her capacity as an officer of the Registrar and not in his/her individual capacity, on behalf of Registrar as follows:

1. The undersigned is the [Chief Executive Officer/President/Chief Operating Officer/Chief Financial Officer or functional equivalent thereof] of Registrar.

2. Registrar has in place processes and procedures intended to establish, maintain, review, test, and modify registrar policies and procedures reasonably designed to achieve compliance with the Agreement.

3. To the best of the undersigned's knowledge and belief, Registrar has performed and complied with all covenants, agreements, obligations and conditions contained in the Agreement that are required to be performed or complied with by it for the calendar year 20\_\_.

The undersigned signs this certificate as of the date indicated under the title.

**[REGISTRAR]**

By: \_\_\_\_\_

Name:

Title:



## Transition Addendum to Registrar Accreditation Agreement

This Transition Addendum (this "Addendum") to the Registrar Accreditation Agreement (the "Agreement") by and between the Internet Corporation for Assigned Names and Numbers, a California non-profit, public benefit corporation ("ICANN"), and [Registrar Name], a [Organization type and jurisdiction] ("Registrar"), is dated as of \_\_\_\_\_, 2013.

**WHEREAS**, ICANN and Registrar entered into the Agreement as of the date hereof; and

**WHEREAS**, ICANN acknowledges that implementation by Registrar of certain operational provisions of the Agreement is not possible on the date hereof and will require a reasonable grace period.

**NOW THEREFORE**, the parties agree as follows:

1. ICANN will not enforce the following provisions and specifications of the Agreement until January 1, 2014: Sections 3.4.1.1, 3.4.1.5, 3.7.10, 3.7.11, 3.12.4, 3.12.7, 3.14, 3.18 and 3.19 of the Agreement; the first sentence of Section 3.7.8 of the Agreement; the WHOIS Accuracy Specification; the Data Retention Specification; and the service level agreements set forth in Section 2.2 of the Registration Data Directory Service (WHOIS) Specification (collectively, the "Transition Provisions").
2. In addition, if immediately prior to the execution of this Addendum Registrar was party to the form registrar accreditation agreement adopted by ICANN in 2009 (the "2009 RAA"), Registrar may use its existing form of registrant registration agreement until January 1, 2014, provided that such agreement complies with Section 3.7.7 of the 2009 RAA.
3. For the calendar year ended December 31, 2013, any certification required pursuant to Section 3.15 shall not require certification as to compliance with the Transition Provisions and may acknowledge the permissible use of the registrant registration agreement under Section 2 hereof.
4. Notwithstanding the foregoing, Registrar agrees to use commercially reasonable efforts to comply with the obligations set forth in the Transition Provisions and transition to a registrant registration agreement that complies with the terms of the Agreement prior to January 1, 2014.
5. Registrar must be fully compliant with the Transition Provisions and Section 3.7.7 of the Agreement as of January 1, 2014, at which date this Addendum shall automatically terminate without action by any party, except as it relates to Section 4 hereof.
6. ICANN and an advisory panel of registrars will work together to identify and specify an appropriate set of tools to enable Registrar to complete the across field validation specified in Section 1(e) of the Whois Accuracy Program Specification to the Agreement (the "Across Field Validation"). When ICANN and the advisory panel determine that such tools are technically and commercially available, ICANN shall provide Registrar written notice of

such determination (which notice shall specify and describe the identified tools). Effective on the one hundred eightieth (180<sup>th</sup>) calendar day following delivery of such notice by ICANN, Registrar shall comply with the obligations specified in Section 1(e) of the Whois Accuracy Program. Until such time, ICANN will not enforce compliance with such requirements.

7. Except as set forth in this Addendum, the Agreement shall be in full force and effect, enforceable by the parties in accordance with its terms.

[signature page follows]

IN WITNESS WHEREOF, the parties hereto have caused this Addendum to be executed in duplicate by their duly authorized representatives.

**ICANN**

**[Registrar]**

By: \_\_\_\_\_

By: \_\_\_\_\_

Name: \_\_\_\_\_

Name: \_\_\_\_\_

Title: \_\_\_\_\_

Title: \_\_\_\_\_

## Transition Addendum to Registrar Accreditation Agreement

This Transition Addendum (this "Addendum") to the Registrar Accreditation Agreement (the "Agreement") by and between the Internet Corporation for Assigned Names and Numbers, a California non-profit, public benefit corporation ("ICANN"), and [Registrar Name], a [Organization type and jurisdiction] ("Registrar"), is dated as of \_\_\_\_\_, 2013.

**WHEREAS**, ICANN and Registrar entered into the Agreement as of the date hereof; and

**WHEREAS**, ICANN acknowledges that implementation by Registrar of certain operational provisions of the Agreement is not possible on the date hereof and will require a reasonable grace period.

**NOW THEREFORE**, the parties agree as follows:

1. ICANN will not enforce the following provisions and specifications of the Agreement until January 1, 2014: Sections 3.4.1.1, 3.4.1.5, 3.7.10, 3.7.11, 3.12.4, 3.12.7, 3.14, 3.18 and 3.19 of the Agreement; the first sentence of Section 3.7.8 of the Agreement; the WHOIS Accuracy Specification; the Data Retention Specification; and the service level agreements set forth in Section 2.2 of the Registration Data Directory Service (WHOIS) Specification (collectively, the "Transition Provisions").
2. In addition, if immediately prior to the execution of this Addendum Registrar was party to the form registrar accreditation agreement adopted by ICANN in 2009 (the "2009 RAA"), Registrar may use its existing form of registrant registration agreement until January 1, 2014, provided that such agreement complies with Section 3.7.7 of the 2009 RAA.
3. For the calendar year ended December 31, 2013, any certification required pursuant to Section 3.15 shall not require certification as to compliance with the Transition Provisions and may acknowledge the permissible use of the registrant registration agreement under Section 2 hereof.
4. Notwithstanding the foregoing, Registrar agrees to use commercially reasonable efforts to comply with the obligations set forth in the Transition Provisions and transition to a registrant registration agreement that complies with the terms of the Agreement prior to January 1, 2014.
5. Registrar must be fully compliant with the Transition Provisions and Section 3.7.7 of the Agreement as of January 1, 2014, at which date this Addendum shall automatically terminate without action by any party, except as it relates to Section 4 hereof.
6. ICANN and ~~the Working Group (as defined in the Agreement)~~ an advisory panel of registrars will work together to identify and specify an appropriate set of tools to enable Registrar to complete the across field validation specified in Section 1(e) of the Whois Accuracy Program Specification to the Agreement (the "Across Field Validation"). When ~~such tools are mutually agreed between~~ ICANN and the ~~Working Group~~ advisory panel

determine that such tools are technically and commercially available, ICANN shall provide Registrar written notice of such ~~agreement~~determination (which notice shall specify and describe the ~~agreed-upon~~identified tools). Effective on the one hundred eightieth (180<sup>th</sup>) calendar day following delivery of such notice by ICANN, Registrar shall comply with the obligations specified in Section 1(e) of the Whois Accuracy Program. Until such time, ICANN will not enforce compliance with such requirements.

7. Except as set forth in this Addendum, the Agreement shall be in full force and effect, enforceable by the parties in accordance with its terms.

[signature page follows]

IN WITNESS WHEREOF, the parties hereto have caused this Addendum to be executed in duplicate by their duly authorized representatives.

**ICANN**

**[Registrar]**

By: \_\_\_\_\_

By: \_\_\_\_\_

Name: \_\_\_\_\_

Name: \_\_\_\_\_

Title: \_\_\_\_\_

Title: \_\_\_\_\_

<b>Summary Report:</b>	
<b>Litera Change-Pro ML IC 6.5.0.313 Document Comparison done on 6/20/2013 4:53:17 PM</b>	
<b>Style Name:</b> JD Color With Moves	
<b>Original Filename:</b>	
<b>Original DMS:</b> iw://IRI/IRI/47768/4	
<b>Modified Filename:</b>	
<b>Modified DMS:</b> iw://IRI/IRI/47768/5	
<b>Changes:</b>	
<u>Add</u>	4
<del>Delete</del>	7
<del>Move From</del>	0
<u>Move To</u>	0
<u>Table Insert</u>	0
<del>Table Delete</del>	0
Embedded Graphics (Visio, ChemDraw, Images etc.)	0
Embedded Excel	0
<b>Total Changes:</b>	<b>11</b>

# 2013-06-27-02c-Ref Mat-Attachment C-2013 RAA.pdf



## Summary of Changes to Draft Registrar Accreditation Agreement

The table below sets forth a summary of the changes made to the draft Registrar Accreditation Agreement (RAA) in response to public comments, compared to the draft posted by ICANN in April 2013. Additions are reflected in bold double underline and deletions are reflected in strikethrough. These changes reflect, among other things, responses to public comments received. Note that non-substantive and stylistic changes to the draft agreement are not reflected in the below table.

Section	Change to Text	Change and Rationale
1.1	<u><a href="#">1.1</a></u> <u><a href="#">“Account Holder Paying for the Registered Name” means the person or entity that is paying for the Registered Name, when that person or entity is not the Registered Name Holder.</a></u>	Definition created in response to public comments.
1.5	<u><a href="#">1.5</a></u> <u><a href="#">“Applicable Registrar Family” means, with respect to Affiliated Registrars, such Affiliated Registrar as a group.</a></u>	In response to public comments, defined term was moved from Section 6.10 to consolidate all definitions, to the extent practicable, under a single section of the RAA.
1.18	<p><u><a href="#">1.18</a></u> <u><a href="#">“Registrar Approval” means the receipt of either of the following approvals:</a></u></p> <p><u><a href="#">1.18.1</a></u> <u><a href="#">The affirmative approval of Applicable Registrars accounting for 90% of the Total Registered Names Under Management by the Applicable Registrars; provided that, for purposes of calculating the Total Registered Names Under Management by Applicable Registrars, the Total Registered Names Under Management by each Applicable Registrar Family shall not exceed the Total Registered Names Under Management of the Applicable Registrar Family that is the fifth largest Applicable Registrar Family (measured by number of Registered Names Under Management), both for purposes of the numerator and the denominator; or</a></u></p> <p><u><a href="#">1.18.2</a></u> <u><a href="#">The affirmative approval of 50% plus one of the Applicable Registrars that participate in the process to approve or disapprove (i.e. vote for or against, but not abstain or otherwise fail to vote) a proposed amendment under Section 6, and the affirmative approval of Applicable Registrars accounting for 66.67% of the Total Registered Names Under</a></u></p>	In response to public comments, defined term was moved from Section 6.10 to consolidate all definitions, to the extent practicable, under a single section of the RAA.

Section	Change to Text	Change and Rationale
	<p><u>Management by all Applicable Registrars; provided that, for purposes of calculating the Total Registered Names Under Management by Applicable Registrars, the Total Registered Names Under Management by each Applicable Registrar Family shall not exceed the total Registered Names Under Management of the Applicable Registrar Family that is the fifth largest Applicable Registrar Family (measured by number of Registered Names Under Management), both for purposes of the numerator and the denominator. An example of these calculations is set forth in Appendix 1 attached hereto.</u></p>	
Former 1.2.1	<p><del>1.21 A Registered Name is "sponsored" by the registrar that placed the record associated with that registration into the registry. Sponsorship of a registration may be changed at the express direction of the Registered Name Holder or, in the event a registrar loses Accreditation, in accordance with then-current ICANN Specifications and Policies.</del></p>	Defined term moved to Section 1.26, as a result of adding additional defined terms.
1.25	<p><u>1.25 "Restricted Amendment" means (i) an amendment of the Consensus Policies and Temporary Policies Specification or (ii) the term of this Agreement as specified in Section 5.1, as such term may be extended pursuant to Section 5.2.</u></p>	In response to public comments, defined term was moved from Section 6.10 to consolidate all definitions, to the extent practicable, under a single section of the RAA.
1.26	<p><u>1.26 A Registered Name is "sponsored" by the registrar that placed the record associated with that registration into the registry. Sponsorship of a registration may be changed at the express direction of the Registered Name Holder or, in the event a registrar loses Accreditation, in accordance with then-current ICANN Specifications and Policies.</u></p>	Defined term moved from former Section 1.21, as a result of adding additional defined terms.
1.29	<p><u>1.29 "Total Registered Names Under Management" means the total number of Registered Names sponsored by all Applicable Registrars as reflected in the latest monthly reports submitted to ICANN by Registrars.</u></p>	In response to public comments, defined term was moved from Section 6.10 to consolidate all definitions, to the extent practicable, under a single section of the RAA.
1.32	<p><u>1.32 "Working Group" means representatives of the Applicable Registrars and other members of the community that the Registrar Stakeholder</u></p>	In response to public comments, defined term was moved from Section 6.10 to consolidate all

Section	Change to Text	Change and Rationale
	<p><u>Group appoints, from time to time, to serve as a working group to consult on amendments to the Applicable Registrar Agreements (excluding bilateral amendments pursuant to Section 6.9).</u></p>	<p>definitions, to the extent practicable, under a single section of the RAA.</p>
<p>3.2.1</p>	<p>3.2.1 As part of its registration of Registered Names in a gTLD, Registrar shall submit to, or shall place in the Registry Database operated by, the Registry Operator for the gTLD the following data elements:</p> <p style="padding-left: 40px;">3.2.1.1 The name of the Registered Name being registered;</p> <p style="padding-left: 40px;">3.2.1.2 The IP addresses of the primary nameserver and secondary nameserver(s) for the Registered Name;</p> <p style="padding-left: 40px;">3.2.1.3 The corresponding names of those nameservers;</p> <p style="padding-left: 40px;">3.2.1.4 Unless automatically generated by the registry system, the identity of the Registrar;</p> <p style="padding-left: 40px;">3.2.1.5 Unless automatically generated by the registry system, the expiration date of the registration; and</p> <p style="padding-left: 40px;">3.2.1.6 Any other data the Registry Operator requires be submitted to it.</p> <p>The agreement between the Registry Operator of a gTLD and Registrar may, if approved by ICANN in writing, state alternative required data elements applicable to that gTLD, in which event, the alternative required data elements shall replace and supersede Subsections 3.2.1.1 through 3.2.1.6 stated above for all purposes under this Agreement but only with respect to that particular gTLD.</p> <p><u>When seeking approval for alternative required data elements, the data elements set forth in Subsections 3.2.1.1 through 3.2.1.6 should be considered suggested</u></p>	<p>In response to public comment, revised text clarifies that the specified requirements are the recommended minimum requirements that must be present.</p>

Section	Change to Text	Change and Rationale
	<a href="#">minimum requirements.</a>	
3.7.10	3.7.10 Registrar shall publish on its website(s) and/or provide a link to the Registrants' <a href="#">Contractual</a> Rights and Responsibilities Specification attached hereto and shall not take any action inconsistent with the corresponding provisions of this Agreement or applicable law.	Edit reflects change in the name of the referenced specification, to address community concern over the purpose of the document.
3.12.7	3.12.7 Its Resellers shall publish on their website(s) and/or provide a link to the Registrants' <a href="#">Contractual</a> Rights and Responsibilities Specification attached hereto and shall not take any action inconsistent with the corresponding provisions of this Agreement or applicable law.	Edit reflects change in the name of the referenced specification, to address community concern over the purpose of the document.
6.4	6.4 If the ICANN Board of Directors reasonably determines that a Rejected Amendment falls within the subject matter categories set forth in Section 1.2 of <a href="#">the Consensus Policies and Temporary Policies</a> Specification <del>4</del> , the ICANN Board of Directors may adopt a resolution (the date such resolution is adopted is referred to herein as the "Resolution Adoption Date") requesting an Issue Report (as such term is defined in ICANN's Bylaws) by the Generic Names Supporting Organization (the "GNSO") regarding the substance of such Rejected Amendment. The policy development process undertaken by the GNSO pursuant to such requested Issue Report is referred to herein as a "PDP." If such PDP results in a Final Report supported by a GNSO Supermajority (as defined in ICANN's Bylaws) that either (i) recommends adoption of the Rejected Amendment as Consensus Policy or (ii) recommends against adoption of the Rejected Amendment as Consensus Policy, and, in the case of (i) above, the Board adopts such Consensus Policy, Registrar shall comply with its obligations pursuant to Section 4 of this Agreement. In either case, ICANN will abandon the Rejected Amendment and it will have no effect on the terms and conditions of this Agreement. Notwithstanding the foregoing provisions of this Section 6.4, the ICANN Board of Directors shall not be required to initiate a PDP with respect to a Rejected Amendment if, at any time in the twelve (12) month period preceding the submission of	Edit references the appropriate specification, in response to public comment calling for clear identification of specifications.

Section	Change to Text	Change and Rationale
	such Rejected Amendment for Registrar Approval pursuant to Section 6.3, the subject matter of such Rejected Amendment was the subject of a concluded or otherwise abandoned or terminated PDP that did not result in a GNSO Supermajority recommendation.	
6.5	6.5 If (i) a Rejected Amendment does not fall within the subject matter categories set forth in Section 1.2 of <a href="#">the Consensus Policies and Temporary Policies</a> Specification 4, (ii) the subject matter of a Rejected Amendment was, at any time in the twelve (12) month period preceding the submission of such Rejected Amendment for Registrar Approval pursuant to Section 6.3, the subject of a concluded or otherwise abandoned or terminated PDP that did not result in a GNSO Supermajority recommendation, or (iii) a PDP does not result in a Final Report supported by a GNSO Supermajority that either (a) recommends adoption of the Rejected Amendment as Consensus Policy or (b) recommends against adoption of the Rejected Amendment as Consensus Policy (or such PDP has otherwise been abandoned or terminated for any reason), then, in any such case, such Rejected Amendment may still be adopted and become effective in the manner described below. In order for the Rejected Amendment to be adopted, the following requirements must be satisfied:	Edit references the appropriate specification, in response to public comment calling for clear identification of specifications.
Former 6.10	<p><del>6.10 Definitions: For purposes of this Section 6, the following:</del></p> <p><del>6.10.1 "Applicable Registrar Family" means, with respect to Affiliated Registrars, such Affiliated Registrar as a group.</del></p> <p><del>6.10.2 "Registrar Approval" means the receipt of either of the following approvals:</del></p> <p><del>6.10.2.1 The affirmative approval of Applicable Registrars accounting for 90% of the Total Registered Names Under Management by the Applicable Registrars, provided that, for purposes of calculating the Total Registered Names Under Management by Applicable</del></p>	Deleted definitions were moved to Section 1 in response to public comment.



Section	Change to Text	Change and Rationale
	<p><del>Registrars, the Total Registered Names Under Management by each Applicable Registrar Family shall not exceed the Total Registered Names Under Management of the Applicable Registrar Family that is the fifth largest Applicable Registrar Family (measured by number of Registered Names Under Management), both for purposes of the numerator and the denominator; or</del></p> <p><del>6.10.2.2</del> The affirmative approval of 50% plus one of the Applicable Registrars that participate in the process to approve or disapprove (i.e. vote for or against, but not abstain or otherwise fail to vote) a proposed amendment under <del>this</del> Section 6, <del>and</del> the affirmative approval of Applicable Registrars accounting for 66.67% of the Total Registered Names Under Management by all Applicable Registrars; provided that, for purposes of calculating the Total Registered Names Under Management by Applicable Registrars, the Total Registered Names Under Management by each Applicable Registrar Family shall not exceed the total Registered Names Under Management of the Applicable Registrar Family that is the fifth largest Applicable Registrar Family (measured by number of Registered Names Under Management), both for purposes of the numerator and the denominator. An example of these calculations is set forth in Appendix 1 attached hereto.</p> <p><del>6.10.3</del> “Restricted Amendment” means (i) an amendment of the Consensus Policies and Temporary Policies Specification or (ii) the term of this Agreement as specified in Section 5.1, as such term may be extended pursuant to</p>	

Section	Change to Text	Change and Rationale
	<p><del>Section 5.2.</del></p> <p><del>6.10.4 “Total Registered Names Under Management” means the total number of Registered Names sponsored by all Applicable Registrars as reflected in the latest monthly reports submitted to ICANN by Registrars.</del></p> <p><del>6.10.5 “Working Group” means representatives of the Applicable Registrars and other members of the community that the Registrar Stakeholder Group appoints, from time to time, to serve as a working group to consult on amendments to the Applicable Registrar Agreements (excluding bilateral amendments pursuant to Section 6.9.</del></p>	
6.10	<p><del>6.10.6</del><u>6.10</u> Notwithstanding anything in this Section <del>6.10.6</del> to the contrary, (a) if Registrar provides evidence to ICANN’s reasonable satisfaction that the Approved Amendment would materially increase the cost of providing Registrar Services, then ICANN will allow up to one-hundred eighty (180) calendar days for the Approved Amendment to become effective with respect to Registrar, and (b) no Approved Amendment adopted pursuant to Section <del>6.10.6</del> shall become effective with respect to Registrar if Registrar provides ICANN with an irrevocable notice of termination pursuant to Section 5.4.</p>	Edit reflects the updating of the applicable cross reference.
7.4.5.2	<p>7.4.5.2 No dispute regarding the Proposed Revisions may be submitted for arbitration to the extent the subject matter of the Proposed Revisions (i) relates to Consensus Policy, (ii) falls within the subject matter categories set forth in Section 1.2 of <u>the Consensus Policies and Temporary Policies Specification</u> <del>±</del>, or (iii) seeks to amend any of the following provisions or Specifications of this Agreement: Sections 2, 4 and 6; subsections 3.1, 3.2, 3.3, 3.4, 3.5, 3.7, 3.8, 3.9, 3.14, 3.19, 3.21, 5.1, 5.2 or 5.3; and the Consensus Policies and Temporary Policies Specification, <del>±Data Retention Specification±</del>,</p>	Edit references appropriate specification, in response to public comment calling for clear identification of specifications.

Section	Change to Text	Change and Rationale
	WHOIS Accuracy Program Specification, Registration Data Directory Service (WHOIS) Specification or the Additional Registrar Operation Specification.	
Consensus Policies and Temporary Policies Specification, § 1.4	<p>1.4. In addition to the other limitations on Consensus Policies, they shall not:</p> <p>1.4.1. prescribe or limit the price of Registrar Services;</p> <p>1.4.2. modify the limitations on Temporary Policies (defined below) or Consensus Policies;</p> <p>1.4.3. modify the provisions in the Registrar Accreditation Agreement regarding terms or conditions for the renewal <del>or</del> termination <u>or amendment</u> of the Registrar Accreditation Agreement or fees paid by Registrar to ICANN; or</p> <p>1.4.4. modify ICANN's obligations to not apply standards, policies, procedures or practices arbitrarily, unjustifiably, or inequitably and to not single out Registrar for disparate treatment unless justified by substantial and reasonable cause, and exercise its responsibilities in an open and transparent manner.</p>	In response to public comment, edit clarifies that the amendment provisions of the RAA may not be modified through Consensus Policies.
Whois Accuracy Program Specification, § 1(e)	<p>e. Validate that all postal address fields are consistent across fields (for example: street exists in city, city exists in state/province, city matches postal code) where such information is <del>made</del> <u>technically and commercially</u> available <del>to Registrars</del> <u>for the applicable country or territory</u>.</p>	Revised text clarifies cross-field validation requirement in response to comment and to reflect current state of work.
Whois Accuracy Program Specification, § 1(f)	<p>f. Verify:</p> <p>i. the email address of the Registered Name Holder (and, if different, the <del>account holder paying for the Registered Name</del> <u>Account Holder</u>) by sending an email requiring an affirmative response through a tool-</p>	Edits reflect the creation of a new defined term in response to public comment.



Section	Change to Text	Change and Rationale
	<p>based authentication method such as providing a unique code that must be returned in a manner designated by the Registrar, or</p> <p>ii. the telephone number of the Registered Name Holder (and, if different, the <del>account holder paying for the Registered Name</del><u>Account Holder</u>) by either (A) calling or sending an SMS to the Registered Name Holder's telephone number providing a unique code that must be returned in a manner designated by the Registrar, or (B) calling the Registered Name Holder's telephone number and requiring the Registered Name Holder to provide a unique code that was sent to the Registered Name Holder via web, email or postal mail.</p> <p>In either case, if Registrar does not receive an affirmative response from the Registered Name Holder, Registrar shall either verify the applicable contact information manually or suspend the registration, until such time as Registrar has verified the applicable contact information. If Registrar does not receive an affirmative response from the <del>account holder paying for the Registered Name (when that information is different from the Registered Name</del><u>Account Holder</u>), Registrar shall verify the applicable contact information manually, but is not required to suspend any registration.</p>	
Whois Accuracy Program Specification, § 2	2. Except as provided in Section 3 below, within fifteen (15) calendar days after receiving any changes to contact information in Whois or the corresponding customer account contact information related to any Registered Name sponsored by Registrar (whether or not	Edit reflects the creation of a new defined term in response to public comment.

Section	Change to Text	Change and Rationale
	<p>Registrar was previously required to perform the validation and verification requirements set forth in this Specification in respect of such Registered Name), Registrar will validate and, to the extent required by Section 1, verify the changed fields in the manner specified in Section 1 above. If Registrar does not receive an affirmative response from the Registered Name Holder providing the required verification, Registrar shall either verify the applicable contact information manually or suspend the registration, until such time as Registrar has verified the applicable contact information. If Registrar does not receive an affirmative response from the <del>account holder paying for the Registered Name</del> <u>Account Holder</u>, Registrar shall verify the applicable contact information manually, but is not required to suspend any registration.</p>	
<p>Specification on Privacy and Proxy Registrations, § 2</p>	<p>2. <u>Obligations of Registrar.</u> For any Proxy Service or Privacy Service offered <del>through</del> <u>by</u> the Registrar or its Affiliates <u>(including through a Reseller)</u>, and used in connection with Registered Names Sponsored by the Registrar, the Registrar <u>and its Affiliates and Resellers</u> must require all P/P Providers to follow the requirements described in this Specification <u>and to abide by the terms and procedures published pursuant to this Specification.</u></p>	<p>In response to public comment, edits clarify that (i) obligations extend to Proxy Services or Privacy Services offered by Resellers on Registrar’s behalf, (ii) the referenced obligation extends to Registrar’s Affiliates and Resellers, and (iii) the P/P Providers must abide by the terms and procedures published pursuant to the specification.</p>
<p>Transition Addendum, § 6</p>	<p>6. ICANN and <del>the Working Group (as defined in the Agreement)</del> <u>an advisory panel of registrars</u> will work together to identify and specify an appropriate set of tools to enable Registrar to complete the across field validation specified in Section 1(e) of the Whois Accuracy Program Specification to the Agreement (the “Across Field Validation”). When <del>such tools are mutually agreed between</del> ICANN and the <del>Working Group</del> <u>advisory panel determine that such tools are technically and commercially available</u>, ICANN shall provide Registrar written notice of such <del>agreement</del> <u>determination</u> (which notice shall specify and describe the <del>agreed upon</del> <u>identified</u> tools). Effective on the one hundred eightieth (180<sup>th</sup>) calendar day following delivery of such notice by ICANN, Registrar shall comply with the obligations specified in Section 1(e) of the Whois</p>	<p>Edits reflect progression of discussions regarding the implementation of the Whois Accuracy Program.</p>

Section	Change to Text	Change and Rationale
	Accuracy Program. Until such time, ICANN will not enforce compliance with such requirements.	
Registrant's Contractual Rights and Responsibilities, Title	<b><i>Registrants' <u>Contractual Rights and Responsibilities</u></i></b>	Edit reflects new title in response to public comment.
Logo License Specification, Title	LOGO LICENSE <del>APPENDIX</del> <u>SPECIFICATION</u>	Edit reflects insertion of the existing logo license as a specification to the RAA.

# 2013-06-27-02c-Ref Mat-Attachment D-2013 RAA.pdf

## How the Proposed 2013 RAA Addresses Law Enforcement Recommendations

	<b>Summary of LE Recommendation</b>	<b>RAA Reference</b>
<b>1</b>	Registrar duty to investigate reports of illegal conduct, including responding to reports from law enforcement, and providing a system to track complaints	<ul style="list-style-type: none"> <li>• Section 3.18, requiring Registrars to maintain an abuse point of contact and provide a trackable system</li> </ul>
<b>2</b>	Registrar shall not engage in activities or conduct that results in: (i) a conviction by a court of competent jurisdiction of a felony or other serious offense related to financial activities; (ii) a judgment by a court of competent jurisdiction that Registrar has committed fraud or breach of fiduciary duty; (iii) the Registrar being the subject of a judicial determination that is the substantive equivalent of those offenses (i)-(ii); or (iv) the Registrar knowingly and/or through gross negligence, permitting criminal activity in the registration of domain names or in the provision of domain name WHOIS information, after failing to promptly cure such activity after notice thereof.	<ul style="list-style-type: none"> <li>• Section 5.5, which includes heightened and additional termination remedies</li> </ul>
<b>3</b>	Registrar collection of data regarding registrations in addition to the data already collected.	<ul style="list-style-type: none"> <li>• The Data Retention Specification includes new items of data for retention and maintenance</li> </ul>
<b>4</b>	Registrars abuse contact – posting of contact information and having a contact available around the clock	<ul style="list-style-type: none"> <li>• Section 3.18, requiring Registrars to maintain an abuse point of contact</li> </ul>

## How the Proposed 2013 RAA Addresses Law Enforcement Recommendations

	<b>Summary of LE Recommendation</b>	<b>RAA Reference</b>
<b>5</b>	Publication of registrar information, including contact details, as well as regular updates to ICANN regarding changes in registrar business information	<ul style="list-style-type: none"> <li>Section 3.17.1 will now require registrars to provide updates to ICANN of the type of information that is required upon application for accreditation</li> </ul>
<b>6</b>	Disclosure of affiliated registrars and affiliated businesses	<ul style="list-style-type: none"> <li>Section 3.17.1 (see item 5) incorporates this disclosure</li> </ul>
<b>7</b>	Privacy and Proxy Services – Escrow, Reveal and Relay	<ul style="list-style-type: none"> <li>Section 3.14, regarding the development of an ICANN accreditation program</li> <li>Proxy/Privacy Specification, putting in place interim requirements for proxy/privacy services offered through registrars</li> </ul>
<b>8</b>	ICANN Accreditation of Proxy and Privacy Services	<ul style="list-style-type: none"> <li>See item 7.</li> </ul>
<b>9</b>	Accountability of Resellers – Resellers must be held completed accountable to all provisions of the RAA.	<ul style="list-style-type: none"> <li>Section 3.12, imposing heightened obligations in relation to resellers</li> </ul>
<b>10</b>	Registrar validation of registrant data	<ul style="list-style-type: none"> <li>Whois Accuracy Specification, setting out requirements for validation and verification of registrant and account-holder data</li> </ul>
<b>11</b>	Whois service level agreements, with uptime minimums and specifying data update requirements.	<ul style="list-style-type: none"> <li>Whois SLA now includes these requirements</li> </ul>
<b>12</b>	Expansion of grounds of termination of RAA for criminal convictions, including “knowingly and/or through gross negligence permit criminal activity in the registration of domain names or provision of	<ul style="list-style-type: none"> <li>Section 5.5, which includes heightened and additional termination remedies</li> </ul>

# How the Proposed 2013 RAA Addresses Law Enforcement Recommendations

	<b>Summary of LE Recommendation</b>	<b>RAA Reference</b>
	domain name WHOIS information..."	

# 2013-06-27-02c-Ref Mat-Attachment E-2013 RAA.pdf



## Report of Public Comments

<b>Title:</b>	<b>Proposed Final 2013 RAA</b>		
<b>Publication Date:</b>			
<b>Prepared By:</b>	Samantha Eisner, Senior Counsel		
<b>Comment Period:</b>		<b>Important Information Links</b>	
Comment Open Date:	22 April 2013	Announcement	
Comment Close Date:	13 May 2013	Public Comment Box	
Reply Close Date:	14 May 2013	View Comments Submitted	
Time (UTC):	4 June 2013	Report of Public Comments	
<b>Staff Contact:</b>	Samantha Eisner	<b>Email:</b>	Samantha.Eisner@icann.org
<b>Section I: General Overview and Next Steps</b>			
<p>On 22 April 2013, after over 18 months of negotiations, the Proposed Final 2013 Registrar Accreditation Agreement (RAA) was posted for public comment. This was the third version of an agreement posted for the ICANN community, reflecting ICANN and the Registrar NT's agreements as the Proposed Final 2013 RAA.</p> <p>The Proposed Final 2013 RAA now includes provisions addressed to improve the image of the domain industry and to protect registrants through a further updated contractual framework. ICANN and the Registrar NT worked closely to consider all issues within the negotiations and the RAA reflects hard-fought concessions on many of key issues raised throughout the negotiations. The public comments received recognize that the 2013 RAA, if adopted, represents a significant improvement over the current 2009 version, and significantly raises performance requirements for every ICANN accredited registrar, thereby bringing dramatic improvements to the domain name ecosystem.</p> <p>The highlights of this proposed 2013 RAA include:</p> <ul style="list-style-type: none"> <li>• <b>The 12 Law Enforcement Recommendations</b> that served as the impetus for these negotiations are all addressed in this proposed draft. The attached Law Enforcement Summary Chart identifies the section or specification of the 2013 RAA that addressed each recommendation. Some of the highlights include the creation of an abuse point of contact at each registrar, Whois verification and validation requirements at the registrant and the account holder levels, stronger language on registrar obligations for resellers, and new data retention obligations.</li> <li>• <b>Enhanced Compliance Tools</b> including broader suspension and termination tools, clarification of audit rights and access to information to facilitate ongoing investigations, and annual certification requirements.</li> <li>• <b>A Registrant Rights and Responsibilities Document</b> that sets out, in clear and simple language, the rights and responsibilities that are set out in the 2013 RAA, such as the types of information that registrants can expect to be made available to them about terms and conditions of registrations, fees and customer service processes. The document also emphasizes the registrant's role in providing accurate contact information, and responsibilities in maintaining domain name registrations. These</li> </ul>			

enumerated rights and responsibilities are not comprehensive of all registrant rights and responsibilities set out in consensus policies, however this document is closely tied to the terms of the 2013 RAA.

- **Registrar Responsibility for Reseller Compliance** with all appropriate terms of the RAA.
- **Consolidation with the Registry Agreement for New gTLDs.** Where appropriate, ICANN and the Registrar NT have agreed to mirror language from the Registry Agreement, to allow for contracts that are better aligned. The New gTLD Registry Agreement and the 2013 RAA are anticipated to complement each other as Registries and Registrars move towards agreements that better reflect the changing marketplace.
- **Proxy and Privacy Provider Interim Requirements.** ICANN and the Registrar NT have agreed to interim protections that will be in place for proxy and privacy services offered through registrars. These interim protections will require that information is made available on items such as customer service processes and when a provider will relay information on the underlying user of the domain name registration. While these are not comprehensive of the protections that some have requested to be put in place for proxy and privacy providers, these interim protections will provide a more responsible marketplace until a formal accreditation program is developed.

When the agreement is updated to reflect the comments received that ICANN is able to take on, the agreement will be presented to the ICANN Board for approval. After that time, registrars will be able to sign onto the new agreement. ICANN is committed to participating in registrar educational opportunities to make sure that registrars are aware of their new obligations.

## Section II: Contributors

*At the time this report was prepared, a total of [number] (n) community submissions had been posted to the Forum. The contributors, both individuals and organizations/groups, are listed below in chronological order by posting date with initials noted. To the extent that quotations are used in the foregoing narrative (Section III), such citations will reference the contributor's initials.*

### Organizations and Groups:

Name	Submitted by	Initials
United-domains AG	Tobias Sattler	U-DAG
Intellectual Property Constituency	Steve Metalitz	IPC
Association of National Advertisers	Dan Jaffe	ANA
Registrar Stakeholder Group	Matt Serlin	RrSG
International Trademark Association	Claudio DiGangi	INTA
Music Community Coalition	Victoria Sheckler	MCC
GoDaddy	James Bladel	GD
Comcast/NBC Universal <sup>1</sup>	Meredith Baker	NBC
Non-Commercial Stakeholders Group	Robin Gross	NCSG
Business Constituency	Steve DelBianco	BC

<sup>1</sup> Comcast/NBC Universal submitted the same comment twice. It is reflected here once.

International AntiCounterfeiting Coalition	Andy Coombs	IACC
RU-Center	Tamara Khramtsova	RU-C
General Electric	Sean Merrill	GE
Internet Commerce Association	Philip Corwin	ICA
At-Large Advisory Committee	Staff supporting the At-Large	ALAC

**Individuals:**

Name	Affiliation (if provided)	Initials
MaverickII		MII
Jeremy Muras		JM
Garth Bruen		GB
Kathy Kleiman		KK

**Section III: Summary of Comments**

*General Disclaimer: This section is intended to broadly and comprehensively summarize the comments submitted to this Forum, but not to address every specific position stated by each contributor. Staff recommends that readers interested in specific aspects of any of the summarized comments, or the full context of others, refer directly to the specific contributions at the link referenced above (View Comments Submitted).*

MII proposed modifications to Section 2.3 of the RAA regarding ICANN responsibilities, suggesting inclusion of items relating to ICANN’s accountability mechanisms and “appeal processes”, as well as compliance reporting requirements. <http://forum.icann.org/lists/comments-proposed-raa-22apr13/msg00000.html>

U-DAG notes that the proposed RAA is an “improvement to the current 2009 RAA” and thanked the Registrars’ Negotiating Team. U-DAG also recommended clarification of items, including a definition of “thin” registry, a clear reference to the Whois Specification to avoid confusion, a definition of “commercially reasonable efforts” in regards to overseeing compliance of resellers, and definitions of “applicable law” and “appropriately” in terms of the abuse point of contact. U-DAG also expressed concern over the posting of an email address for the abuse point of contact, as well as the availability of cross-field validation technology for all registrars, and raised a question regarding how the address information would be “made available” to registrars. <http://forum.icann.org/lists/comments-proposed-raa-22apr13/msg00001.html>

The IPC focused its comments on the Proxy-Privacy Specification and the new amendment procedures. The IPC noted that revisions to the Specification did not take into account many of the IPC’s prior comments on this issue, as well as remove requirements for proxy service providers to abide by policies as disclosed. Of particular concern to the IPC is that there is no requirement for a proxy service to verify or validate customer information, nor consequences if information provided is insufficient to contact the provider. Further, the IPC requests that communications using “revealed” data that cannot reach the customer should then be subject to validation. The IPC also complains of the lack of full integration of the term “reseller” throughout the specification results in an exclusion of meaningful obligations for resellers. In addition, the Specification now requires disclosure of policies

and procedures, and does not set out what the procedures by which the services must abide, which removes obligations. The IPC asks for verification of customer data, at least when that data is revealed within the Whois record; clarification of application of the specification to resellers; and enforcement when proxy services fail to follow the policies that they set out. On the amendment process, the IPC questions ICANN's ultimate ability to bring forward an amendment in the public interest given all of the procedural steps introduced. Specifically, the IPC asks for assurances on the availability of this mechanism to bring forward the recommendations of the Expert Working Group on gTLD Registration Data, as one of the leading examples of usage of the amendment terms.

<http://forum.icann.org/lists/comments-proposed-raa-22apr13/msg00002.html>

The IPC also submitted reply comments noting that other commenters, such as the BC and INTA, mirrored the IPC's concern on the scope of the privacy/proxy specification. The IPC noted that other commenters also shared the IPC concerns over the amendment processes. The IPC also commented on the RrSG and GD comments, regarding registrar concerns over cross-field validation and noted that these concerns are "overblown". The IPC urged that if registrars are slow to implement the new requirements, ICANN should not tolerate this behavior. <http://forum.icann.org/lists/comments-proposed-raa-22apr13/pdfdIMfEsmWrq.pdf>

The ANA stressed that the RAA should be finalized and in effect before any new gTLD contracts are approved. The ANA expressed concern regarding the capacity of ICANN's Contractual Compliance Department to meet the increased compliance demands, and that the automated systems that are in planning should be in place before delegation of new TLDs. The ANA expressed its encouragement that ICANN adopted the law enforcement recommendations in improving the RAA, but noted that the Whois Accuracy Program requirements for verification of email OR phone number and the Proxy Specification "may not satisfy law enforcement requirements." The ANA supports the inclusion of terms to proven cybersquatting, as well as extension of obligations to resellers. In the amendment process, while the ANA would have liked to have seen more direct amendment by the ICANN Board, the processes that are defined in the proposed agreement are an enhancement over the lack of enforceability that exists today. <http://forum.icann.org/lists/comments-proposed-raa-22apr13/msg00011.html>

The RrSG noted that while registrar representatives participated in the negotiation of the RAA, due to the diversity of the RrSG, individual members were encouraged to submit individual comments as well. On the amendment process, the RrSG noted that the amendment language is an improvement over the initial proposal from ICANN, though concerns still remain. The RrSG requested some examples to help demonstrate the scope of the process. In addition, the RrSG requested that the Board-approved amendment process not be used in ways that affect the scope of the agreement, as well as a 24-month review cycle to confirm the Board-approved amendment process is of continuing viability and need. In addition, the RrSG noted its concerns relating to the cross-field validation portion of the Whois Accuracy Program, stating that though the registrars will participate in the working group as specified in the transition addendum, the RrSG believes that the use of cross-filed validation requires community dialogue as it is a "dramatic change to the registration of domain names." The RrSG stresses that the matter of import of now is to start working on an educational plan to assure that registrars understand the new obligations.

<http://forum.icann.org/lists/comments-proposed-raa-22apr13/msg00003.html>

INTA applauds the substantial progress made in the negotiations, while highlighting remaining issues of concern. INTA suggests that the RAA is an appropriate mechanism to address parts 2 and 6 of the Governmental Advisory Committee's safeguard advice for the New gTLD Program, such as incorporation of requirement for prohibitions of malicious activity. On the Whois Accuracy Program, INTA is supportive of the account holder verification requirement that has been incorporated, but encourages the adoption of more stringent verification requirements, such as the verification of email and phone numbers. On the Proxy/Privacy Service Specification, INTA is encouraged by ICANN's use of the negotiations to bring this issue into the negotiations, as well as the compromise of having an interim specification while the community conversation goes forward. However, the draft specification removes many of the advancements seen in the 7 March 2013 version, as it now states "unenforceable guidelines," and should expressly require verification obligations that are stated in the Whois Accuracy Program so as not to circumvent the verification requirements. On Whois data elements, INTA recommends that the elements set out at 3.2.1 should be minimum required elements that are not subject to change by agreement, though they can be added to. INTA does not support the removal of Port 43 obligations for "thick" registries. For the special amendment process, INTA opposes the system as set out in Section 6 of the agreement, arguing for a more streamlined process, and suggesting that ICANN and the Registrars return to negotiations on this point. INTA states that the process has to be workable and result in amendments; the revisions to Section 6 "swings the pendulum too far" in allowing endless debate and appeals. On the negotiation process, INTA notes its dissatisfaction with ICANN's use of bilateral negotiations for the RAA negotiation process, given ICANN's role in the DNS. The exclusion of the public from the participation in the discussions does not further the Internet public's confidence in ICANN. INTA also notes that the short window for comment, released with a statement that the negotiations have drawn to a close, casts doubt on how public comments will be considered. INTA also calls upon ICANN to consider how the results of the Expert Working Group on gTLD Registration Data will be assimilated into the RAA.

<http://forum.icann.org/lists/comments-proposed-raa-22apr13/pdfKyVFpWBi8R.pdf>

The MCC, representing various regional, national and international trade associations, thanked the negotiators for the substantial progress on addressing false Whois data, compliance enforcement, and measures to deter illegal or abusive activity. The MCC noted its dismay at the Privacy and Proxy Registration specification, as it does not include requirements for verification or validation of customer data. While there are legitimate uses for privacy/proxy services, the proxy/privacy specification will give "greater incentive" for bad actors to use privacy/proxy services unless a validation requirement is in place. MCC suggests ICANN adopt verification requirements for proxy/privacy services, as well as ensuring compliance with these heightened requirements.

<http://forum.icann.org/lists/comments-proposed-raa-22apr13/pdfGXTwbheW5y.pdf>

GD thanked ICANN for its efforts in negotiation, and highlighted that the proposed RAA will "eliminate continuous negotiations, provide stability for registrars at renewal, and provide uniformity with new gTLDs" where appropriate. GD also raised some concerns. On Section 6.5, for the special amendment process, GD notes that there is no specified standard of review for determining when an amendment is "in the public interest." This could pose issues in the Working Group's ability to review the



proposed amendment, as well as in ICANN's ability to provide a detailed rationale for its decision to proceed with such an amendment. GD recommends further work on this part, and that the Accountability and Transparency Review Team consider this provision. On the Consensus Policy specification, GD suggests that the language be clarified to exclude the amendment and negotiation processes from those topics for which consensus policy is appropriate. On the Whois Accuracy Program, GD states its concern that cross-field validation "cannot be implemented fairly, consistently, or equitably" across registrars or registrants, and suggested that consideration be given to ICANN's Core Value number 8, on applying policies neutrally and objectively, as well as the Bylaws requirement for non-discriminatory treatment. GD stands ready to participate in further work on this issue. <http://forum.icann.org/lists/comments-proposed-raa-22apr13/pdfOQBzSnC1U.pdf>

NBC commented that though it has reservations regarding the bilateral negotiation process used to reach the 2013 RAA and how that fits into the multi-stakeholder model, the final outcome is largely positive. The proposed 2013 RAA is a significant improvement, and with quick adoption and appropriate enforcement resources, will make the DNS "safer, more predictable environment for legitimate users worldwide." However, the final language is "not as rigorous" as what NBC would have proposed in the areas of authentication, and data accuracy. On proxy registrations, NBC questions the "ced[ing of] authority to an as-yet-undeveloped future ICANN policy on the issue." This will create a hole for scammers. NBC remains supportive that the 2013 RAA is finalized before new gTLDs go into the root, and registrars be required to sign the new RAA before offering new gTLD domain names for sale. ICANN's commitment to enforcing the terms for the agreement will be essential to the success of the new agreement. <http://forum.icann.org/lists/comments-proposed-raa-22apr13/pdfezxaFQgSh0.pdf>

The NCSG recommended new language for inclusion in the Registrant Rights and Responsibilities document, as "the existing Registrant Rights and Responsibilities draft lacks the substantive rights registrants expect and demand for assurance of the security and stability of the domain registrations." The NCSG's draft including rights and responsibilities derived "from applicable law as well as from the web of ICANN-based contracts." The draft incorporates items from the agreement, as well as those outside of the language of the agreement. <http://forum.icann.org/lists/comments-proposed-raa-22apr13/pdfsT1mQRi6IS.pdf>

JM suggests that for Section 3.7.7.2, the requirement for "willful" provision of inaccurate or unreliable information as a grounds for breach of the registration agreement is too subjective, and recommends that a more objective test be incorporated into this provision. <http://forum.icann.org/lists/comments-proposed-raa-22apr13/msg00013.html>

GB, writing on behalf of "our membership and community participants", raises the issue of the change to Section 3.3.6, the requirement for registrars to make available bulk access to Whois. GB states that staff has not yet responded to requests for information on the economic basis for the decision to remove this provision, and requests that this contract change be dropped for lack of transparency in process. <http://forum.icann.org/lists/comments-proposed-raa-22apr13/msg00014.html>

The BC notes that ICANN must ensure that its compliance function is staffed to enforce the new RAA. Because of the complexity of the document, the BC recommends the use of a table of contents and table of specifications, for ease of comprehension and navigation. The BC also makes some suggestions for incorporating all definitions in one place. The BC also makes specific suggestions, including (1) requiring a seven day window for updating registered name data; (2) revising Section 3.7.7.2 to require suspension or cancellation of names, as opposed to the discretionary language currently used; (3) incorporating a prohibition on engaging in false advertising or other deceptive practices, which is set out in the Registrants' Rights and Responsibilities; (4) requiring annual re-verification of information under the Whois Accuracy Program; (5) when amendments or exemptions from certain provisions of the RAA are sought, the BC is calling for multi-stakeholder representation and public input into those processes. The BC requests more information on the paths for revising the form RAA and whether registrars will be able to elect to stay on an old form of the agreement as opposed to a revised form. For the Proxy/Privacy Specification, the BC would like to see specific content requirements added, such as specification of the circumstances under which the proxy service provider will relay communications to the underlying customer as well as timing and confirmation requirements, as well as requirement for when the Whois information will be revealed and the timeframe for that. The BC recommends that P/P Providers be required to relay all communications to the underlying customer that allege illegal conduct or consumer fraud and to reveal the contact details of the underlying customer within seven business days if illegal activity is alleged. The BC also suggested that communications that must be relayed to the underlying customer be relayed within three business days. The BC also recommends the incorporation of a mechanism to amend the specification by the parties and stakeholders. On the Whois Accuracy Program, the BC urged that pre-resolution verification be required, as opposed to the 15-day window included in the specification, and requested that registrars be required to verify both an email address and a phone number, as opposed to either point of data. <http://forum.icann.org/lists/comments-proposed-raa-22apr13/pdfZIRaUTlz0.pdf>

The IACC endorses the IPC comments, and reiterated points raised by other commenters including: (1) negotiations should not have been closed, bilateral negotiations; (2) the public comment seems to be a formality given the "final" nature of the agreement; (3) earlier comments on Whois validation and privacy/proxy issue were not considered and the proxy specification was "diluted". <http://forum.icann.org/lists/comments-proposed-raa-22apr13/pdfkWdg1M2ZYW.pdf>

RU-C noted that it has to comply with the laws of the Russian Federation. This includes a requirement that customers are entitled to withdraw payments. The commenter also noted some concerns as it relates to resellers and the provision of information regarding the registrars that are actually sponsoring domain name. <http://forum.icann.org/lists/comments-proposed-raa-22apr13/msg00017.html>

GE supports the comments of the IPC, BC, NBC, MCC, ANA and INTA, as well as prior law enforcement statements, on the importance of increasing obligations on Whois data and registered name holder identifying information. GE states that proxy and privacy services should be allowed only in "rare circumstances (and all such circumstances should be limited to non-commercial activity)," suggesting that proxy or privacy registrations are against the Affirmation of Commitments. GE also pointed out

that there is no requirement for validation of the underlying information for proxy or privacy registrations, and it is “untenable” to have users of proxy/privacy services “get a free pass.” GE also requested pre-resolution verification requirements, and requested mandatory suspension of domain names for the willful provision of false or inaccurate Whois information. GE repeated INTA’s suggestion of making certain items of Whois data mandatory minimum requirements. GE also supported the mandatory use of the new RAA in the New gTLD Program.

<http://forum.icann.org/lists/comments-proposed-raa-22apr13/pdfIW9ksOdAtH.pdf>

The ICA agreed with the NCSG that the Registrant Rights and Responsibilities document needed to be strengthened, and proposed additional modifications to the NCSG’s proposed version. The ICA added terms including neutral arbitration of UDRP disputes, clear disclosure of terms, and additional responsibilities. <http://forum.icann.org/lists/comments-proposed-raa-22apr13/pdfkMaSuJG61H.pdf>

The ALAC provided many comments in support of the new RAA, including the Board-approved amendment process and that it is important to have this safeguard in place for exceptional circumstances. The ALAC also supported the clear statement of topics included within consensus policy. The ALAC noted its dissatisfaction with being excluded from the RAA negotiation process and the lack of transparency. On Whois, the ALAC agreed that all Whois information – including information of the underlying user of proxy/privacy services, should be verified. For the verification of account holder information, the ALAC is concerned that suspension is not required in this instance, and recommends providing a clarifying definition for the account holder. The ALAC also suggesting harmonizing the verification requirements to match the required fields for Whois information. On the Proxy/Privacy Specification, the ALAC supports this development, but requests that proxy and privacy services providers should accept strict liability for harm, and that third party beneficiary rights should be included in the specification. <http://forum.icann.org/lists/comments-proposed-raa-22apr13/pdftgcL1YrEzF.pdf>

KK expressed support for the NCSG position on the Registrant Rights and Responsibilities document, noting that it was drafted without input of the Registrant groups in ICANN. KK also expressed her opposition to the change in Section 3.7.7.2, replacing “promptly” with a seven-day requirement for update to registrant information after a change. KK notes that this will lead to unfair results, as domain cancellation may occur without any demonstration of harm, notice to the registrant, or while otherwise accurate information remains in the Whois record. This will encourage “spying” and reporting from those that want desirable domain names, and is not tied to the security or stability of the DNS. <http://forum.icann.org/lists/comments-proposed-raa-22apr13/msg00022.html>

#### **Section IV: Analysis of Comments**

*General Disclaimer: This section is intended to provide an analysis and evaluation of the comments received along with explanations regarding the basis for any recommendations provided within the analysis.*

Many of the commenters on the proposed Final 2013 RAA expressed their support for the new agreement, noting that the new contractual provisions are an improvement over the current



obligations stated within the 2009 RAA. Though commenters were generally in favor of the advancements within the new RAA, they identified specific areas where they wished for clarification or strengthening of terms within the agreement. In addition, multiple commenters noted that while they are generally supportive of the outcomes of the negotiations, they are dissatisfied with the negotiation process that was used. The commenters objected to the use of bilateral negotiations among ICANN and the Registrar Negotiating Team, as opposed to a process where community members could observe and participate in the negotiations. As has been previously discussed, the RAA itself did not include any path to negotiation; the process to be used was not clear. To help assure that the community will have a voice in future amendments to the RAA, the RAA now incorporates specific public comment requirements when amendments are under consideration or negotiations have been initiated.

Multiple commenters requested that the new RAA be in place before the delegation of new gTLDs. The New gTLD Registry Agreement as posted includes a requirement that Registries only use Registrars under the 2013 RAA. In addition, the ICANN Board has accepted GAC advice on this same issue. ICANN is working towards timing the approvals of each of the 2013 RAA and the new gTLD Registry Agreement to make sure this happens.

Some of the most common areas suggested for modification include:

- Whois Accuracy Specification: Require pre-resolution verification; require verification of both an email address and a phone number; require annual re-verification of data; make suspension mandatory if account holder data
- Proxy/Privacy Specification: Require proxy service providers to validate underlying customer information; incorporate specific requirements for how relay of communications will occur and for reveal of underlying customer data, as opposed to the statements that service providers must post information on the processes they have available; make clearer that the requirements of the specification are applicable to resellers
- Three commenters suggested modifications to the Registrant Rights and Responsibilities
- Three commenters suggested that there be mandatory minimum requirements for Whois data elements, and that Registries could place additional items onto this list with ICANN approval, but could not take away any of the minimum elements

There are some areas where further changes at this time are not feasible. As ICANN previously noted in relation to calls for validation of proxy/privacy customer data and for enhancements to the Whois Accuracy Program Specification to allow for pre-resolution verification and for verification of multiple points of data, each of these items are anticipated to be the subject of future policy development work, which will provide a more appropriate venue to continue consideration of the balance of need, cost and public impact of the suggested changes. ICANN has already committed to, and is in the process of, re-initiating work towards a Privacy/Proxy Accreditation Program. In addition, the ICANN Board has already requested the initiation of a PDP to identify a replacement for the current Whois system, and the report and recommendations of the Expert Working Group (EWG) convened to look at this issue will be part of this PDP work. Given the forthcoming policy work in each of these areas, as well as the lack of consensus today within the community regarding the proper scope of

Privacy/Proxy services and the Whois system, it remains appropriate to hold off on further broad changes to either of these Specifications in favor of the community-based solutions that will arise out of the policy work. Similarly, incorporating minimum requirements for Whois data elements (which would modify a portion of the RAA that has long been in existence) is similarly premature given the anticipated policy work on the replacement of the Whois system.

While many commenters expressed concern that not including further detail in the Proxy/Privacy Specification, including a validation requirement, and setting out requirements for relaying of communication and reveal of underlying customer data, and imposing third-party beneficiary liability for failures to reveal, we have previously heard comments that using the RAA negotiations as the mechanism for introduction of all of these new requirements – all to be enforced through registrars – is not the proper place for this conversation to occur. This also leans in favor of the holding off on further changes to this Specification to allow the policy work to go forward. While some commenters noted concern with the temporary nature of the Proxy/Privacy Specification, it is ICANN's hope that the temporary nature will serve as a catalyst to get the community to participate swiftly and meaningfully in the forthcoming policy development work. The exclusion of the Specification from amendment processes was also a key negotiating point, so that patching of the stop-gap measure of the Specification was not seen as the tool for development of the future Proxy/Privacy Accreditation work.

One area where ICANN is taking a further look at the Proxy/Privacy Specification is in regards to the incorporation of resellers into the Specification. While resellers are specifically identified in the preamble to the Specification, commenters raised concerns that the actual text of the Specification did not impose any obligations as it relates to resellers. ICANN will be reviewing the language of the RAA in full, as well as the specification, to determine if any changes are necessary to make the contractual obligation clearer on this point.

ICANN is also reviewing some suggestions received for incorporation of new definitions into the RAA to assist in clarification, such as providing a definition for "account holder"; assuring that all definitions within the agreement are together in one place; providing a clearer identification of all specifications to the agreement; clarifying the Consensus and Temporary Policy Specification to specifically exclude the amendment and negotiation processes from being the subject of policy; and reviewing again the use of specific timeframes as opposed to the use of terms such as "promptly" to help define clear obligations on the part of the Registrar.

For the Registrant Rights and Responsibilities document, there were two versions of a new document posted by commenters as alternatives to the version posted for comment. The current Registrant Rights and Responsibilities document, as posted with the agreement, was not meant to be a full statement of all registrant rights and responsibilities arising out of being a domain name registrant. Rather, it is specifically targeted to identify contractual rights and responsibilities that are stated within the RAA, as opposed to looking to consensus policy or to broader principles of privacy rights. While the suggestions raised in the versions presented during the comment period incorporate some ideas that could be of great value for the community to discuss, they are not geared to the limited purpose of the document. To help clarify the purpose of the document, ICANN will be considering

clarifying the title of the document prior to finalizing the RAA.

One commenter queried the basis for removal of the Bulk Access requirements for Whois. ICANN will be publishing a summary of the economic basis that supports the removal of the Bulk Access provisions, to provide some transparency into that decision. Another commenter requested information on when the RAA would be revised and the options that exist for Registrars to stay on the old form of the RAA as opposed to a new form. One of the advantages of the new amendment process that is built into the 2013 RAA is that we anticipate that, once the 2001 and 2009 versions are phased out, we will no longer have multiple versions of an RAA, but rather a single version that is capable of amendment. If however, there is a need to adopt a new form of the RAA in the future, Registrars will be offered the opportunity to move to that new form. While this is an unlikely scenario given the flexibility of the 2013 RAA, it seemed prudent to be explicit about this remote possibility that will be of benefit in moving Registrars to new forms of agreement if they are ever adopted.

Some registrar commenters identified concerns relating to the use of cross-field validation. ICANN has already begun work with a volunteer registrar advisory group regarding the implementation of this new Whois accuracy requirement in a feasible manner. One registrar commenter requested clarification of the provision of the Whois Accuracy Specification that requires registrars to perform cross-field validation when requisite data is “made available” to registrars. Accordingly, ICANN is considering revisions to the specification to clarify that performance of cross-field address validation is required when the requisite data is technically and commercially available to registrars. In addition, ICANN will also be considering providing updates to the transition document to reflect the status of the work with the advisory group.

ICANN carefully reviewed all of the public comment submissions on the RAA. Through the series of opportunities for discussion on the RAA since the negotiations started in 2011, ICANN and the registrars have heard many items of concern as were raised in this comment forum, particularly as they relate to Whois and the Proxy/Privacy Specification. As a result, ICANN and the Registrars are not in a position to adopt some of the suggestions presented by multiple commenters on those issues, as they have been the subject of intense negotiation and reserved for policy discussion. However, some of the items raised within the comment forum, particularly those focusing on clarity and ease of understanding of the document, will be considered for updating. In addition, some of the items raised are already addressed within the RAA, such as requirements to update Whois data within seven days of changes, allowance for public input into the amendment or exemptions process, or the fact that resellers are able – at any time – to identify the sponsoring registrar of a domain name. While it is not feasible to incorporate every suggestion that was received on the RAA, the resulting RAA will have a lot of positive enhancements for the ICANN community. The changes, including Whois verification, minimum standards for proxy services, and others, represent major shifts in registrar obligations.

When the agreement is updated to reflect the comments received that ICANN is able to take on, the agreement will be presented to the ICANN Board for approval. After that time, registrars will be able to sign onto the new agreement. ICANN is committed to participating in registrar educational opportunities to make sure that registrars are aware of their new obligations.

# 2013-06-27-02c-Ref Mat-Attachment F-2013 RAA.pdf

## Report of Public Comments

<b>Title:</b>		<b>Proposed Draft 2013 RAA Posted For Public Comment</b>									
<b>Publication Date:</b>		7 March 2013									
<b>Prepared By:</b>		Margie Milam, Senior Director, Strategic Initiatives									
<b>Comment Period:</b>		<table border="1"> <tr> <th colspan="2" style="text-align: center; color: red;">Important Information Links</th> </tr> <tr> <td colspan="2" style="text-align: center;">Announcement</td> </tr> <tr> <td colspan="2" style="text-align: center;">Public Comment Box</td> </tr> <tr> <td colspan="2" style="text-align: center;">View Comments Submitted</td> </tr> </table>		Important Information Links		Announcement		Public Comment Box		View Comments Submitted	
Important Information Links											
Announcement											
Public Comment Box											
View Comments Submitted											
Open Date:	7 March 2013										
Close Date:	28 Mar13/Reply 19 Apr 13										
Time (UTC):	23:59										
<b>Staff Contact:</b>	Margie Milam	<b>Email:</b>	margie.milam@icann.org								
<b>Section I: General Overview and Next Steps</b>											
<p>ICANN sought public comments on a proposed 2013 Registrar Accreditation Agreement (RAA), particularly on areas where ICANN and the Registrar Negotiating Team had not been able to reach agreement in principle. This was the first time in the nearly 18 months of negotiations that community comment was formally sought on this document.</p> <p>ICANN and the Registrar Negotiating Team commenced negotiation on amendments to the RAA in October 2011. While the documents posted in this Public Comment Forum reflected many areas of agreement, there were differences between the ICANN and Registrar positions, as highlighted in the documents posted. Since the posting, ICANN and the Registrar Negotiation Team have engaged in extensive negotiation sessions prior to, during, and after ICANN’s Beijing Meeting regarding the open issues in the RAA and the specifications. While in Beijing, the negotiation teams announced an agreement in principle on the remaining items, several of which address issues raised in this Public Comment Forum.</p> <p>During the Beijing Meeting, ICANN announced that it would open a new public comment forum on the fully negotiated 2013 RAA. After review of the comments to be received in the additional public comment forum to be opened shortly, the proposed 2013 RAA will be reviewed to determine if further changes are warranted. The ultimate goal is to have a 2013 RAA completed and approved in the near future for use in the New gTLD Program.</p>											

## Section II: Contributors

*At the time this report was prepared, a total of twenty-two (22) community submissions had been posted to the Forum. The contributors, both individuals and organizations/groups, are listed below in chronological order by posting date with initials noted. To the extent that quotations are used in the foregoing narrative (Section III), such citations will reference the contributor's initials.*

### Organizations and Groups:

<b>Name</b>	<b>Submitted by</b>	<b>Initials</b>
At-Large Advisory Committee	Alan Greenberg	ALAC
Registrar Stakeholder Group	Michele Neylon	RrSG
Non-Commercial Stakeholder Group	Robin Gross	NCSG
ISP Constituency	Wolf Knobon	ISP
Intellectual Property Constituency	Steven Metalitz	IPC
International Anti-Counterfeiting Coalition	Andy Coombs	IACC
Demy's Ltd.	Gordon Dick	DM
1&1 Internet AG	Thomas Keller	1&1
Cronon AG	Michael Shohat	CR
Eco Association	Thomas Richert	ECO
LegalScript	John Horton	LS
Web.com	Bob Weigand	Web
Coalition for Online Accountability	Steven Metalitz and endorsed by the COA	COA
NBC Universal	Meredith Baker	NBC

### Individuals:

<b>Name</b>	<b>Affiliation (if provided)</b>	<b>Initials</b>
Benjamin Kerensa		BK
Bill Silverstein		BS
Wendy Seltzer	Wendy Seltzer, Joy Liddicoat, Robin Gross, and endorsed by the NCSG	WS
Mark Andrews		MA
Moritz Bartl		MB
Dave Wrixon		WG

### Section III: Summary of Comments

*General Disclaimer: This section is intended to broadly and comprehensively summarize the comments submitted to this Forum, but not to address every specific position stated by each contributor. Staff recommends that readers interested in specific aspects of any of the summarized comments, or the full context of others, refer directly to the specific contributions at the link referenced above (View Comments Submitted).*

#### General Observations Regarding the Draft 2013 RAA

During the public comment forum, a total of twenty-two (22) comments were submitted during the open public comment period. With regard to submissions from SO/ACs, or their constituencies, the GAC, ALAC, Intellectual Property Constituency and ISP Constituencies voiced general support for the revised RAA, while the RrSg and NCSG voiced opposition to the process as well as specific amendment proposals.

However, the RrSg's position may be tempered by the developments since the initial posting of the RAA. Specifically, negotiations have continued through the pendency of the public comment forum, leading to an announcement at the ICANN Beijing Meeting that the Registrars' Negotiation Team and ICANN have agreed in principle to a new form of the 2013 RAA to be posted for public comment shortly. Similarly, in its Beijing Communiqué, the GAC advised ICANN to finalize the 2013 before any new gTLD contracts are approved and strongly supported the amendment to the new gTLD registry Agreement that would require new gTLD registry operators to use only those registrars that have signed the 2013 RAA.

#### Comments in Support or Opposition of the Draft 2013 RAA

The ALAC is generally in agreement with ICANN on the issues where ICANN and Registrars disagree.

The proposed RAA is much better than its predecessor. It provides clarity where previously obscurity and even obfuscation ruled, and many of the omissions of earlier RAAs have been addressed. All parties in the current round of negotiations are to be congratulated. *Comments of the ALAC submitted by Alan Greenberg.*

Amid objections related to the remaining points of differences, the RrSg states that... “[A]ll of the items that have been agreed to over the past 18 months would, by themselves, produce an RAA that is vastly improved over the current 2009 version. If adopted, that RAA would significantly raise performance requirements for every ICANN accredited registrar and bring dramatic improvements to the domain name ecosystem.” *Comments of the RrSg submitted by Michele Neylon.*

The IPC believes “the revised Section 3 includes some significant changes representing positive steps toward addressing issues that have long plagued IP rights holders – such as better access to more accurate WHOIS data and enforcement of rules compliance against rogue registrars, resellers, and privacy and proxy services – but we believe some of these provisions still require revision to be fully

effective.” *Comments of the IPC, submitted by Steve Metalitz and endorsed by the COA.*

Comcast/NBCUniversal’s initial review of the “progress on the 2013 RAA reaffirms our belief that the proposed contract represents an important evolutionary step forward from the 2009 contract. The current iteration of the 2013 RAA still represents a major step forward for the safety, stability and reliability of the DNS.” *Comments of NBC Universal, submitted by Meredith Baxter.*

IACC sees the Draft 2013 RAA as a “constructive step in the right direction and, in many ways, an elegant compromise between ICANN’s responsibilities and ICANN’s ongoing policy development processes concerning some of these same issues.” *Comments of the IACC, submitted by Andy Coombs.*

LS applauds “the move toward greater transparency and accountability by better identifying resellers and holding them accountable to the RAA and other ICANN requirements; preventing the use of “rogue” proxy WHOIS services, which LS has observed being utilized by rogue Internet pharmacy networks; and steps intended to improve WHOIS accuracy.” *Comments of LS, submitted by John Horton.*

In negotiating the contracts that form the basis of its governance regime, ICANN is performing a public, not private, function. In doing so, it has duties to the public, registrants included, to keep our interests in mind... it does not reflect good public policy. *Comments of Wendy Seltzer, Joy Liddicoat, Robin Gross, submitted by WS, and endorsed by the NCSG.*

#### **Process Concerns**

The RrSG believes that some of the other new items for inclusion transcend the RAA and could affect the entirety of the multi-stakeholder model. For example, ICANN insisted on including a proposed Revocation Clause that would have given them the ability to unilaterally terminate all registrar accreditations. After major pushback, ICANN staff relented and in its place proposed giving the ICANN Board the ability to unilaterally amend the RAA. This is identical to what ICANN inserted into the proposed new gTLD registry agreement—a clause met with strong opposition not only from the Registry Stakeholder Group but from the broader ICANN community. *Comments of the RrSg submitted by Michele Neylon.*

On a process level, the ALAC wishes to commend ICANN staff for presenting this information in such a way and with multiple views so as to make this very complex set of documents and the differing viewpoints comprehensible. That being said, there are a number of issues where (i) The ALAC is uncomfortable with the position that ICANN has taken; and (ii) The ALAC believes that additional changes are necessary. *Comments of the ALAC submitted by Alan Greenberg.*

The RAA is one of the central contractual underpinnings of the entire ICANN framework for management of the Domain Name System, and thus of the multi-stakeholder model that ICANN purports to embody. Allowing a mere 21 days for public comment on the numerous and complex documents released on March 7 is grossly insufficient, and inconsistent with ICANN’s oft-stated (but not always honored) commitment to accountability and transparency. *Comments of the IPC,*



*submitted by Steve Metalitz and endorsed by the COA.*

In negotiating the contracts that form the basis of its governance regime, ICANN is performing a public, not private, function. In doing so, it has duties to the public, registrants included, to keep our interests in mind. As lawyers, technologists, and members of the Non-Commercial Users Constituency, we do not believe the latest proposed Registrar Accreditation Agreement (RAA) does so. As such, it does not reflect good public policy. *Comments of Wendy Seltzer, Joy Liddicoat, Robin Gross, submitted by WS and endorsed by the NCSG.*

COA urges that the entire proposed revised RAA be compared against the list of high and medium priority items identified for change in the RAA by the GNSO-ALAC joint drafting team in October 2010, and that that comparison be made public. *Comments of COA submitted by Steve Metalitz.*

CR states that “ [I]ike many of our registrar colleagues we've been closely following the RAA negotiations and were very disappointed by the way ICANN staff handled the final part. We are thus writing in strong support of the registrar negotiating team and its statement from March 8th.” *Comments of Cronon, submitted by Michael Shohat, also supported by 1&1.*

DM thanks the registrar negotiating team for their hard work on this topic and note significant concerns that ICANN's determination to meet a self-imposed deadline to force the use of the new RAA may undermine the credibility of the continuance of the current multi-stakeholder model. It is imperative that ICANN get the RAA 2013 correct not simply have it in place for their self-imposed deadline. *Comments of DM submitted by Gordon Dick.*

DM is also every concerned with the short comment period and the appearance of additional documents justifying ICANN's position in an ad-hoc fashion after publication in a manner that means it is not clear it has been published. This is not in line with good governance standards expected from either Governments or governing organizations. *Comments of DM submitted by Gordon Dick.*

Having followed the process reasonably carefully from a distance, it is clear that process was swamped with Lobbying of English speaking public interest groups and that most of the issues relating to IDN and Asia simply got drowned out. *Comments of DW submitted by Gordon Dick.*

### **New Topics to Be Included**

Several commentators suggested additional topics to be addressed in the 2013 RAA. These include, requiring registrars to delete expired domain names, rather than do what they do now - either taking over ownership of expired domains, or auctioning them off for their own financial benefit. *Comments of ceo@xxxxxx.com.*

The RAA should address IDN Transliteration of existing gTLDs. According to DW, “[t]he potential user confusion is obvious. However, the issue extends far beyond the rights of registrants which have been largely ignored, but extend to the potential of enormous systemic phishing due to the creation of audibly identical gTLDs in a number of scripts which represent all the biggest registries.” *Comments of DW.*

The maintenance of NS, DS, A and AAAA should be treated equally as core parts of maintaining a delegation. There is currently no requirement, proposed or otherwise, for registrars to treat the creation and maintenance of these records on an equal footing. Such a requirement should be clearly stated. *Comments of MA.*

### **Registrant Rights and Responsibilities (R3)**

Although registrars were surprised by these new demands, registrars worked in good faith with ICANN to accommodate its intentions. For example, registrars consulted with their members to fine-tune the R3 document to make it easier to understand and readily translatable in other languages. *Comments of the RrSg submitted by Michele Neylon.*

The "Registrants' Rights and Responsibilities" document gives "feeble rights in exchange for onerous (or unenforceable) responsibilities. It should not have been tabled without input from community and especially across community constituencies. Registrants rights are a foundational aspect of the RFCs which guide the DNS. To purport to define these without community input is not only misguided, but also contrary to the very rights the proposal seeks to assert." *Comments of Wendy Seltzer, Joy Liddicoat, Robin Gross, submitted by WS and endorsed by the NCSG.*

### **Data Retention Requirements**

The following commentators generally objected to the data retention obligations: ECO, and Cronon AG, web.com, while the following commentators believed that the amendments did not go far enough: IPC, IACC, Benjamin Kerensa, COA, and Bill Silverstein.

Regarding Data Retention Specification 1.1.8 – Card-on-File, "the impact of this change is unclear. If it is referring to credit card information where a registrar or client chooses to not have the registrar save the card number for future use, the issue is a difficult one. The ALAC understands the benefit of maintaining such information for forensic purposes, but at the same time believes strongly that a consumer should be able to require that such information not be stored and therefore subject to hacking and theft. *Comments of the ALAC submitted by Alan Greenberg.*

Regarding Data Retention Specification 2 – Trigger for exemptions, the ALAC supports the Registrar position of allowing a contracted party to comply with local law before they are under investigation or cited. *Comments of the ALAC submitted by Alan Greenberg.*

The IPC does not support the change of the data retention term specified in 3.4.2 from three years to two years, as good data retention is critical to law enforcement efforts, both in the public and private sectors. *Comments of IPC submitted by Steve Metalitz and endorsed by the COA.*

### **Amendment Language:**

The ISPC, the NCSG, ECO, Demy, web.com, WS and the RrSG opposed the proposed amendment clauses, while the IPC and the ALAC generally supported them.

The ALAC is "sympathetic with the rationale for this clause. Specifically, the regular amendment

process which can and apparently does take several years, followed by up to five years delay before all registrars are subject to the new RAA is simply too long to address issues that have 'substantial and compelling need.' ICANN as the custodian of the domain name system cannot allow problems that undermine the public interest to exist without taking action .... That being said, the concept of a unilateral change is not one that many in At-Large feel comfortable with." *Comments of the ALAC submitted by Alan Greenberg.*

The IPC "strongly supports in principle the alternative amendment procedure. For entities accredited by ICANN to be able to exercise veto power over changes to the accreditation standards that ICANN concludes, after an open and transparent process, are necessary to protect the public interest, is simply unsustainable. ... However, the IPC also recognizes the concerns expressed by some registrars about the scope of this provision." *Comments of the IPC, submitted by Steve Metalitz and endorsed by the COA.*

CR is specifically concerned regarding granting "the ICANN board the unilateral right to amend the contract as it sees fit. Not only does it seem unfair to include a provision giving one party the opportunity to approve amendments unilaterally, it is also a section that wouldn't be recognized by German courts." *Comments of Cronon, submitted by Michael Shohat, also supported by 1&1.*

1&1 expressed "concern and dismay that the proposed unilateral right to amend a contract is absolutely not acceptable as a contractual term as such as well as a first step to undermine and endanger ICANN's multi stakeholder bottom-up consensus policy model which is the fundamental basis of ICANN legitimacy." *Comments of 1&1 submitted by Tom Keller.*

"Unilateral amendments, even less than bilateral contractual negotiations are not the place to set policy for a multi-stakeholder environment. The unilateral decision-making in this foundational agreement undermines our ability to advocate for multi-stakeholder governance in the ICANN model in other fora. The Internet is, by definition, a community of networks. To create a single point of unilateral decision-making, particularly when no clear case for this has been made, is contrary to this very basic and profoundly important architectural feature." *Comments of Wendy Seltzer, Joy Liddicoat, Robin Gross, submitted by WS, and endorsed by the NCSG.*

DM notes "ICANN's stated concern that the market may develop in a way that is not in the interests of the public and then registrars may seek to resist contract changes that are for the good of the end user. This is a very worthy sentiment, however what is to protect registrars or the end user if the ICANN model itself develops in a way that is not in the public interest but only the ICANN board has the power to make unilateral changes without constraint? ICANN is at best overlooking the problems and at worst being disingenuous with the implications of this requirement." *Comments of DM submitted by Gordon Dick.*

DM has "no contention with any consumer or end user protection measures being put in place through a consensus driven model even where only a minority of registrars support the wider consensus. Given the variety of registrar business models if all registrar business models equally

reject a change then we would suggest it is likely to be unworkable and thus in the overall scheme not in the public interest. *Comments of DM submitted by Gordon Dick.*

Web.com agrees with the RrSG that the proposed language, which empowers the ICANN Board to make unilateral changes to the RAA, creates an unnecessary level of risk and uncertainty for commercial operators such as Web.com. While recognizing that “ICANN has presented the amendment language as a proposal, a starting point for the conversation,” ICANN should delete this proposed change from the RAA. Indeed, if “perpetual” renewal terms are the true source of concern for ICANN, then perhaps greater attention should be dedicated to the term and termination provisions in the RAA, as opposed to insertion of a unilateral amendment provision. *Comments of Bob Weigand on behalf of Web.com.*

Web.com supports the Registrar NT Proposed Text for Section 6.7.2 which defines the term “Registrar Approval” and requests that ICANN accept this proposed change to the RAA. *Comments of Bob Weigand on behalf of Web.com.*

### **Substituting a New Agreement on Renewal**

Adoption of any future Updated RAA by the Registrar is optional up until the point of expiration and renewal. In order to avoid an uneven landscape, where not all accredited Registrars are bound by the same RAA, ICANN should consider incentives to correct this discrepancy or, alternatively, mandatory adoption of any future Updated RAA upon a reasonable notice period to the Registrar. *Comments of the IPC, submitted by Steve Metalitz and endorsed by the COA.*

### **Termination Language**

The IPC commends the drafters for the addition of language addressing several new bases for termination of the proposed 2013 RAA—particularly those related to cybersquatting. It is absolutely vital that ICANN reasonably exercise these new provisions, because they are meaningless absent any real threat of enforcement. *Comments of the IPC, submitted by Steve Metalitz and endorsed by the COA.*

### **Definition of Applicable Law**

The phrase “applicable law(s) is not defined in the proposed RAA language. When the phrase is used in reference to commercial use of a Registered Name, LS believes that it is critical to clarify that “applicable laws” includes the laws and regulations of any jurisdiction where the registrant is using the website to engage in commercial activity and/or target customers. *Comments of LS submitted by John Horton.*

### **Audits**

ICANN should define these audit requirements in terms of working days in the registrar's head quartered jurisdiction. DM is concerned that ICANN taking a view of a strict number of calendar

days does not take into account regional norms. *Comments of DM submitted by Gordon Dick.*

## **WHOIS**

The IPC, IACC, COA, BK and BS generally believe that the new obligations did not go far enough. On the other hand, the NCSG, Cronon AG, and generally believe that the obligations go too far.

The ALAC is particularly pleased to see the new sections on Privacy and Proxy registrations; resellers; the Whois Accuracy Program Specification; uniformity of Whois; and a clear, concise simple-language statement of registrant rights and responsibilities. *Comments of the ALAC submitted by Alan Greenberg.*

The IACC applauds ICANN's efforts to correct deficiencies in the quality of WHOIS information and, in particular, addition of the proposed added specification to on WHOIS verification. *Comments of the IACC, submitted by Andy Coombs.*

The ALAC supports the ICANN position of using all available information in addressing Whois Accuracy, not solely that which is in the current Whois record. *Comments of the ALAC submitted by Alan Greenberg.*

Of concern to the IPC is that Section 3.2.1 of the RAA states that "even its minimum requirements could be changed by agreement between the Registry and Registrar, if the agreement is approved by

ICANN.... While we respect the desire for registry operators and registries to modify, with ICANN's blessing, some contractual provisions under some circumstances, the IPC believes that the elements set forth in 3.2.1 must remain static and represent the bare minimum set of data elements to be furnished by Registrars to the Registry." *Comments of the IPC, submitted by Steve Metalitz and endorsed by the COA.*

With regard to Whois Accuracy Program Specification 1e – Information availability, the ALAC is unsure of the subtle difference in meaning between "made available" and "readily available". If the issue being addressed by the Registrars is a matter of cost or effort required to avail oneself of the information, that should be made much clearer and not rely on the vague term "readily" which is too subject to varying definitions. *Comments of the ALAC submitted by Alan Greenberg.*

IPC supports the first four validation requirements, and notes that all could be accomplished in an automated fashion in close to real time upon receipt of the Whois information from the registrant. With respect to 1(e), IPC supports the text proposed by ICANN. The standard of requiring validation of postal address fields only if the data "readily available" is subject to gaming. IPC recognizes that such data is not equally available for all countries but registrars should be obligated to make a diligent effort to obtain and use such data for validation. Also, the validation requirement should be expanded so that the street address is validated as to whether the numerical address exists on that street. *Comments of the IPC, submitted by Steve Metalitz and endorsed by the COA.*

IPC strongly urges that the final word of 1(f)(i) be changed from “or” to “and.” The probability of identifying a bad actor increases significantly if both the e-mail address and phone number are checked. *Comments of the IPC, submitted by Steve Metalitz and endorsed by the COA.*

With regard to Whois Accuracy Program Specification 5 – Whois inaccuracy remedy, the ALAC believes that the start of this section is too vague. In particular, the word “occurrence” is undefined subject to misinterpretation. The ALAC suggests replacing the beginning of the sentence with “Upon a validated report or discovery of a...”, or alternately, “Upon learning of a...” *Comments of the ALAC submitted by Alan Greenberg.*

The wording of Section 3 is ambiguous in some respects. “Possession of facts” and “possession of ... knowledge of circumstances” are somewhat strange locations. The standard should be whether the registrar has received information suggesting that the contact information, even though previously validated or verified, is no longer accurate or current. *Comments of the ALAC submitted by Alan Greenberg.*

The IPC notes that the verification language is defective. In a case in which verification has not been achieved, it provides the registrar the option to “verify the applicable contact information manually,” with no time limit or explanation of what is required. This means that a registration with unverifiable e-mail or phone contact information could remain active for weeks or months, until “manual” verification is carried out. Instead, registrars should be required, at a minimum, to suspend the registration until there is verification. *Comments of the IPC, submitted by Steve Metalitz and endorsed by the COA.*

The verification language should clearly set forth what should be done when contact information cannot be validated, per section 1(a)- (e). The treatment should be the same – at least suspension until validation occurs. *Comments of the IPC, submitted by Steve Metalitz and endorsed by the COA.*

Section 2 of the WHOIS Accuracy Specification conforming changes to be made. As with initial verification and validation, there is no reason why it should take 15 days for registrars to complete this process. The defects noted above concerning unvalidatable information and the results of failure to validate or verify should also be corrected. *Comments of the IPC, submitted by Steve Metalitz and endorsed by the COA.*

Given tools available to registrars, a deadline for validation and verification does not need to be nearly so long as the proposed 15 days. *Comments of IACC, submitted by Andy Coombs.*

IPC supports the inclusion of customer account holder information as subject to verification (as per ICANN proposed text). This data, which registrars have strong incentives to keep accurate and current, is useful in pursuing enforcement activities, even though it generally is not currently publicly accessible via registrar Whois. *Comments of the IPC, submitted by Steve Metalitz and endorsed by the COA.* IACC supports proposals to make account holder information subject to verification.

*Comments of IACC, submitted by Andy Coombs.*

IPC believes that registrars should be required to validate and verify domain name registration data before registrations go live. However, in the event that this is not achievable, we believe the time frame for required validation and verification should be much shorter than the 15 days proposed. *Comments of the IPC, submitted by Steve Metalitz and endorsed by the COA.*

The IPC notes that there is also a mismatch in Section 4 between the category of incorrect information identified (sections 1(a) through 1(g)) and the type of reverification required (e-mail address only). If the physical address is incorrect then reverifying e-mail will not cure the problem. *Comments of the IPC, submitted by Steve Metalitz and endorsed by the COA.*

DM notes that it has a greater knowledge of its clients and their business model than the average registrar yet ICANN will add greater costs to its business model by duplicating an authentication process it already have in place with one that will not add any value and is more open to abuse. DM wholeheartedly endorses ICANN's wish to require registrars know their customers and cooperate with law enforcement where they legally can but to prescribe a flawed method will not help the situation. *Comments of DM submitted by Gordon Dick.*

IPC agrees with Section 3.7.8 that Registrars should comply with the obligations of the Whois Accuracy Program Specification, but believes that those obligations should be considerably strengthened. *Comments of the IPC, submitted by Steve Metalitz and endorsed by the COA.*

IPC strongly supports Section 5 which for the first time specifies when registrars must cancel, suspend or render unresolvable (by placing on Client Hold status) registrations based on false contact data. It should be accompanied by a savings clause spelling out that nothing in the specification prevents a registrar from cancelling, suspending or placing on Client Hold a registration for any other reason consistent with its terms of service or contract with registrants. *Comments of the IPC, submitted by Steve Metalitz and endorsed by the COA.*

IACC supports the language which provides that registrars must take action to block resolution of domain names where registrations based on false contact data. The specification should expressly provide that it does not prevent a registrar from taking action at any time when it has a reasonable basis to believe that false contact data was supplied. *Comments of the IACC, submitted by Andy Coombs.*

IPC supports the concept of review of the Specification, but this should not be an opaque and bilateral consultation between ICANN staff and the Registrar Stakeholder Group. Other stakeholders that rely on access to accurate Whois data, including but not limited to intellectual property interests, must have an opportunity to be meaningfully involved. *Comments of the IPC, submitted by Steve Metalitz and endorsed by the COA.*

IPC agrees that customer account holder information need not be verified if it is not correlated with any active domain name registration. *Comments of the IPC, submitted by Steve Metalitz and endorsed*

by the COA.

COA strongly supports inclusion of a data item identifying the reseller in the Registration Data Directory Specification, if any, associated with a registration (see section 1.4.2). This should include contact points for the reseller. *Comments of the COA, submitted by Steve Metalitz.*

COA strongly supports the requirement to link to the ICANN Whois Data Problem Reporting System (or its successor) in registrar Whois output. The link should be required to be accompanied by the phrase “To report inaccurate or incomplete data in this report:” or words to that effect. *Comments of the COA, submitted by Steve Metalitz.*

Regarding the SLA, DM is concerned that the SLR defined by the SLAs in this clause is unreasonable and out of the control of the registrar. They may also discriminate against Registrars from countries with poorer connections to the internet. DM accepts and agrees “with law enforcement on the need for the service but rather than implementing via a strict SLA model perhaps the stick could cater for registrars being able to comply by making all reasonable efforts to match the SLA?” *Comments of DM submitted by Gordon Dick.*

The RAA needs language to ensure that when a individual files a WHOIS complaint and the registrar takes action that they not seize the domain from the original registrant and then re-sell it for their own profit. It needs to be clear that registrars need to delete domains whenever they fail to be brought into compliance by the registrant. *Comments of BK.*

The RAA WHOIS Accuracy portion should require all registrars to list a point of contact at their company who can handle WHOIS compliance issues. In addition, there should be some automated form at every registrar site to allow receipt of complaints in addition to the already existing Internic tool. *Comments of BK.*

COA’s view is that any directive from ICANN for registrar to implement a new directory service in accordance with a standard promulgated by IETF in the future must be issued only after a full opportunity for public comment on the standard and whether ICANN should require it. *Comments of the COA, submitted by Steve Metalitz.*

The ISPC supports the requirement the of a contact point at the registrars to handle WHOIS compliance issues. *Comments of ISPC, submitted by Wolf Knoblen-Ulrich.*

LS believes that there are important reasons to retain some type of bulk WHOIS access requirement, and urges the retention of a general requirement that Registrars be required to provide bulk WHOIS access with weekly updates in limited circumstances. *Comments of LS submitted by John Horton.*

Web.com requests the removal of the third-party bulk access obligations outlined in Section 3.3.6 of the proposed RAA. The competitive circumstances underlying the bulk access mandate (the existence of a single registrar model) no longer exist, thus this provision is no longer relevant. Upon removal of this provision, we would not oppose an ability by ICANN to re-impose the requirement in response to changes in the competitive landscape. *Comments of Bob Weigand on behalf of Web.com.*



## Privacy/Proxy Specification

The IPC supports the requirement for Resellers and Registrars to comply with “any ICANN-adopted Specification or Policy that establishes a program for accreditation of individuals or entities who provide proxy and privacy registration services. *Comments of the IPC, submitted by Steve Metalitz and endorsed by the COA.*

The IPC supports the addition of the proposed interim specification on privacy/proxy services (“Interim Specification”). The serious problems created by unregulated privacy/proxy services has been the subject of repeated comment from the IPC, which has repeatedly urged ICANN to address these issues in connection with negotiation of the amended RAA. *Comments of the IPC, submitted by Steve Metalitz and endorsed by the COA.*

The IACC strongly believes that the proposed specification to address proxy/privacy services should be included in the RAA Amendments. *Comments of the IACC, submitted by Andy Coombs.*

“The European Privacy law is very strict, and in general limits the amount of customer data you are allowed to collect to data that is required for billing purposes. Even forcefully collecting for example a phone number, or even an address where it is not needed, is prohibited. Since it is already widespread practice to simply violate these laws, and most people and citizen have given up on fighting for their privacy rights, I am even more worried about section 3.3.2: You want to force privacy registrars to submit a copy of all customer data to the ICANN or an escrow service... I really don't see why this is necessary. Again, this is very likely against European privacy laws, and apart from that me as a registrar would want the assurance and ability to check on the escrow service's handling of data, and require it to be in my country or a country of my choosing....I urge you to completely drop 3.3.2.” *Comments of MB.*

“The proposed accreditation of privacy services and proxy registration providers, along with new data collection and retention demands, has come under much criticism -- it is vital that human rights implications of such changes be taken into account... Such provisions must be subject to the rule of law, due process and take into account registrants rights such as to freedom of association and freedom of expression. Even a placeholder for this policy is inappropriate at this stage.” *Comments of Wendy Seltzer, Joy Liddicoat, Robin Gross, submitted by WS and endorsed by the NCSG.*

There should be no privacy or proxy registration unless (1) the privacy/proxy service is treated as the owner of the domain name; and (2) the public is the 3rd party beneficiary of the contracts for the purpose of 3.7.7.3 of the RAA. *Comments of BS.*

Web.com does not support the proposed language in Section 3.14 which obligates Registrars to “...comply with ICANN-adopted Specification or Policy that establishes a Proxy Accreditation Program” and “agree to comply with the Specification on Privacy and Proxy Registrations attached hereto” [Emphasis Added]. *Comments of Bob Weigand on behalf of Web.com.*

The IPC believes that the Privacy/Proxy Specification could be clearer in insuring that its terms apply to registrars, their affiliates, and to third parties in privity with the registrars (e.g., resellers). *Comments of IPC, submitted by Steve Metalitz and endorsed by the COA.*

While paragraph 2 appears to suggest the specification should equally apply to “affiliates” and “resellers”, the language of paragraph 3 is not equally clear. This language should be reconciled to make clear that "Registrar" includes "Resellers and Affiliates". *Comments of the IACC, submitted by Andy Coombs.*

Although the Privacy/Proxy Specification does impose an obligation to escrow customer information, it does not appear to impose any obligation upon privacy/proxy providers to verify such information. This is a fundamental flaw. *Comments of IPC, submitted by Steve Metalitz and endorsed by the COA. Comments of the IACC, submitted by Andy Coombs.*

If the customer cannot be contacted using the “revealed” data, the registration should be subject to suspension or cancellation on the same basis as if the data had been submitted to the Registrar as Whois data. *Comments of IPC, submitted by Steve Metalitz and endorsed by the COA.*

The IPC believes that there is no justification for a five day window for fulfillment of the relay obligation in paragraph 3.4. The provision already specifies a limitation where legal prohibition prevents relay, but in the context of the harms which may be at issue and the means of communication available, there seems little if any reason for a delay of "up to five days" before relaying notices received by privacy/proxy services. *Comments of IPC, submitted by Steve Metalitz and endorsed by the COA; Comments of the IACC, submitted by Andy Coombs.*

### **Business Dealings With Registrants**

The IPC “applauds the change to Section 3.7.7 which requires Registrars to enter into agreement with a Registered Name Holder other than the Registrar and enforce compliance with the provisions of the registration agreement. If vigorously enforced by ICANN, this could be a significant step toward the goal of reducing the instances of non-compliance by registrants who flout current rules and regulations due to a lack of effective enforcement provisions in the existing RAA....However, the IPC would like to see, at least as a best practice, Registrars adhere to a stricter requirement than 3.7.7’s “commercially reasonable efforts” to enforce compliance with the provisions of the registration agreement between Registrar and any Registered Name Holder (that relate to implementing 3.7.7.1 through 3.7.7.12).” *Comments of IPC, submitted by Steve Metalitz and endorsed by the COA.*

While strongly supportive of the requirement that registrars enforce compliance with the provision of the registration agreement, this requirement must be vigorously audited and enforced by ICANN if it is to be meaningful. Registrars should be required to provide ICANN with copies of their then-current standard registration agreements, and to respond to reasonable ICANN inquiries regarding their enforcement. *Comments of COA, submitted by Steve Metalitz.*

### **Domain Name Dispute Resolution**

The IPC supports the requirement for Registrars to comply with the Uniform Rapid Suspension (URS) procedure and is pleased to see this new rights protection mechanism incorporated into the RAA. Furthermore, because of the questionable track record of some resellers in cooperation with the UDRP process, the IPC recommends that it be spelled out in this section that Registrars must ensure compliance by their resellers with UDRP and URS obligations. *Comments of IPC, submitted by Steve Metalitz and endorsed by the COA.*

### **Reseller & Other Third Parties**

The IPC supports the changes to this section holding Registrar responsible for the compliance of its Resellers and third parties providing Registrar Services, and further supports the requirement for a written agreement between Registrar and Resellers. The IPC further commends the requirements for Registrars to take reasonable steps to enforce agreements with Resellers in an effort to cure non-compliance. However, in light of the significance and potential impact of this provision the IPC would support changing it to require Registrars to take “all necessary steps” to enforce these obligations. *Comments of IPC, submitted by Steve Metalitz and endorsed by the COA.*

### **Abuse Point of Contact**

The IPC is pleased to see the addition of a requirement for Registrars to provide a publicly designated contact for reports of abuse including “Illegal Activity” and requiring prompt steps to investigate and respond to these reports. The IPC is also supportive of the designated provisions for tracking and publishing these reports. The IPC believes there should be performance standards identified here for responding promptly to reports of illegal activity and abuse by those who are not law enforcement or acting on behalf of the government. *Comments of IPC, submitted by Steve Metalitz and endorsed by the COA.*

The abuse contact available to the general public under section 3.18.1 should be subject to requirements similar to those applicable to the law enforcement agency abuse contact. *Comments of COA, submitted by Steve Metalitz.*

### **Compliance Sanctions**

ICANN should have the authority to impose, as sanctions for violations of particular RAA provisions, curative measures going beyond standard RAA requirements. *Comments of COA, submitted by Steve Metalitz.*

### **Treatment of Expert Working Group Output**

From the Board resolution, “it is clear that the intent was that the Expert Working Group’s conclusions be funneled into a PDP, and it seems premature to have the RAA use the Special Amendment process without at least starting the PDP. It would be reasonable to allow the Special Amendment process (or what may replace it in light of the earlier comments) to be used when and if it is apparent that the PDP was not progressing with a reasonable chance of a suitable outcome.”

*Comments of the ALAC submitted by Alan Greenberg.*

IPC supports the ICANN proposal that implementation of the new directory service model should not be delayed pending completion of a PDP. However, the wording of this provision needs to be modified to clarify that a new model “emerges from this effort” only upon approval by the ICANN Board after a full opportunity for public comment (including reply comments and a reasoned and comprehensive response by ICANN to comments received). *Comments of IPC, submitted by Steve Metalitz and endorsed by the COA.*

### **Process for Local Law Exceptions**

ICANN is currently unclear on what it believes will be a 'trigger event' to vary the contract when it conflicts with national law. ICANN cannot through its contract require a registrar to breach applicable law. Therefore the only trigger event can be the registrar's reasonable belief that in carrying out the action would put them in breach of the law. *Comments of DM submitted by Gordon Dick.*

### **Elimination of Port 43 obligations for Thick Registries**

Supporters for the elimination of Port 43 obligations include the RrSG, web.com, and DM. On the other hand, the ISPC and the IPC support maintaining the current registrar obligations with respect to Port 43.

ALAC does not have a strong position on this, but some members believe that in the absence of a compelling reason from ICANN as to why the port 43 service should be maintained for thick registries, the registrar position is reasonable. *Comments of the ALAC submitted by Alan Greenberg.*

DM notes that it has “not seen ICANN publicly identify its rationale for requiring registrars to duplicate the WHOIS service provision for thick registries.” In the current situation there is differing information in the registrar's WHOIS from the registry WHOIS. This simply adds to confusion and lack of clarity to the general public as well as adding cost that is passed on to the registrant. Adding cost for no tangible benefit is not in the interests of registrants, law enforcement authorities or internet users. *Comments of DM submitted by Gordon Dick.*

Requiring both Registrars and “thick” Registries to provide free public query-based port 43 access creates duplicative efforts and unnecessary expenses for all parties. It also creates uncertainty as to the authoritative source for the port 43 Whois service, exacerbated by rare instances where inconsistent registration data exists at the Registry and Registrar levels. *Comments of Bob Weigand on behalf of Web.com.*

The IPC notes that “[t]he provisions of 3.2.1 set forth data elements that a Registrar is required to submit to the Registry, such as the name, IP addresses and names of primary and secondary name servers, identity of the Registrar, and expiration date of the registration. These elements are required today, and, while better verification of those elements needs to be provided for under the RAA, the IPC naturally supports the requirement to continue to provide this data. Since the overwhelming majority of registries in which registrars will sponsor registrations pursuant to this agreement will be “thick” registries, it would make more sense to include the full list of data elements (as in section 3.3)

in this section, with the statement that the list could be reduced to the six elements listed here solely in the case of “thin” registries, of which there are only 3.” *Comments of IPC submitted by Steve Metalitz and endorsed by the COA.*

The IPC supports the continued provision of Port 43 Whois service for all gTLDs, and is concerned that present day access is threatened by the new mechanism in 3.3.1 that allows Registries to enter into agreement with the gTLD Registry operator and, with the approval of ICANN, provide “alternative” data elements. *Comments of IPC submitted by Steve Metalitz and endorsed by the COA.*

### **Scope of Consensus Policy Development**

With regard to the Consensus Policies 1.2.4 – taking into account use of domain name, although the ALAC understand the possible difficulty of having a registrar analyze the usage of a particular domain, one cannot totally ignore such usage either. Any policy that includes the requirement to factor in use of a domain name may be difficult to craft so that it can be effective, but the RAA should not preclude such efforts. *Comments of the ALAC submitted by Alan Greenberg.*

With regard to the Consensus Policies 1.3.4 – Details of accuracy and up-to-date specification, “it is unclear what the effect would be of the Registrar request to omit the detailed list of issues that are subject to Consensus/Special Policy. If the omission implies that such issues would be out-of-bounds for future policy, the ALAC does not agree.” *Comments of the ALAC submitted by Alan Greenberg.*

The IPC “also notes, and opposes, the proposed change to 3.3.4. Under this revised provision, Registrars could be required to contribute data to a cross-registrar Whois service if (and only if) ICANN adopts a Consensus Policy to that effect. Given the historical pace of ICANN’s consensus policy development, this change to the RAA effectively forecloses the hope of a timely implementation of a cross-registrar Whois service – even if a majority of Registrars decide to support and provide it.” *Comments of IPC submitted by Steve Metalitz and endorsed by the COA.*

The IPC concerns are deepened by the “Registrar proposal to remove from the list of topics that are appropriate for consensus policies both ‘the development of a distributed capability that provides query-based Whois search functionality across all registrars’ and ‘the development of a centralized Whois database for the purpose of providing comprehensive Registrar Whois search capability.’” *Comments of IPC submitted by Steve Metalitz and endorsed by the COA.*

### **2013 RAA required for New gTLD Program**

The RrST notes that “in addition to the new items for inclusion there was a surprise announcement that all new gTLD registries must only use registrars that have signed the 2013 RAA, a transparent effort by ICANN to arbitrarily link the new gTLD program to the outcome of RAA negotiations. This requirement would create separate ‘classes’ or ‘levels’ of registrars, which is unprecedented in the DNS industry. There can and must be only one meaning of ‘ICANN-Accredited.’” *Comments of the RrSg submitted by Michele Neylon.*

NBC “strongly supports ICANN’s position that the RAA must be finalized before new gTLDs are

approved. The RAA represents one of the most important checks against DNS abuse in what will be a massively expanded Internet addressing system. Beginning that expansion before the RAA is firmly in place dramatically increases the risk of abuse and exploitation of the new gTLD program. Because the ongoing success of the new gTLD program will be determined, in large measure, by the effectiveness and stability of its launch, it is critical that all appropriate protections be in place before that process begins.” *Comments of NBC Universal, submitted by Meredith Baxter.*

The ISPC supports the request that all registries for new gTLDs use registrars having signed the 2013 RAA. *Comments of ISPC, submitted by Wolf Knoben-Ulrich.*

### **Assignment of the RAA**

With respect to assignment of registrar accreditation, while assignment to another accredited entity that already (and in a compliant manner) acts as a registrar poses fewer risks than assignment to a third party not currently engaged in the registrar business, COA disagrees that such a transaction should automatically be approved unless ICANN formally objects within 10 calendar days. *Comments of COA, submitted by Steve Metalitz.*

## **Section IV: Analysis of Comments**

*General Disclaimer: This section is intended to provide an analysis and evaluation of the comments received along with explanations regarding the basis for any recommendations provided within the analysis.*

Although the comments submitted reflect many valuable insights, it may difficult to incorporate them in the final 2013 RAA, as the document posted reflects many hard-fought compromises between the negotiation teams. However, some of the concerns raised in the public comment period will be reflected in the future version of the RAA. For example, the community concern raised in regards to what was previously referred to as the “unilateral” amendment clause have been taken into account, and the Board-approved amendment process has been revised to include substantial procedural protections, including the opportunity for the Registrars to proposed alternative amendment language. In addition, ICANN and the Registrar NT have developed a path towards negotiations – an element missing from prior versions of the RAA – to allow for either side to raise issues for consideration.

In terms of data retention issues and the process for local law exemption, ICANN and the Registrar NT have developed a path forward that allows for registrars to seek waivers from ICANN prior to having a proceeded initiated in the event that an obligation from the RAA would cause a registrar to violate the laws under which it operates.

On Port 43 obligations for Thick Registries, the comments received did not evidence vast support or lack of support for either ICANN or the Registrar NT provision. As a result, ICANN has agreed to remove the Port 43 obligations as they relate to thick registries. On other Whois items, the reference to the output of the Expert Working Group has been removed from the agreement, as mentioned in

the comments, and ICANN and the Registrar NT have maintained the Whois SLA. In terms of the other recommended solutions for Whois-related issues, given the ongoing work of the Expert Working Group, the Registrar NT and ICANN did not engage in further negotiations to bring in some of the ideas raised, such as further refining validation requirements. For each of these ideas, as well as the comments on how the privacy/proxy specification should be expanded or reduced, the forthcoming policy-related work on these items are a more appropriate venue for these recommendations. While further enhancements could be achieved in these areas, the anticipated future policy development work will be a more appropriate venue to continue considerations of the balance of need, cost and public impact of the suggested changes.

For the Consensus Policy specification, ICANN confirmed that there would be no diminishment in requirements to follow consensus policies on some of the enumerated topics, and therefore removed the list of items from the specification in favor of the items remaining within the RAA. On the issue of “use” of the domain name, the Registrar NT and ICANN agreed to not change the language and remain with the phrase that has previously been included within the RAA.

The additional revisions to the RAA, as described here, will be posted shortly for a public comment period which will provide an additional opportunity for the ICANN community to provide input and commentary.

Please note that there may be one or more GNSO policy development processes (PDP) initiated to address several of the topics raised during this public comment. For example, ICANN has committed to re-initiate work towards a Proxy/Privacy Accreditation Program. In addition, while many of the comments submitted in this public form address inadequacies in the current WHOIS system, full evaluation of these suggestions has been deferred due to the upcoming PDP on Data Directory Services. This PDP has been requested by the ICANN Board to identify a replacement for the current WHOIS protocol, and as a result, ICANN has convened an expert working group (EWG) for this purpose. When the EWG concludes its work and delivers a proposal for a new system of Data Directory Services, the GNSO will have an opportunity to commence a PDP to evaluate the policy implications of the new system & make recommendations to the ICANN Board. Further revisions to the WHOIS related obligations in the draft 2013 RAA were viewed as inappropriate in light of this pending work.

