

12



AD A115440

# DEFENSE ADVANCED RESEARCH PROJECTS AGENCY

## A HISTORY OF THE ARPANET:

### The First Decade

1 April 1981

DTIC  
ELECTE  
JUN 10 1982  
S D I  
E

APPROVED FOR PUBLIC RELEASE  
DISTRIBUTION UNLIMITED

(Prepared for DARPA by Bolt Beranek and Newman, Inc.)

1400 WILSON BOULEVARD ARLINGTON, VIRGINIA 22209

82 06 10 044

DTIC FILE COPY

Vertical text on the left edge of the page, possibly a barcode or tracking information.

Report No. 4799

A HISTORY OF THE ARPANET

The First Decade

APPROVED FOR PUBLIC RELEASE  
DISTRIBUTION UNLIMITED

April 1981



Accession For	
NTIS GRA&I	<input checked="" type="checkbox"/>
DTIC TAB	<input type="checkbox"/>
Unannounced	<input type="checkbox"/>
Justification	
By _____	
Distribution/	
Availability Codes	
Dist	Avail and/or Special
A	

Table of Contents

I. EXECUTIVE SUMMARY	I-1
II. THE ARPANET PROJECT - OBJECTIVES AND RESULTS;	II-1
1. Program Objective and Technical Needs	II-2
1.1 Defense Program Addressed	II-2
1.2 State of the Art at Program Inception	II-5
1.3 Specific Technological Problems Addressed	II-7
1.4 Expected Payoff/Time-Frame/Costs	II-7
2. Program Description and Evolution	II-10
2.1 Program Structure	II-10
2.2 Major Technical Problems and Approaches	II-12
2.3 Major Changes in Objectives and Approaches	II-19
3. Scientific and Technical Results and Accomplishments	II-21
3.1 Results of the Effort in Relation to the Program Objectives	II-21
3.2 Technical Aspects of the Effort Which Were Successful and Aspects of the Effort Which Did Not Materialize as Originally Planned	II-23
4. Applications and Considerations for the Future	II-28
4.1 Conclusions of Technical Feasibility	II-28
4.2 Recommendations on Additional R&D Requirements and Opportunities	II-28
5. Program Impact and Assessment of Technology Developed	II-31
5.1 Service Use of Technology	II-31
5.2 Impact on Non-DoD Programs	II-31
5.3 Applications of the Program Results	II-32
5.4 Advance in the State-of-the-Art	II-32
6. Bibliography of Reports	II-33

III. A HISTORY OF THE ARPANET PROJECT,	III-1
1. History	III-2
1.1 Background	III-5
1.1.1 The RAND Study of Distributed Communications Networks	III-5
1.1.2 The Lincoln/SDC Experiment	III-9
1.1.3 The NPL Data Network	III-11
1.2 The Events of 1967 and 1968	III-14
1.3 Key Aspects of the RFQ	III-18
1.4 Chronological Development, 1969 to 1975	III-24
1.4.1 The Groups and the Key People	III-25
1.4.1.1 Management and Administration of the Network: DARPA/IPTO, DSS-W, RML, and DECCO	III-26
1.4.1.2 The Network Analysis Corporation	III-29
1.4.1.3 The Telephone Companies	III-32
1.4.1.4 Bolt Beranek and Newman Inc.	III-35
1.4.1.5 The Network Information Center	III-36
1.4.1.6 The Network Measurement Center	III-39
1.4.1.7 The Network Working Group and Host Involvement	III-45
1.4.2 Initial Subnet Design	III-48
1.4.3 Subnet Development	III-53
1.4.4 Host Protocol Development	III-58
1.4.4.1 Host-to-Host Protocol	III-61
1.4.4.2 The Evolution of TELNET	III-64
1.4.4.3 The Evolution of Other Host Protocols	III-68
1.4.5 <sup>and</sup> Network Growth -- A Summary.	III-72
1.4.5.1 Traffic Growth	III-72
1.4.5.2 Topology	III-76
1.4.5.3 Hosts	III-91
1.5 The Impact of the ARPANET	III-94
1.6 Maturity and Handover to DCA	III-104

2. Observations	III-106
2.1 Social Issues	III-107
2.2 Technical Lessons	III-112
2.2.1 Terminal Handling	III-113
2.2.2 Reliability and Fault Isolation	III-119
2.2.3 Maintenance Management	III-122
Appendices	
A. BBN ARPANET Bibliography	A-1
A.1 Technical Reports	A-1
A.2 Published Papers	A-3
B. Selection of ARPANET Logical Maps	B-1

Report No. 4799

Bolt Beranek and Newman Inc.

CHAPTER I: EXECUTIVE SUMMARY

## 1. EXECUTIVE SUMMARY

In fiscal year 1969 a DARPA program entitled "Resource Sharing Computer Networks" was initiated. The research carried out under this program has since become internationally famous as the ARPANET.

This DARPA program has created no less than a revolution in computer technology and has been one of the most successful projects ever undertaken by DARPA\*. The program has initiated extensive changes in the Defense Department's use of computers as well as in the use of computers by the entire public and private sectors, both in the United States and around the world. Just as the telephone, the telegraph, and the printing press had far-reaching effects on human intercommunication, the widespread utilization of computer networks which has been catalyzed by the ARPANET project represents a similarly far-reaching change in the use of computers by mankind. The full impact of the technical changes set in motion by this project may not be understood for many years.

In 1975 the ARPANET was successfully transferred to the Defense Communications Agency which has operated it since that time.

\* Defense Advanced Research Projects Agency (DARPA)

Report No. 4799

Bolt Beranek and Newman Inc.

CHAPTER II: THE ARPANET PROJECT - OBJECTIVES AND RESULTS



## 1. PROGRAM OBJECTIVE AND TECHNICAL NEED

### 1.1 Defense Program Addressed

The DARPA program had the following objectives: (1) To develop techniques and obtain experience on interconnecting computers in such a way that a very broad class of interactions are possible, and (2) To improve and increase computer research productivity through resource sharing. It was envisioned that by establishing a network tying computer research centers together, both goals would be achieved. In fact, the most efficient way to develop the techniques needed for an effective network was thought to be by involving the research talent at these centers in prototype activity. Just as time-shared computer systems permitted groups of hundreds of individual users to share hardware and software resources with one another, it was thought that networks connecting dozens of such systems would permit resource sharing between thousands of users. Each system, by virtue of being time-shared, could offer any of its services to another computer system on demand. The most important criterion for the type of network interconnection desired was that any user or program on any of the networked computers be able to utilize any program or subsystem available on any other computer without having to modify the remote program.

This objective was an entirely new and different approach to an extremely serious problem which existed throughout both the Defense Department and society at large. The many hundreds of computer centers in the Defense Department and the many other thousands of computer centers in the private and public sectors operate almost completely autonomously. Each computer center is forced to recreate all the software and data files that it wishes to utilize. In many cases this involves the complete reprogramming of software or reformatting of data files. This duplication and redundant effort is extremely costly and time consuming. In fiscal year 1969 DARPA estimated that such duplicative efforts more than double the national costs of creating and maintaining the software. There had been other completely different attempts to address this problem, such as attempts at language standards for computers, attempts at standardizing the types of hardware, and attempts at automatic translation between computer languages. Although each such approach had some value and utility, the problems of trying to share computer software resources or files was truly enormous.

In addition to the general problem shared with the rest of the scientific community, the Defense Department also faces certain special problems having to do with training. Military personnel trained to use one manufacturer's equipment must often be trained again to use another's. Machines procured from

different manufacturers require as many different user training programs as there are machines, thus inhibiting positive transfer of training that could accumulate through the rotation of military personnel. Those data files and programs which have common utility to many military organizations and installations must be stored, created and maintained separately at each different machine. Military systems interconnected in a distributed interactive network obviate such constraints.

Another objective of the program was to permit the linking of specialized computers to the many general purpose computer centers. It was thought that with the then recent improvements in the hardware area, it would become most cost effective to design and construct computers efficient at specialized tasks (e.g., compiling, list processing and information retrieval). Making such machines available to all the computer research establishments would significantly increase the capability at these other centers.

This program was addressed at no less than changing the use of computers by the entire Defense Department. It was clearly intended that the use of such a computer network would permit resource sharing within and across the military services and throughout the Defense research community.

## 1.2 State of the Art at Program Inception

By the date of the program plan in the late 1960s most of the specific technologies required for a computer network had individually been achieved in some form. For example, there had been many connections of phone lines to computers (e.g., the SAGE system, Air Line reservations systems, and time-sharing systems). However, there had been only a very small number of attempts to connect computers together for the purpose of experimenting with the sharing of resources.

- o In the early 1960s an attempt was made to link computers together at the Western Data Processing Center at UCLA for the purpose of enabling similar computers to perform load sharing. A similar experiment was also performed at Bell Laboratories and achieved reasonable success for several years.
  
- o A number of networks were constructed for the primary purpose of message handling, including a Westinghouse inventory control system and several air line reservations networks. The SITA network for air line reservations was surprisingly advanced in concept in the mid-1960s, but details about SITA were generally not known in the U.S. computing community. In any case, the techniques used for such message systems were special

purpose in nature and were not readily transferable into the general area of inter-computer communications.

- o A direct progenitor of the ARPANET was an effort made in the mid-1960s to achieve a coupling between academic computing expertise and the operation of the SDC Q32 computer. This effort led to a phone line connection between the Q32 at SDC and the TX2 at Lincoln Laboratory, and demonstrated the relative ease of modifying time sharing systems to permit network interactions.

Aside from the technical problems of interconnecting computers with communications circuits, the notion of computer networks had been considered in a number of places from a theoretical point of view. Of particular note was work done by Paul Baran and others at the Rand Corporation in a study "On Distributed Communications" in the early 1960's. Also of note was work done by Donald Davies and others at the National Physical Laboratory in England in the mid-1960's.

In sum, at the time of the initiation of the ARPANET program in fiscal year 1969 many of the requisite ideas had been considered and many of the requisite technical bits and pieces had been attempted in some form, but no significant attempt had ever been made to put them together into a resource sharing computer network.

### 1.3 Specific Technological Problems Addressed

The technological problems of building the ARPANET can be considered at many different levels of detail. At the top level, there were really two problems:

1. To construct a "subnetwork" consisting of telephone circuits and switching nodes whose reliability, delay characteristics, capacity, and cost would facilitate resource sharing among the computers on the network.
2. To understand, design, and implement the protocols and procedures within the operating systems of each connected computer, in order to allow the use of the new subnetwork by those computers in sharing resources.

Within these two major technological problems, there were, of course, a large number of sub-problems; including the engineering of the phone circuit connections, the topology of the network, the selection of switching node equipment, the design of line disciplines to work through phone line errors. the routing problem, and many others.

### 1.4 Expected Payoff/Time-Frame/Costs

The goals for the ARPANET project were very broad and envisaged a significant eventual impact on the use of computers

in both the public and private sectors. However, in addition to these long range goals, DARPA visualized some quite specific initial payoff in the form of improved productivity of the DARPA research program itself, and a resulting cost/performance benefit to the services from DARPA research. In fiscal year 1969, a number of computer research centers throughout the country were supported in whole or in part by DARPA's Information Processing Techniques Office (IPTO). The installation of an effective network tying these locations together would substantially reduce duplication and improve the transfer of scientific results, as well as develop the network techniques needed by the military. The research output of these projects was important to all three Services and it was expected that this output could be substantially increased for the same dollar cost if a portion of the funds were utilized for the network.

In addition, initial payoff was anticipated in the form of technology transfer from the ARPANET project in three ways:

- o By dissemination of new scientific knowledge through conferences and the appropriate literature.
- o By transfer of management of the ARPANET to a common carrier, and the resulting availability of ARPANET services to other groups (such as Office of Education Regional Laboratories, NSF-supported universities, and various user groups supported by the NIH).

- o By adoption of the network technology by specific military groups (such as the National Military Command System Support Center and other military centers affiliated with it; e.g., CINCPAC, CINCEUR, and MACV).



## 2. PROGRAM DESCRIPTION AND EVOLUTION

### 2.1 Program Structure

With the initiation of the ARPANET program plan in early fiscal year 1969, DARPA began work in earnest on three parallel paths of effort: (1) to obtain the network circuits; (2) to select the system contractor for the switching nodes and the overall design; and (3) to initiate efforts within the DARPA research community for resource sharing experiments and specialized network support.

DECCO was able to handle all the contractual details with the common carriers for circuit leases. Most of the required 50 kilobit circuits used in the ARPANET were leased through DECCO from AT&T, but a small number of circuits were leased from other carriers such as General Telephone. In addition, DARPA arranged for a special point of contact in AT&T (long lines), which greatly facilitated the interactions between the network system contractor, DARPA, and AT&T. The selection of network node locations and the internode connections (and, therefore, the location of circuit terminations) was a specialized topology problem and represented a difficult theoretical problem in its own right. To help solve this particular problem, DARPA contracted with the Network Analysis Corporation (NAC). NAC had developed certain networking analysis tools and via this DARPA

support, such tools were refined; NAC's advice on topology was sought through the various stages of ARPANET growth.

A competitive procurement was planned for the selection of the contractor to design the switching nodes and act as general systems contractor. An RFP was prepared and issued in July 1968. Bolt Beranek and Newman Inc. (BBN) was selected as the systems contractor for the design of the subnetwork and the switching nodes. BBN subcontracted with Honeywell for the switching node hardware itself. Over the life of the ARPANET program from January 1969 until the transfer to DCA in July of 1975, BBN served as the systems contractor for the design, implementation, operation and maintenance of the subnetwork; BBN is still serving that role under the aegis of the Defense Communications Agency (DCA).

The research groups receiving DARPA IPTO support then began considering the design and implementation of protocols and procedures and, in turn, computer program modifications, in the various host computers in order to use the subnetwork. Several specific responsibilities were arranged: UCLA was specifically tasked to develop and run a "Network Measurement Center" with the objective of determining the performance of the network; SRI was specifically tasked to develop and operate a "Network Information Center" with the objective of collecting information about the

network, about host resources, and at the same time generating computer based tools for storing and accessing that collected information. Beyond these two specific contracts, some rather ad hoc mechanisms were pursued to reach agreement between the various research contractors about the appropriate "host protocols" for intercommunicating over the subnetwork. The "Network Working Group" of interested individuals from the various host sites was rather informally encouraged by DARPA. After a time, this Network Working Group became the forum for, and eventually a semi-official approval authority for, the discussion of and issuance of host protocols to be implemented by the various research contractors. Progress in this area was rather slow for a while, but with time, this mechanism eventually was successful in establishing effective host protocols.

## 2.2 Major Technical Problems and Approaches

In a program of this duration and complexity, it is not difficult to identify many dozens of important technical problems and approaches to those problems. We here list a few of the problems which were most technically challenging in the early few years of the ARPANET program. A few additional major technical problems will be listed in the next section on "Major Changes and Objectives".

- o TOPOLOGY - For any network of this type with even a dozen nodes, an obvious, early recognized, and quite formidable problem is topological optimization. Assuming that the node locations are known, the number of ways of arranging M links among N nodes is very large; the links are usually available in discrete sizes (bandwidth); and the component cost structures, time delay functions, and reliability functions are all typically non-linear. The design may be subject to many constraints, including maximum or average time delay, average or peak throughput requirements, and reliability requirements. The usual goal of the optimization is to provide a network design that meets all constraints at the lowest cost. The approach to this problem was to design an elaborate computer program to assist in the optimization. It is not possible to use an exhaustive approach, and instead the approach used was to generate a "starting network" and then to perform local transformations to the topology in order to reach a locally optimum network. If this procedure is repeated with many starting networks and if the resulting locally optimum networks are evaluated, it is possible to find a feasible solution with costs that are close to optimal.

- o ERROR CONTROL - A critical necessity for a resource sharing computer network was to provide reliable communication and one component of such reliability was an ability to work through the expected phone line errors on the 50 kilobit circuits. The approach taken was to design special checksumming hardware at the transmitting and receiving end of each 50 kilobit circuit in the network. As part of the switching node transmission procedure, a powerful 24 bit cyclic checksum is appended to every packet of information to be transmitted. Then, at the receiving node, the checksum is recomputed in hardware and compared with the transmitted checksum. If there is no error, an acknowledgment (with its own checksum) is sent back to the transmitting node. If there is an error, no acknowledgment is sent and the packet will be retransmitted.
  
- o HOST INTERFACE - An important issue was the proper design of an interface between the switching node and host computers of many different types. It is important to allow a logical match between the switching node computer word length and the varying word lengths of the host computers, and also to allow the input/output routines of the switching node and the input/output

routines of the host computer to service the interface "cooperatively" without placing an undue processing burden or tight timing constraints on either machine. The approach taken was to design a bit-serial interface which could logically stop after any bit, and to then require that each host computer build (obtain) a specialized small hardware unit called a "special host interface" which would be installed in the host machine itself to serve the network connection. Thus, a logical and electrical convention was specified by the switching network in a manner intended to minimize overall trouble to all hosts, then each host was required to meet that standard both in hardware and software.

- o SWITCHING NODE PERFORMANCE - A central goal of the network was to provide resource sharing between remote installations in such a way that a local user could employ a remote resource without degradation. In particular, this required that the subnetwork be sufficiently reliable, have sufficiently low delay, have sufficiently great capacity and have sufficiently low cost, that remote use would be "as attractive" as local use. These objectives translated into a major technical problem for the switching node itself to provide low

delay and high capacity at modest cost. The approach taken was to select a mini computer for the switching nodes whose I/O system was very efficient and to write very carefully tailored programs in machine language to optimize the capacity and the low delay of the data path in the switching node. Great attention was paid to minimizing the operating time of the inner loops of these programs.

- o REMOTE CONTROL - A special and new problem was posed by the need to put dozens of small identical mini computers in the field, in an environment where the host connections to those computers was somewhat experimental and where the programs in the mini computers themselves were under development and were changing from month to month. It was important to be able to do debugging of software, debugging of new host connections, program modifications, and the installation of new programs without the costs and difficulties associated with having manned sites. The approach taken was to develop an entirely new technology of remote computer management. A Network Control Center was established for the subnetwork and software was developed which made it possible to examine or change the operating software in any node of the net from the central network control

center. This approach made it possible to issue complete new versions of the software to each node in the network from a central place in an hour or two. In addition, each node reports the state of its health to the central place periodically and provides information on which to base debugging and maintenance activities.

- o ROUTING - In a non-fully connected network, an important problem is the decision process by which each node decides how to route information to reach any particular destination. This is a difficult theoretical problem and there are many different approaches, including fixed routing, random routing, centrally controlled routing, and various forms of distributed adaptive routing. The approach taken was to use a distributed adaptive traffic routing algorithm which estimates on the basis of information from adjacent nodes the globally proper instantaneous path for each message in the face of varying input traffic loads and local line or node failures. Each IMP keeps tables containing an estimate of the output circuit corresponding to the minimum delay path to each other IMP, and a corresponding estimate of the delay. Periodically, each IMP sends its current routing estimates to its neighbors; whenever an IMP receives such a message it updates its internal



estimates. Thus, information about changing conditions is regularly propagated throughout the network, and whenever a packet of traffic must be placed on the queue for an output circuit, the IMP uses its latest estimate of the best path.

- o HOST PROTOCOL - In many ways a computer network is to host computers as the telephone system is to human users: a transparent communication medium in which even after the caller has learned how to insert dimes and dial, it is still necessary that he speak the same language as the person called in order for useful communication to occur. The common language is referred to as host protocol, and the problem is to design a host protocol which is sufficiently powerful for the kinds of communication that will occur and yet can be implemented in all of the various different host computer systems. The initial approach taken involved the development of a piece of software called a "Network Control Program" which would reside in a host computer, such that processes within a host would communicate with the network through this Network Control Program. The primary function of the NCP is to establish connections, break connections, switch connections, and control flow.

A "layered" approach was taken such that more complex procedures (such as File Transfer Procedures) were built on top of simpler procedures in the host Network Control Program.

### 2.3 Major Changes in Objectives and Approaches

The ARPANET development was an extremely intense activity in which contributions were made by many of the best computer scientists in the United States. Thus, almost all of the "major technical problems" already mentioned received continuing attention and the detailed approach to those problems changed several times during the early years of the ARPANET effort. However, in addition several more major changes in objectives were introduced once the initial network became operational:

- o THE TIP - The initial nodal switching units, called IMPs, were intended to interconnect computers and high bandwidth phone lines. At the outset all terminal access to the network was via terminal connections to the hosts themselves. After a time it became clear that there was a population of users for which terminal access to the network was very desirable, but who were not conveniently able to access the network via a host computer. Thus, a new nodal switching unit, a Terminal Interface Message Processor, or TIP, was defined to

serve the purpose of an IMP plus an additional function of direct terminal access. This shift resulted in the design of a TIP which really was a tiny host embedded in a switching node itself and permitted the direct connection of up to 63 asynchronous character-oriented terminals to the switching node. The TIP became the nodal switching unit of choice, often even where there was a local host computer; this allowed connection of both hosts and terminals at that location directly to the network.

### 3. SCIENTIFIC AND TECHNICAL RESULTS AND ACCOMPLISHMENTS

#### 3.1 Results of the Effort in Relation to the Program Objectives

In some cases a major program can be seen to reach its objectives in a single instant: a mushroom cloud at Alamogordo, or Armstrong stepping onto the moon. In other cases, like the ARPANET, an equally important objective may be reached with equal success, but the event must be observed in a more complicated way and over a longer period of time. The first ARPANET objective was "to develop techniques and obtain experience on interconnecting computers in such a way that a very broad class of interactions are possible". Not just techniques, but an entire technology of packet switching has been developed, and an enormous body of experience has been developed on interconnecting computers to allow a broad class of interactions.

A second objective, which has also been attained, was to improve computer research productivity through the development of computer resource sharing.

Another objective was to permit the linking of specialized computers to the many general purpose computer centers. Several major specialized computers have been linked over the ARPANET to the main general purpose computer centers in an extremely successful fashion.

At a technological level, the overall objectives were to construct a subnetwork whose reliability, delay characteristics, capacity, and cost would facilitate resource sharing among the computers in the network; and to understand, design and implement the host protocols to permit such resource sharing. Such a subnetwork, consisting of over 50 nodes and stretching from Hawaii to Norway, was successfully constructed; and the necessary host protocols to allow resource sharing among the connected computers were successfully understood, designed and implemented.

The demonstration of initial net operation with four nodes and later the extension to 19 nodes took place on a time scale that was extremely close to the incremental time anticipated in the program that was being planned. However, as the success of the ARPANET became obvious after about two years, decisions were made to take advantage of this success and to grow the net to a size that had never been anticipated at the outset; growth to more than 50 nodes over a geographic area from Hawaii to Norway was certainly not originally anticipated. In similar fashion, the costs in the first two fiscal years of the program were very close to anticipated costs, but as decisions were made to expand the scale of the network, the cost no longer followed the original program plan.

In short, the results of the effort were eminently successful and far more than adequately met the objectives initially stated. The success of the program far exceeded even the most optimistic views at the time of inception.

### 3.2 Technical Aspects of the Effort Which Were Successful and Aspects of the Effort Which Did Not Materialize as Originally Envisaged

A representative list of the aspects of the ARPANET programs which were technical successes follows:

- o Powerful computer-based techniques for topological optimization were developed and the choice of ARPANET topology was made with the aid of these tools.
- o The carriers successfully provided high reliability 50K/sec circuits.
- o A subnetwork including nodal switching IMPs and TIPs was constructed whose performance, reliability, and cost did facilitate resource sharing.
- o The ARPANET provides a convincing demonstration that adaptive routing algorithms can be made to perform reliably (e.g., in a globally correct manner in the face of local failures), efficiently (e.g., adapting to

changes in the network quickly and accurately), and flexibly (e.g., accommodating a variety of circuit bandwidths and internode distances) without excessive complexity and overhead.

- o The ARPANET has demonstrated that it is possible to build a large operational network in such a way that the effects of component failures are localized rather than "crashing" or otherwise making non-operational large portions or all of the network. A node or a host can fail in the ARPANET and network use will be prevented for only the few users directly connected to that node or using that host.
- o The ARPANET has confirmed the theoretical result that networks which store-and-forward packets can achieve delays which are low when compared to the delays incurred in the computers (hosts) which are using the network.
- o The ARPANET has demonstrated that a network can be constructed so that nodes, lines, traffic, and so on can be added or deleted without major upheavals with each addition.

- o The ARPANET has demonstrated that it is possible for a network to control and operate itself for hours at a time without explicit control from a control center.
- o The ARPANET has demonstrated new techniques for monitoring, maintenance, and debugging. The nodes in the ARPANET typically operate at sites where there is no knowledgeable person available locally. The nodes automatically report their status (via the network itself) to a network monitoring center, and maintenance and debugging (of both the software and hardware) are typically carried out (again via the network) from the monitoring center.
- o Possibly the most difficult task undertaken in the development of the ARPANET was the attempt -- which proved successful -- to make a number of independent host computer systems of varying manufacture, and varying operating systems within a single manufactured type, communicate with each other despite their diverse characteristics.
- o A set of host protocols was hammered out between the host organizations and resulted in a layered structure of host protocols that did facilitate resource sharing.



- o The ARPANET was successfully transferred to the Defense Communications Agency.

Inevitably there were technical areas which proved less tractable than had been hoped and some kinds of network utilization developed more slowly than had been anticipated.

Problems of routing, flow control, and congestion control in the subnetwork turned out to be as difficult as theoreticians had anticipated, and the algorithms had to be modified more than the implementors had anticipated. Luckily, the improvements in the algorithms managed to stay slightly ahead of the growth in network size and traffic and, therefore, difficulties with the algorithms never represented an impediment to resource sharing on the network.

It proved more difficult to agree on the specification of adequate host protocols than had been originally hoped. However, the eventual design of the host protocols was eminently successful and provided a strong base for resource sharing.

The development of a widely-useful on-line Network Information Center (NIC) proved to be a difficult project. Although very interesting and important computer-based tools

for information handling were developed, the actual timely collection and on-line publication of detailed descriptions of resources at the various host sites proved nearly intractable. Further, the computer tools that were developed, while rather elegant, were not so clearly cost effective for wide scale remote use. Eventually, the goals of the NIC were substantially reduced and at the time of the ARPANET transfer to DCA, it was generally necessary to obtain detailed information about the resources at a particular site directly from the site.

Many different kinds of resource sharing use were anticipated at the inception of the ARPANET program. Of these, the remote use of one program by another was one of the more distant goals. While some of this kind of resource sharing has, indeed, taken place, such use has grown more slowly than other network uses.

#### 4. APPLICATIONS AND CONSIDERATIONS FOR THE FUTURE

##### 4.1 Conclusions of Technical Feasibility

The ARPANET project proved the technical feasibility of achieving reliable high performance, cost effective digital communications by means of packet switching technology and, in turn, the technical feasibility of operating a resource sharing computer network based on this technology. The ARPANET project also proved the feasibility of achieving closely knit communities of technical interest over a widespread geographic area; it is possible that this social feasibility demonstration is as important as the many technical feasibility demonstrations.

##### 4.2 Recommendations on Additional R&D Requirements and Opportunities

It is clear that packet switching networks have a very direct application to command and control and a significant research opportunity exists in attempting to investigate such command and control applications. DARPA is already proceeding to develop testbeds whereby packet switching technologies and other related technologies can be experimentally employed in cooperation with one or more of the military services. There is a clear requirement for improved command and control and the packet switching technology developed in the ARPANET provides a major opportunity to make progress towards this goal.

At a deep technical level, the proper design of host operating systems for efficient and cost effective connection to networks is still in the area of significant research and development opportunity. In the ARPANET project, the network connections were "add-ons" and it is clearly time to mount the more detailed investigation of how best to accomplish such connections.

The techniques for remote control of computers in the field developed within the ARPANET project are probably more broadly applicable to the management of computer resources in other areas of the Defense Department. These remote management techniques represent another opportunity which has grown out of the ARPANET experience.

It was earlier indicated that it was not practical for the Network Information Center in the ARPANET to keep current on-line detailed descriptions of program resources available within the host community. This difficulty in turn represents a research and development opportunity for the future. Specifically, research and development is required on how to properly describe computer programs and how to create standards for such descriptions such that it will be easier to create compendia of available resources. In other words, despite the great success of the ARPANET, the basic resource sharing problem still

represents a fertile area for research and development. Now that the networking technology itself is "given", attempts at description and documentation of host resources might more easily yield to a research and development effort.

## 5. PROGRAM IMPACT AND ASSESSMENT OF TECHNOLOGY DEVELOPED

### 5.1 Service Use of Technology

The ARPANET technology is being successfully transferred to the rest of DoD. Not only was it possible to transfer the ARPANET itself to the Defense Communications Agency (Code 535),\* but the Defense Communications Agency has already embarked on the procurement of its primary backbone major communications system of the future -- AUTODIN II -- based very specifically on the packet switching technology developed in the ARPANET. Even beyond this very major step all three services are actively involved in investigations of packet switching technology for their specific needs.

### 5.2 Impact on Non-DoD Programs

In just the very short time since the inception of the ARPANET this technology has already resulted in the formation of a new industry: a private sector development of "value added" packet switching networks. Two corporations, Telenet and Tymshare, are currently marketing packet switched communications to the general public as common carriers under the Communications act of 1934. This program therefore has also had direct and immediate exploitation in the commercial sector. In addition,

-----  
\* Now DCA Code 252 (December 1981).

all over the world new communications systems are being designed and built to take advantage of the packet switching technology demonstrated by the ARPANET project. At least three countries -- Great Britain, France and Canada -- have major national PTT-sponsored packet switching networks either already operating or under development and many other countries are actively pursuing this technology.

### 5.3 Applications of the Program Results

The most specific result of the ARPANET Program has, of course, been the ARPANET itself; and the ARPANET itself is currently fully operational under the management of the Defense Communications Agency and is actively serving thousands of individuals on a daily basis.

### 5.4 Advance in the State-of-the-Art

The ARPANET program has represented a first-rank advance in the state-of-the-art of communications and the state-of-the-art of computer technology. The greatest advance has been in the provision of cost effective, reliable, high performance digital communications, but very significant state-of-the-art advances have also taken place in many other areas, such as topological optimization, routing, multiprocessor technology, protocols for resource sharing between programs, network mail systems, and remote computer management.

## 6. BIBLIOGRAPHY OF REPORTS

There has been an enormous amount of literature about the ARPANET in particular, and about resource sharing computer networks in general. Literally an industry has been formed in the space of two-thirds of a decade and the amount of literature reflects this really unusual metabolism.

The initial seminal papers on the ARPANET were presented in May of 1970 at the AFIPS Spring Joint Computer Conference in Atlantic City and are published in the Proceedings of that conference (AFIPS Conference Proceedings, Vol 36, AFIPS Press, 210 Summit Avenue, Montvale, New Jersey 07645). Another early ARPANET session was held at the 1972 Spring Joint Computer Conference in Atlantic City and these papers are published in AFIPS Conference Proceedings, Vol. 40. These two early sets of papers represent a sensible introduction to the early notions about and plans for the ARPANET.

A sizeable bibliography and index to publications about the ARPANET was published in 1976 with DARPA support: "Selected Bibliography and Index to Publications About the ARPANET", Becker and Hayes Inc., February 1976, 185 pages, AD-A026900. This document represents the most complete available listing about ARPANET publications, but it is a bibliography only and does not provide help in trying to select which of the many references



would be suitable to look at in what order. Another bibliography on the literature of resource sharing computer networks in general (not just the ARPANET) has been issued by the U.S. Department of Commerce, National Bureau of Standards: "Annotated Bibliography of the Literature on Resource Sharing Computer Networks", NBS Special Publication 384, revised 1976. This document is also not very useful in helping the reader decide what is important and what is not.

Several volumes of reprints have been published which deal with computer networks in general (rather than the ARPANET specifically), but which attempt to collect together the important papers themselves and provide a much easier entry to the literature than the large bibliographies: (1) "Advances in Computer Communications", Wesley W. Chu, Artech House, Inc., 610 Washington St., Dedham, Massachusetts 02026, 1974; (2) "Computer Communications", edited by Paul E. Green, Jr. and Robert W. Lucky, IEEE Press, 345 East 47th Street, New York, New York 10017, 1975; and (3) "Computer Networking", edited by Robert P. Blanc and Ira W. Cotton, IEEE Press, 345 East 47th Street, New York, New York 10017, 1976.

A very hefty, but fairly readable compendium with a very large list of references is "Infotech State of the Art Report 24, Network Systems and Software", Infotech International Ltd.,

Nicholson House, Maidenhead, Berkshire, England, 1975. This document deals with far more than just the ARPANET, but it tries to put the ARPANET in context with other current work as of 1975.

There are three important reference documents which have been prepared for the Defense Communications Agency by the Network Information Center at Stanford Research Institute, Menlo Park, California 94025 which are specifically addressed to various aspects of the ARPANET: (1) "ARPANET Resource Handbook", NIC 39335, December 1976; (2) "ARPANET Protocol Handbook", NIC 7104, Revision 1, April 1976; (3) "ARPANET Directory", NIC 36437, July 1976.

A textbook on computer networks is Davies and Barber, "Communication Networks for Computers", John Wiley, 1973. A special issue of the IEEE proceedings on Packet Communications was issued in November, 1978.

Report No. 4799

Bolt Beranek and Newman Inc.

CHAPTER III: A HISTORY OF THE ARPANET PROJECT

## 1. HISTORY

The DARPA Computer Network, or ARPANET as it has come to be called, consists of IMPs, lines, and hosts as shown in Figure 1. The IMPs (short for Interface Message Processors) are small, special-purpose computers connected to each other by telephone lines. The hosts are a heterogeneous collection of computers

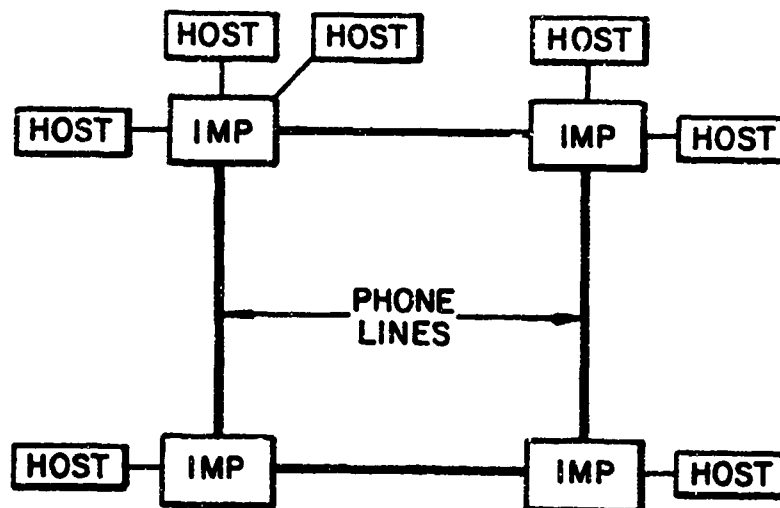

Figure 1 -- IMPs, Lines, and Hosts

used for a variety of applications. The IMPs provide a communications subnetwork through which hosts communicate with each other, much as the commercial telephone system provides a

communications subnetwork through which humans communicate. In other words, the IMPs and lines make up a communications utility of which the hosts are users. Each host is connected to one IMP; one IMP may have several hosts connected to it.

When data is to be sent from one host to another, the data is broken into discrete entities called "messages" at the sending host, which is also called the "source host". Each message consists of some data and an address. The address specifies to which host the data is to be sent, that is, the "destination host". Successive messages are passed from the source host to its IMP, where they are broken into smaller entities called "packets", each of which carries the same address as the message. The packets are routed from IMP to IMP across the network until they arrive at the IMP to which the destination host is connected, where the original messages are reconstructed from the packets, and passed to the destination host.

The ARPANET was conceived in the middle to late 1960s as a project to be sponsored by the Information Processing Techniques Office of the Defense Advanced Research Projects Agency (DARPA) of the U.S. Department of Defense (DoD). Construction of the network began in 1969. By 1975 the network had gone through several stages of development and for all intents and purposes had become an operational Department of Defense computer network.

In 1975, control of the network was transferred from DARPA to the U.S. Defense Communications Agency, an agency better suited to the administration of a working facility.

The ARPANET is a major development in the evolution of computer communications. Our purpose here is to present the history of the ARPANET: why it was built, who helped build it, the major design decisions (and some of the minor ones) associated with it, its evolutionary development, its maturity, and why it is important.

## 1.1 Background

### 1.1.1 The RAND Study of Distributed Communications Networks

One of the most important early studies of computer networks was performed by Paul Baran and his colleagues at the RAND Corporation in the early 1960s. Many concepts central to the later development of the ARPANET and other computer networks were first described in the series of reports published by RAND in 1964 (a list of these reports is given in the bibliography at the end of this subsection). These ideas include the improved reliability of a distributed network structure over a centralized or star network and over so-called decentralized networks made up of a collection of smaller star networks. Extensive studies were undertaken, including simulation of some grid networks, to determine how "survivable" a distributed network could be expected to be after heavy node and link failures. This study was particularly concerned with the question of keeping a high percentage of the network available and performing well in the face of enemy attacks on the network, from the point of view of its suitability for Department of Defense applications.

In specifying closely the engineering details of what was called the "Distributed Adaptive Message Block Network", Baran anticipated many of the developments in practical networks that came a full decade later. In the Distributed Adaptive Message

Block Network, a "multiplexing station" connects up to 1024 terminals of widely differing characteristics. Automatic user-to-user cryptography is integrated into the network switching technique to ensure efficiency. Both satellite links and low-cost microwave relay systems are suggested as techniques for providing the network with very high data rate circuits. The concept of a "message block" is introduced: a packet of up to 1024 bits of header and data, which is the unit of data transferred in the network. One of the most interesting aspects of this study is that it concluded that a large-scale digital transmission network was not only feasible but also highly cost-effective, and proposed that many of the switching functions be implemented in hardware. Baran was considering ways of making extremely reliable networks, and so preferred simple solutions and reliable hardware where possible.

The following bibliography includes the entire set of eleven reports in the original RAND study as well as two published papers resulting from that set and from two later reports. An annotated version of this bibliography is included in "Adaptive Routing Algorithms for Distributed Computer Networks" (John M. McQuillan, BBN Report No. 2831, May 1974, pp. 14-17).



## Bibliography

- P. Baran, "On Distributed Communications: I. Introduction to Distributed Communications Networks," RAND Corp. Memo RM-3420-PR, August 1964, 37p.
- S. Boehm and P. Baran, "On Distributed Communications: II. Digital Simulation of Hot-Potato Routing in a Broadband Distributed Communications Network," RAND Corp. Memo RM-3103-PR, August 1964, 49p.
- J. W. Smith, "On Distributed Communications: III. Determination of Path-Lengths in a Distributed Network," RAND Corp. Memo RM-3578-PR, August 1964, 91p.
- P. Baran, "On Distributed Communications: IV. Priority, Precedence, and Overload," RAND Corp. Memo RM-3638-PR. August 1964, 63p.
- P. Baran, "On Distributed Communications: V. History, Alternative Approaches, and Comparisons," RAND Corp. Memo RM-3097-PR August 1964, 51p.
- P. Baran, "On Distributed Communications: VI. Mini-Cost Microwave," RAND Corp. Memo RM-3762-PR, August 1964, 101p.
- P. Baran, "On Distributed Communications: VII. Tentative Engineering Specifications and Preliminary Design for a High-Data-Rate Distributed Network Switching Node," RAND Corp. Memo RM-3763-PR, August 1964, 85p.
- P. Baran, "On Distributed Communications: VIII. The Multiplexing Station," RAND Corp. Memo RM-3764-PR, August 1964, 103 p.
- P. Baran, "On Distributed Communications: IX. Security, Secrecy, and Tamper-Free Considerations," RAND Corp. Memo RM-3765-PR, August 1964, 39p.
- P. Baran, "On Distributed Communications: X. Cost Analysis," RAND Corp. Memo RM-3766-PR, August 1964, 21p.
- P. Baran, "On Distributed Communications: XI. Summary Overview," RAND Corp. Memo RM-3767-PR, August 1964, 23p.
- P. Baran, "On Distributed Communication Networks," IEEE Transactions on Communications Systems Vol. CS-12, March 1964, pp. 1-9.

Report No. 4799

Bolt Beranek and Newman Inc.

B. W. Boehm and R. L. Mobley, "Adaptive Routing Techniques for Distributed Communications Systems," RAND Corp. Memo RM-4781-PR, February 1966, 78p.

B. W. Boehm and R. L. Mobley, "A Computer Simulation of Adaptive Routing Techniques for Distributed Communications Systems," RAND Corp. Memo RM-4782-PR, February 1966, 35p.

B. W. Boehm and R. L. Mobley, "Adaptive Routing Techniques for Distributed Communications Systems," IEEE Transactions on Communication Technology, Vol. COM-17, No. 3, June 1969, pp. 340-349.

### 1.1.2 The Lincoln/SDC Experiment

The notion of linking computers into a network was envisioned by J.C.R. Licklider long before the ARPANET became a reality. Licklider was the first director of DARPA IPTO.

In 1965 Thomas Marill and his colleagues at Computer Corporation of America (in Cambridge, Massachusetts) were commissioned by M.I.T. Lincoln Laboratory to study the concept of computer networking. The primary technical contact at Lincoln Laboratory was Lawrence Roberts, who played an active role in the network study; and the contract was, in fact, a subcontract under the Laboratory's DARPA contract. The study was done in late 1965 and a report on the study was issued in 1966 ("A Cooperative Network of Time-Sharing Computers", Thomas Marill, Computer Corporation of America, Technical Report No. 11, June 1, 1966; a later paper of the same name authored by Thomas Marill and Lawrence Roberts also appeared in the Proceedings of the AFIPS 1966 Spring Joint Computer Conference, pp. 425-431). The report examined the basic idea of computer networking, considered the available communications techniques and software problems, and recommended that a three-computer experimental network be constructed. The report suggested linking three existing computers, the AN/FSQ-32 at Systems Development Corporation, the IBM 7094 at MIT's Project MAC, and Lincoln Laboratory's TX-2.

Later in 1966, CCA received another contract to carry out the linking of the Q-32 and the TX-2. The Q-32 and TX-2 were in fact linked together, and the link was demonstrated. Later a small Digital Equipment Corporation machine at DARPA was added to this network, by now known as "The Experimental Network". It is noteworthy that The Experimental Network linked host computers directly, and did not use IMPs.

### 1.1.3 The NPL Data Network

Another early major network development which affected development of the ARPANET was undertaken at the National Physical Laboratory in Middlesex, England, under the leadership of D. W. Davies. The broad system design of the NPL Data Network, as it was called, was first published in 1967, and bears a resemblance to the network proposed by Paul Baran at RAND, and to the ARPANET. The NPL Data Network was specified to be a packet-switching network and was to have a hierarchical structure. It was proposed that "local networks" be constructed with "interface computers" which had responsibility for multiplexing among a number of user systems and for communicating with a "high level network". The latter would be constructed with "switching nodes" connected together with megabit rate circuits.

Considerable detail about the NPL Data Network may be found in the textbook, written by two of the network's designers, -entitled Communications Networks for Computers (D.W. Davies and D.L.A. Barber, John Wiley & Sons, publishers, 1973). A bibliography of published papers resulting from the NPL Data Network effort follows.

## Bibliography

- D. W. Davies, K. A. Bartlett, R. A. Scantlebury, and P. T. Wilkinson, "A Digital Communication Network for Computers Giving Rapid Response at Remote Terminals," ACM Symposium on Operating Systems Problems, October 1967, 17p.
- K. A. Bartlett, R. A. Scantlebury, and P. T. Wilkinson, "A Data Communication Network for Real-Time Computers," IEEE International Conference on Communications, U.S.A., June 1968.
- D. W. Davies, "Communication Networks to Serve Rapid Response Computers," Proceedings of the IFIP Congress 1968, Vol. 2 - Hardware Applications, pp. 650-658.
- K. A. Bartlett, "Transmission Control in a Local Data Network," Proceedings of the IFIP Congress 1968, Vol. 2 - Hardware Applications, pp. 704-708.
- D. W. Davies, "The Principles of a Data Communications Network for Computers and Remote Peripherals," Proceedings of the IFIP Congress 1968, Vol. 2 - Hardware Applications, pp. 709-715.
- R. A. Scantlebury, P. T. Wilkinson, and K. A. Bartlett, "The Design of a Message Switching Centre for a Digital Communication Network," Proceedings of the IFIP Congress 1968, Vol. 2 - Hardware Applications, pp. 723-733.
- P. T. Wilkinson and R. A. Scantlebury, "The Control Functions in a Local Data Network," Proceedings of the IFIP Congress 1968, Vol. 2 - Hardware Applications, pp. 734-738.
- D. W. Davies, "A Versatile Data Communication Network," Colloque International sur la Teleinformatique, Paris, March 1969, pp. 461-467.
- D. L. A. Barber, D. V. Blake, and R. A. Scantlebury, "Implementation of the British Standard Interface for Data Exchange between Sources and Acceptors of Digital Data," Colloque International sur la Teleinformatique, Paris, March 1969, pp. 807-816.
- K. A. Bartlett, R. A. Scantlebury, and P. T. Wilkinson, "A Note on Reliable Full-Duplex Transmission over Half-Duplex Lines," CACM, Vol. 12, No. 5, May 1969, p. 260.
- D. L. A. Barber, "Experience with the Use of the British Standard Interface in Computer Peripherals and Communication Systems," ACM Symposium on Data Communication, Pine Mountain, October 1969.

R. A. Scantlebury, "A Model for the Local Area of a Data Communication Network - Objectives and Hardware Organization," ACM Symposium on Data Communication, Pine Mountain, October 1969.

P. T. Wilkinson, "A Model for the Local Area of a Data Communication Network - Software Organization," ACM Symposium on Data Communication, Pine Mountain, October 1969.

D. L. A. Barber and D. W. Davies, "The NPL Data Network," Proceedings of the Conference on Laboratory Automation, Novosibirsk, October 1970.

D. W. Davies, "The Control of Congestion in Packet Switching Networks," Proceedings of the Second ACM/IEEE Symposium on Problems in the Optimization of Data Communication Systems, October 1971, pp. 46-49; also in Transactions of IEEE, Vol. COM-20, No. 3, June 1972.

R. A. Scantlebury and P. T. Wilkinson, "The Design of a Switching System to Allow Remote Access to Computer Services by Other Computers and Terminal Devices," Proceedings of the Second ACM/IEEE Symposium on Problems in the Optimization of Data Communication Systems, October 1971, pp. 160-167; also in Transactions of IEEE, Vol. COM-20, No. 3, June 1972.

W. L. Price, "Simulation of Packet-Switching Networks Controlled on Isarithmic Principles," ACM Third Data Communications Symposium, Florida, November 1973. pp. 44-49.

R. A. Scantlebury and P. T. Wilkinson, "The National Physical Laboratory Data Communication Network," Proceedings of the ICC Conference, Stockholm, August 1974, pp. 229-238.

D. W. Davies, "Packet Switching, Message Switching and Future Data Communication Networks," IFIP Congress, Stockholm, August 1974, pp. 147-150.

W. L. Price, "Simulation Studies of an Isarithmically Controlled Store and Forward Data Communication Network, Proceedings of the IFIP Congress, Stockholm, August 1974, pp. 151-154.

## 1.2 The Events of 1967 and 1968

The years 1967 and 1968 were spent promoting interest in the ARPANET project both within the government and with IPTO contractors, deciding the fundamental structure of the network, writing a request for quotation, selecting a contractor, and other related activities.

In early 1967, work began on the conventions to be used for exchanging messages between any pair of computers in the proposed network, and also on consideration of the kinds of communications lines and data sets to be used. In particular, it was decided that the inter-host communication "protocol" would include conventions for character and block transmission, error checking and retransmission, and computer and user identification. Frank Westervelt, then of the University of Michigan, wrote a position paper on these areas of communication, an ad hoc "Communication Group" was selected from among the institutions represented, and a meeting of the group scheduled.

The plan considered throughout much of the Michigan meeting was to connect all of the computers by dial-up telephone lines and data sets so as to allow any computer to establish communication with any other computer using a line-switching technique (i.e., calling it up on the telephone). A small program in each computer would interface to the data set and



phone line and when given a message to another computer, the small interface program would perform a "message-switching" and transmission function, deciding how to actually reach the other computer and transmitting the message to it. Wes Clark, then of Washington University, is credited with proposing at some point in the meeting that a small computer be inserted between each participant's computer and the phone line. This concept was further refined within DARPA, and the concept of the Interface Message Processor or IMP emerged.

The IMP would perform the functions of dial-up, error checking, retransmission, routing, and verifications on behalf of the participants' computers (which we shall hereafter call hosts). Thus the IMPs plus the telephone lines and data sets would constitute a "message-switching network". The protocols which were to be established would define the communications formats between the IMPs. The interface between a host and an IMP would be a digital interface of a much simpler sort requiring no host consideration of error checking, retransmission, and routing. It was clearly noted that the major disadvantage of inserting the IMP was the cost of installation of another computer beside each host. The major advantage of inserting the IMPs was recognized to be the fact that a unified, straightforward network design could be made and implemented without undue consideration of the variations and constraints of

the host computers. Further, as the network evolved, it would be much simpler to modify the network of IMPs than to modify all the host computers. Finally, the IMPs would relieve the hosts of the communications burdens they were initially scheduled to carry. It was also noticed that if necessary IMPs could be located at strategic connection points within the network to concentrate messages over cross-country phone lines. a network of IMPs was likely to be implemented faster than a network of directly connected hosts, and the network of IMPs provided a distinct network entity which would be useful in presenting the network publicly.

By October 1967 the proposed network was becoming known as the ARPA Computer Network, or ARPANET for short. A variety of topics were under discussion at that time including message formatting, message protocols, dynamic routing and message propagation, queuing, error control, measurements, and IMP-to-host communication. It was decided that 50 Kb communications lines would be used because of the vastly improved response time which could be obtained with these lines as opposed to the previously proposed 2.4 Kb lines. The 50 Kb lines were to be leased, eliminating the slow dial-up procedure. The nature of the telephone tariffs available to the government made use of 50 Kb. lines affordable. With each IMP normally permanently connected to at least two other IMPs via the leased 50 Kb lines.

the IMPs were to use store-and-forward techniques to provide fast message handling. Each IMP was to accept messages of up to 8,000 bits from its host computer and to break this into 1,000-bit packets. Each packet was to be treated independently and routed on one of the two or more inter-IMP lines. When a packet arrived at an IMP, it was to be stored, error checked, and routed on to a further IMP. At its destination, packets would be held until an entire message could be assembled and then delivered to the destination host. With an average of say three lines per IMP, it was expected that approximately three store-and-forward stages would be necessary to get a message from any one of twenty locations to any other.

In July 1968, an RFQ for the network was mailed out to prospective bidders. Twelve proposals were received by the Agent (DSSW). Four bidders were rated within the zone of contention to receive the IMP contract, and supplementary technical briefings were requested from each of these bidders. Final negotiations were carried out with two finalists, and one was chosen in the week before Christmas, 1968. The contract was awarded and work began the second day of the New Year in 1969.

### 1.3 Key Aspects of the RFQ

It was specified that responses to the RFQ would be evaluated on four criteria in addition to cost:

1. Understanding and depth of analysis of technical problems involved.
2. Availability of qualified, experienced personnel for assignment to software, hardware, and installation of the system.
3. Estimated functional performance and choice of hardware.
4. General quality, responsiveness, and corporate commitment to the network concept.

The RFQ had provision for a bidders conference and stated that there would be no other opportunity for bidders to discuss technical issues with the government. Bidders were asked to provide a system design for a nineteen-IMP network, but to price a four-IMP network. A thirteen-month performance period was requested to include design, construction of a prototype IMP, and implementation and installation of four operational IMPs. The four IMPs were to be installed nine months after start of the contract with the contractor supporting them in the field for three months after installation. The contractor was required to take full system responsibility, although subcontracting a portion of the work was a possibility.

- I. Network Description
  - A. Introduction
  - B. Functional Description
    - 1. The User Subnet
    - 2. The Communication Subnet
  - C. Functional Description of the IMPS
    - 1. Breaking of Messages into Packets
    - 2. Management of Message Buffers
    - 3. Routing of Messages
    - 4. Generation, Analysis and Alteration of Formatted Messages
    - 5. Coordination of Activities with Other IMPS
    - 6. Coordination of Activities with its HOST(s)
    - 7. Measurement of Network Parameters and Functions
    - 8. Detection and Disposition of Faults
    - 9. IMP Software Separation Protection
  - D. The HOST-IMP Interfaces
  - E. The IMP-CARRIER Interfaces
  - F. Network Performance Characteristics
    - 1. Message Delay
    - 2. Reliability
    - 3. Network Capacity
    - 4. Network Model
  - G. HOST-HOST Characteristics
  - H. IMP-Operator Interface
- II. Network Contractor Performance
- III. Elements of System Design
- Appendix
  - A. ARPA Network Nodes
  - B. ARPA Network Topology
  - C. IMP Delivery Schedule
  - D. Input and Output Facilities for the IMP Operator
  - E. ARPA Network Data Rates Between Nodes in Kilobits/sec.
  - F. Data Communications Conventions
  - G. Routing

Figure 2: Table of Contents from RFQ Statement of Work

The IMP specification clearly delineated the division of responsibilities among host sites, IMP contractor, and telephone company. Each individual host site was responsible for designing and implementing for its own convenience the hardware and software necessary to attach the host to the network, and the hardware and software to utilize other hosts on the network. The telephone company was to be responsible for providing necessary circuits, data sets, and line conditioning equipment utilized by the network. The IMP contractor was to be responsible for providing necessary hardware and software to connect IMPs to each other using the circuits supplied by the telephone company and to connect IMPs to hosts, as well as providing hardware and software necessary to implement the procedures which allowed creation of a network of IMPs capable of forwarding messages from one host to another.

The functional description of an IMP specified the use of messages not longer than 8192 bits which would be broken into packets of not more than 1024 bits. Messages were limited in size to make them manageable for the hosts. Shorter packets were used to reduce the probability of transmission error with the attendant necessity for retransmission. It was noted that IMP provision of message and packet buffer space would permit speed conversions to take place, provide queuing space in the face of delays, and permit retransmission in the event of erroneous

transmission. A routing algorithm was hypothesized which would take into account the connectivity of the network, IMP and line busyness, and message priority, and use this information to forward a packet to the next IMP on a path to the ultimate destination; periodic updates based on exchange of routing and loading information with other IMPs and hosts was also hypothesized. An IMP was to coordinate its activities with other IMPs and its hosts and perhaps other special hosts. IMPs were to take messages from a local host at the IMP's convenience, but to send messages to a local host at the host's convenience. The IMPs were to be able at selected times to measure selected network parameters and to trace the movements of selected messages through the network. The data resulting from these measurements and tracings was to be capable of transmission to a host, and the measurement activity was to be capable of initiation and termination by a host or another IMP. The IMPs were to detect and recover from various IMP, host, and line failures. In particular, it was to be possible to stop, start, examine, or reload IMPs from selected network hosts. Finally, it was thought that at each IMP site, it would be possible for special host-specific code to be provided by host site programmers, and thus it was desirable to protect the rest of the IMP from the portion that the host personnel could access and program.

There were two particularly interesting aspects of the host-to-IMP interface: 1) a standard host interface was to be specified rather than a different one for each host; 2) each bidder was to consider the cost of providing interfaces to multiple hosts per IMP, although only one host interface was required; and 3) sufficient program space was to be left to do host-specific character code conversion and repacking of binary messages.

The interface between an IMP and its telephone lines was required to have hardware to sense characters, detect control characters, calculate and check the 24-bit CRC, provide a real-time clock with 20 microseconds resolution, and provide fault and status information. Further, the IMP was to be optimized to handle three lines but be capable of handling six.

Several network performance characteristics were specified. The average message delay for a short message to go from a source IMP to a destination IMP was to be less than one-half second for a fully loaded network. The probability of lost messages and message errors was to be very low. Interestingly, network capacity was considered third in order of importance and was defined to be the maximum bit rate that can be input at every node and still have the message delay remain less than one-half second; a 20 Kb network capacity was hoped for. A network model was presented.



Host-to-host traffic flows were estimated and it was hypothesized that there would be a trimodal distribution of traffic type (high rate and short length, medium rate and medium length, and low rate and long length).

In addition to considering the option of multiple hosts connected to an IMP, the bidder was also asked to consider the provision of memory protection to facilitate simultaneous IMP operation and checkout of new software, and to consider what additional hardware and software would be necessary for an IMP to provide a terminal concentration capability for its host or for the network (i.e., no host, just terminals).

#### 1.4 Chronological Development, 1969 to 1975

Within a year after the award of the IMP contract, the first IMPs were installed in the field. Hosts were connected to these first IMPs and a series of network measurements was undertaken. Host software was written, hosts began to communicate with each other, more IMPs and hosts were added, and gradually the ARPANET became an operating entity. After six years of development and operation the network was no longer best suited to management by an agency with the charter to sponsor advanced research and development, and thus network management was transferred to the Defense Communications Agency. In the following subsections we describe the happenings of the years 1969 to 1975.

#### 1.4.1 The Groups and the Key People

The ARPANET development was a joint effort of many individuals and institutions, all responsive to DARPA's direction. Before we describe the ARPANET development further, it is best to list the principal "players" and briefly describe their areas of responsibility.

## 1.4.1.1 Management and Administration of the Network:

DARPA IPTO, DSS-W, RML, and DECCO

Naturally, DARPA IPTO played a major role in the development of the network. The director of IPTO at the time was Robert Taylor, who provided the necessary support as well as encouragement in helping to fund the network. Lawrence Roberts was the initial program manager for the network program. Roberts promoted the network, made certain key architectural decisions, led the evaluation team which selected the IMP contractor and selected other involved contractors. He also succeeded Taylor as director of IPTO.

While IPTO set policy for the network, made decisions about who would join the network, etc., IPTO did not run the network day by day. BBN provided day-by-day operation and maintenance of the network, and BBN and the other contractors involved carried out much of the day-by-day business of the network among themselves without need for daily IPTO supervision.

Initially IPTO itself took care of ordering telephone lines, filling out forms which were sent to DECCO for procurement from and execution by the various telephone companies. Also, IPTO initially did its own technical monitoring of the various contractors associated with the ARPANET; DSS-W was used as the procurement agency for the contractors. Eventually, attempting

to rid itself of the routine, tedious aspects of ordering communications lines and providing technical monitoring of contractors, IPTO shifted the DSS-W functions, routine dealings with DECCO, and some contractor technical monitoring to the Range Measurements Laboratory at Patrick Air Force Base in Florida; in addition to having a procurement capability, RML also had a technical support capability.

There were several other members of the IPTO staff who have been prominent in the management of the ARPANET besides Roberts. These have included A. Blue, B. Wessler, D. Carlstrom, S. Crocker, B. Dolan, C. Fields, S. Walker, and D. Russell.

As mentioned above, IPTO often played a strong technical role in the ARPANET, and members of the IPTO staff wrote a number of papers describing the ARPANET activity. Several of these papers are listed in the following bibliography.

Bibliography

- T. Marill and L. G. Roberts. "Toward a Cooperative Network of Time-Shared Computers," Proceedings FJCC 1966, p.425-431.
- L. G. Roberts, "Multiple Computer Networks and Intercomputer Communication," ACM Symposium on Operating System Principles, October 1967, 7p.
- L. G. Roberts and B. D. Wessler. "Computer Network Development to Achieve Resource Sharing," Proceedings SJCC 1970, p.543-549.
- L. G. Roberts, "A Forward Look," Signal, August 1971, p.77-81.
- L. G. Roberts, "ARPA Network Implications," EDUCOM Bulletin, Fall 1971, p.4-8.
- L. G. Roberts, "ARPANET: Current Status, Future Plans," EDUCOM Spring Conference, April 1972, p.7-12.
- L. G. Roberts, "Network Rationale: A 5-Year Reevaluation," Proceedings COMPCON 1973, February 1973, p.3-6.
- L. G. Roberts, "Dynamic Allocation of Satellite Capacity through Packet Reservation," Proceedings NCC&E 1973, p.711-716.
- L. G. Roberts, "The ARPA Net," in Computer-Communication Networks, N. Abramson and F. Kuo (Eds.), Prentice-Hall, 1973.
- S.D. Crocker, J.B. Postel, J.F. Heafner, R.M. Metcalfe. "Function-oriented Protocols for the ARPA Computer Network," AFIPS Conference Proceedings 40, May, 1972, pp. 271-279.

#### 1.4.1.2 The Network Analysis Corporation

Led by Dr. Howard Frank, the Network Analysis Corporation (NAC) of Glen Cove, Long Island, was put under contract by DARPA to specify the topological design of the ARPANET and to analyze its cost, performance, and reliability characteristics.

In the process of evaluating any of the parameters of a particular network design, such as cost, reliability, delay, or throughput, it is necessary to simulate the flow of traffic through the proposed network. Then, the design may be altered slightly to improve one of these measures. In this procedure, it is important to have a facility for specifying the routes on which traffic will flow in the network, and the procedure must not be too complex since it must be repeated so often in the iterative design process. NAC has developed some very efficient methods for incremental changes to a shortest-path routing algorithm as the network topology is changed. Further, they have discovered a faster shortest-path algorithm than was previously available, taking advantage of the low connectivities usually present in most practical communications networks.

The following bibliography lists much of the published work by NAC related to the ARPANET.

## Bibliography

NAC First Semiannual Technical Report for the Project, "Analysis and Optimization of Store-and-Forward Computer Networks," June 1970, 62p.

NAC Second Semiannual Technical Report for the Project, "Analysis and Optimization of Store-and-Forward Computer Networks," January 1971, 96p.

NAC Third Semiannual Technical Report for the Project, "Analysis and Optimization of Store-and-Forward Computer Networks," June 1971, 109p.

NAC Fourth Semiannual Technical Report for the Project, "Analysis and Optimization of Store-and-Forward Computer Networks," December 1971, 123p.

NAC Fifth Semiannual Technical Report for the Project, "Analysis and Optimization of Store-and-Forward Computer Networks," June 1972, 92p.

NAC Final Technical Report for the Project, "Analysis and Optimization of Store-and-Forward Computer Networks," October 1972, 120p.

H. Frank, I. T. Frisch, and W. Chou, "Topological Considerations in the Design of the ARPA Computer Network," Proceedings SJCC 1970, p.581-585.

H. Frank, I. T. Frisch, R. Van Slyke, and W. S. Chou, "Optimal Design of Centralized Computer Networks," Networks, Vol. 1, no. 1, 1971, p.43-58.

H. Frank and W. Chou, "Routing in Computer Networks," Networks, Vol. 1, No. 2, 1971, p.99-112.

H. Frank, "Computer Network Design," IEEE International Convention Record, March 1971, p.220-221.

H. Frank and W. Chou, "Throughput in Computer- Communications Networks," International State of the Art Report no. 6; Computer Networks, Infotech Information Ltd. Maidenhead, Berkshire, England, 1971, p.493-512.

R. Van Slyke and H. Frank, "Network Reliability Analysis: Part I," Networks, Vol. 1, No. 3, 1971, p.279-290.



R. Van Slyke and H. Frank, "Reliability of Computer-Communication Networks," Proceedings of the 1971 Winter ACM Simulation Conference, December 1971, p.71-82.

H. Frank and I. T. Frisch, "The Design of Large-Scale Networks," Proceedings of the IEEE, Vol. 60, No. 1, January 1972, p.6-11.

H. Frank, R. E. Kahn, and L. Kleinrock, "Computer Communication Network Design - Experience with Theory and Practice," Proceedings SJCC 1972, p.255-270; also in Networks, Vol. 2, No. 2, 1972, p135-166.

W. Chou and H. Frank, "Routing Strategies for Computer Network Design," Proceedings of the Microwave Research Institute International Symposium on Computer-Communications Networks and Teletraffic, April 1972, p.301-309.

A. Kershenbaum and R. Van Slyke, "Computing Minimum Spanning Trees Efficiently," Proceedings of the ACM Annual Conference, August 1972, p.518-527.

H. Frank and W. Chou, "Topological Optimization of Computer Networks," Proceedings of the IEEE, Vol. 60, No. 11, November 1972, p.1385-1397.

H. Frank, "Optimal Design of Computer Networks," in Computer Networks, R. Rustin (Ed.), Prentice-Hall, 1972, p.167-183.

M. Gerla, "Deterministic and Adaptive Routing Policies in Packet-Switched Computer Networks," ACM Third Data Communications Symposium, Florida, November 1973, p.23-28.

W. Chou, H. Frank, R. Van Slyke, "Simulation of Centralized Computer Communications Systems," ACM Third Data Communications Symposium, Florida, November 1973, p.121-130.

W. Chou and A. Kershenbaum, "A Unified Algorithm for Designing Multidrop Teleprocessing Networks," ACM Third Data Communications Symposium, Florida, November 1973, p.148-156.

H. Frank, "Providing Reliable Networks with Unreliable Components," ACM Third Data Communications Symposium, Florida, November 1973, p.161-164.

I. Gitman, R. M. Van Slyke, and H. Frank, "On Splitting Random Accessed Broadcast Communication Channels," Proceedings of the Seventh Hawaii International Conference on System Sciences, January 1974, 5p.

#### 1.4.1.3 The Telephone Companies

Building a nationwide communications network means doing business with a number of telephone companies; further, if the network is to have overseas or foreign components, one must also deal with various international carriers and national Post Telephone Telegraphs. This task was handled by DECCO, which negotiated with the relevant telephone companies and obtained the specified service at the best price. In the case of a circuit from UCLA to RAND, for example, most likely the service would be procured from General Telephone, the dominant telephone company in the Los Angeles area.

In the example just given, a requested circuit fell completely within the jurisdiction of a single telephone company. To handle all instances when the requested service spanned the jurisdictions of more than one telephone company, the Bell System utilized their Long Lines division; and in the case of many of the ARPANET circuits, the company from which DECCO procured the service was Long Lines, which in turn procured the components necessary to make up the requested service from the regional telephone companies.

For the first several years of the ARPANET development, the Long Lines customer representatives to DARPA were, in turn, Al Fraser, Bill Gordon, and Ken Stanley. A customer

representative's job is to make the customer aware of the kinds of service available and to keep him happy with the service he receives. Fortunately for the ARPANET, the Bell System understood that a customer building a nationwide network needed the assistance of some central individual with a broad grasp of the requirements rather than having to rely on the usual miscellaneous dealings with local telephone companies. Thus the Long Lines representative, who from his position in Long Lines was already in contact with his counterparts in the many regional telephone companies, was permitted to use his network of contacts to provide informal coordination of the entire Bell System service to the ARPANET.

For instance, installing a telephone circuit between two IMPs requires that the IMPs and the telephone companies at both ends all be ready simultaneously. It is useless for the IMP supplier and one of the telephone companies to strain to make a scheduled date if the other telephone company cannot make that date. Similarly, it is useless for the telephone companies to strain to make a date if the IMP supplier cannot. The Bell System customer representative took it upon himself to coordinate all such interdependent events. By virtue of the Bell System's willingness to provide this critical coordination, an extremely smooth and efficient relationship has been built up between the IMP suppliers, DARPA, and the member companies of the Bell

System. For a network of the size and complexity of the ARPANET, there has been surprisingly little trouble with the procurement and operation of the telephone circuits.

## 1.4.1.4 Bolt Beranek and Newman Inc.

The contract to construct the IMP for the ARPANET was awarded to Bolt Beranek and Newman Inc. (BBN) of Cambridge, Massachusetts, where it was carried out in a group under the leadership of Mr. Frank Heart. Once the first IMPs were installed, BBN continued to play a central role in the evolution of the network, operating it and maintaining it as well as doing the development necessary for several major enhancements of its capability.

In addition to Frank Heart, a number of other individuals at BBN have been involved with the development of the ARPANET. The names of many of these individuals may be found as authors of the papers on the ARPANET which have come out of BBN. However, one individual, Robert Kahn, deserves particular mention. After several years as a principal member of the group working on the network at BBN, he moved to the IPTO office at DARPA from which he has probably done more to promote and support the continued advance of packet-switching technology than any other individual.

A bibliography of ARPANET-related reports and papers written by members of the BBN staff is included as Appendix A.

#### 1.4.1.5 The Network Information Center

The accessibility of distributed resources carries with it the need for an information service (either centralized or distributed) that enables users to learn about those resources. A contract was awarded to the Stanford Research Institute to develop and operate a "Network Information Center" (NIC) to be established for the ARPANET. With the beginning of implementation of the network in 1969, construction also began on the NIC at SRI.

The NIC provided several services. It maintained a list of network participants and distribution lists for various special interest groups within the network community. An archive of various document series was maintained. Documents could be sent to the NIC with instructions for duplication and distribution to the membership or one or more of the special interest groups. A highly structured data base construction, manipulation, and display system (called NLS) was made available on-line for use over the network. A list was kept of the resources available on hosts throughout the network. The various ARPANET protocol specifications were maintained on-line at the NIC.

The NIC has had a hand in the production or distribution of hundreds and hundreds of documents related to the ARPANET. A few of these documents describe the activities of the NIC itself or

Report No. 4799

Bolt Beranek and Newman Inc.

are otherwise of special interest within the ARPANET; a bibliography of these follows.

Bibliography

D. C. Engelbart, "Network Information Center and Computer Augmented Team Interaction", Stanford Research Institute, Augmentation Research Center, January 30, 1971, 105p.

D. C. Engelbart, "On-line Team Environment", Stanford Research Institute, Augmentation Research Center, June 2, 1972, 272p.

D. C. Engelbart, "Coordinated Information Service for a Discipline or Mission-oriented Community", Time-sharing: Past, Present, and Future, Second Annual Computer Communications Conference, 1973, pp. 2.1-2.4.

Current Catalog of the NIC Collection, NIC No. 5145.

Current Directory of Network Participants, NIC No. 5150.

Network Resource Handbook, NIC No. 6740.

Current Network Protocols, NIC No. 7104.



## 1.4.1.6 The Network Measurement Center

One of the influential early studies of communications networks was performed by Leonard Kleinrock and is reported in his 1962 Ph.D. thesis at MIT, Communication Nets: Stochastic Message Flow and Delay (reprinted by Dover Publications, New York, 1964). This study proved convincingly that message delays in a large store-and-forward network can be made very low, and thus put to rest one of the early and persistent objections to networking. Kleinrock considered several aspects of the operation of communications networks and their underlying algorithms in developing a precise model for networks. Kleinrock is today a faculty member at UCLA.

UCLA was selected to be the site of the first IMP installation, to allow early connection of an SDS SIGMA 7 host which was to be used to support the tasks of a Network Measurement Center (NMC). The NMC had the responsibility for much of the analysis and simulation of the ARPANET performance, as well as direct measurements based on statistics gathered by the IMP program. While Kleinrock himself was the guiding force at the NMC, over the years he had a series of students or staff members who supervised the day-to-day measurement work, including Gerald Cole, Vinton Cerf, Holger Opderbeck, and William Naylor (each obtained a UCLA Ph.D., although not necessarily for their NMC work).

· There has been a series of doctoral dissertations written by students at the UCLA School of Engineering and related to the work of the NMC. A list of of these theses. as well as other relevant publications by the faculty and students associated with the NMC, is included in the following bibliography.

## Bibliography

- L. Kleinrock, "Communication Nets: Stochastic Message Flow and Delay," Dover Publications, New York, 1964, 209p.
- L. Kleinrock, "Models for Computer Networks," Proceedings of the International Communications Conference, June 1969, p.21.9-21.16.
- L. Kleinrock, "Comparison of Solution Methods for Computer Network Models," Proceedings of the Computers and Communications Conference, October 1969.
- L. Kleinrock, "Analytic and Simulation Methods in Computer Network Design," Proceedings SJCC 1970, p.569-579.
- L. Kleinrock and G. L. Fultz, "Adaptive Routing Techniques for Store-and-Forward Computer Communication Networks," International State of the Art Report No. 6; Computer Networks, Infotech Information Ltd. Maidenhead, Berkshire, England, 1971, p.541-562; also in Proceedings of the International Conference on Communications, Montreal, Quebec, Canada, June 1971, p.39.1-39.8.
- G. Cole, "Performance Measurements on the ARPA Computer Network," Proceedings of the Second ACM/IEEE Symposium on Problems in the Optimization of Data Communications Systems, October 1971, p.39-45; also in IEEE Trans. on Communications, Vol COM-20, No 3, June 1972, p630-636.
- V. G. Cerf and W. E. Naylor, "Storage Considerations in Store-and-Forward Message Switching," Paper presented at WESCON Conference, September, 1972, 8p.
- V. G. Cerf and W. E. Naylor, "Selected ARPA Network Measurement Experiments," Proceedings COMPCON 1972, September 1972.
- L. Kleinrock, "Computer Networks," in Computer Science. A. F. Cardenas et al. (Eds.), John Wiley and Sons, Inc. New York, 1972, p.241-284.
- L. Kleinrock, "Performance Models and Measurement of the ARPA Computer Network," Proceedings of the International Symposium on the Design and Application of Interactive Computer Systems. Brunel University, Uxbridge, England, May 1972, 30p.
- L. Kleinrock, "Survey of Analytical Methods in Queueing Networks," in Computer Networks, R. Rustin (Ed.), Prentice-Hall, 1972, p.183-205.

D. Cantor and M. Gerla, "The Optimal Routing of Messages in a Computer Network Via Mathematical Programming," Proceedings COMPCON 72, September 1972, p.167-170.

L. Fratta, M. Gerla, and L. Kleinrock, "The Flow Deviation Method: An Approach to Store-and-Forward Communication Network Design," Networks, Vol. 3, No. 2, 1973. p.97-134.

D. G. Cantor and M. Gerla, "Capacity Allocation in Distributed Computer Networks," Proceedings of the Seventh Hawaii International Conference on System Sciences, January 1974, p. 115-117.

G. Cole, "Computer Networks Measurements: Techniques and Experiments," PhD Thesis, UCLA-ENG-7165, Computer Science Department, School of Engineering and Applied Science. UCLA, October 1971, 350p.

G. L. Fultz, "Adaptive Routing Techniques for Message Switching Computer-Communications Networks," PhD Thesis, UCLA-ENG-7252, Computer Science Department, School of Engineering and Applied Science, UCLA, July 1972, 418p.

M. Gerla, "The Design of Store-and-Forward (S/F) Networks for Computer Communications," PhD Thesis, UCLA-ENG-7319, Computer Science Department, School of Engineering and Applied Science. UCLA, January 1973, 300p.

Kleinrock, L. Queueing Systems, Volume I: Theory, Wiley Interscience, New York, 1975.

Kleinrock, L. Queueing Systems, Volume II: Computer Applications, Wiley Interscience, New York, 1976.

Kleinrock, L., "Scheduling, Queueing and Delays in Time-Shared Systems and Computer Networks," in Computer-Communication Networks, Abramson, N. and Kuo, F. (eds.), Prentice Hall, Englewood Cliffs, New Jersey, 1973. pp. 95-141.

Kamoun, F., "Design Considerations for Large Computer Communication Networks," PhD Thesis, UCLA-ENG-7642, Computer Science Department, School of Engineering and Applied Science. UCLA, April 1976, 407p.

Ziegler, J. and L. Kleinrock, "Nodal Blocking in Large Networks," ICC Conference Record, Montreal, Canada, June 1971, pp. 39-9 to 39-15.

Frank, H., R. Kahn and L. Kleinrock, "Computer Communication Network Design--Experience with Theory and Practice," AFIPS Conference Proceedings, Vol. 40, SJCC, Atlantic City, New Jersey, May 1972, pp. 255-270. Also in Networks, Vol. 2, No. 2 1972, pp. 135-166.

Kleinrock, L., "Analytical Techniques for Computer- Communication Networks," Computers and Communications, Proc. of the joint IBM-University of Newcastle upon Tyne Seminar, University of Newcastle upon Tyne, England, September 1973, pp. 63-90.

Kleinrock, L. and W. Naylor, "On Measured Behavior of the ARPA Network," AFIPS Conference Proceedings, Vol. 43, NCC, Chicago, May 1974, pp. 767-780.

Kleinrock, L. "Resource Allocation in Computer Systems and Computer Communication Networks," Proc. of the International Federation for Information Processing, Stockholm, Sweden, August 1974, pp. 11-18.

Opderbeck, H. and L. Kleinrock, "The Influence of Control Procedures on the Performance of Packet-Switched Networks," National Telecommunications Conference Record, San Diego, California, December 1974, pp. 810-817.

Naylor, W. E., "A Loop-Free Adaptive Routing Algorithm for Packet Switched Networks," Proc. of the 4th Data Communications Symposium, Quebec City, Canada, October 1975 pp. 7.9 to 7.14.

Kleinrock, L., W. Naylor and H. Opderbeck, "A Study of Line Overhead in the ARPANET," Proc. of the IIASA Conf. on Computer Communication Networks, October 1974, pp. 87-109. Also in Communications of the ACM, Vol. 19, January 1976, pp. 3-12.

Kleinrock, L. and H. Opderbeck, "Throughput in the ARPANET-- Protocols and Measurement," 4th Data Communications Symposium, Quebec City, Canada, October 1975, pp. 6-1 to 6-11. also in IEEE Trans. on Communications, Vol. COM-25, January 1977, pp. 95-104.

Kamoun, F. and L. Kleinrock, "Analysis of Shared Storage in a Computer Network Environment," Proc. of the 8th Hawaii International Conf. on System Science, Honolulu, January 1976, pp. 89-92.

Kleinrock, L. "ARPANET Lessons," Proc. of the ICC, Philadelphia, June 1976, pp. 20-1 to 20-6.

Kleinrock, L. and F. Kamoun. "Data Communications Through Large Packet-Switching Networks," Proc. of International Teletraffic Congress, Sydney, Australia. November 1976, pp. 521-1 to 521-10.

Naylor, W. and L. Kleinrock, "On the Effect of Periodic Routing Updates in Packet-Switched Networks," Proc. of the NTC, Dallas, Texas, November 1976, pp. 16.2-1 to 16.2-7.

Kleinrock, L., "On Communications and Networks," IEEE Trans. on Computers, 25th Anniversary Issue, Vol. C-25, December 1976, pp. 1326-1335.

Gerla, M. and L. Kleinrock, "On The Topological Design of Distributed Computer Networks," IEEE Trans. on Communications, Vol. COM-25, January 1977, pp. 48-60.

Kleinrock, L. and F. Kamoun, "Hierarchical Routing for Large Networks, Performance Evaluation and Optimization." Computer Networks, Vol. 1, No. 3, January 1977, pp. 155-174.

Kleinrock, L., "Performance of Distributed Multi-Access Computer-Communication Systems," Proc. of IFIP Congress, Toronto, Canada, August 1977, pp. 547-552.

Kermani, P. and L. Kleinrock, "Analysis of Buffer Allocation Schemes in a Multiplexing Node," ICC Conference Record, Vol. 2, Chicago, Illinois, June 1977, pp. 30.4-269 to 30.4-275.

#### 1.4.1.7 The Network Working Group and Host Involvement

The initial design of the ARPANET as contained in the RFQ went some way toward specifying certain formats for inter-IMP communications and for AP-to-host communication. Less explicit attention was given to host-to-host communication, this area being left for host sites to work out among themselves.

To provide the hosts with a little impetus to work on the host-to-host problems, DARPA assigned the problem to Elmer Shapiro of SRI. After an initial meeting, S. Crocker, S. Carr, and J. Rulifson met again in the summer and fall of 1968 to continue discussion of host-to-host protocol issues. Their early thinking was at a very high level, e.g., the feasibility of creating a portable front-end package which could be written once and moved to all network hosts; a host desiring to send data to another host would first send a data description to the receiving host which instructed the front-end package at the receiving host how to interpret data coming from the sending host. On Valentine's Day, 1969, the first meeting of host representatives and representatives from the NMC and NAC, along with the IMP contractor, was held at BEN in the middle of an enormous snow storm.

In April 1969, a series of working notes called Request for Comments (RFCs) was established, which could be circulated to let

others know what they were doing and to obtain the reactions and involvement of other interested parties. They called themselves the Network Working Group (NWG).

The NWG eventually grew quite large, with representatives from almost every host site in the network participating, and mountains of paper was circulated describing and commenting on various protocols. There were also occasional mass meetings. From about the time it was decided that he would go to DARPA until near the time he left DARPA, Stephen Crocker served as chairman of the NWG. By the beginning of 1972 the NWG had grown too large, but much of its work was done -- large numbers of hosts were communicating over the network. From this point onward, meetings were limited to those of an executive protocol committee which met to discuss general protocol issues and provide guidance for Crocker, and to those of various subcommittees, e.g., the group interested in the Remote Job Entry protocol. Even after the big meetings stopped, most participant working notes were circulated to most other participants in the network.

Gradually the activities of the NWG began to diminish. Many of the host site personnel who had originally been active moved on to other tasks, and new users joining the network tended to use the defined protocols rather than becoming involved in their



specification. As Crocker's time for the NWG group became increasingly limited, he appointed Alex McKenzie and Jon Postel to serve jointly in his place. McKenzie and Postel interpreted their task to be one of codification and coordination primarily, and after a few more spurts of activity the protocol definition process settled for the most part into the status of a maintenance effort.

Further activities of the Network Working Group will be described in the section below on the development of host-to-host protocol.

#### 1.4.2 Initial Subnet Design

BBN's proposal for the IMP was for the most part compliant with the requirements of the RFQ. In some important respects, however, the BBN IMP design diverged from those requirements or added constraints that were not in the RFQ.

The BBN design took the idea of inserting a communications processor between the host and the network to a logical extreme: it specified that the IMP be used only for communications functions, and that there be maximum logical separation between IMP and host. Thus, the design did not provide for IMP repacking of binary messages on behalf of a host or for doing character conversion for a host. Further, the design precluded all host programming of the IMP and any control of the IMP by regular hosts.

The initial subnet design also specified minimal control messages between an IMP and its hosts, many fewer than envisioned in the RFP. As the network later developed, it proved useful to add additional such control messages.

The IMP design called for a hardened IMP, which would be robust in the face of physical and electrical abuse. While statistics have shown that hardening did help, it was eventually decided not to be worth the added price of the hardware.

The capability to loop all interfaces was included in the design. This has proved to be of enormous operational importance.

A decision was made to reload IMPs initially from paper tape, and each IMP was provided with a paper tape reader. It was always intended that this procedure would sooner or later be replaced by loading through the network, and it was. The use of the paper tape reader at each IMP was probably a useful simplification in the beginning.

Program debugging was also specified to take place from a local terminal, in the interests of simplicity, with the knowledge that cross-network debugging could be added later. A cross-network debugging capability was added even before the first IMP was delivered.

A delivery schedule of one IMP per month in months eight through eleven after contract start, instead of all four at month nine, was assumed.

In keeping with the strict independence of host and IMP, the IMP was to gather statistics routinely and transmit them periodically to specified hosts rather than permitting hosts to control the IMPs' statistics-taking capabilities. This proved satisfactory.

The initial IMP design was responsive to the RFQ in one particular way which was changed at the first meeting between BBN, DARPA, and host representatives. The RFQ had called for one host per IMP and six circuits per IMP, although it also asked that more hosts per IMP be an option. Almost immediately it became clear that many host sites had more than one host to connect to a single IMP. Thus before the first IMP was delivered, the design was changed to permit two, three, or four hosts on an IMP along with five, four, or three lines. This was a simple change to implement.

In the area of the host-to-IMP protocol, the initial IMP design specified this protocol as required. Unfortunately, some aspects of the host-to-IMP protocol had significant detrimental effect on the design and performance of the other protocols. Particularly unfortunate have been the acknowledgment system, the retransmission system, and the message identification system initially suggested by the host-to-IMP protocol.

It is crucial for the IMPs to limit the rate of flow of host traffic into the net to the rate at which that traffic is being taken out, in order to prevent subnetwork congestion. The IMPs' first attempt, which was insufficient, took the form of suggesting that each message in a conversation should be held by the sending host until an end-to-end acknowledgment for the

previous message was received. This suggestion was adopted as part of host-to-host protocol upon which all the higher standard protocols are based. As a consequence, the bandwidth of a single host-to-host protocol connection is severely limited; given the ARPANET response time using 50 Kbs lines, waiting for a destination-to-source acknowledgment between messages typically limits connection bandwidth to about 10 Kbs, in contrast to the 40 Kbs possible with a constant stream of messages.

It was originally thought that the ARPANET would lose a message so seldom that there was no point in hosts ever bothering with message retransmission. Unfortunately, resolving various possible lockups has required the subnetwork to discard a message occasionally, and the topology of the network has evolved into long series of machines and lines that increase the probability of involuntary message loss. However, the host-to-host protocol followed the initial thought and did not provide for message retransmission. Given the realities of the probability of message loss in the network and given the host-to-host protocol, which is inordinately sensitive to any abnormality, the host-to-host protocol (and protocols based on it) has not proved particularly robust although it has been reliable.

As part of the host-to-IMP protocol end-to-end acknowledgment system described above, the host-to-IMP protocol

specified an 8-bit message identification number and suggested that all messages in a single conversation carry this same identification number; in fact, messages with different identification numbers were not guaranteed to be delivered in the order sent. Eight bits is probably insufficient to identify uniquely (for the purpose of possibly required retransmissions) outstanding messages when successive messages in a conversation are sent without waiting for an end-to-end acknowledgment. Use of the small 8-bit message identifier was one of the factors that prevented reliable high-bandwidth connections.

The IMP/host protocol has been changed so that it is no longer necessary to wait for the end-to-end acknowledgment; message order is now preserved except for priority considerations; cases requiring message retransmission are unambiguously reported to the sending host; and the message identifier has been expanded to a sufficient size.

### 1.4.3 Subnet Development

The first four IMPs were developed and installed on schedule by the end of 1969. No sooner were these IMPs in the field than it became clear that some provision was needed to connect hosts relatively distant from an IMP (i.e., up to 2000 feet instead of the expected 50 feet). Thus in early 1970 a "distant" IMP/host interface was developed. Augmented simply by heftier line drivers, these distant interfaces made clear that error control was needed on the host/IMP interface. Previously, it had been assumed there would be no errors on such a local hard wired connection.

By mid-year of 1970, a series of network performance tests were being carried out. These uncovered some flaws which were quickly corrected, and some problems which looked more worrisome. Also by mid-year, a rudimentary version of the network control center was established at BBN.

As the year wore on, sites continued to be added to the network, the IMP program continued to be improved, NCC development continued, the first 230.4 Kb circuit was tested between two IMPs, and design for a version of the IMP able to support direct terminal connection was begun. The latter was called the Terminal IMP (TIP).

In 1970 major problems with the IMP flow control and storage allocation techniques were demonstrated. It is interesting that even after these problems were demonstrated (and they were serious enough to completely halt network operation under certain circumstances), the network continued to give adequate service for many, many months while improvements were designed and implemented. The hosts were simply asked to not use the network in the way that caused the subnetwork problems, and the hosts did as they were asked.

About three-quarters of the way through 1971 the first two TIPS were delivered, providing ARPANET access for the first time to users without their own hosts or access to terminals on some other organization's host.

By the beginning of 1972 it was recognized that even the distant version of the IMP/host interface was not sufficient, and design for a IMP/host interface for use over communications circuits was begun. The evolution of the IMP/host interface is worth a little additional comment. The initial bit-serial, asynchronous, non-error-controlled IMP/host interface was essentially specified in the RFQ, in an effort to simplify network connection for the hosts. This non-standard interface may have been of some benefit in simplifying the host connection. However, its greatest virtue was the separation it put between



the IMP and the host. The IMP and host did not have to worry about each other's word size, and they did not have to worry about each other's timing constraints. It seems likely that having to worry about these issues would have delayed network operation. However, this interface also resulted in a hodge-podge of interface variations, each designed for more distant operation than its predecessors, and none except the first was very elegant. For any new network, which need not fear the now proven packet-switching technology, it would clearly be better to use an industry standard communications interface, e.g., HDLC, for every IMP/host connection.

In the first half of 1972 the TIP's capability was expanded to support TIP-to-TIP magnetic tape transfers. While this option was successfully used between two network sites, it was never very elegant. Also, a massive change in the IMP software was undertaken to correct the previously discovered flow control and storage allocation problems. In the second half of the year, the new version of the IMP program was released in many small increments, and the design of a new, ten times more powerful IMP was begun.

The beginning of 1973 brought the first satellite link in the network, from California to Hawaii. Also, with network traffic rapidly increasing, a number of subnet reliability

problems developed which had to be corrected. By mid-year, a pair of TIPs had been shipped to Europe, for use in Norway and London. These brought numerous operational problems. For the first time, circuits had to be obtained from a foreign PTT, the circuits were relatively slow at 9.6 Kb, and like Hawaii, these TIPs were on a long spur off the network rather than being doubly connected as IMPs typically are. During 1973, nodes continued to be delivered, but there began to be a low level of switching of node locations, to optimize the use of various IMP configurations and as sites came on and went off the network. Certain improvements were also made to correct problems with the routing algorithm. As 1973 ended the first very distant hosts were connected to the network over telephone lines.

In 1974 there were major efforts to make the network more operationally usable. Subnetwork reliability was improved as was TIP-to-host communication reliability. Methods for providing TIP access control and accounting and partitioning of logical subnetworks of hosts were developed. Methods were developed to selectively reload sections of IMP memory.

In 1975 network development slowed up and the network took on more and more of an operational appearance. Major network developments in 1975 included delivery of the first Pluribus IMP, modification of the IMP and TIP software to support more than

sixty-three IMPs in the network and attachment of the first two Satellite IMPs to the network. By the end of 1975 the network was under DCA management.

Looking back, the subnet development between 1969 and 1975 appears relatively smooth, although there were many times during that period when those intimately involved felt they were trying to solve one crisis or another. The network grew slowly enough, and the basic technology and implementation was flexible and robust enough, that many problems, both major and minor, which naturally cropped up with this new development were for the most part corrected before they obstructed the work of too many users. The fact that the network was also part of an experiment no doubt also made users more tolerant.

#### 1.4.4 Host Protocol Development

Specifications, generally called the IMP-to-host protocol, exist for the physical and logical message transfer between a host and its IMP. This protocol is not sufficient by itself, however, to specify the methods of communication between processes running in two possibly dissimilar hosts. Rather, the processes must have some agreement as to the method of initiating communication, the interpretation of transmitted data, and so forth. Although it would be possible for such agreements to be reached by each pair of hosts (or processes) interested in communication, a more general arrangement is desirable in order to minimize the amount of implementation necessary for network-wide communication. Accordingly, the host organizations formed a group (the Network Working Group or NWG, introduced above) to facilitate an exchange of ideas and to formulate additional specifications for host-to-host communications.

The NWG adopted a "layered" approach to the specification of communications protocols, wherein the higher layers of protocol use the services of lower layers; the advantages and disadvantages of the layered approach are discussed elsewhere in this report. As shown in Figure 3, the lowest layer is the IMP-to-host protocol. The next layer (called the host-to-host layer in the figure) specifies methods of establishing

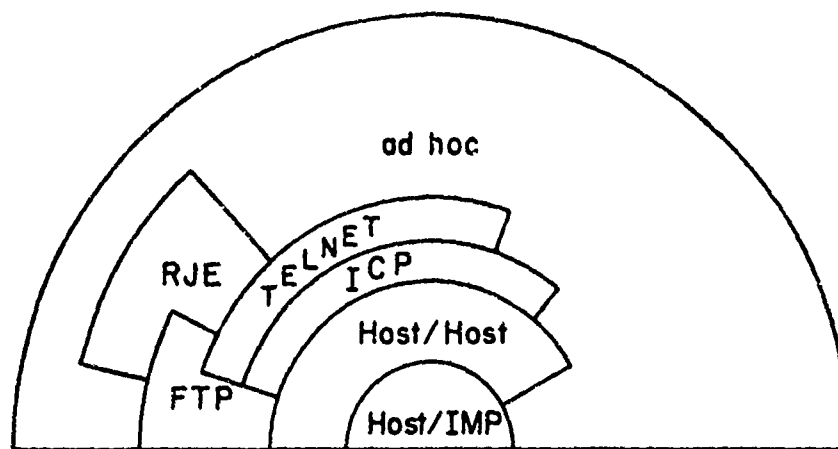

Figure 3 -- Layered Relationship of the ARPANET Protocols

communications paths between hosts, managing buffer space at each end of a communications path, etc. Next, the Initial Connection Protocol or ICP specifies a standard way for a remote user (or process) to attract the attention of a network host, preparatory to using that host. The ICP provides the analog of the user pressing the attention button at a local terminal on a host. In the next layer is the Telecommunications Network or TELNET protocol, which was designed to support terminal access to remote hosts. TELNET is a specification for a network standard terminal and the protocol for communicating between this standard terminal and a host. The next logical protocol layer consists of function oriented protocols, two of which, File Transfer Protocol (FTP)

and Remote Job Entry protocol (RJE), are shown in the figure. Finally, at any point in the layering process, it is possible to superimpose ad hoc protocols.

In the following subsections we discuss in some detail the events in the evolution of the host-to-host and TELNET protocols, and the events in the evolution of a number of other protocols in somewhat less detail.

#### 1.4.4.1 Host-to-Host Protocol

The Network Working Group was established in early 1969. By December 1969 an initial host-to-host protocol had been specified which supported communication between a terminal on one host and a process on another host. At a meeting in Salt Lake City in December 1969, the initial protocol specification was described to Lawrence Roberts of DARPA who was unhappy with it because the initial plan would not support transmission of electronic mail over the network. He instructed the Network Working Group to "go back and get it right."

By the spring of 1970 several successive versions of a host-to-host protocol had been developed, and a relatively formal meeting of the NWG was held at UCLA before mid-year at which the latest version of the protocol was described. Reactions to the described protocol were very negative. In June of 1970 there was a series of meetings held at UCLA and Harvard at which people from these two institutions tried finally to settle upon a host-to-host protocol and specify how it should be implemented. In August of 1970 some of the more general (and some thought more exotic) aspects of the host-to-host protocol being considered were ordered dropped from the protocol by Barry Wessler of DARPA, thus administratively clearing away some of those issues which had prevented agreement. The NWG discussion continued at the

1970 Spring Joint Computer Conference; in particular, there was discussion between Crocker and Roberts regarding the formality to be sought for the protocol, and DARPA approvals required, and so forth. Another NWG meeting was held at the Fall Joint Computer Conference in November 1970 in Houston, Texas.

At a NWG meeting held in mid-February 1971 at the University of Illinois, a subcommittee was appointed to look at the host-to-host protocol to see what changes were immediately desirable or necessary. This subcommittee went directly from Illinois to Cambridge, Massachusetts, where it met for two days, wrote an interim report, and then reconvened a month later in Los Angeles. It appears that with the efforts of this committee (known as the "host-to-host protocol glitch cleaning committee") the design of the ARPANET host-to-host protocol was finally coming close to being settled.

At about this same time DARPA was beginning to exert great pressure not only to get the host-to-host protocol settled but also to get it implemented by the hosts. At a NWG meeting at the Spring Joint Computer Conference in Atlantic City in May 1971, Alex McKenzie took on the task of writing a definitive specification of the host-to-host protocol -- not to invent new protocol, but to write down what had been decided.



In October 1971 the final big NWG meeting was held at M.I.T., and was preceded by a programmers' workshop at which differences in implementations were clarified and eliminated. In January 1972 a McKenzie document describing the protocol was published and the ARPANET host-to-host protocol has remained essentially unchanged since.

## 1.4.4.2 The Evolution of TELNET

Early in the development of the ARPANET it became clear that a major function of the network would be to provide remote use of interactive systems. To allow a user at a terminal (connected to his local host) to control and use a process in a remote host, as if he were a local user of that remote host, a special mechanism was required. The problems to be overcome are legion: for example, the typical host expects its interactive terminals to be physically attached to the individual ports of its hardware terminal scanner rather than logically attached via a multiplexed connection to the network; a given host expects to communicate only with terminals with certain characteristics (e.g., half-duplex, line-at-a-time, physical echo, EBCDIC character set, 134.5 baud) while a remote user's terminal might have completely different characteristics (e.g., full-duplex, character-at-a-time, no character echo, ASCII character set, 300 baud). The TELNET protocol was an attempt to provide the special mechanism necessary to permit such communication.

As early as 1969 a few hosts had been programmed on an ad hoc basis to permit terminal access from another host. In 1971 an NWG subcommittee was formed to consider the general problem of supporting interactive use of arbitrary hosts by users at arbitrary remote terminals. There was great controversy in the

committee discussions, focusing on four issues: character set, connection establishment, echoing, and interrupt capability. By late 1972 there was enough consensus so that widespread implementation of an early version of the TELNET protocol had been accomplished.

Despite widespread implementation of the early TELNET protocol, its heavy and effective use and numerous attempts to declare it complete, discussion of it continued. There were several problems with the early version:

1. Despite the attempt to permit a minimal implementation well suited to the constraints of small hosts, there was no well-defined minimal implementation. Even if some TELNET feature was not desired for a given implementation, it had to be provided in case some other implementation commanded its use.
2. The control structure was inadequate. For example, unless some exceedingly constraining assumptions were made, it was possible for the two ends of a TELNET connection to loop, commanding each other to take opposite actions.
3. The asymmetry of TELNET connections precluded one end from initiating certain functions, such as echoing

behavior. This seriously constrained the use of TELNET protocol for character communication between processes not serving terminals, a role for which it would otherwise have been well suited and for which it was already frequently used in the absence of any better protocol.

4. The issue of interfacing character-at-a-time hosts to line-at-a-time hosts was poorly handled.

By early 1973 it had become apparent that minor adjustments to the early TELNET protocol would not solve these problems and that some fundamental changes were needed. A new subcommittee met and, with the previous experience to guide them, developed several fundamental principles. These new principles, when added to the earlier principles of the Network Virtual Terminal and the remote interrupt (synch) mechanism, resulted in a revised TELNET protocol which solved most of the earlier problems that had precluded universal acceptance of the protocol.

There was such enthusiasm for the new version that a schedule for "rapid" (within the year) implementation was laid out. However, the implementation of the new TELNET protocol proceeded more slowly than expected. Only in the past year have implementations been widely available. In retrospect, there were several reasons for the delay in the implementation: 1) at the

time the revised protocol implementation was scheduled, implementation of the initial version had been completed and host system managers had not budgeted resources for a second implementation; 2) about this time DARPA's research interest in the network was declining and the network was entering a period of status quo operation; 3) despite initial belief that a clean method of phasing over from the initial protocol to the revised protocol existed, none was found by most implementors and consequently most chose to provide a complete implementation of the revised protocol to operate in parallel with the initial protocol; and 4) implementation for the most prevalent user host, the TIP, proved to be very difficult (because of the TIP's limited memory) and time-consuming, thus implicitly relieving pressure on the server hosts to implement the revised protocol. The new TELNET protocol has been the accepted standard for several years, and it is widely implemented and used.

#### 1.4.4.3 The Evolution of the Other Host Protocols

There are several other host protocols the evolution of which should be briefly mentioned.

The File Transfer Protocol started out as two protocols, a Data Transfer Protocol and a File Transfer Protocol. To over-simplify, the Data Transfer Protocol was to specify the format of data being transferred and the File Transfer Protocol was to specify how it was transferred. Eventually, the File Transfer Protocol alone was defined with a data portion and a control portion. After the final push to specify the FTP, relatively little additional work was done, consisting only of a little effort to clean up fundamental aspects of the protocol, and a good bit of work reconciling the "reply codes" that different hosts used to indicate FTP-related events.

Before a Remote Job Entry protocol could be defined by the NWG as a whole, UCLA's IBM 360/91 host, a batch oriented host, needed some RJE-like protocol with which to serve a few users who wanted early access to the computing power of that particular host. Thus, led by the UCLA group, a protocol called the Remote Job Service or RJS protocol was defined and implemented. The NWG eventually got around to working on the problem of a Remote Job Entry protocol and undertook a relatively massive effort to define such a protocol. However, by the time the RJE protocol

definition was finished, half a dozen or so hosts had already implemented to interim RJS protocol. Since these included most of the hosts on the network interested in supporting remote batch, there was little incentive for them to implement the new RJE protocol. Thus, today the RJE protocol is carefully specified but to our knowledge is not implemented anywhere, and the RJS protocol prevails.

Moving upward in sophistication, another protocol that was the subject of early discussion was one for graphics. Several versions of a graphics protocol were specified but until recently there was never widespread implementation of any of them. Recently, as part of the ACCAT experiment, an operational graphics protocol has been developed.

In addition to the host-to-host protocol which was finally specified after much iteration, a number of alternative protocols were suggested by various members of the NWG. Before the host-to-host protocol was settled upon, Richard Kaline and David Walden each suggested an alternative protocol. Even after the adoption of the host-to-host protocol, there was some discussion of experiments with a protocol derived from the Walden suggestion. More recently, as part of the DARPA-sponsored National Software works project, Robert Thomas, Stuart Schaffner, and their colleagues have designed and implemented a host-to-host

protocol known as MSG. Another protocol, known as TCP, deserves special mention.

Near the time of the formation of the International Network Working Group, as network interconnection began to be of great interest, discussions began on a standard inter-network protocol, particularly one which would correct some of the shortcomings of the ARPANET host-to-host protocol. At the AFIPS 1973 NCC in New York City a meeting was held at which certain ideas for a new host-to-host protocol were discussed. After some additional correspondence, Robert Kahn of DARPA and Vinton Cerf, then of Stanford, got together and designed a protocol known as TCP. Other members of INWG, perhaps not satisfied that TCP represented an international standard, continued developing still another host-to-host protocol (Cerf also participated in this later effort). TCP quickly became DARPA's choice of the host-to-host protocol to be used in situations where the ARPANET host-to-host protocol was insufficient or where inter-networking was required. With DARPA support, several TCP implementations were done and the protocol has come into relatively widespread use within the ARPANET. and its use is still spreading. TCP is scheduled to replace the ARPANET host-to-host protocol throughout the net by 1 January 1983. Meanwhile the host-to-host protocol that the rest of INWG was working on was finished, and documented, just as the PTTs and North American common carriers submitted the X.25



Report No. 4799

Bolt Beranek and Newman Inc.

standard to CCITT; so the INWG consensus protocol will most likely play little operational role in the ARPANET or elsewhere.

#### 1.4.5 Network Growth -- A Summary

In the following three subsections we consider three aspects of the growth of the network: the traffic growth, the growth of the network topology, and the increase in the number and type of hosts on the network.

##### 1.4.5.1 Traffic Growth

In early 1973, Roberts presented a curve of average host internode traffic growth for the network\* which showed the level of internode network traffic to be increasing at a rate of a factor of ten every ten months. Internode traffic means traffic sent from a host on one node to a host on a different node; i.e., it does not include traffic sent between hosts on the same node. Based on this rapid rate of growth, Roberts predicted the network would run out of capacity in nine months. As shown in the following figure, shortly after Roberts' prediction the rate of internode traffic growth decreased sharply to roughly a factor of two every twenty months. It is interesting to speculate on the reason for this sharp decrease.

-----  
\* L.G. Roberts, "Network Rationale: A 5-Year Reevaluation," Proceedings COMPCON 1973, February 1973, pp. 3-6.

### ARPANET HOST INTERNODE TRAFFIC

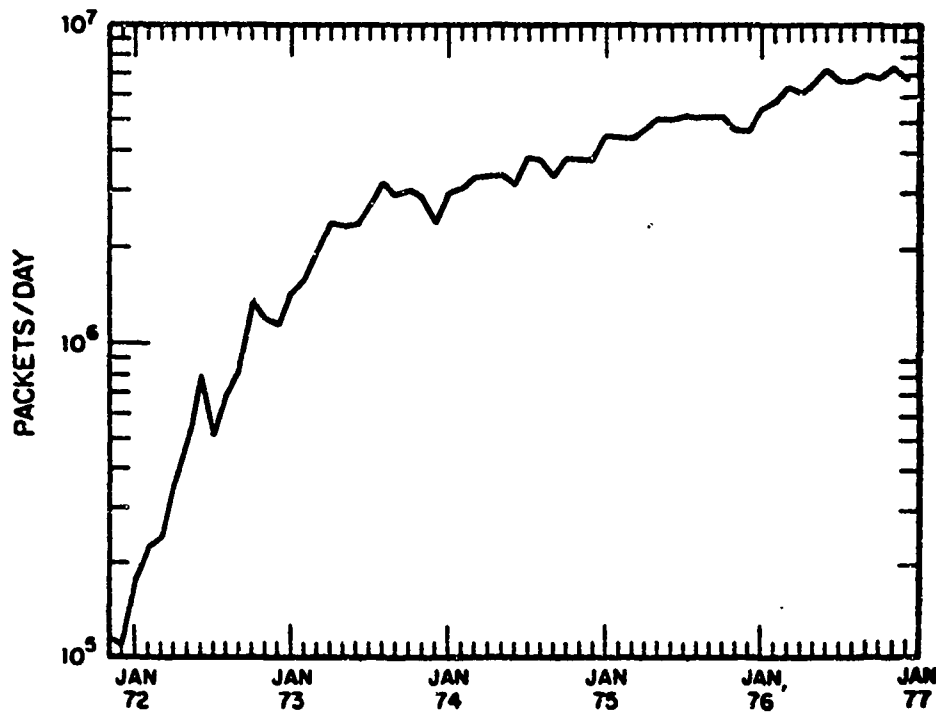

Figure 4 -- Growth in Average Host Internode Traffic

It can be hypothesized that the existing hosts (and the few new hosts that were added) were used remotely more and more and network traffic increased more and more, until the hosts (at least the popular time-sharing hosts) began to run out of capacity; this made it pointless for new remote users to attempt to get service, and resulted, in turn, in a leveling off of network traffic growth. Therefore, instead of the network running out of capacity as predicted by Roberts, it seems that the hosts ran out of capacity while the network still has capacity left.

As already stated, the traffic shown in Roberts' curve and in the figure above includes only internode traffic. There are two reasons for excluding intranode traffic. First, intranode traffic puts a burden on only one node rather than on the network as a whole. Thus when Roberts, for instance, was attempting to calculate the effects of host traffic on network capacity, he naturally excluded intranode traffic. Second, the available intranode traffic statistics include some amount of test traffic being looped from a host through its node and back to the same host, and there is no convenient way to separate this looped test traffic from actual data traffic between two hosts on the same node. It is believed, however, that there is actually a significant amount of real traffic between hosts on the same

node. For instance, Kleinrock reports\* that during a week-long measurement, the level of intranode traffic amounted to a daily average of twenty percent of the level of internode traffic, and in some one-hour intervals the intranode traffic level was as much as eighty percent of the internode traffic level. A scan of available long term statistics on inter- and intranode traffic shows that intranode traffic levels have averaged between twenty and forty percent of internode traffic levels. Thus the traffic curve given in the figure above should be scaled up by this factor if all traffic is to be included.

That intranode traffic is a significant portion of all network traffic is interesting and probably indicative of four phenomena. First, the IMP is a handy interhost interface, and once one is installed in a computer center to connect some host onto the network, there is very soon pressure to connect other computers in the computer center to the IMP so that desired communication between the computers is possible. Second, when two computers are connected to the same IMP so they may both communicate with other computers in the network, communication between the two computers themselves comes free and begins to happen even if it was not initially thought to be desired.

-----  
\* L. Kleinrock and W. Naylor, "On Measured Behavior of the ARPA Network," AFIPS Conference Proceedings, Volume 43, May 1974, pp. 767-780.

Third, the TIP (a host) has been chosen by several sites as the most flexible available terminal multiplexor and TIP-to-host traffic at these sites is likely to be intranode. Fourth, there is a (as yet still weak, but definite) tendency for hosts to be concentrated at a certain site and therefore often on the same IMP. The reason for this tendency is that, while some cynics would have guessed that every computer center manager is trying to build his empire as large as possible, in fact the world of computer center managers appears to include not only managers whose inclinations are as the cynics guessed but also many who dislike running computer centers but do so because they need the service supplied by the computer center. Once the network became available, some sites have arranged with some other sites that one site's computer was moved to a second site, and the second site managed it for the first site which used the computer over the network via a simple terminal concentrator. A further reason for this tendency (for hosts to be clustered) is the economy of scale possible when only one facility and staff is required for the operation of several computers.

#### 1.4.5.2 Topology

The first ARPANET node was installed at the University of California at Los Angeles in late 1969 and the next three nodes were installed in California and Utah.



Figure 5: The ARPANET in December 1969

By June 1970 three East Coast and two more West Coast nodes were added, as well as two cross-country lines.

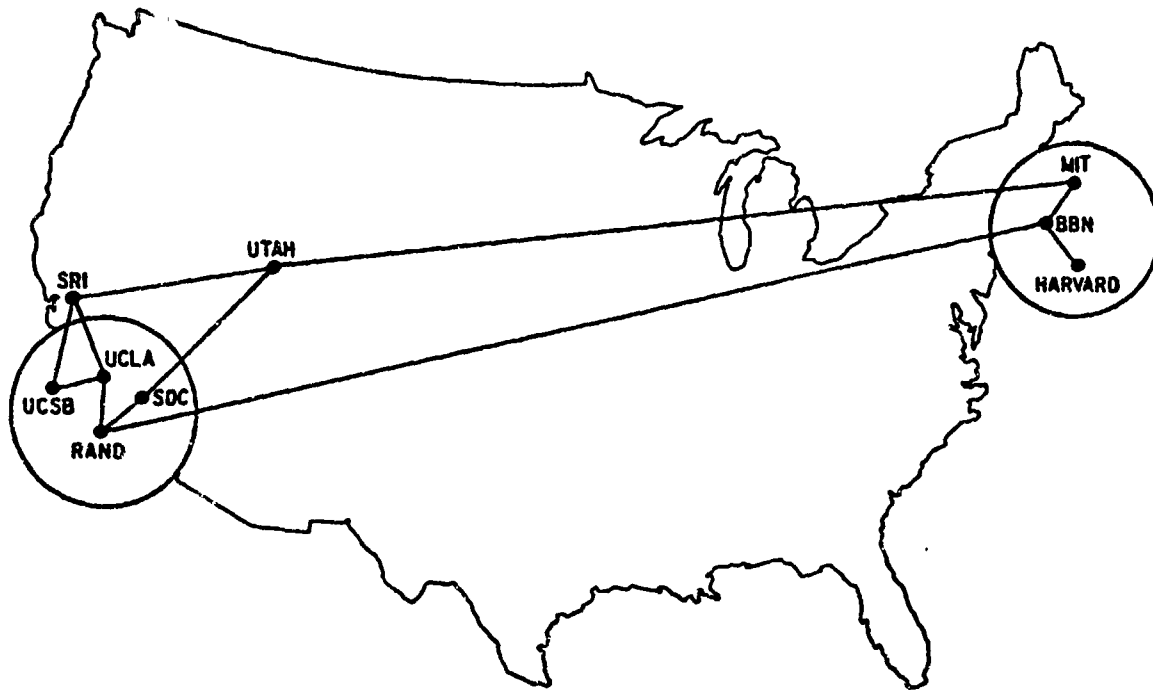

Figure 6: June 1970



IMPs continued to be delivered to the field at an average rate of approximately one per month, so that by late 1970 there were thirteen IMPs installed in the network. The IMPs were all entirely compatible, all being based on the Honeywell 516 computer.

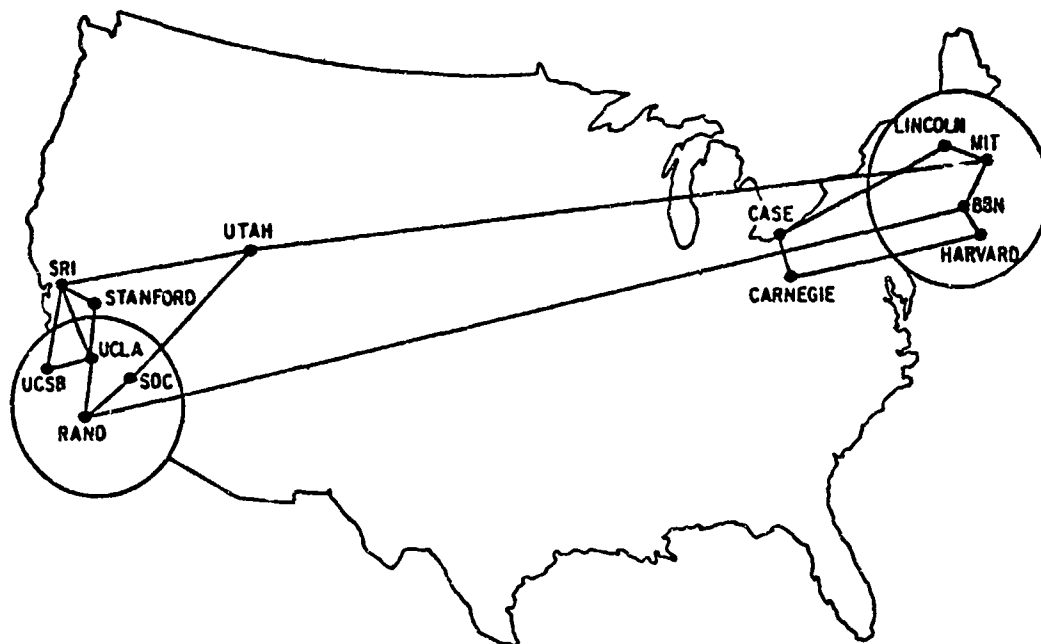

Figure 7: December 1970

By two-thirds of the way through 1971, two additional 516 IMPs had been installed, the prototype TIP was running at BBN, and two TIPs were operational within the network, at MITRE and AMES.

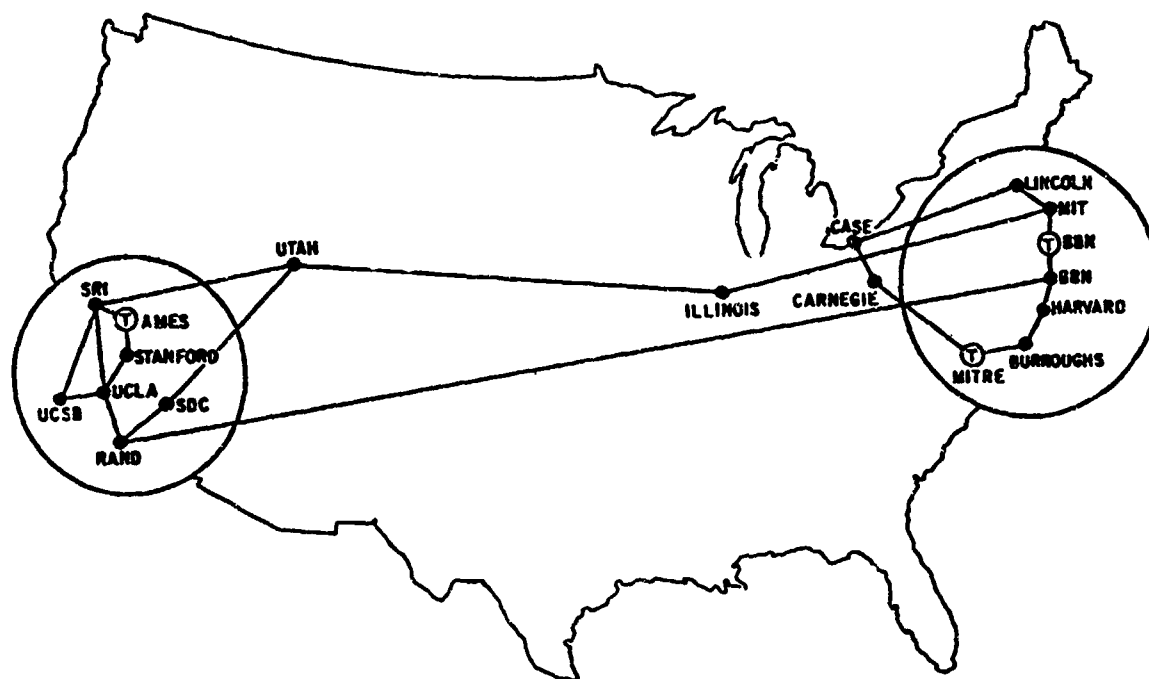

Figure 8: September 1971

The TIPs were based on Honeywell 316 instead of 516 computers and had as a component a 316-based IMP which was completely compatible with the 516 IMP but half as expensive. By early 1972 several additional IMPs and TIPs had been installed and the central part of the network between the East and West Coast clusters was beginning to fill out.

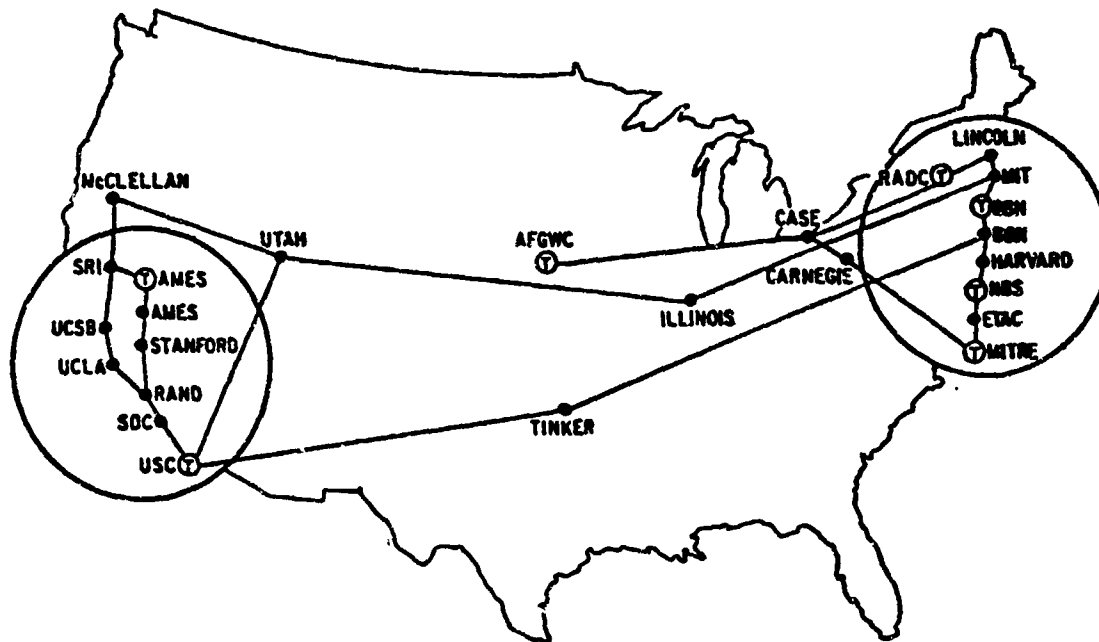

Figure 9: March 1972

By August 1972 a third cross-country line had been added and it was clear that in addition to the IMPs scattered throughout the center of the country, there were actually clusters of IMPs in four geographic areas, Boston, Washington. D.C., San Francisco, and Los Angeles.

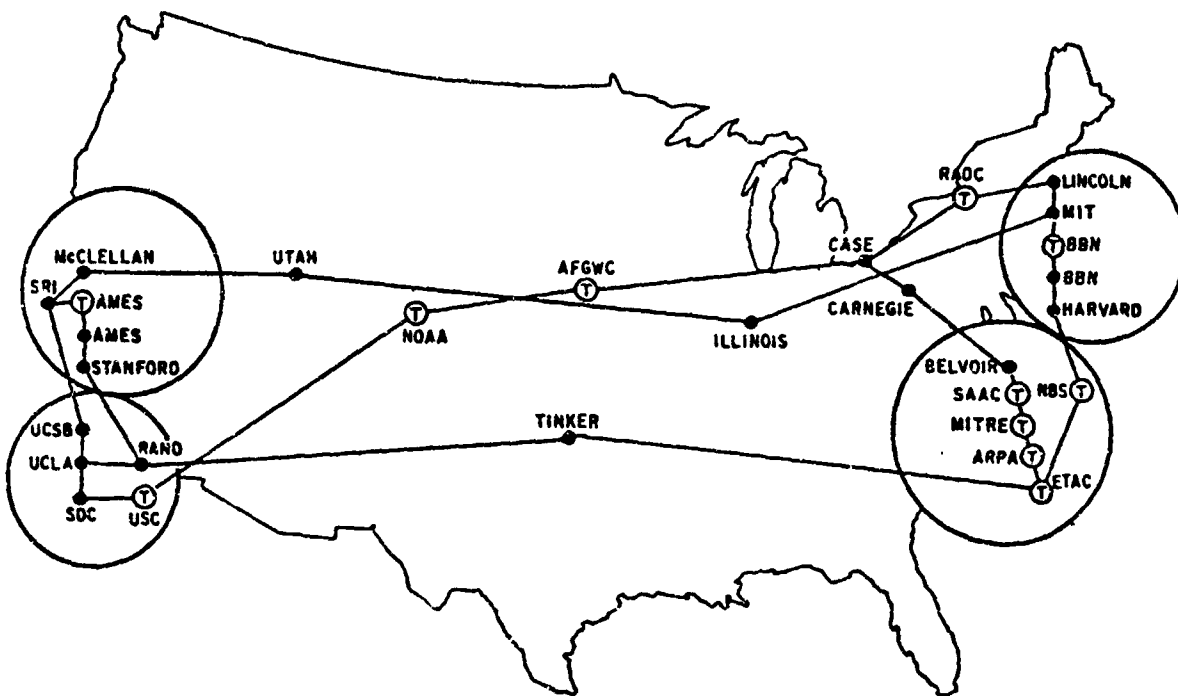

Figure 10: August 1972

There follow once-yearly maps for the years 1973 to 1977 with which the reader can follow the continued growth of the ARPANET topology.

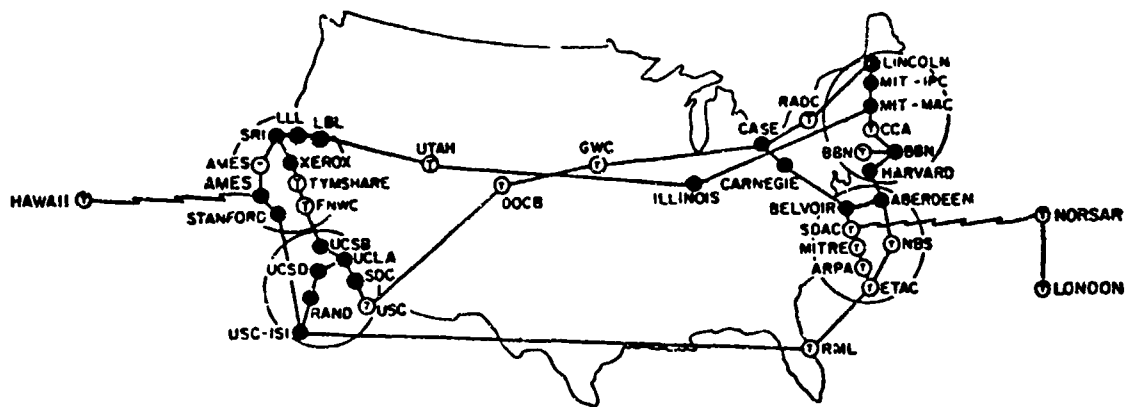

Figure 11: September 1973

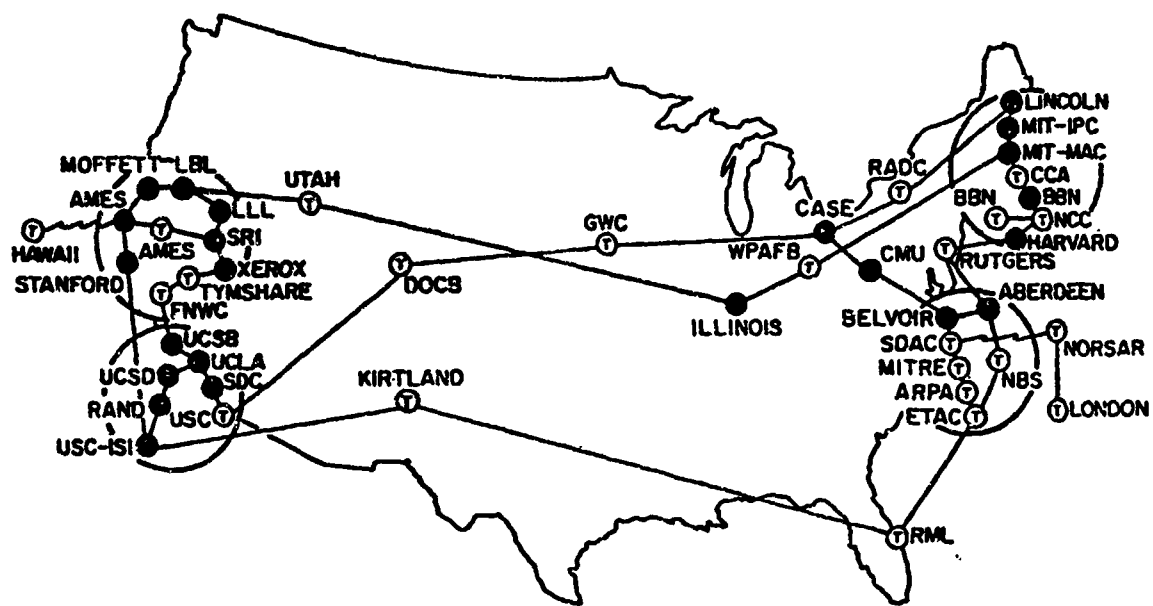

Figure 12: June 1974

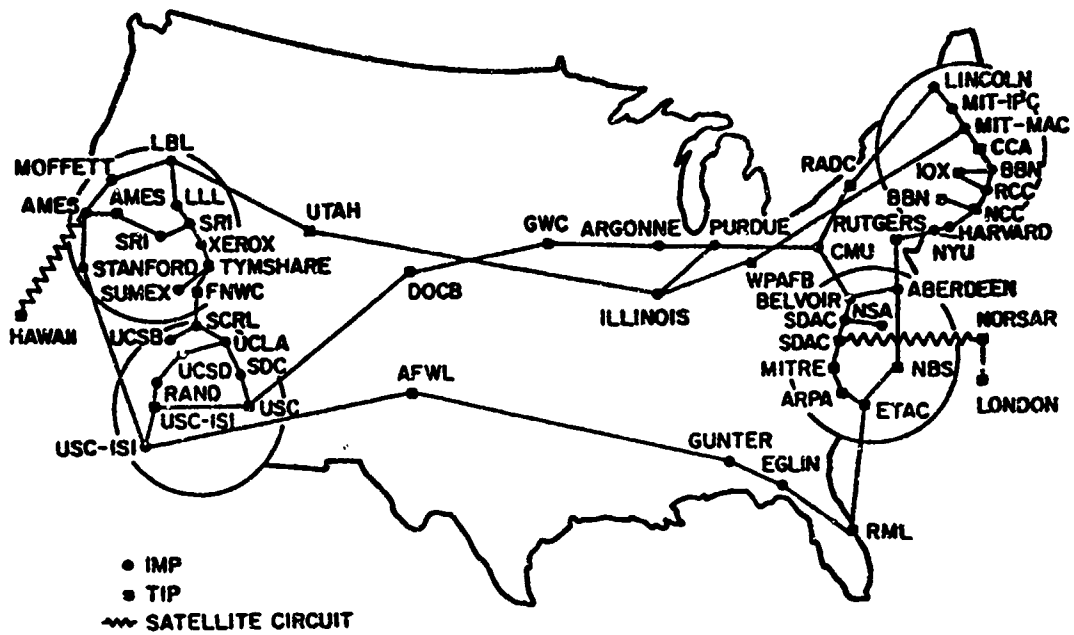

Figure 13: July 1975

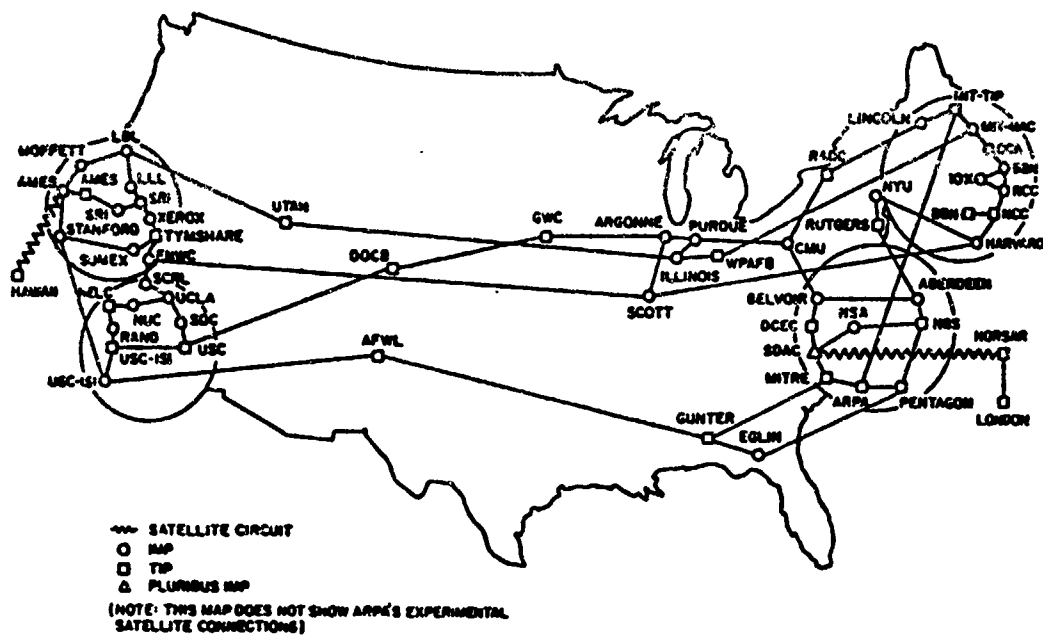

Figure 14: July 1976



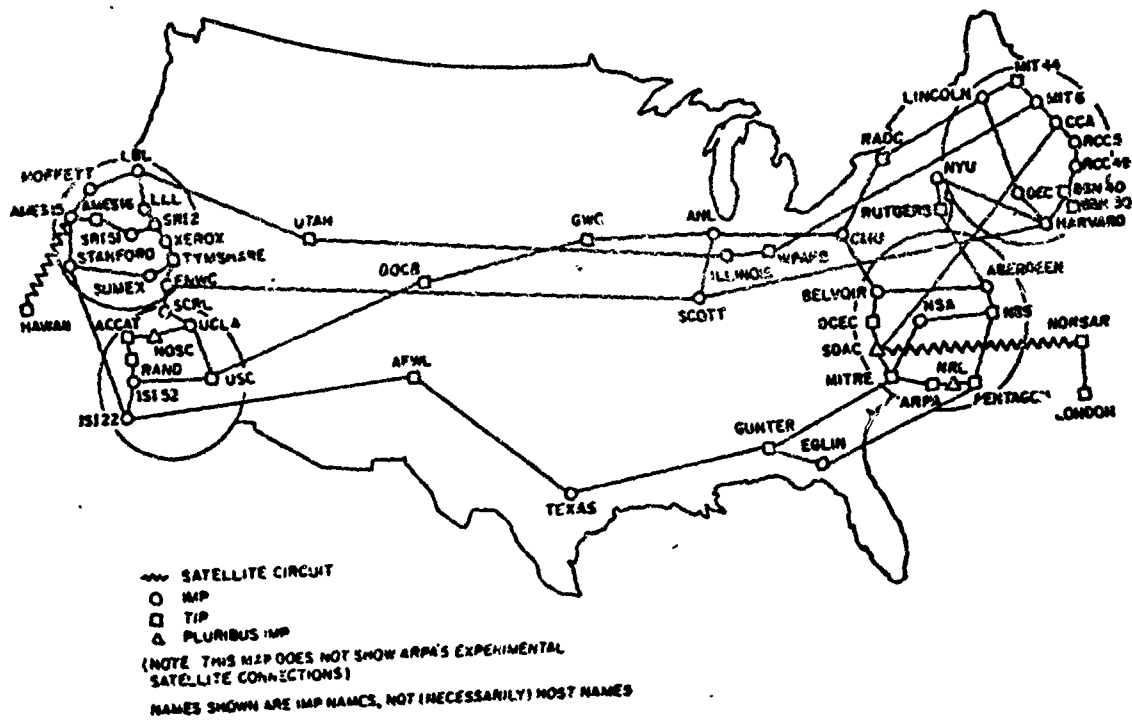

Figure 15: July 1977

Having shown the growth of the ARPANET topology through a series of geographic maps, it is interesting to consider the evolution of the topology on a more quantitative basis. We use the topologies given in the eleven maps shown above as the basis for the quantitative data shown in the Figure 16 chart. Columns 6 and 7 are missing the first six entries because the HAWAII, NORSAR, and LONDON nodes did not exist at the times the six earlier maps were made. The first three entries in columns 8 through 11 are missing because that information was not kept in the early days of the network. There are several interesting facts that should be noted from the chart. First, the number of network nodes has stayed about the same since 1975. Despite this, the network throughput has continued to increase. Next, note that intranode throughput actually is a significant fraction of total network throughput. Also, note the peak in average path length reached in 1974-75, and the subsequent decrease in average path length; selected lines were added to the network in 1975-76 as a direct response to network delay problems which occurred in 1974-75. Finally, note that in July 1975 and July 1977, the path from HAWAII to LONDON is equaled by other paths in the network; the NCC (in the Boston area) was 15 hops from both UCSB (Santa Barbara, California) and FNBC (Monterey, California) in 1975, and in 1977 SRI2 (near San Francisco, California) is eleven hops from NRL (near Washington, D.C.).

1	2	3	4	5	6	7	8	9	10	11
DEC69	4	2.00	1.33	2	---	---	---	---	---	---
JUN70	9	2.22	2.31	4	---	---	---	---	---	---
DEC70	13	2.46	2.76	6	---	---	---	---	---	---
SEP71	18	2.44	3.32	7	---	---	3.27%	2,892	3,121	6,013
MAR72	23	2.35	5.04	11	---	---	4.00%	11,633	21,073	32,706
AUG72	29	2.21	4.68	9	---	---	1.79%	682,502	287,953	970,455
SEP73	40	2.20	5.61	13	5.40	11	3.53%	2,893,130	742,746	3,635,876
JUN74	46	2.17	6.14	13	5.98	12	1.19%	3,125,955	1,513,777	4,639,732
JUL75	57	2.28	6.79	15	6.68	15	.67%	5,179,361	1,918,538	7,097,899
JUL76	58	2.45	5.26	11	5.13	10	.58%	6,627,968	1,961,726	8,589,694
JUL77	58	2.41	5.37	11	5.27	11	.94%	7,051,922	2,706,054	9,757,976

where the columns contain the following information:

Column 1: Date of Map  
 Column 2: Number of Nodes  
 Column 3: Average Connectivity  
 Column 4: Average Path Length  
 Column 5: Maximum Path Length  
 Column 6: Average Path Length, Minus HAWAII, NORSAR, LONDON  
 Column 7: Maximum Path Length, Minus HAWAII, NORSAR, LONDON  
 Column 8: Percentage of Node Unavailability  
 Column 9: Internode Throughput  
 Column 10: Intranode Throughput  
 Column 11: Sum of Internode and Intranode Throughput

Figure 16: Some Quantitative Data

There has been a good deal of actual measurement of the behavior of the ARPANET, and the most detailed discussion of this is presented in the paper entitled "On Measured Behavior of the ARPA Network" (L. Kleinrock and W.E. Naylor, AFIPS 1975 Conference Proceedings, Vol. 43, pp. 767-780).

## 1.4.5.3 Hosts

The first four hosts connected to the ARPANET were an SDS SIGMA-7 at UCLA, an SDS-940 at SRI, an IBM 360/75 at UCSB, and a DEC PDP-10 at the University of Utah. This beginning gave a good indication of the diversity of host manufacturer types and operating systems which would use the ARPANET. There follows a recent\* schematic map of the ARPANET (Figure 17) showing the various hosts. Notice that the hosts range from small PDP-11s to large IBM systems, with a scattering of very special hosts such as ILLIAC-IV, running a variety of operating systems from relatively standard ones provided by manufacturers to very special ones constructed by university researchers.

Figure 18 provides a breakdown of the numbers and kinds of hosts on the network. It is based on information compiled by the NIC for inclusion in the ARPANET directory. Some of these hosts share a single host port on an IMP. Also, each of the twenty-three TIPS in the ARPANET logically provides a host function although no physical host separate from the network node is required.

-----  
\* A sampling of such schematic maps covering the entire history of the ARPANET is provided in Appendix B.

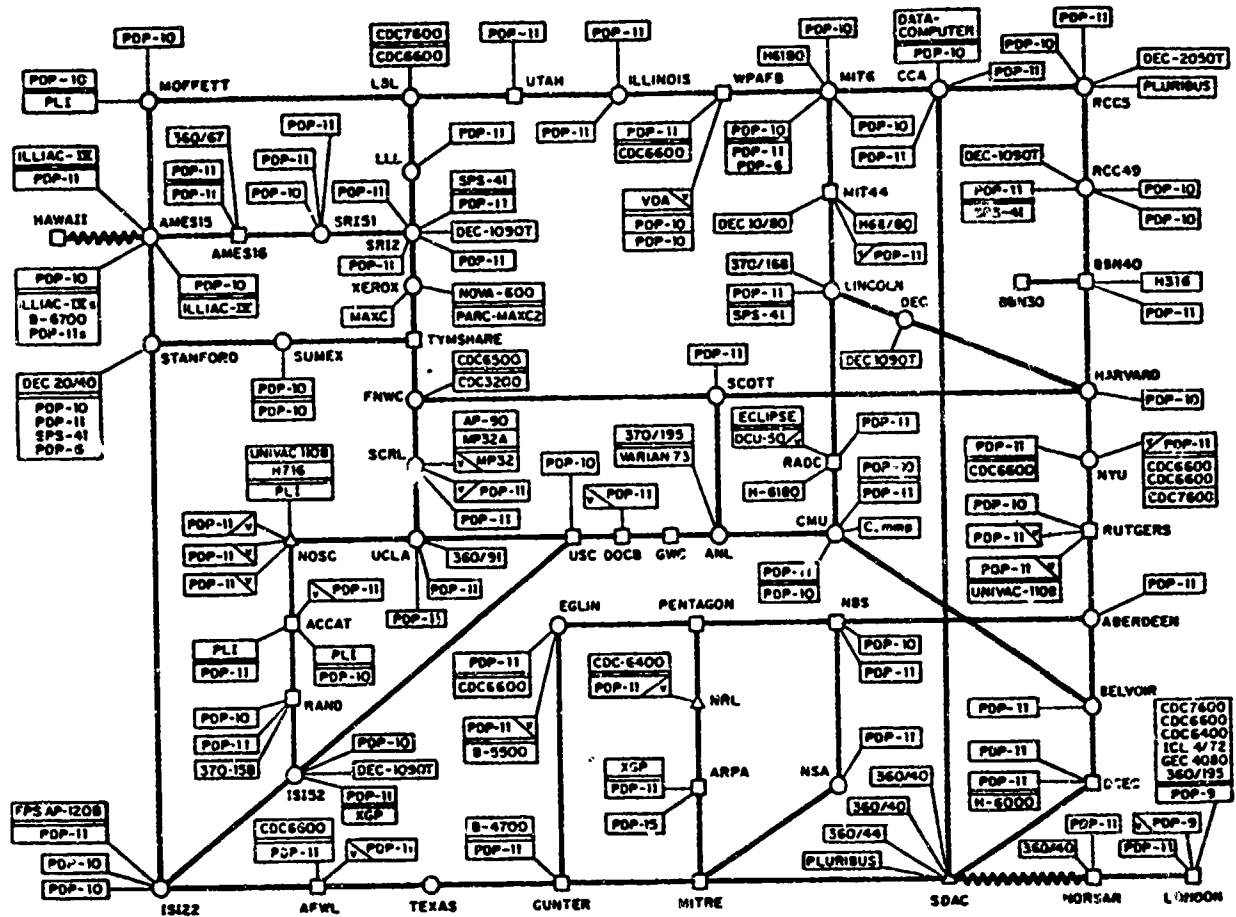

- IMP
- TSP
- △ PLURIBUS IMP
- AAA SATELLITE CIRCUIT

PLEASE NOTE THAT WHILE THIS MAP SHOWS THE MOST POPULATION OF THE NETWORK ACCORDING TO THE BEST INFORMATION OBTAINABLE, NO CLAIM CAN BE MADE FOR ITS ACCURACY. MOST COMPUTER CONFIGURATION SUPPLIED BY THE NETWORK INFORMATION CENTER. NAMES SHOWN ARE IMP NAMES, NOT (NECESSARILY) HOST NAMES.

Figure 17 -- ARPANET Logical Map -- June 1977

Hosts on ARPANET

BBN Pluribus 1 processor 2 processor 6 processor	1 4 1	61	PDP-11 PDP-11/10 PDP-11/20 PDP-11/34 PDP-11/35	11 3 2 1 1	360/40 360/44 360/67 360/91	3 1 1 1
Burroughs B-4700 B-5500 B-6700 ILLIAC-IV	1 1 1 1	24 12 4 3	PDP-11/40 PDP-11/45 PDP-11/50 PDP-11/70 PDP-15	24 12 4 3 1	360/195 370/158 370/168 370/195	1 1 1 1 1
Culler-Harrison AP-90 MP-32	1 2 3	1 1 1	Data General DCU-50 Eclipse-450B NOVA-800	1 1 1 3	3200 6400 6500 6600 7600	1 2 1 7 3
DEC PDP-1050 PDP-1080 PDP-1090T PDP-2040 PDP-2050T PDP-6 PDP-10 PDP-9	1 2 4 1 1 2 24 1	35	Honeywell G-4080 H-716 H-6000 H-6180 H-68/60 H-316	1 1 1 2 1 25 31	Xerox MAXC MAXC2	1 1 2
					Other SPS-41 Univac 1108 FPS AP120-B ICL NORD-10 TI-ASC	4 2 1 1 1 1
						10
						158

\*This data was obtained from the Network Information Center on-line "computers-query" function on September 8, 1977; in some cases two hosts may somehow share an interface to the ARPANET.

Figure 18 -- Summary of ARPANET Hosts

Report No. 4799

Bolt Beranek and Newman Inc.

III-94



### 1.5 The Impact of the ARPANET

The ARPANET has served well its original function as a testbed for a new computer communications technology. More recently the ARPANET has also given good operational service to a number of users who have come to depend on it for their computer communications service. However, a part of the original program plan for the ARPANET was technology transfer. For instance, it was thought that the transfer of interactive computer network technology would occur in three forms: (1) Dissemination of techniques and experimental results through the open scientific and technical literature. (2) Through the common carriers or other commercial organizations concerned with data transfer and dissemination, and (3) Through the military command and control centers for which the national Military Command System Support Center in the Pentagon serves as the focal point. The ARPANET's greatest success has perhaps been in this area of technology transfer.

Being an unclassified effort, implemented for the most part by individuals with an academic or research leaning, there have naturally been numerous papers written on the ARPANET. Two key sets of papers written relatively early in the ARPANET development were a set of five presented in a session at the AFIPS 1970 Spring Joint Computer Conference and another set of

five presented in a session at the AFIPS 1972 Spring Joint Computer Conference. Both these sessions were organized by IPTO and the two sets of five papers were specially bound together under DARPA-provided covers and distributed widely. We have already listed these and a number of other papers in the bibliographies provided elsewhere in this history. In 1975 IPTO commissioned Becker and Hayes, Inc., of Los Angeles, California, to prepare a bibliography of publications related to the ARPANET (Selected Bibliography and Index to Publications about ARPANET, Becker and Hayes, Inc., February 1976, 185p.). This bibliography lists 561 relevant documents and includes a subject index. The document is available from NTIS under accession number AD-A026900. A complete set of the papers in the bibliography was also collected on microfiche. There was also a large number of informal working papers distributed among the various groups and individuals working on the ARPANET development. Many of these are also covered in the Becker and Hayes bibliography. The National Bureau of Standards has also constructed a bibliography on computer communications which includes hundreds of ARPANET-related publications.

In mid 1971, Robert Kahn, then at BBN, suggested the possibility of a public demonstration of the ARPANET at the 1972 Spring Joint Computer Conference. Lawrence Roberts arranged instead for this demonstration to be held in October 1972 at the

first International Conference on Computer Communication (ICCC). This demonstration marked a key turning point in ARPANET development. It forced all participants in the project to thoroughly debug and test their network support and application protocols. It gave international visibility to the packet switching concept which, until then, had been viewed largely with scepticism by the communications community. Robert Kahn undertook the task of marshalling resources and personnel and with several key members of the ARPANET community planned and managed the full year effort which culminated in a successful demonstration. Fifty kilobit phone lines were leased from existing network sites to the conference site at the Washington Hilton Hotel, and an ARPANET TIP was set up in a demonstration room in the hotel for the duration of the conference. Dozens of members of the ARPANET community were involved. Manufacturers of all manner of computer terminals were invited to connect their terminals to the demonstration TIP. Throughout the conference hours, each day of the conference, there were individuals available to demonstrate the use of programs on ARPANET hosts from the manufacturer-provided terminals. A relatively thick booklet was written, and many copies made available at the conference, by means of which visitors to the demonstration area could follow "do it yourself" directions to use programs on many network hosts. A twenty or thirty minute motion picture about

the ARPANET and the promise of computer communications was produced and shown at the conference. Coming at a time when the TIP had not been available for a very long time, when only a limited number of terminals had been tried with the ARPANET, and when many hosts had completed the initial implementation of the necessary host software but few had had it running for very long, the ICCC demonstration provided an important stimulus for the ARPANET community to pull together and get the network in true operational shape. The demonstration itself was a spectacular success; with everything working amazingly well, many visitors remarked that the ARPANET technology "really is real" and carried this impression back home with them. The assurance with which Roberts promised the demonstration and the routine way in which he spoke of it while it was happening no doubt enhanced the impression taken home by the visitors, and belied the crash efforts and feelings of panic of the members of the ARPANET community who were called upon to execute the demonstration.

There have been numerous other demonstrations of the technology. Of course, many of these have been informal or relatively low key or relatively short, but in several instances the demonstrations have been truly major productions. Once for example, IPTO, with help from several members of the ARPANET community, took a demonstration team to Europe where a series of demonstrations was given for members of the NATO community over a two-week period.

There has been good success in transferring the ARPANET technology to other parts of the Department of Defense. The Defense Communications Agency procured two small networks, essentially identical to the ARPANET in function, for the purpose of gaining experience with the ARPANET technology. Called the PWIN and EDCN networks, the first of these was used in the WWMCCS effort and the second was used in connection with the successor to AUTODIN I. Two other networks essentially identical to the ARPANET but smaller have also been procured by other parts of DoD.

Where direct copies of the ARPANET were not appropriate, the ARPANET technology has nonetheless affected the characteristics of new DoD networks being built. For instance, the new DoD common user network, AUTODIN II, being constructed by DCA, is explicitly a second generation ARPANET.

Outside the U.S. military, the commercial world has begun to use the ARPANET technology or variations on it. Several companies have filed with the F.C.C. or already been licensed to offer communications services based more or less directly on the packet-switching technology developed in ARPANET. Among these are Telenet Communications Corporation (for which BBN arranged the financing and Lawrence Roberts was President,\* Tymnet,

-----  
\* Now with GTE Subscriber Network Products.

Graphnet, IT&T, and AT&T. Because of its access to substantial ARPANET expertise, of the several common carriers Telenet has used the ARPANET technology most directly. Telenet now serves about eighty cities in the continental U.S. and has made arrangements to connect to several foreign networks and serve several foreign cities. Tymnet initially developed in parallel to ARPANET as a means of making the time-sharing services of Tymshare available to a wide geographic area, and used a substantially different although related communications technology; however, a new version of Tymnet being built uses techniques closer to those developed for ARPANET. Graphnet, IT&T, and AT&T all have announced their intention to provide public packet-switching services.

A number of U.S. companies have also procured or are procuring private corporate networks utilizing many of the techniques developed for ARPANET. For instance, it was recently announced that Citibank of New York City has constructed (by contract to BBN) a private network very similar to the ARPANET. An increasing number of commercial RFPs call for packet switching or for functions which can only be provided using packet switching. A number of companies have taken advantage of the fact that the ARPANET technology is in the public domain to obtain the listings of the ARPANET software.

Several PTTs (the foreign national Postal, Telephone, and Telegraph authorities) have made a commitment to the development of packet-switching networks, there have been several foreign research networks, and several international networks are being developed or are under consideration. There follows a list of some of these networks:\*

CIGALE -- an operational network developed by a French government research agency.

RCP -- built by the French PTT and operational as a testbed.

TRANSPAC -- under construction by the French PTT and scheduled to become operational for public use in 1978.

EPSS -- an experimental packet-switching service built by the UK PTT which became operational in 1976.

CTNE -- a packet-switching service operated by the Spanish PTT.

Datapac -- a packet-switching network built by the Trans-Canada Telephone System which is in the early phases of operation.

-----  
\* More detail on this list may be found in "Planned New Public Data Networks", P.T. Kirstein, Computer Networks, Volume 1, Number 2, September 1976, pp. 79-94; Kirstein is himself a member of the ARPANET community and was instrumental in arranging the installation of the London node of the ARPANET.

JIPNET -- practically a copy of the ARPANET built in Japan.

EIN -- the European Information Network, built jointly by the U.K., Switzerland, France, and Italy and strongly influenced by CIGALE.

EURONET -- a network under discussion by the European Economic Community, initially to use the EIN technology.

No doubt there are other networks besides those mentioned above in the planning phase or under construction. With so many networks coming into being, technology exchange and standards become important issues. From the time of the 1972 ICCG, representatives of various countries and institutions interested in computer networks met informally to discuss their experience and to consider possible standards. In 1972 the International Network Working Group (INWG) was formed. Modeled on the ARPANET Network Working Group, Vinton Cerf of the ARPANET community was selected to be INWG's first chairman and DARPA offered the services of the the ARPANET NIC to coordinate and distribute INWG working notes. Later INWG became associated with the International Federation for Information Processing, DARPA cut back its NIC support, and DARPA's role in INWG decreased. From its beginning, INWG was a forum at which techniques other than those used in the ARPANET were considered; nonetheless, the ARPANET for a long time remained the one big, existing network against which new ideas were compared.



The international packet-switching standardization effort has been especially effective. With the urging of Datanac, Transpac, Telenet, and the UK PTT, CCITT (the international communications standards organization at which all of the world's communications authorities are represented) has with remarkable speed adopted standards for connecting hosts to packet-switching networks and packet-switching networks to each other. Known as X.25 and X.75, these standards clearly address, for purposes of international communication, issues which were first seen to be of importance in the ARPANET development, perhaps where the ARPANET was seen to be deficient.

While today the primary purpose of the ARPANET is the operational transmission of traffic, it is still in the main stream of packet-switching network development. For example, ARPANET research is underway to develop:

- more efficient and loop-free routing algorithms
- multi-destination, broadcast, and group addressing capabilities
- improved network flow control and congestion control mechanisms
- host attachment to more than one node

- logical host naming (i.e., to permit a single host to have more than one logical name)
- host interface enhancements to permit internetwork routing.

### 1.6 Maturity and Handover to DCA

A memorandum of agreement was worked out between DARPA and DCA for management of the ARPANET to be transferred to DCA as of July 1, 1975, with a six-month phase-over period from July 1 until December 31, during which DARPA would continue to help DCA with ARPANET management while DCA acclimated itself to the job. The memorandum also called for a detailed transition plan to be written which was completed by June 1975.

Along with the transfer of ARPANET management from DARPA to DCA, the technical functions that had been being performed at RML were also transferred to DCA and the procurement functions were transferred from RML to DECCO, which is a field activity of DCA.

There are several aspects of the memorandum of agreement and the transition plan which are worthy of mention here. The network was to be an operational DoD facility, to be used solely for government business. The concept of "ARPANET sponsors" was invented with sponsors being those users or collections of users (e.g., DARPA, NBS) who originally owned ARPANET equipment before management of it was turned over to DCA. Ownership of the equipment was to remain with the sponsors. DCA was to finance the operation and maintenance of the network through use of the DCA managed Communications Industrial Fund, which would recover its costs by a pro-rated allocation to sponsors based on the

equipment used by the sponsors. DCA was to contract initially with BBN and SRI to perform the ARPANET operations and maintenance and NIC functions, and with NAC initially if topological consulting was needed; it was clearly implied that DCA could retain other contractors to perform these functions eventually and certainly after the first year. DCA was to operate the network for a period of three years and thereafter if necessary until equivalent service could be provided on a military network.

## 2. OBSERVATIONS

For many of the people in government, at the major contractors, and in the participating universities and research centers the development of the ARPANET has been an exciting time which will rank as a high point in their professional careers. In 1969 the ARPANET project represented a high risk, potentially high impact research effort. The existence of the net in practical useful form has not only provided communications technology to meet many short term needs, but it represents a formidable communications technology and experience base on which the Defense Department as well as the entire public and private sectors will depend for advanced communications needs. The strong and diverse experience base generated by the ARPANET project has placed this country ahead of all others in advanced digital communications science and technology.

## 2.1 Social Issues

Somewhat expectedly, the network has facilitated a social change in the United States computer research community. It has become more convenient for geographically separated groups to perform collaborative research and development. The ability to easily send files of text between geographically remote groups, the ability to communicate via messages quickly and easily, and the ability to collaboratively use powerful editing and document production facilities has changed significantly the "feel" of collaborative research with remote groups. Just as other major improvements in human communication in the past have resulted in a change in the rate of progress, this social effect of the ARPANET may finally be the largest single impact of the ARPANET development.

A non-trivial question of considerable importance to the country is why the ARPANET project has been so successful. It would certainly be nice if the same formula could be applied to other pressing national needs. While timing, accident, and luck must not be discounted, it is possible to identify several possible contributing factors:

- o Despite the fact that the ARPANET was a government project and further despite the fact that it was run within the Defense Department, it was possible, at least

initially, to free the research and development from some of the constraints which often seriously hamper other activities. First, the project was entirely unclassified. Second, the provision of network service was for a very long time provided to government contractors as a "free good"; this allowed people to experiment with the use of the network without being forced to make early and probably ill-advised cost/benefit decisions. Third, despite a valid government and Defense Department concern about unauthorized use of government facilities, it was possible to build the ARPANET without complex administrative procedures for access control. Finally, the ARPANET did not have to interconnect directly with other existing communication systems; it was possible to explore line protocols and interface standards de novo, in the best ways that could be devised. Thus, the ARPANET program was incredibly free of "artificial" requirements and was able to concentrate intensively on the primary required research and development. Much later in the project, after success had been assured, it was relatively easy to reopen consideration of some of these issues; and at the current time, for example, the Defense Communications Agency is charging user groups

for network access, and there have been experiments (using private line interfaces) in the transmission of classified data over the ARPANET, and research was done on how to implement network login procedures, etc., etc.

- o A very convenient fact was the common DARPA support of both the "network authority" and the initial early group of network users. It was possible for DARPA to strongly encourage a cooperative attitude and cooperative engineering at the time in the project when such cooperation was most critically necessary.

In sum, the project was an illustration of what can be accomplished with strong technically sophisticated central management, adequate resources, and a clearheaded undeviating concentration on the central research and development issues.

The largest single surprise of the ARPANET program has been the incredible popularity and success of network mail. There is little doubt that the techniques of network mail developed in connection with the ARPANET program are going to sweep the country and drastically change the techniques used for intercommunication in the public and private sectors. By hindsight, one can easily see the reasons for this success. The primary prior existing communications techniques (the U.S. postal service and the telephone) have certain serious deficiencies:



The postal service has become more expensive and its performance is measured in days for delivery of letters. In the case of the telephone, our increasingly mobile society makes it difficult to reach the desired person (busy people are hard to reach in any case), and reaching 10 distributed people within a short period of time is essentially impossible. Leaving telephone messages works if a careful system is established and a travelling individual checks back with his answering service or secretary frequently, but it is often inconvenient and is usually limited to the prime shift working day of the secretarial world. To find a busy person able to accept a phone call at the time you make it is truly unusual, and some officials have desks covered with little pink slips reporting on telephone messages with requests for return calls. Into this milieu was dropped a technique of network mail where at any time of the day or night one can send a message to any number of other people and expect that message to semi-instantaneously be available in the computer mailbox of all the recipients. Then one only has to assume the habit on the part of all individuals using the system to occasionally check their mailboxes when they are free and not at a meeting, and the performance of the communications represents an immeasurable improvement over the postal service or the telephone. With the addition of sophisticated tools for answering messages, filing messages, forwarding messages, and categorizing messages, the

system takes on yet another step function of performance over the alternate possibilities. In the space of just a couple of years this "computer center curiosity" became a smashing success on the ARPANET; there was a sufficiently large community of individuals who wished to communicate, and they all were relatively mobile, and the system overnight became a way of life. The implications of this kind of success are enormous. Perhaps such advances would have eventually come anyway, but there is no question that the ARPANET program provided a truly convincing demonstration of the power of this approach. The change will not be overnight, because it does depend upon the availability of terminals accessible to wider and wider populations, but commercial systems are already available and substantial DoD experiments are already under way.

## 2.2 Technical Lessons

Leaving the broad social plane, the ARPANET program provided several technical lessons which are worthy of general comment:

### 2.2.1 Terminal Handling

Rather early in the ARPANET program, it became clear that terminal access to the net via the main host computers was an inadequate approach; many classes of users required direct terminal access to the net in order to use major hosts at other locations. The first response to this pressure was the design of the Terminal Interface Message Processor (TIP) by the ARPANET prime contractor, Bolt Beranek and Newman Inc. The TIP was designed to address a limited problem: to handle character-oriented asynchronous terminals only and to be an integral part of the network authority and not available for user programming or special user features. This limited goal and hard-nosed attitude permitted the rather rapid completion of the TIP design, the fielding of many TIPs, and the rapid availability of widespread terminal access to the network. Thus, the TIP effort was extremely successful in reaching its limited goal.

Unfortunately, but perhaps not surprisingly, the limited goal and absolute restriction on user programming created considerable unhappiness in portions of the potential user community, and created considerable pressure for other "better" terminal access techniques. Some of the complaining was fully justified; this approach to servicing interactive character terminals had "leapfrogged" a whole segment of the industry that

was concerned with batch processing and the use of synchronous line disciplines from such batch processing units. Other complaints were less rational and more self serving, where some groups really wanted "a computer of their own" under the guise of obtaining terminal access to the ARPANET. Still other criticism was based on an honest difference of opinion as to the relative ease of designing and deploying a terminal access device that would permit user programming and would handle a broader class of terminals. Finally, some criticism was provided by highly sophisticated users who were used to the terminal support "services" provided by the most advanced large hosts, and did not like the limited services provided by the tiny mini-host resident in the TIP.

In response to this pressure, DARPA for a time supported the development of a device called the "ARPA Network Terminal System" (ANTS). This was a system based on a PDP-11 which was intended to provide user programming ability, the handling of synchronous terminals as well as asynchronous terminals, and a more powerful set of services to the terminal user. Unfortunately, the goals were somewhat ambitious and, although a few ANTS were put into the field, the configuration management of the program, the difficulty in debugging fielded versions of the system, and delays in implementation eventually led to a cessation of DARPA support for the effort. In response to a somewhat different set

of requirements, another attempt was made with a system called "ELF". Here DARPA support was provided to try to standardize, improve, and deploy a PDP-11 based terminal support software system which had been independently developed for a particular project. Again, the hope was to permit user programming and the handling of a wider class of terminals. From the viewpoint of deployment, the efforts to use ELF were much more successful; goals were far more limited, and more attention was paid to orderly development and maintenance. However, ELF has probably been more useful as a base for individualized mini-hosts serving local specialized host functions than as a means of widely distributed network access for large numbers of terminal users. At the time the ARPANET was transferred to DCA, primary terminal access was still either through the main network hosts or via the many TIPs in the network. There are several morals to this history. First, it is extremely difficult to build a system which can handle all possible terminals; it is a bit like the "everything" machine and leads to an unlimited expansion of the problem. Second, very great attention must be paid to software configuration management, central program design and release, central maintenance and software support, and close control of program changes if an evolving computer-based device is to be deployed in considerable numbers around the network. There is still an open technical question whether such a device could be

sensibly and cost-effectively fielded in a way which would permit both some level of user programming to tailor the functions of the device and a standard set of controlled basic services; at this point in the development of the technology a conservative approach precludes such user programming if a device is to be widely deployed.

Another related aspect of the terminal handling problem has to do with the management extent of the network authority. It was discovered that when an unsophisticated user typed at a terminal in a remote location and something went wrong (that is, the proper response was not received), the user typically "blamed the network" despite the fact that any number of possible things: the terminal itself, the local modem, the local line, the modem at the other end of the local line, the terminal handling device (e.g., TIP), the network itself, the eventual host computer, or any similar point on the return path, could have been at fault. Thus, it is extremely important that the network authority have adequate administrative control over the entire collection of equipment from the terminal right through to the host computers if it is to be in a position to respond to such unstructured outcries of rage from the end terminal user. During the ARPANET program, numerous "crisis" incidents were precipitated by the failure of equipment which was not in any way under the control of the network authority. [Perhaps the best single example was

difficulties in the local on-base telephone system at Ames where it took a massive effort to eventually uncover the offending equipment and where the network authority was forced in its own defense to participate and lead in the massive debugging activity even though the offending device eventually found was clearly outside the network authority's control.] The generalizable lesson from this kind of history is that devices that attach to networks must be extremely clearly in somebody's camp of responsibility. Either the device must clearly belong to the network authority and must have built-in techniques for debugging and failure location, or the device must clearly belong to the host organization or some other well identified group who understands its responsibilities for maintenance and trouble location; devices cannot sit in cracks between different authorities. Although this idea is really quite simple, it is frequently overlooked.

A final point on the general terminal handling problem has to do with the location of the "intelligence" for dealing with terminal related matters. In general, the data processing power can either be in the terminal itself, in the terminal handling network port (e.g., the TIP), in the eventual final host computer or, of course, distributed among these three locations in some way. As the cost of data processing is dropping, more and more intelligence is appearing in the terminal itself and this entire



Report No. 4799

Bolt Beranek and Newman Inc.

matter must be periodically reviewed to ensure that the system performance can take advantage of technological change.

### 2.2.2 Reliability and Fault Isolation

At the outset of the ARPANET design considerable effort was expended toward built-in techniques of fault isolation and recovery. For example, IMP-to-IMP circuits could be cross patched for fault isolation, and IMPs themselves had power fail recovery mechanisms and mechanisms for reloading one IMP from a neighbor. As the network grew, it was therefore somewhat of a surprise that the initial efforts down this path were not nearly enough. Over the life of the ARPANET program, there was a nearly continuous effort to add techniques and improve existing techniques for fault isolation, rapid recovery, and containment of failures. The lesson probably is that it is difficult to have too much attention to fault isolation and recovery mechanisms. Many interesting techniques were slowly added to improve the network's ability to cope with trouble:

- o For critical pieces of code such as the routing computation, the code itself was checksummed before it was operated. Similarly, key data structures were checksummed before they were accessed. This kind of protection was added when it was discovered that the trouble in these particular classes of computations could cause network-wide failures rather than simply local difficulties.

- o It was discovered that dial-in modems for remote terminals could break or "hang" and there was no simple way to discover this had happened. A technique was designed wherein a centrally located autodialer controlled by the network authority used an out WATS line to periodically dial and test all dial-in ports all over the network (at least in the continental United States).
- o It was discovered that when a difficulty occurred in an IMP which caused an automatic program reload, the necessary debugging information was lost and the trouble would likely recur. A technique was added to automatically dump offending code before a reload was attempted, which then permitted comparison with a master copy and improved capability for debugging.
- o The ARPANET program was forced to cope with the simultaneous need for a twenty-four hour a day continuously operating reliable system and at the same time relatively constant levels of growth, modification, and change. After some early false starts when large changes introduced periods of substandard performance, a technique was evolved whereby greater attention was paid to dividing a large change into small incremental

changes that were compatible with the previous system. Then, when trouble occurred, debugging could be concentrated on the small incremental change or retreat taken to the previous release.

- o As network users began to depend upon a few particular "service" hosts for a wide variety of services, including message services, it became more important that such hosts maintain availability to the network. In some cases, a host might be operating adequately as perceived by its own local operators and yet in some way not be properly servicing the network connection. A technique was evolved whereby the network authority added software tools to "watch" these particular critical hosts and was then in a position to urge corrective action by the local host authorities if and when necessary.

### 2.2.3 Maintenance Management

In the early years of the ARPANET program, the IMPs and TIPS of the network were maintained by subcontract to the manufacturer of the basic mini computer (Honeywell). This represented a cost-effective approach because Honeywell had maintenance facilities in many cities. However, this rather standard form of computer maintenance was simply inadequate for the high reliability requirements of the ARPANET. After a time, maintenance of the network nodes was undertaken directly by Bolt Beranek and Newman Inc., the network prime contractor, and special new techniques were developed which greatly improved the average nodal reliability. In particular, techniques of central maintenance management were developed wherein a very strong team of hardware and software experts at the central Network Control Center acted in close concert with a small number of field personnel who became highly expert in the IMP and TIP machines. The central staff could use the network itself to observe the behavior of an offending node and it could talk through difficulties with the local maintenance engineer. Further, the people in the field became much more dedicated and responsive to ARPANET difficulties as compared to time-shared Honeywell personnel who had to take responsibility for many different kinds of equipment in their geographical territory. This approach to maintenance probably has important benefits for other distributed

systems, especially as those systems will increasingly be interconnected in networks and thereby accessible to central maintenance.

## A. BBN ARPANET Bibliography

## A.1 Technical Reports

- AD682905 BBN Report No. 1763, "Initial Design for Interface Message Processors for the ARPA Computer Network", January 1969.
- \*ADA019160 BBN Report No. 1822, "Specifications for the Interconnection of a Host and an IMP", revision of January 1976.
- AD730725 BBN Report No. 2161, "A Study of the ARPA Network Design and Performance", Kahn and Crowther, August 1971.
- \*ADA014398 BBN Report No. 2183, "Terminal Interface Message Processor - User's Guide," updated version of August 1975.
- \*ADA002481 BBN Report No. 2184, "TIP Hardware Manual," revision of November 1974.
- \*AD776995 BBN Report No. 2277, "Specifications for the Interconnection of Terminals and the Terminal IMP," Rettberg, revision of June 1973.
- BBN Report No. 2491, "Throughput in the ARPA Network -- Analysis and Measurement," McQuillan, January 1973 (text also contained in QTR No. 16, January 1973).
- ADA025358 BBN Technical Information Report (TIR) No. 89, "The Interface Message Processor Program," updated version of June 1976 (Version 3231).
- ADA033351 BBN TIR No. 90, "The Network Control Center Program," updated version of November 1976 (Version 131).
- ADA031617 BBN TIR No. 91, "The Terminal Interface Message Processor Program," updated version of August 1976 (Version 400).
- AD781467 BBN Report No. 2831, "Adaptive Routing Algorithms for Distributed Computer Networks," McQuillan, May 1974.

BBN TIR No. 93, "The Remote Job Entry Mini-Host," August 1974 (text also contained in QTR No. 6, July 1974).

BBN Report No. 2891, "A Proposed Experiment in Packet Broadcast Satellite Communications," Rettberg and Walden, September 1974.

BBN Report No. 2918, "Network Design Issues," November 1974 (text also contained in QTR No. 7, October 1974).

ADA022040 BBN Report No. 2999, "Pluribus Document 1: Overview," May 1975.

BBN Report No. 2930, "Pluribus Document 2: System Handbook," January 1975.

BBN Report No. 3000, "Pluribus Document 3: Configurator," in production.

BBN Report No. 3001, "Pluribus Document 4: Basic Software," December 1975.

BBN Report No. 2931, "Pluribus Document 5: Advanced Software," April 1975.

BBN Report No. 3002, "Pluribus Document 6: Functional Specifications," February 1976.

BBN Report No. 3004, "Pluribus Document 7: Maintenance," September 1976.

BBN Report No. 3056, "The Atlantic Satellite Packet Broadcast and Gateway Experiments," R. Binder, R. Rettberg, and D. Walden, April 1975.

ADA018341 BBN Report No. 3126, "A Multiprocessor Design," W. Barker, September 1975.



## A.2 Published Papers\*

W. Teitleman and R.E. Kahn, "A Network Simulation and Display Program," Proceedings of the Third Annual Princeton Conference on Information Sciences and Systems, March 1969.

F.E. Heart, R.E. Kahn, S.M. Ornstein, W.R. Crowther, and D.C. Walden, "The Interface Message Processor for the ARPA Computer Network," AFIPS Conference Proceedings 36, June 1970, pp. 551-567; also in Advances in Computer Communications, W.W. Chu (ed.), Artech House Inc., 1974, pp. 300-316; also in Computer Communications, P.E. Green and R.W. Lucky (eds.), IEEE Press, 1975, pp. 375-391; also in Computer Networking, R.P. Blanc and I.W. Cotton (eds.), IEEE Press, 1976, pp. 60-76.

F.E. Heart and S.M. Ornstein, "Software and Logic Design Interaction in Computer Networks," International Computer State of the Art Report No. 6: Computer Networks, Infotech Information Ltd., Maidenhead, Berkshire, England, pp. #23-462.

R.E. Kahn, "Terminal Access to the ARPA Computer Network," in Courant Computer Science Symposium 3 -- Computer Networks, R. Rustin (ed.), Prentice-Hall, Englewood Cliffs, N.J., 1972, pp. 147-166.

R.E. Kahn and W.R. Crowther, "Flow Control in a Resource-Sharing Computer Network," Proceedings of the Second ACM/IEEE Symposium on Problems in the Optimization of Data Communications Systems, Palo Alto, California, October 1971, pp. 108-116; also in IEEE Transactions on Communications, Vol. COM-20, No. 3, Part II, June 1972, pp. 539-546; also in Advances in Computer Communications, W.W. Chu (ed.), Artech House Inc., 1974, pp. 230-237; also in Computer Networking, R.P. Blanc and I.W. Cotton (eds.), IEEE Press, 1976, pp. 117-125.

D.C. Walden, "A System for Interprocess Communication in a Resource-Sharing Computer Network," Communications of the ACM, Vol. 15, No. 4, April 1972, pp. 221-230; also in Advances in Computer Communications, W.W. Chu (ed.), Artech House Inc., 1974, pp. 340-349.

-----  
\* Ordered according to date of writing.

R.H. Thomas and D.A. Henderson, "McROSS -- A Multi-Computer Programming System," AFIPS Conference Proceedings, Vol. 40, June 1972, pp. 281-293; also in Computer Networking, R.P. Blanc and I.W. Cotton (eds.), IEEE Press, 1976, pp. 246-258.

S.M. Ornstein, F.E. Heart, W.R. Crowther, S.B. Russell, H.K. Rising, and A. Michel, "The Terminal IMP for the ARPA Computer Network," AFIPS Conference Proceedings 40, June 1972, pp. 243-254; also in Advances in Computer Communications, W.W. Chu (ed.), Artech House Inc., 1974, pp. 317-328; also in Computer Communications, P.E. Green and R.W. Lucky (eds.), IEEE Press, 1975, pp. 354-365.

H. Frank\*, R.E. Kahn, and L. Kleinrock\*\*, "Computer Communications Network Design -- Experience with Theory and Practice," AFIPS Conference Proceedings, Vol. 40, June 1972, pp. 255-270; also in Networks, Vol. 2, No. 2, 1972, pp. 135-166; also in Advances in Computer Communications, W.W. Chu (ed.), Artech House Inc., 1974, pp. 254-269.

A.A. McKenzie, B.P. Cosell, J.M. McQuillan, and M.J. Thrope, "The Network Control Center for the ARPA Network," Proceedings of the First International Conference on Computer Communication, Washington, D.C., October 1972, pp. 185-191; also in Computer Networking, R.P. Blanc and I.W. Cotton (eds.), IEEE Press, 1976, pp. 319-325.

R.E. Kahn, "Resource-Sharing Computer Communications Networks," Proceedings of the IEEE, Vol. 60, No. 11, November 1972, pp. 1397-1407; also in Advances in Computer Communications, W.W. Chu (ed.), Artech House Inc., 1974, pp. 208-218; also in Computer Communications, P.E. Green and R.W. Lucky (eds.), IEEE Press, 1975, pp. 537-547.

J.M. McQuillan, W.R. Crowther, B.P. Cosell, D.C. Walden, and F.E. Heart, "Improvements in the Design and Performance of the ARPA Network," AFIPS Conference Proceedings 41, December 1972, pp. 741-754.

-----  
\*Network Analysis Corporation.

\*\*University of California at Los Angeles.

W.R. Crowther, R.D. Rettberg, D.C. Walden, S.M. Ornstein, and F.E. Heart, "A System for Broadcast Communication: Reservation-ALOHA," Proceedings of the Sixth Hawaii International Conference on System Sciences, January 1973, pp. 371-374.

D.C. Walden, "Host-to-Host Protocols," International Computer State of the Art Report No. 24: Network Systems and Software, Infotech, Maidenhead, England, pp. 287-316.

N.W. Mimno, B.P. Cosell, D.C. Walden, S.C. Butterfield, and J.B. Levin, "Terminal Access to the ARPA Network -- Experience and Improvements," Proceedings of the Seventh Annual IEEE Computer Society International Conference, San Francisco, California, February 1973, pp. 39-43; also in Computer Networking, R.P. Blanc and I.W. Cotton (eds.), IEEE Press, 1976, pp. 287-291.

E.W. Wolf, "An Advanced Computer Communication Network," AIAA Computer Network Systems Conference, April 1973, AIAA Paper No. 73-414.

F.E. Heart, S.M. Ornstein, W.R. Crowther, and W.B. Barker, "A New Minicomputer/Multiprocessor for the ARPA Network," AFIPS Conference Proceedings 42, June 1973, pp. 529-537; also in Advances in Computer Communications, W.W. Chu (ed.), Artech House Inc., 1974, pp. 329-337; also in Computer Communication Networks, R.L. Grimsdale and F.F. Kuo (eds.), Proceedings of the NATO Advanced Study Institute of September 1973, Sussex, England, published by Noordhoff International Publishing, Leyden, The Netherlands, 1975, pp. 159-180; also in Computer Communications, P.E. Green and R.W. Lucky (eds.), IEEE Press, 1975, pp. 366-374.

R.H. Thomas, "A Resource Sharing Executive for the ARPANET," AFIPS Conference Proceedings 42, June 1973, pp. 155-163; also in Advances in Computer Communications, W.W. Chu (ed.), Artech House Inc., 1974, pp. 359-367.

F.E. Heart, "The ARPA Network," in Computer Communication Networks, R.L. Grimsdale and F.F. Kuo (eds.), Proceedings of the NATO Advanced Study Institute of September 1973, Sussex, England, published by Noordhoff International Publishing, Leyden, The Netherlands, 1975, pp. 19-33.

W.R. Crowther, J.M. McQuillan, and D.C. Walden, "Reliability Issues in the ARPA Network," Proceedings of the ACM/IEEE Third Data Communications Symposium, November 1973, pp. 159-160; also in Computer Networking, R.P. Blanc and I.W. Cotton (eds.), IEEE Press, 1976, pp. 142-143.

J.M. McQuillan, "Design Considerations for Routing Algorithms in Computer Networks," Proceedings of the Seventh Annual Hawaii International Conference on System Sciences, Honolulu, Hawaii, January 1974, pp. 22-24; also in Computer Networking, R.P. Blanc and I.W. Cotton (eds.), IEEE Press, 1976, pp. 108-110.

S.M. Ornstein, W.B. Barker, R.D. Bressler, W.R. Crowther, F.E. Heart, M.F. Kraley, A. Michel, and M.J. Thrope, "The BBN Multiprocessor," Proceedings of the Seventh Annual Hawaii International Conference on System Sciences, Honolulu, Hawaii, January 1974, Computer Nets Supplement, pp. 92-95.

A.A. McKenzie, "Some Computer Network Interconnection Issues," AFIPS Conference Proceedings 43, May 1974, pp. 857-859.

E.A. Akkoyunlu\*, A.J. Bernstein\*, and R.E. Schantz, "Interprocess Communication Facilities for Network Operating Systems," IEEE Computer, Vol. 7, No. 6, June 1974, pp. 46-55.

F.E. Heart, "Implications of the Computer-Communication Partnership," in Preprints of Papers, MEDINFO 74: The First World Conference on Medical Informatics, Stockholm, Sweden, August 1974, pp. 21-27; proceedings to be published by North-Holland, The Netherlands.

F.E. Heart, "Networks and the Life Sciences: the ARPA Network and Telenet," Federation Proceedings, Federation of American Societies for Experimental Biology (FASEB), Vol. 33, No. 12, December 1974, pp. 2399-2402; also in Computers in Life Science Research, W. Siler and D.A.B. Lindberg (eds), FASEB and Plenum Press, 1975, pp. 209-215.

J.M. McQuillan, "The Evolution of Message Processing Techniques in the ARPA Network," International Computer State of the Art Report No. 24: Network Systems and Software, Infotech, Maidenhead, England, pp. 541-578.

R.H. Thomas, "JSYS Traps - A TENEX Mechanism for Encapsulation of User Processes," AFIPS Conference Proceedings 44, May 1975, pp. 351-360.

-----  
\*State University of New York at Stony Brook.

S.M. Ornstein, W.R. Crowther, M.F. Kraley, R.D. Bressler, A. Michel, and F.E. Heart, "Pluribus -- A Reliable Multiprocessor," AFIPS Conference Proceedings 44, May 1975, pp. 551-559.

F.E. Heart, S.M. Ornstein, W.R. Crowther, W.B. Barker, M.F. Kraley, R.D. Bressler, and A. Michel, "The Pluribus Multiprocessor System." in Multiprocessor Systems: Infotech State of the Art Report, Infotech International Ltd., Maidenhead, Berkshire, England, 1976, pp. 307-330.

W.R. Crowther, F.E. Heart, A.A. McKenzie, J.M. McQuillan, and D.C. Walden, "Issues in Packet-Switching Network Design," AFIPS Conference Proceedings 44, May 1975, pp. 161-175; also in Computer Networking, R.P. Blanc and I.W. Cotton (eds.), IEEE Press, 1976, pp. 182-196.

R.S. Tomlinson, "Selecting Sequence Numbers," Proceedings of the ACM SIGCOMM-SIGOPS Interface Workshop on Interprocess Communications, March 1975, pp. 11-23.

J.M. McQuillan and D.C. Walden, "Some Considerations for a High Performance Message-Based Interprocess Communication System," Proceedings of the ACM SIGCOMM-SIGOPS Interface Workshop on Interprocess Communications, March 1975, pp. 77-86.

S.M. Ornstein and D.C. Walden, "The Evolution of a High Performance Modular Packet-Switch," Conference Record of the 1975 International Conference on Communications, June 1975, Vol. I, pp. 6-17 to 6-21.

R.D. Bressler, M.F. Kraley, and A. Michel, "Pluribus: a Multiprocessor for Communications Networks," Fourteenth Annual ACM/NBS Technical Symposium -- Computing in the mid-70's: an Assessment, June 1975, pp. 13-19.

D.C. Walden, "Experiences in Building, Operating, and Using the ARPA Network," Proceedings of the 2nd USA-Japan Computer Conference, Tokyo, Japan, August 1975, pp. 453-458.

R.D. Rettberg and D.C. Walden, "Gateway Design for Computer Network Interconnection," in: Communications Networks: Proceedings of the European Computing Conference on Communications Networks, London, England, September 1975, published by Online Conferences Limited, Uxbridge, England, pp. 113-128.

M.F. Kraley, "The Pluribus Multiprocessor," Digest of the 1975 International Symposium on Fault-Tolerant Computing, Paris, France, June 18-20, 1975, p. 251 (abstract only).

B.P. Cosell, J.M. McQuillan, and D.C. Walden, "Techniques for Detecting and Preventing Multiprogramming Bugs," in: Minicomputer Software, J.R. Bell and C.G. Bell (eds.), North-Holland Publishing Co., 1976, pp. 301-308.

A.A. McKenzie, "The ARPA Network Control Center," Proceedings of the Fourth ACM Data Communications Symposium, Quebec City, Canada, October 1975, pp. 5-1 to 5-6.

B.P. Cosell, P.R. Johnson, J.H. Malman, R.E. Schantz, J. Sussman, R.H. Thomas, and D.C. Walden, "An Operational System for Computer Resource Sharing," Proceedings of the Fifth Symposium on Operating System Principles, Austin, Texas, November 1975, pp. 75-81.

R.D. Bressler and R.H. Thomas, "Design Issues in Distributed Computing," in Distributed Systems: Infotech State of the Art Report, Infotech International Ltd., Maidenhead, Berkshire, England, 1976, pp. 215-222.

V. Cerf\*, A. McKenzie, R. Scantlebury\*\*, and H. Zimmermann\*\*\*, "Proposal for an International End to End Protocol," ACM Computer Communication Review, Vol. 6, No. 1, January 1976, pp. 63-89.

W.F. Mann, S.M. Ornstein, and M.F. Kraley, "A Network-Oriented Multiprocessor Front-End Handling Many Hosts and Hundreds of Terminals", AFIPS Conference Proceedings 45, June 1976, pp. 533-540.

P.J. Santos, "Software Instrumentation for Maintainability of Distributed Computer Networks," Fifteenth Annual ACM/NBS Technical Symposium--Directions and Challenges, June 1976, pp. 143-148.

J.M. McQuillan, "A Status Report on the ARPANET," Australian Computer Society/International Federation for Information Processing Joint International Symposium on Data Communications Technology and Practice, August 1976, pp. 13.1-13.7.

-----  
\*Defense Advanced Research Projects Agency

\*\*Institut de Recherche d'Informatique et d'Automatique (France)

\*\*\*National Physical Laboratories (U.K.)

J.M. McQuillan, "Strategies for Implementation of Multi-Host Computer Networks," ACS/IFIP Joint International Symposium on Data Communications Technology and Practice, August 1976, pp. 26.1-26.6; also in Computer Communication Review, Vol. 6, No. 4, October 1976, pp. 19-24.

F.E. Heart and D.C. Walden, "Communications Applications of the Pluribus Computer," Conference Record of the 1976 IEEE National Telecommunications Conference, Dallas, Texas, 29 November-1 December 1976, pp. 7.1-1 to 7.1-5.

R. Levin\*, J.M. McQuillan, and R. Schantz, "Distributed Systems," a section of "New Directions for Operating Systems: A Workshop Report," J.C. Browne, Operating Systems Review, Vol. 11, No. 1, January 1977, pp. 14-19.

J.M. McQuillan and D.C. Walden, "Issues in Packet Switching Network Design and the ARPANET Design Decisions," submitted to Computer Networks.

J. Davidson, W. Hathaway\*, N. Mimno, J. Postel\*\*, R. Thomas, and D. Walden, "The ARPANET TELNET Protocol: Its Purpose, Principles, Implementation, and Impact on Host Operating System Design," submitted for presentation at the ACM/IEEE Fifth Data Communications Symposium, Snowbird, Utah, September 27-29, 1977.

-----  
\*Carnegie-Mellon University  
\*NASA Ames Research Center  
\*\*USC Information Sciences Institute

B. Selection of ARPANET Logical Maps

The following logical maps of the ARPANET are included:

December 1970  
April 1971  
August 1971  
March 1972  
August 1972  
September 1973  
June 1974  
November 1974  
January 1975  
June 1975  
October 1975  
July 1976  
October 1976  
January 1977  
March 1977



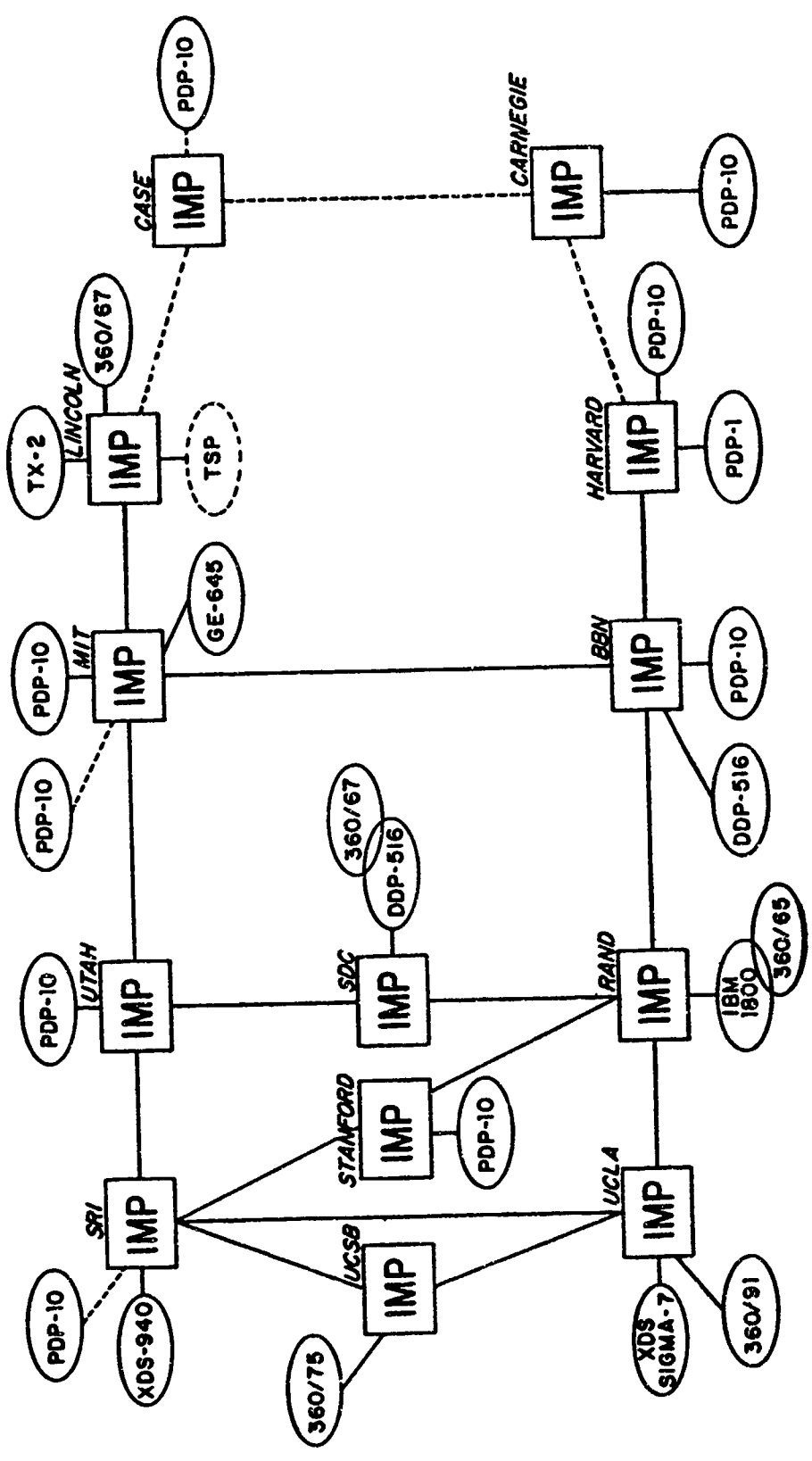

ARPA NET, DECEMBER 1970

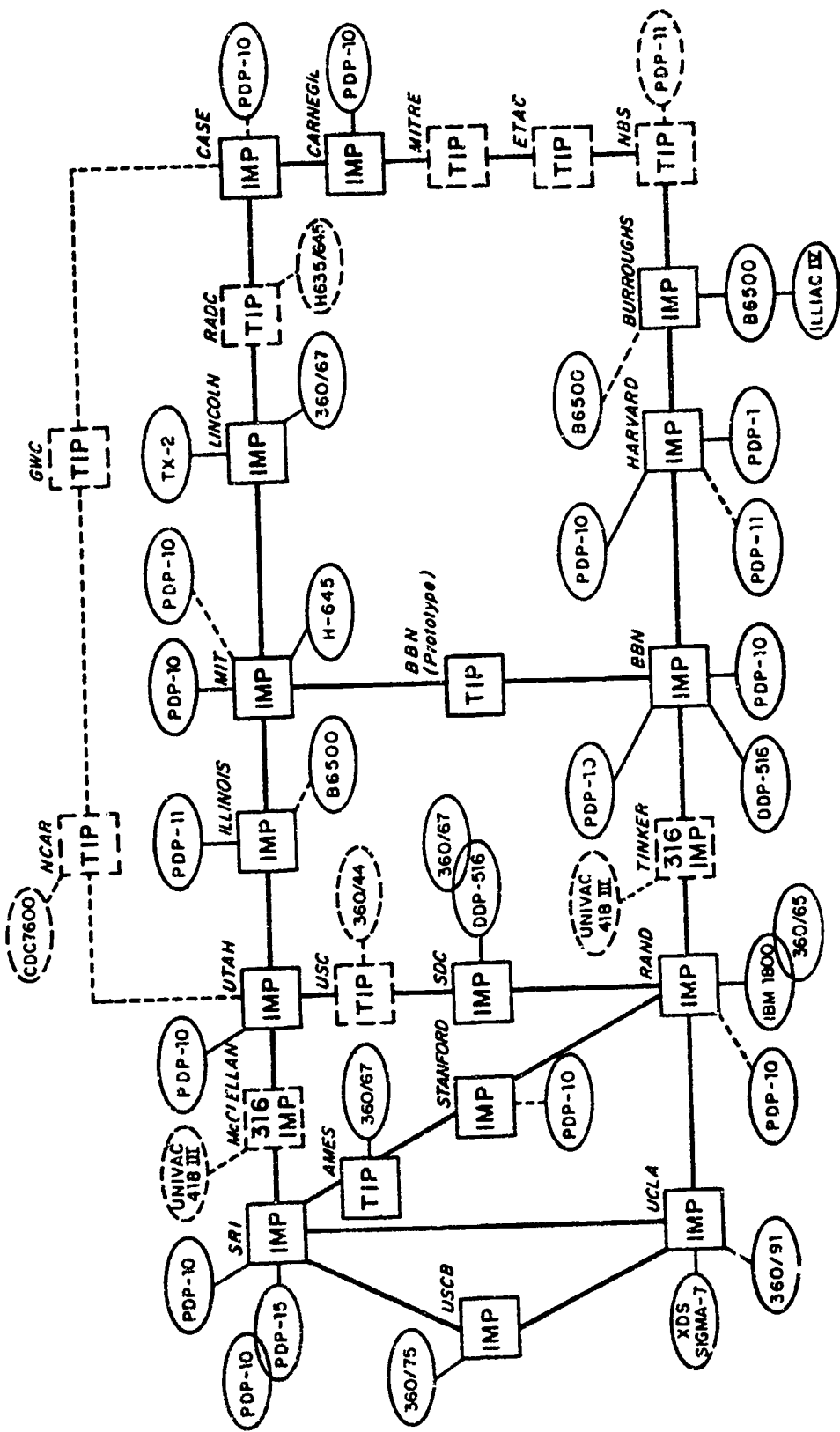

ARPA NET, AUGUST 1971

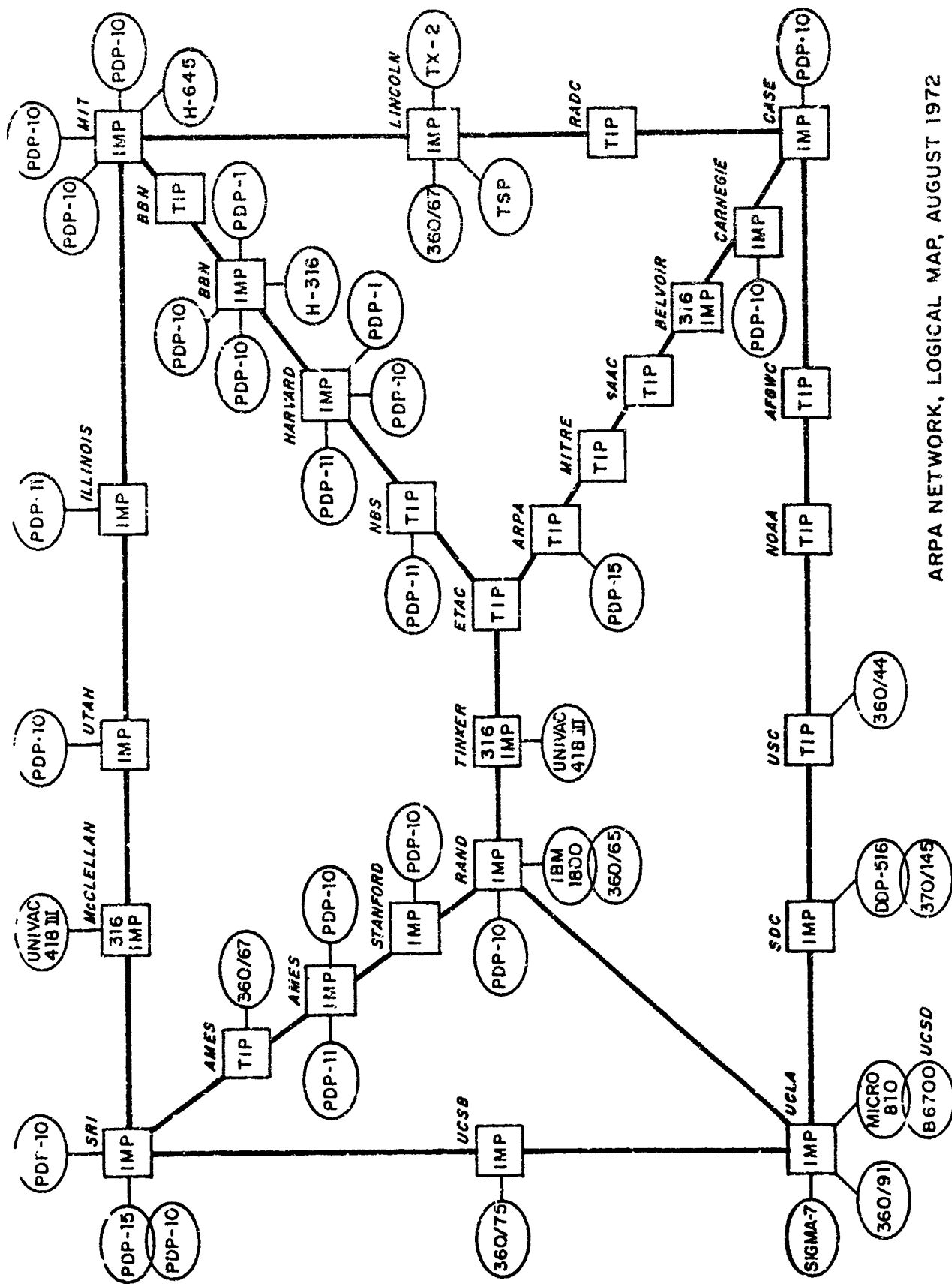

ARPA NETWORK, LOGICAL MAP, AUGUST 1972

# ARPA NETWORK, LOGICAL MAP, JANUARY 1975

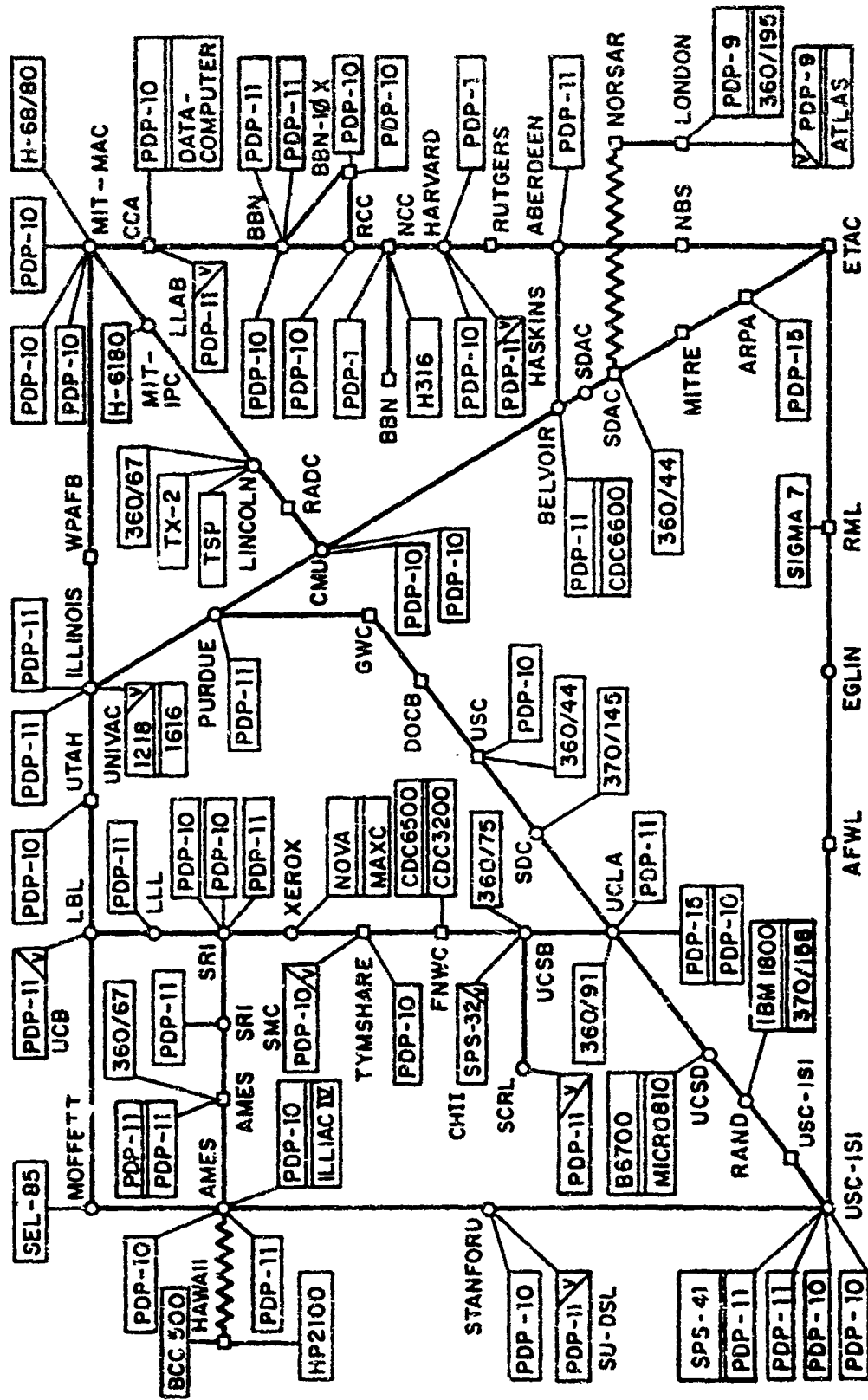

○ IMP  
 □ TIP

ARPA NETWORK, LOGICAL MAP, OCTOBER 1, 1975

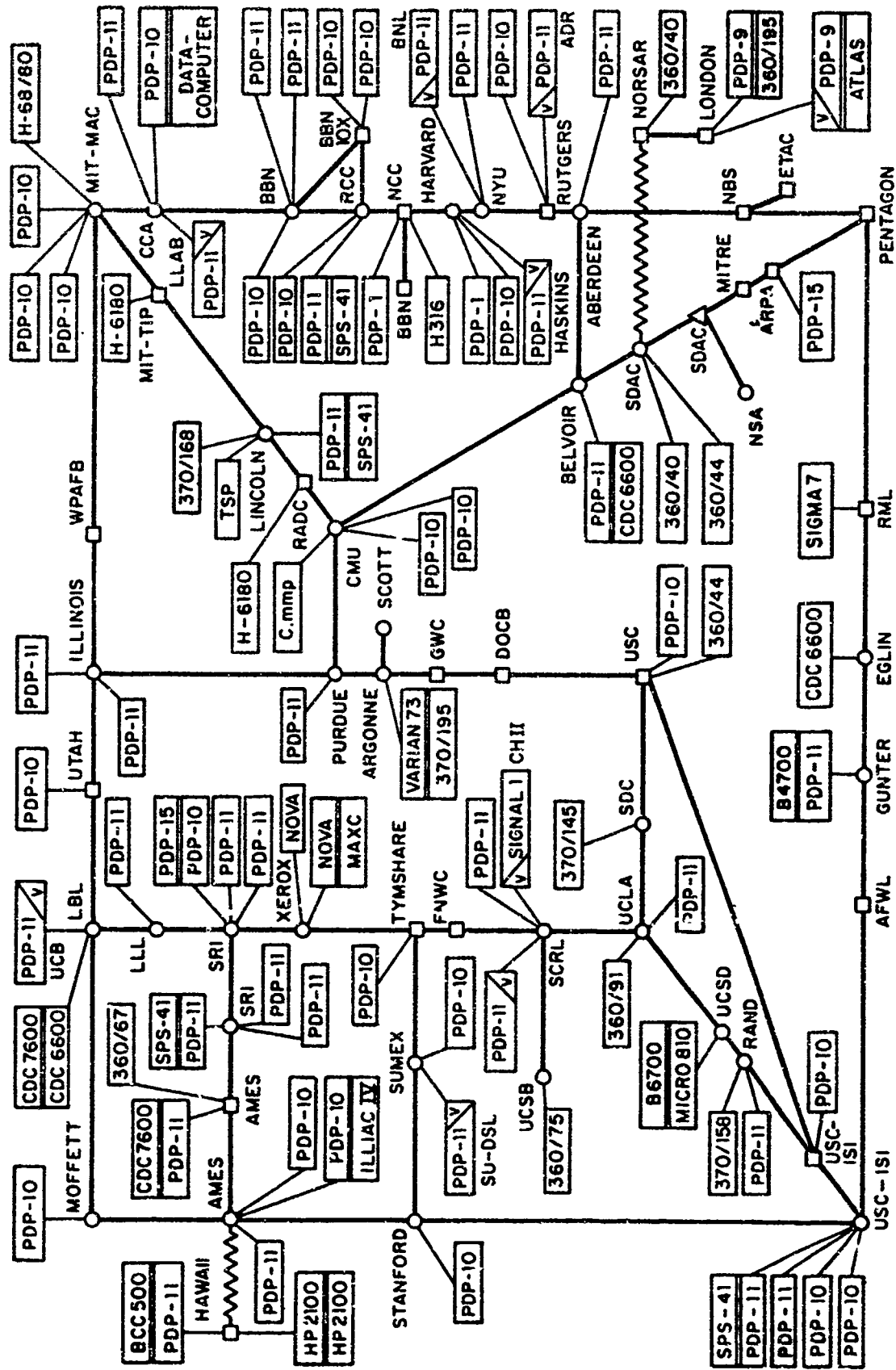

○ IMP  
 □ TIP  
 △ PLURIBUS IMP

# ARPANET LOGICAL MAP, OCTOBER 1976

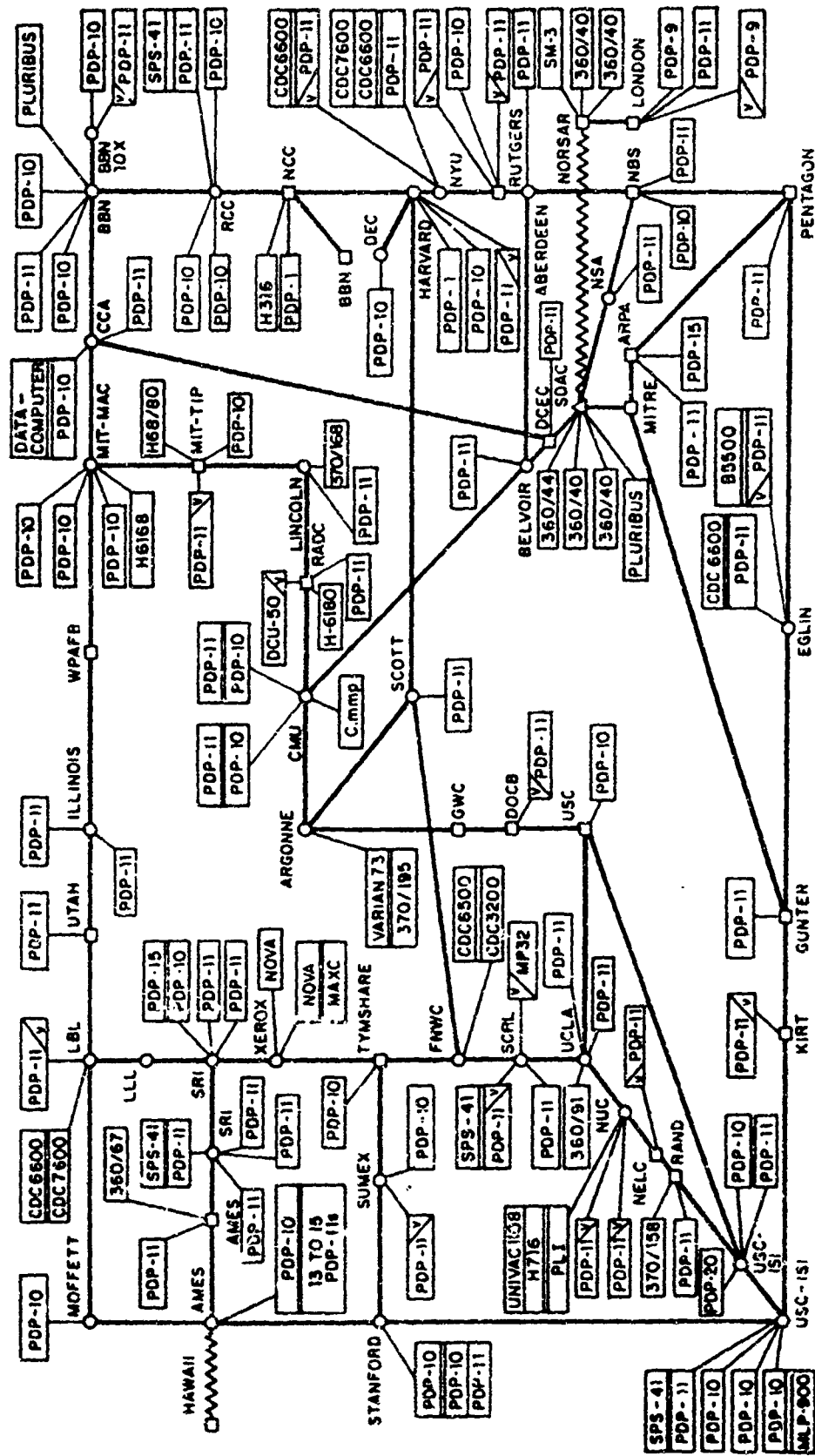

(PLEASE NOTE THAT WHILE THIS MAP SHOWS THE HOST POPULATION OF THE NETWORK ACCORDING TO THE BEST INFORMATION OBTAINABLE, NO CLAIM CAN BE MADE FOR ITS ACCURACY)

# ARPANET LOGICAL MAP, MARCH 1977

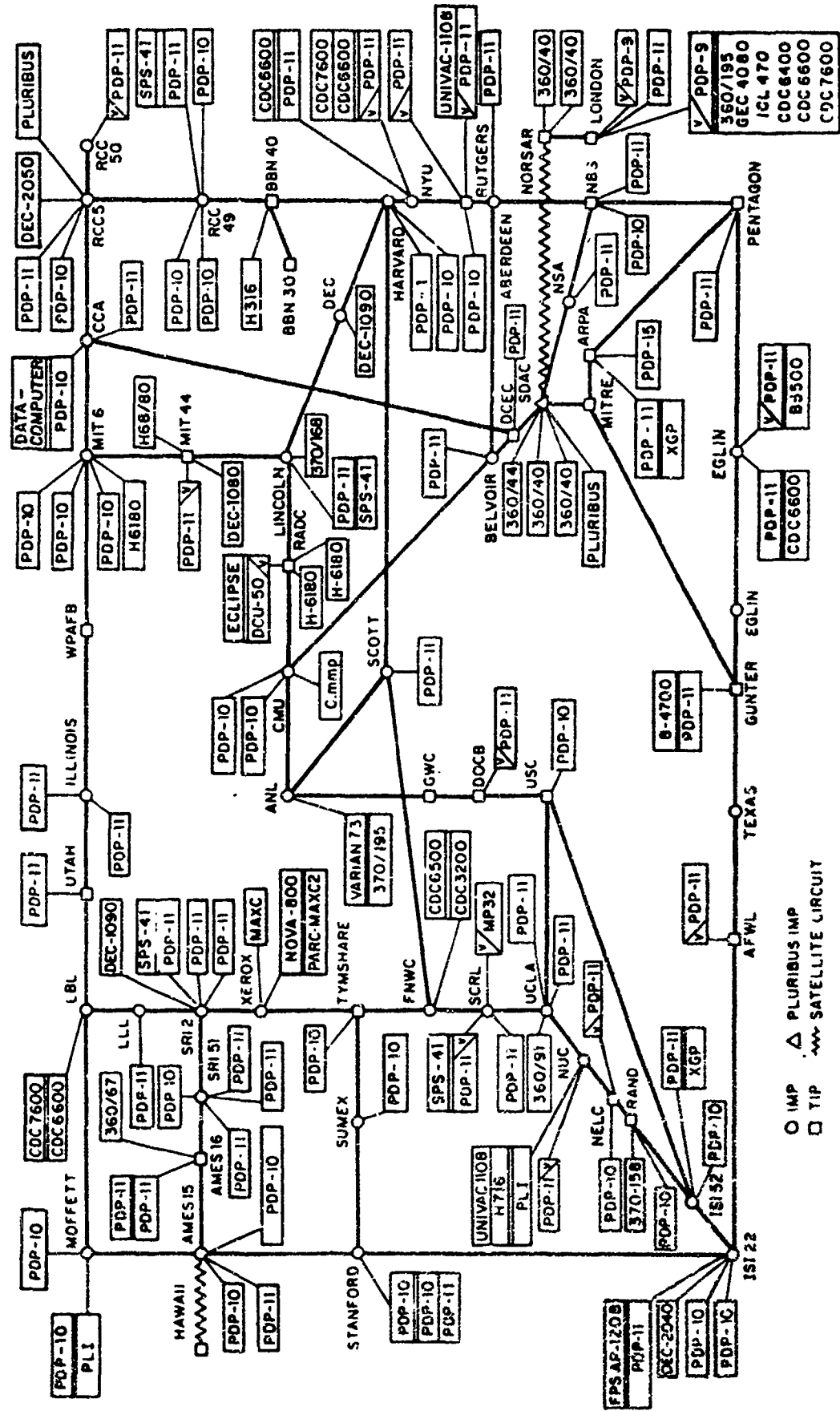

○ IMP  
 △ PLURIBUS IMP  
 □ TIP  
 ~~~~~ SATELLITE CIRCUIT

(PLEASE NOTE THAT WHILE THIS MAP SHOWS THE HOST POPULATION OF THE NETWORK ACCORDING TO THE BEST INFORMATION OBTAINABLE, NO CLAIM CAN BE MADE FOR ITS ACCURACY)  
 NAMES SHOWN ARE IMP NAMES, NOT (NECESSARILY) HOST NAMES