

DETERMINISTIC ETHERNET

IEEE 802.1 standards for real-time process control, industrial automation, and vehicular networks

Contents

- History, markets and use cases
 - Time synchronization on networks
 - Quality of Service
 - Shortest Path Bridging
 - Mixed-technology networking
-
- This presentation with animations is available at:
<http://www.ieee802.org/1/files/public/docs2012/tutorial-Deterministic-Ethernet-1112.ppt>

HISTORY, MARKETS AND USE CASES

Oliver Kleineberg

Belden / Hirschmann Automation & Control

History and Emerging Markets

- Early adopters outside IT: Industrial Automation (~1990s)
 - Higher Bandwidth than Fieldbusses
(legacy automation network technologies, e.g. Profibus, Interbus, ...)
 - Convergence with IT services
 - Widely available silicon could largely be re-used
 - Micro-Segmentation / Fully switched networks introduced first „deterministic Ethernet“
 - Easy fibre adoption

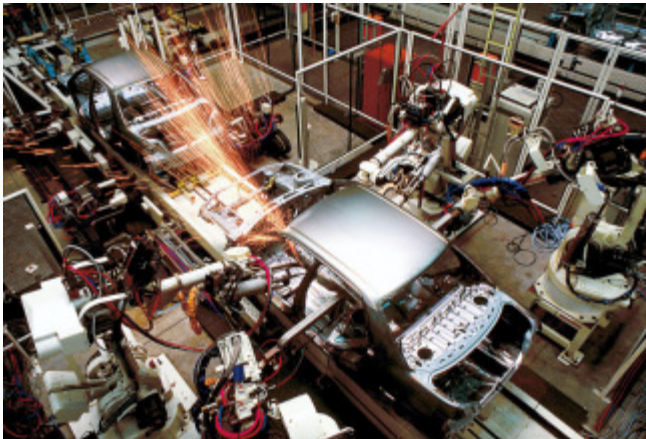

Manufacturing shop floor

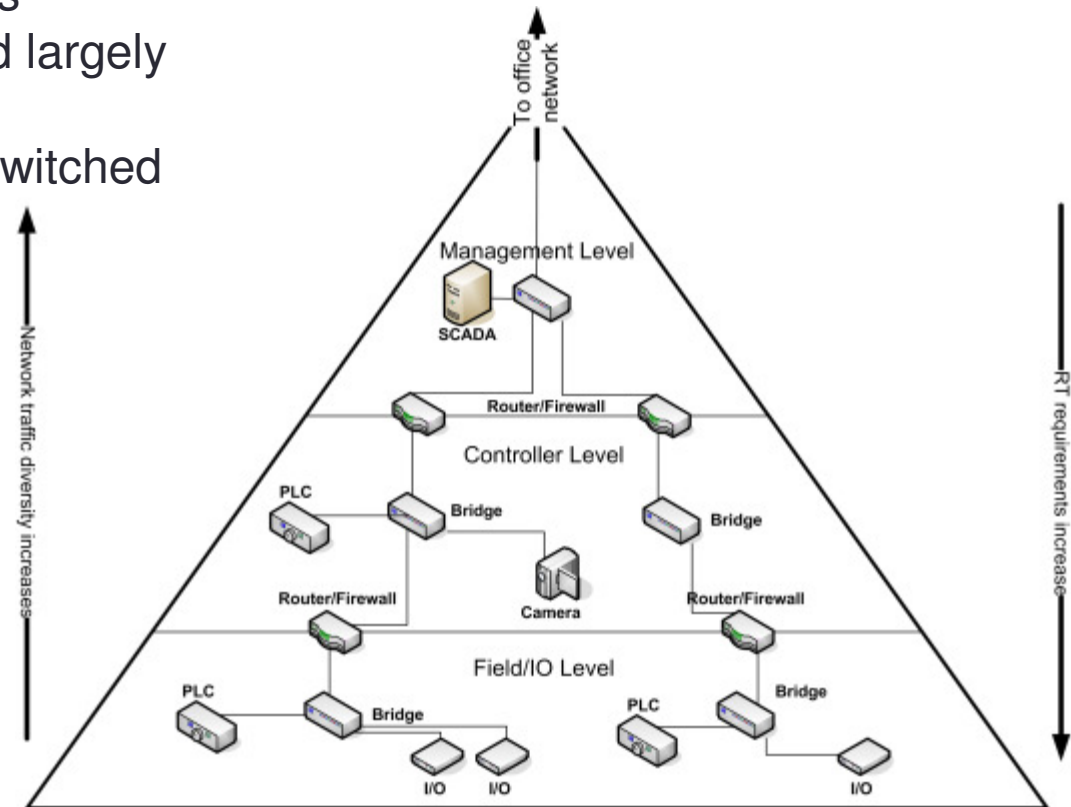

Automation Pyramid

History and Emerging Markets

- Early adopters outside IT: Professional and Home Audio and Video (early to mid 2000's)
 - High Performance
 - Good Price / Performance
 - High flexibility in wiring and media
 - Easily merges with existing home entertainment networks and Wireless LANs
 - In 2005, work in IEEE 802.3 (Residential Ethernet) started → Later moved to IEEE 802.1 as Audio and Video Bridging

Converged home networked services:

- File storage
- VoIP
- Audio and Video transmission (on demand)



Live Performances(*)



Home Theater PC(*)

History and Emerging Markets

- Existing Technologies: IEEE and Non-IEEE
 - IEEE 802.1 Audio and Video Bridging
 - Of high interest in Professional and Home Audio and Video
 - Time Synchronization based on well-proven IEEE 1588 protocol
 - Bandwidth Reservation and Class-based QoS (Traffic Shaping)
 - Deterministic Real-Time Ethernet technology that fits the original use case very well
 - Already applicable to some of the emerging new market applications
 - IEEE 802.1 Shortest Path Bridging
 - Providing resiliency to failures in the network infrastructure
 - Where no IEEE standards were available, other specifications emerged, often driven by proprietary technologies:
 - Proprietary protocols for Professional Audio (e.g. Cobranet)
 - Proprietary protocols for Industrial Automation (e.g. ISO/IEC addressing Redundancy and Real-Time in ISO/IEC 62439 / 61158 / 61784 series)
 - Application-specific extensions of standard IEEE 802 technologies (e.g. ARINC Avionics Full-Duplex Switched Ethernet - AFDX)
- High demand for a **converged IEEE 802 solution for deterministic Ethernet** to replace proprietary technology and fit the needs of existing and emerging markets.

History and Emerging Markets

- Emerging Markets: Mission-critical networking
 - Emerges out of Industrial Automation, massively broadening the scope
 - Requirements (far) beyond standard IT equipment relating to determinism in time and protocol behaviour
 - Often used as transparent communication channel for End-to-End Safety Communication
 - Risk for Life and Limb if the system fails – High requirements to overall network, protocol and device robustness



Power Utility Automation



Traffic Control Systems



Transportation

...

Use Case: Mission-critical Automation

- Railway: Rolling stock



- Ethernet in trains has applications in customer information and also infotainment

- Another application area lies in train control networks and video surveillance...
- ...as well as passenger counters and detectors on the automatic train doors



Use Case: Motion Control



Wind turbine: Synchronized rotor blade control actuators



Printing machine: Large number of synchronized axles

Applications where robots and humans closely interact:

- Robot-assisted manufacturing
- Robot-assisted surgery
- Robotic prostheses
- ...



History and Emerging Markets

• Emerging Markets: Vehicular Networks

- Reduced Wiring Harness → Reduced weight and cabling costs
- Reduce overall costs by using standardized chips
- Reduce risks of binding to one silicon/solution vendor
- Unified solution for different application areas (e.g. Infotainment, Power Train, Driver Assistance, ...)

Infotainment and Connectivity

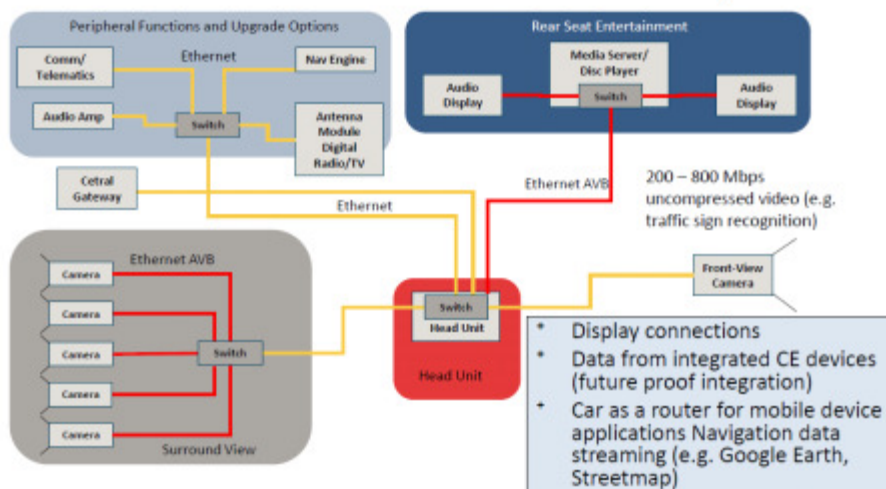

DAIMLER

Mercedes-Benz S-Class (2006) complete cable harness

- about 38kg, following slides show details of this harness (parts of some dedicated harnesses)

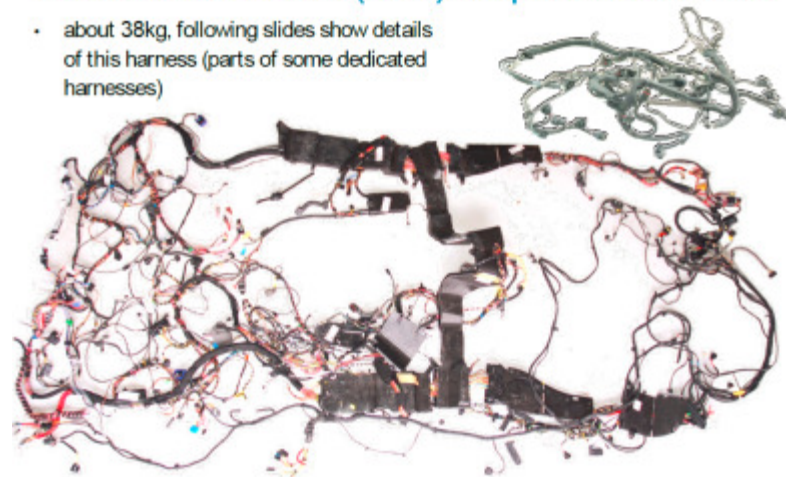

Use Case: Vehicular Network

- An example converged backbone network for the domain architecture

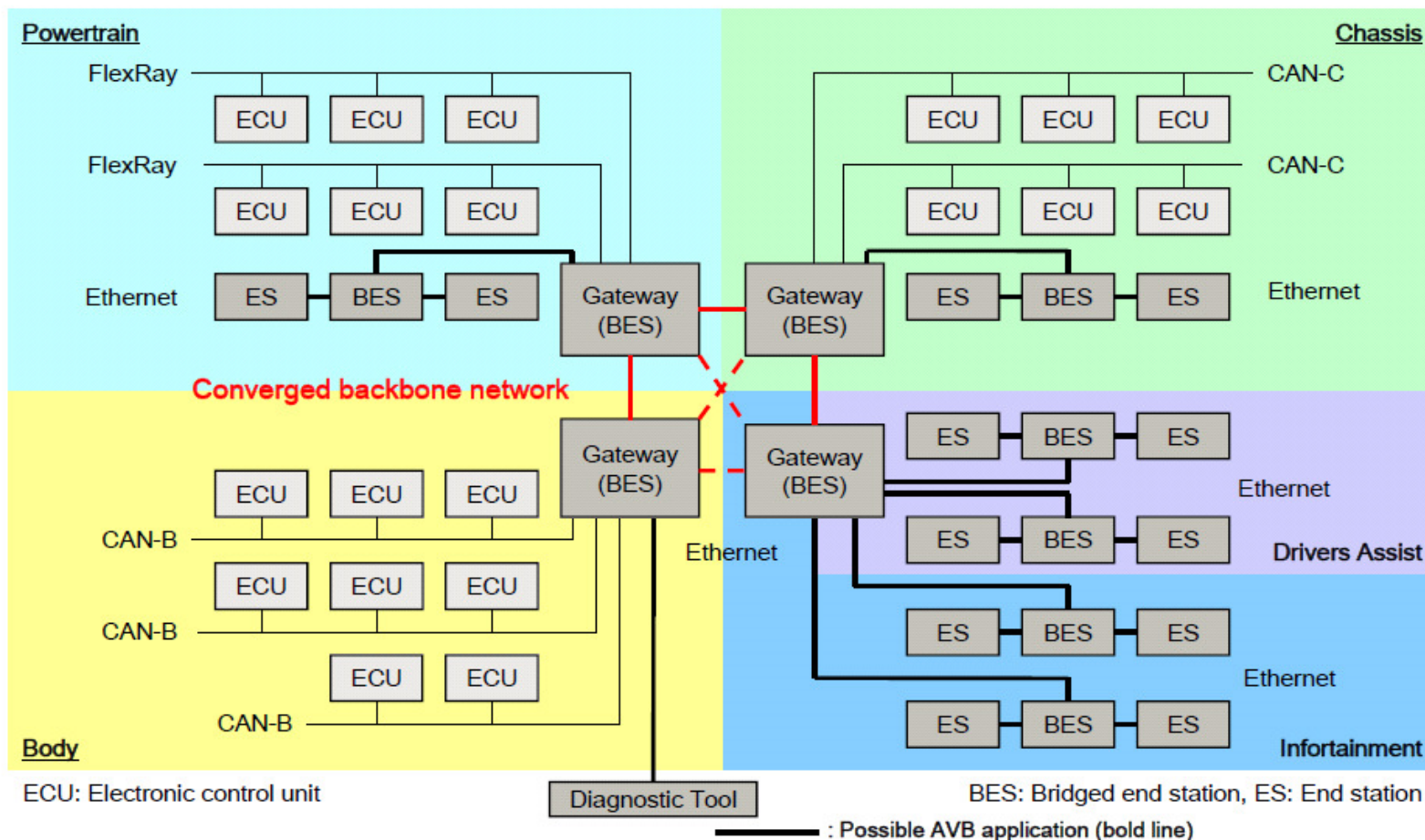

One possible application example of a future vehicular network

History and Emerging Markets

- One Step further - Added Requirements for a converged IEEE solution for Deterministic Ethernet:
 - There are many requirements already covered by 802.1 AVB and other IEEE 802 solutions, but the scope has broadened
 - Need to support larger network structures (long daisy-chains, interconnected rings...)
 - Very High EM resistance and low weight/cost of PHY's (see RTPGE)
 - Very low latency and jitter, exceeding the original AVB scope
 - Seamless fault-tolerance
 - Resilient Time Synchronization

802.1 and 802.3 are currently starting or have already started to address these market needs!

TIME SYNCHRONIZATION ON NETWORKS

Michael D. Johas Teener, Broadcom Corporation

Agenda

- Why do we care?
- Network time synch fundamentals
- IEEE 802.1AS
- What's next

Uses and Requirements

- Phase/frequency lock for Ethernet emulation of SDH/SONET architecture
 - must meet ITU specs
- Event coordination for control and testing
 - industrial / test & measurement
- Synchronization between multiple media streams
 - 1 microsecond max error in professional use
- Frequency base for time stamping of audio/video packets
 - less than 100 ps jitter for uncompressed HD video

This Is Not Easy

- IT networks were designed to carry as much information as possible as reliably as possible
 - Speed was important, efficiency was important, delay minimization was important
 - Maintaining synchronization was only a secondary concern (at best)
- All concept of “time” was lost in network specifications except for physical layers
 - Delays in buffers and queues were not communicated or measured.
 - There was no explicit way for an application to determine when an event occurred on a remote device without some kind of out-of-band support: WWV, GPS, 1PPS (one pulse per second) cable, IRIG, etc.

So, How Do We Do It?

- The key is the measurement of delay
 - ... which can be done via a packet exchange such as done in NTP (Network Time Protocol)

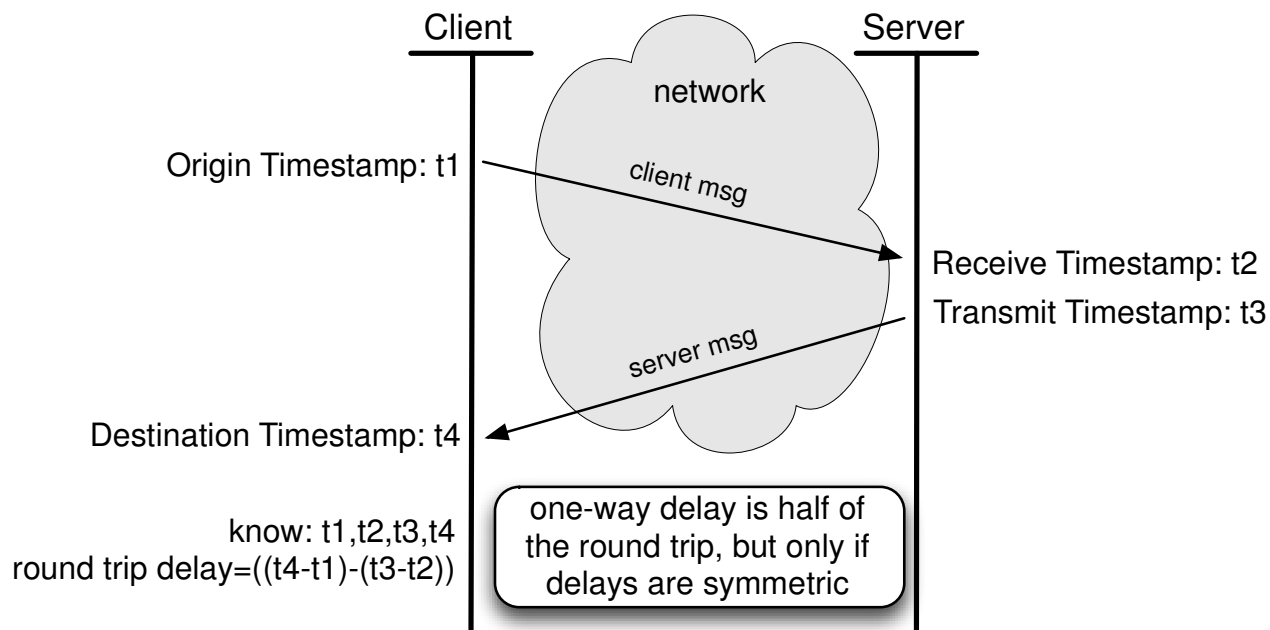

- A client can then use a time value transmitted by a server just by adding the delay

The Magic Is the Time Stamp

- A timestamp is the value of some timer when a particular event occurs
 - The more precise and deterministic the event, the better
 - In NTP, it's not well controlled ... usually a kernel/driver software event as close to the hardware as possible, only millisecond accuracy
 - To get better results, we use a physical layer event ... in Ethernet, that's the start of packet, sub microsecond accuracy
- By communicating the value of timestamps at well-known events, we can correlate network actions with actual time.

Precision Time Protocol (PTP)

- IEEE 1588 standardized the use of physical layer timestamps to compute network delays and define synchronization events
 - IEEE 802.1AS is a 1588 “profile” with fewer options, and extended physical layer options
- Components
 - Time Distribution
 - Link Delay Measurement
 - Best Master Clock Selection

Two Step Messaging

- How do we communicate the time of the start of a packet that is being transmitted?
 - Send that time in a later packet, the “follow up”, as the “precise origin timestamp”

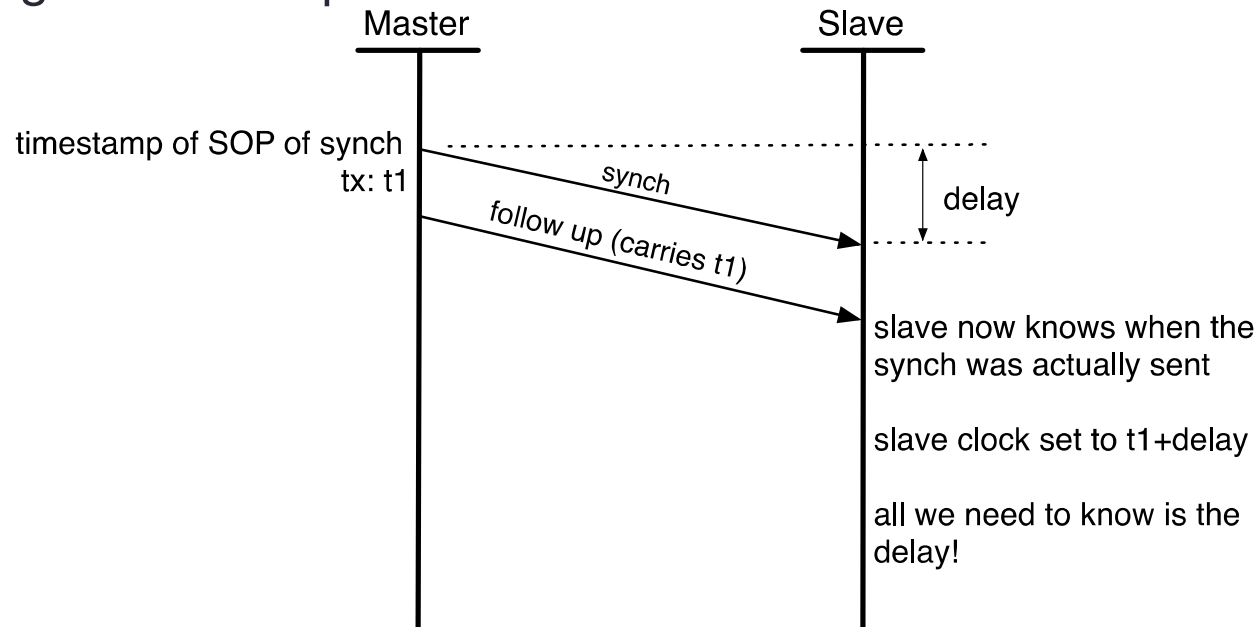

- It is possible to insert the timestamp into a transmit packet on the fly ... this is called “one step messaging” ...

Time Correction in a Bridge

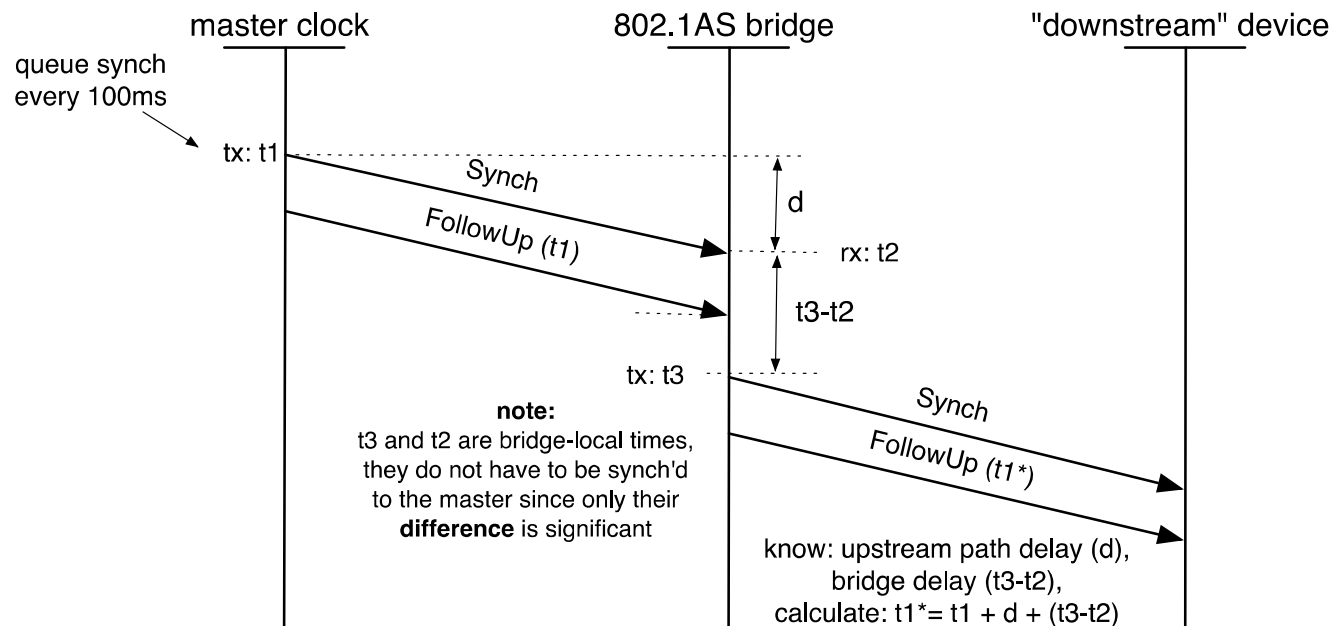

- Bridges Delays are now relatively constant, since they are just cable delays, without queues or buffers
 - 1588 calls this a “transparent clock”, required in 802.1AS
- A “correction field” in the FollowUp is incremented by the upstream delay and the residence time ($t3-t2$)
 - The correction field plus the precise origin timestamp plus the upstream delay is the correct time

Path Delay Processing

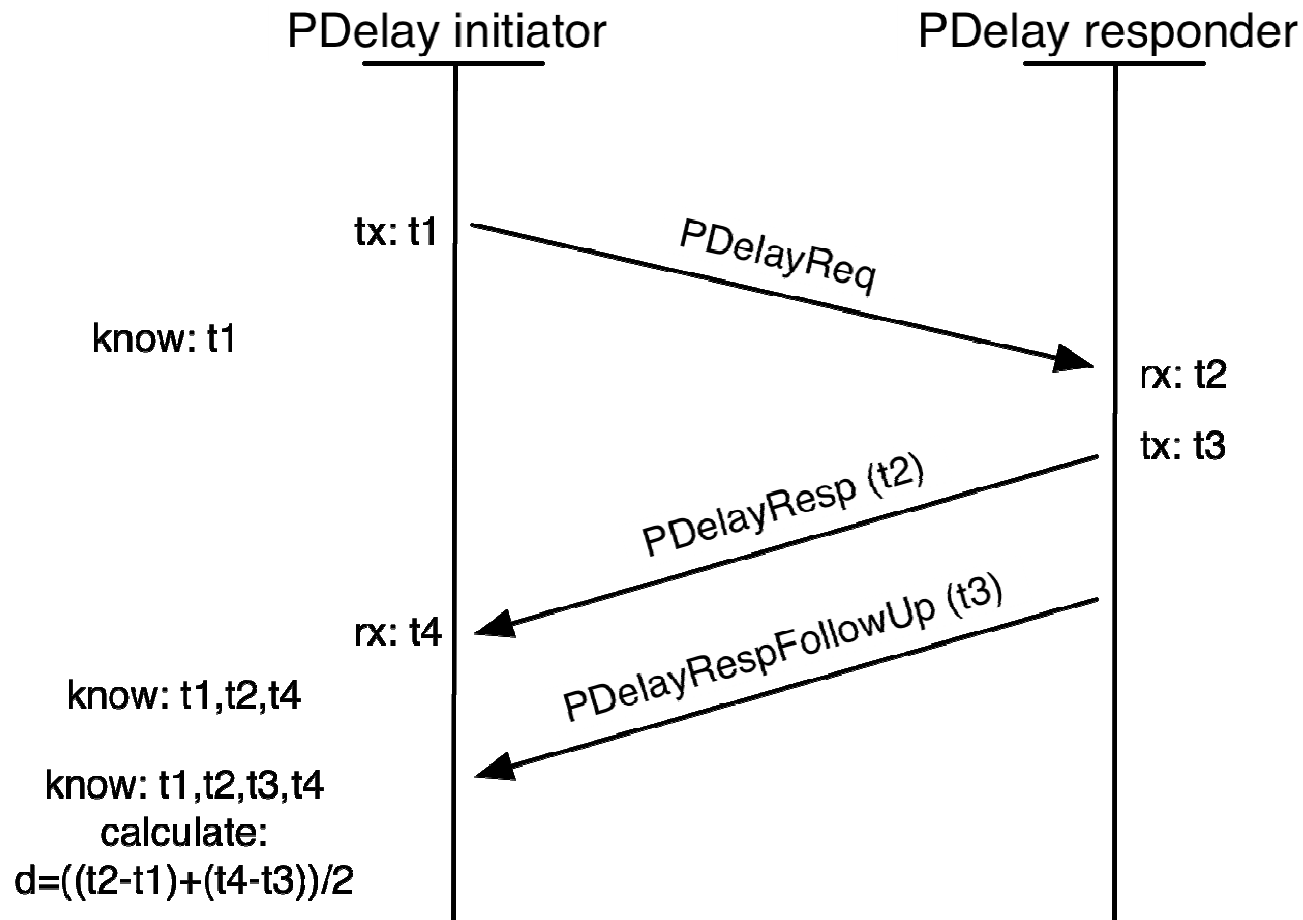

- Done infrequently since delays are stable

IEEE 802.1AS

- 802.1AS uses a subset and superset of IEEE 1588v2
 - Different methods for delay measurement for different L2 technologies
 - 802.3 (full duplex) is supported using a very specific profile of IEEE 1588
 - f802.3 (EPON), 802.11, and generalized CSN's (coordinated shared networks) are supported by new specifications
- Includes performance specifications for bridges as “time aware systems”
 - Uses accumulated “neighbor rate ratio” calculations to improve accuracy and speed up convergence
- Includes plug and play operation and startup
 - Requires use of a very specific form of BMCA (Best Master Clock Algorithm) that bridges also use

802.1AS Architecture

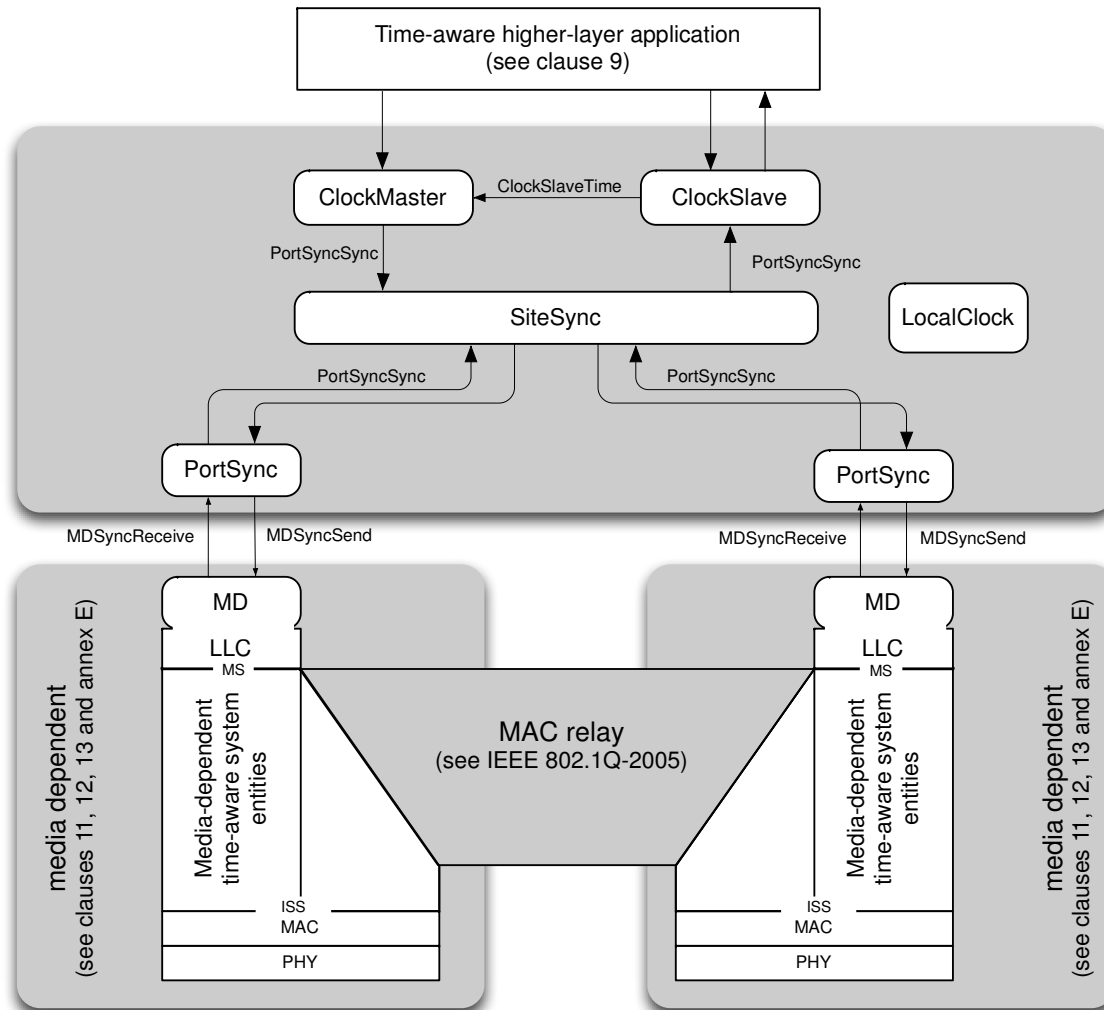

Best Master Clock Selection

- All bridges announce the quality of their clock to their neighbors
 - The best announcements are propagated
- Each bridge compares received announcements to their own clock quality
 - Quality is comprised of (in decreasing order of importance):
 - Priority (configurable)
 - Multiple “clock quality” fields
 - MAC address
- If “superior” announce messages are received
 - that bridge ceases to announce and adopts the superior bridge as the grand master
- If the grand master dies and announce messages cease
 - all bridges announce and a new grand master is quickly chosen

Next Steps (802.1ASbt)

- Explicit support for one-step processing
 - Backwards compatible to two-step
- Hot standby for backup GMs
- Multiple paths for clock propagation
- Clock path quality metric

QUALITY OF SERVICE

Christian Boiger

Deggendorf University of Applied Sciences

Quality of Service

- The requirements on traffic are very different for various applications and types of data
- For some applications it is enough to have strict priority transmission selection and low utilization
- But for some types of traffic with high QoS demands it is not enough to be sent before the lower priority traffic
- And some of these applications need guaranteed QoS (e.g. guaranteed very low latency)
- The “old” IEEE 802.1 QoS mechanisms did not provide guarantees

Guaranteed QoS

- An example for a type of traffic with high QoS requirements are audio/video streams
- Some applications need guaranteed low latency for this type of data
- The network needs low latency (latency = buffers)
- Audio Video Bridging addresses this problem
- One part of the solution to achieve the requirements of audio/video streams is the combination of:
 - Stream reservation (incl. bandwidth reservation)
 - Traffic shaping
- Both parts are necessary, in order to provide a latency guarantee for this type of traffic

Audio Video Bridging

- Audio Video Bridging (AVB) introduced new a type of traffic classes for audio/video streams
 - SR class A
 - SR class B
- SR class A traffic has the highest priority in the network
- The major goals of the AVB QoS features are to:
 - Protect the best effort traffic from the SR class traffic
 - Protect the SR class traffic from best effort traffic
 - Protect the SR class traffic from itself
- Both AVB QoS mechanisms (stream reservation and traffic shaping) address these goals

Stream Reservation

- The Stream Reservation Protocol (SRP):
 - Advertises streams in the whole network
 - Registers the path of streams
 - Calculates the “worst case latency”
 - Specifies the forwarding rules for AVB streams
 - Establishes an AVB domain
 - Reserves the bandwidth for AVB streams
- Especially the bandwidth reservation is important in order to:
 - Protect the best effort traffic, as only 75% of the bandwidth can be reserved for SR class traffic
 - Protect the SR class traffic as it is not possible to use more bandwidth for SR class traffic than 75% (this is an important factor in order to guarantee a certain latency)

Stream Reservation Example

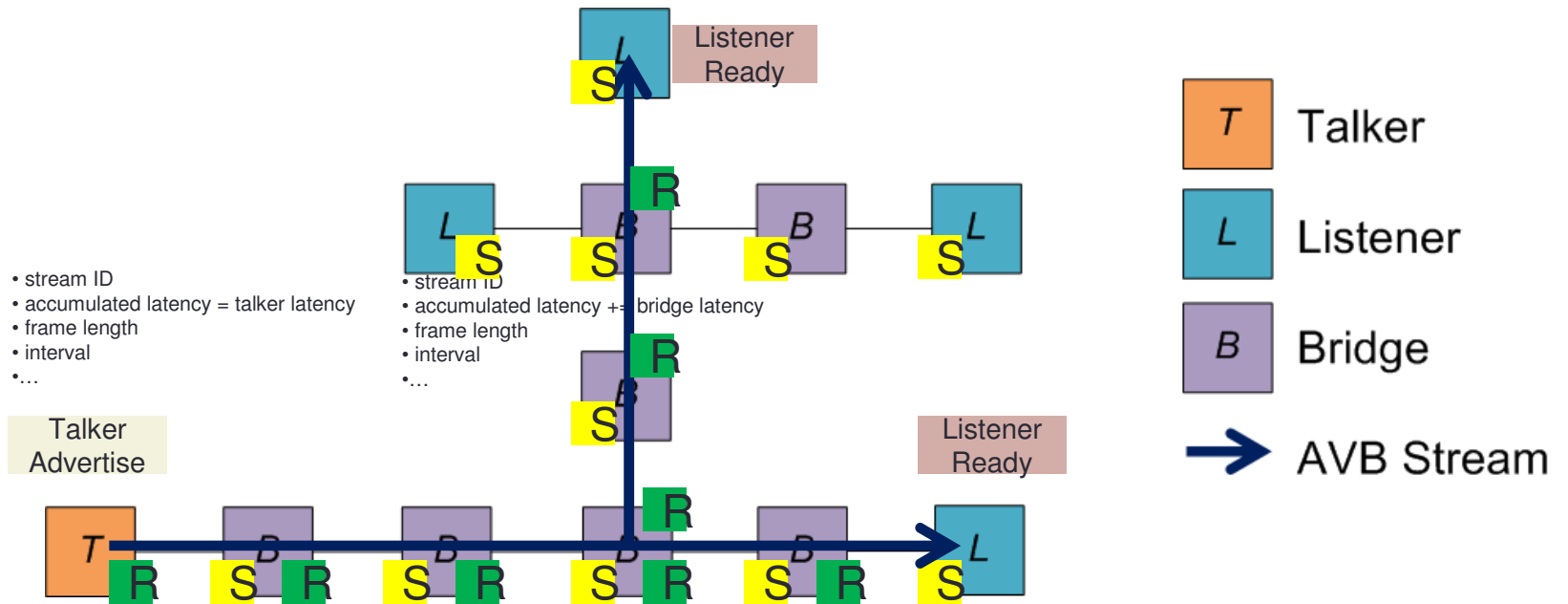

Traffic Shaping

- As audio/video streams require a high bandwidth utilization, it was necessary to set the maximum available bandwidth for this new traffic class quite high (75%)
- Therefore the Credit Based Shaper (CBS) was introduced
- The CBS spaces out the frames as much as possible in order to reduce bursting and bunching
- This behavior:
 - Protects the best effort traffic as the maximum interference (AVB stream burst) for the highest best effort priority is limited and known
 - Protects the AVB streams, as it limits the back to back AVB stream bursts which can interfere in a bridge

Credit Based Shaper

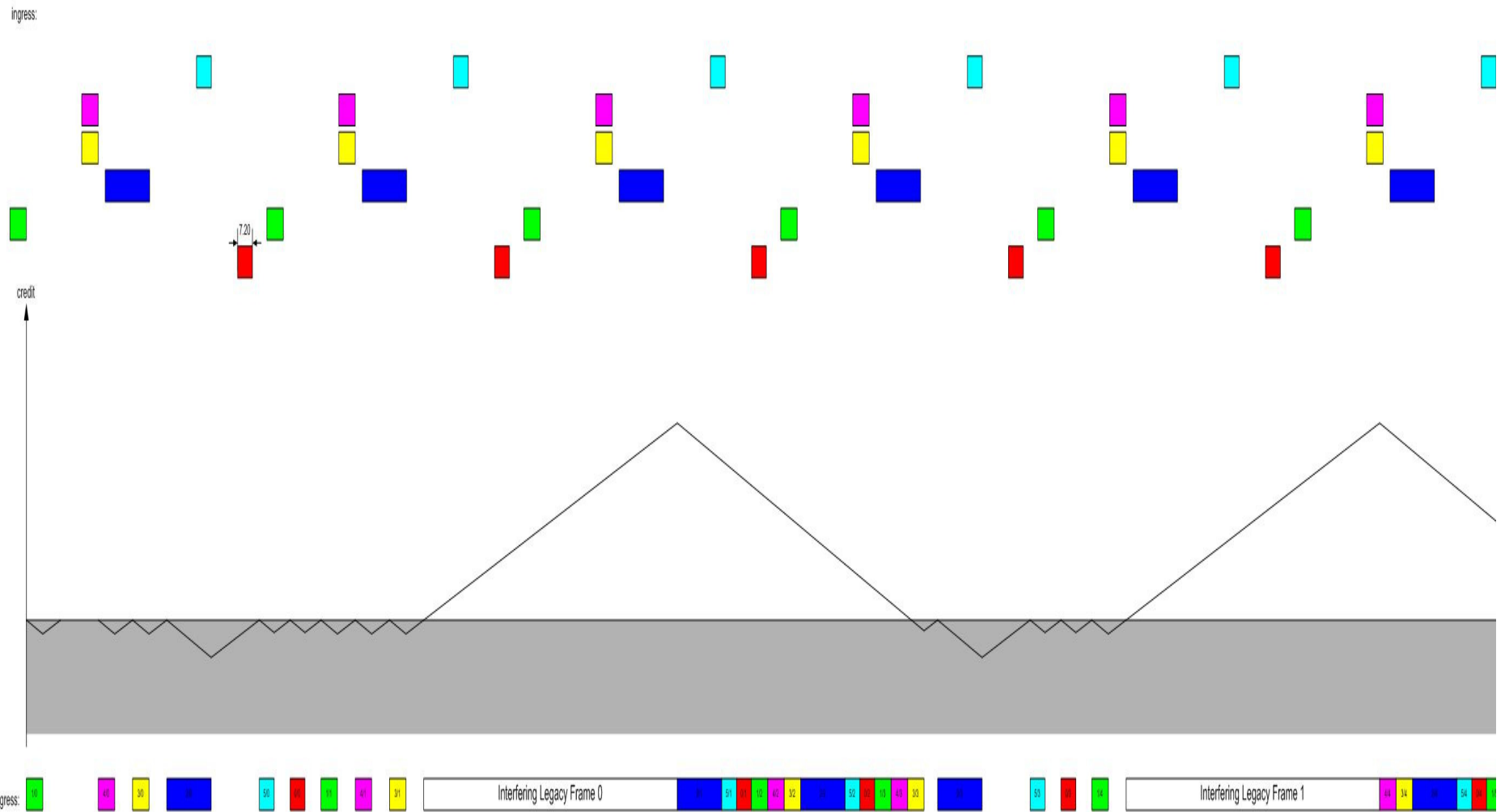

Future Work – Gen2

- The stream reservation protocol and Credit Based Shaper allow for a converged network with IT traffic and high priority SR class traffic (e.g. audio/video streams) with plug and play support
- But as shown before, there are a lot of non audio/video applications in the industrial and vehicle control area with high QoS requirements
- The QoS requirements of some of these applications can't be achieved with the current AVB standards
- Therefore 802.1 started new projects to address the needs of this markets
- These new projects will provide lowest latency for engineered networks

Scheduled Traffic

- The latency requirements in the industrial and vehicle control networks imply a significant reduction of latency (compared to AVB Gen1)
- Therefore it is necessary to prevent from any interference with other lower priority or even same priority traffic
- To prevent from any interference, the high priority traffic has to be scheduled
- IEEE P802.1Qbv will introduce the Time Aware Shaper to allow for Scheduled Traffic
- In order to enforce the schedule throughout a network, the interference with lower priority traffic has to be prevented, as this would not only increase the latency but also the delivery variation
- Hence the Time Aware Shaper blocks the non Scheduled Traffic, so that the port is idle when the Scheduled Traffic is scheduled for transmission

Time Aware Shaper

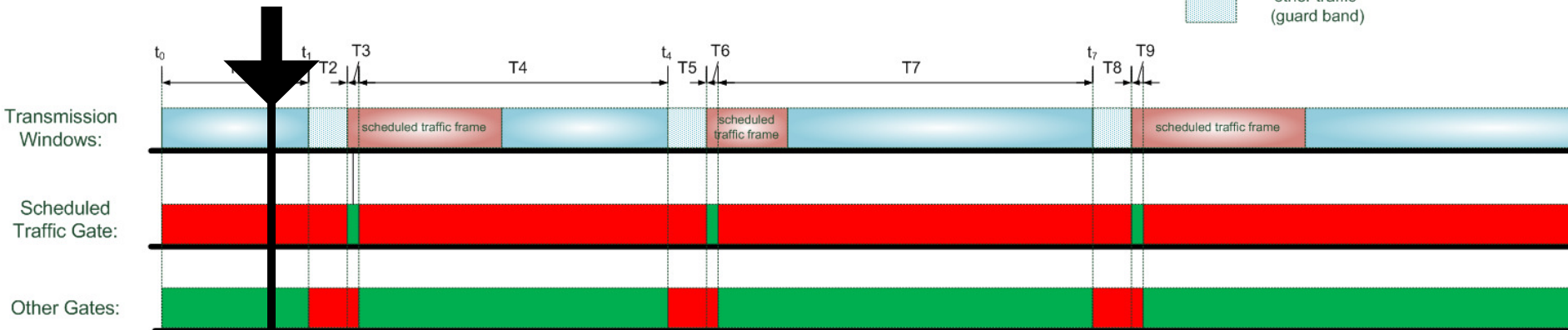
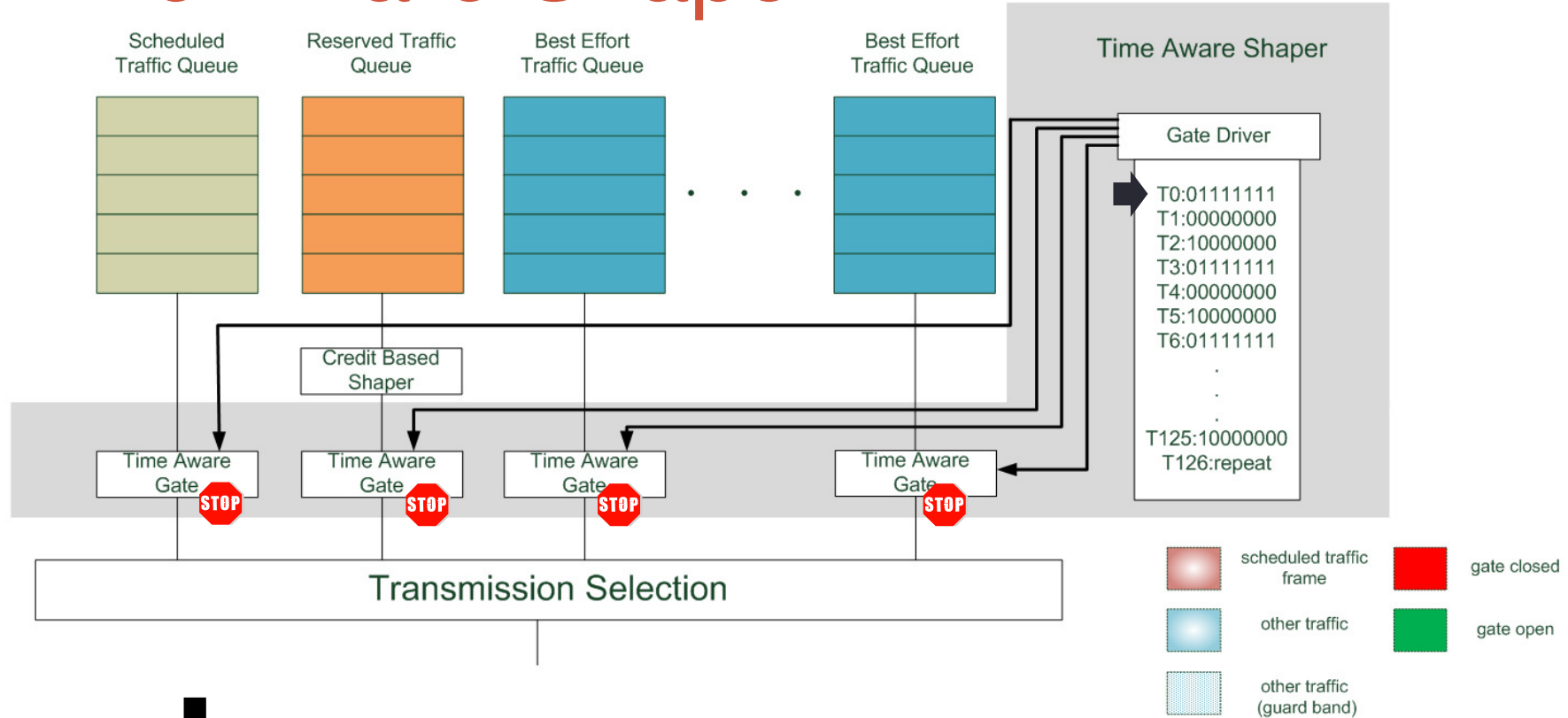

QoS Summary

- Audio Video Bridging introduced mechanisms for the convergence of IT networks and audio/video networks
- Audio Video Bridging guarantees bandwidth for reserved streams and best effort traffic
- Audio Video Bridging guarantees a certain latency for reserved streams
- Scheduled Traffic will provide mechanisms to guarantee minimum latency for industrial and vehicle control applications
- Studying additional improvements for converged networks which support all three types of traffic in one network

IEEE 802.1aq – SHORTEST PATH BRIDGING

János Farkas, Ericsson

Paul Unbehagen, Avaya

Don Fedyk, Alcatel-Lucent

Acknowledgements

- Many people contributed to 802.1aq SPB, which is a significant add-on to 802.1Q
- The editors
 - Don Fedyk and Mick Seaman
- Major contributors
 - David Allan, Peter Ashwood-Smith, Nigel Bragg, Jérôme Chiabaut, János Farkas, Stephen Haddock, Ben Mack-Crane, Panagiotis Saltsidis and Paul Unbehagen
- This section also involves their contribution

Section Contents

- An insight to IEEE 802.1aq **Shortest Path Bridging (SPB)**
 - SPB is a **control protocol** → Existing data plane leveraged
Standardized by IEEE 802.1 → **Compatible** with other 802.1 standards; both backwards and “forward” (due to backwards compatibility of future standards)
- The insight involves:
 - A quick look on the data plane
 - Paradigm shift in the control plane → **Link state** for bridges
 - **A lot of capabilities** → Advantages and applications
 - What comes next?

802.1Q Bridge Architecture – Separated Control and Data Planes

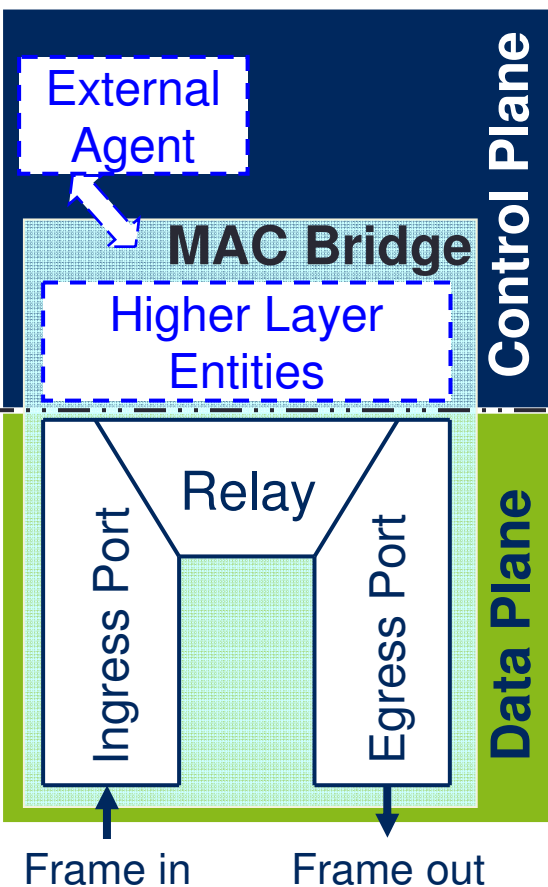

Control Options (details in the coming slides)

- Even simultaneous control within a network region, e.g.:

| | | | |
|--------------------|---------------------------------|---------------------|-------------------------|
| VLAN space: | spanning tree VLANs | shortest path VLANs | software defined VLANs |
| Control: | Multiple Spanning Tree Protocol | SPB | PBB-Traffic Engineering |

Virtual Networks

several overlay combinations are possible; names do not bound applications, e.g. PBB is great for data centers

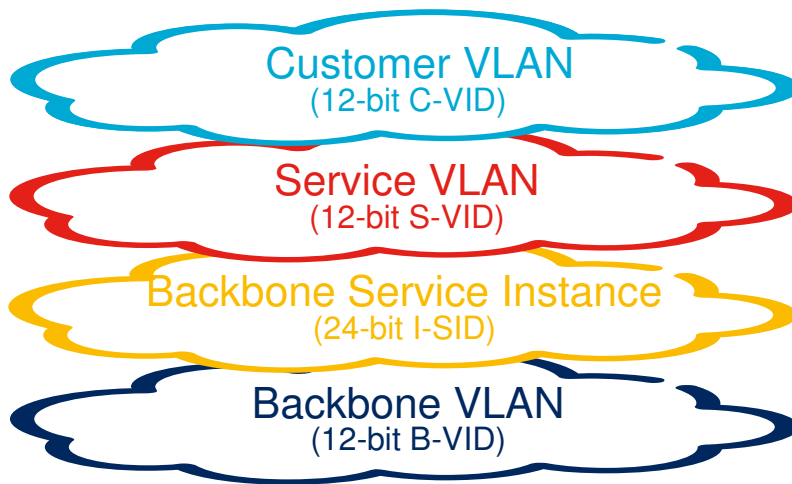

network virtualization and QoS

Provider Bridges (PB) / "Q-in-Q" / **scalability** → 4K VID problem **solved**

Provider Backbone Bridges (PBB) / "MAC-in-MAC" / **scalability and separation** → **Forget about** 4K VID problem

24-bit I-SID > 16 million virtual networks

Uniform forwarding: Destination MAC + VLAN ID (VID)

Control Plane Evolution

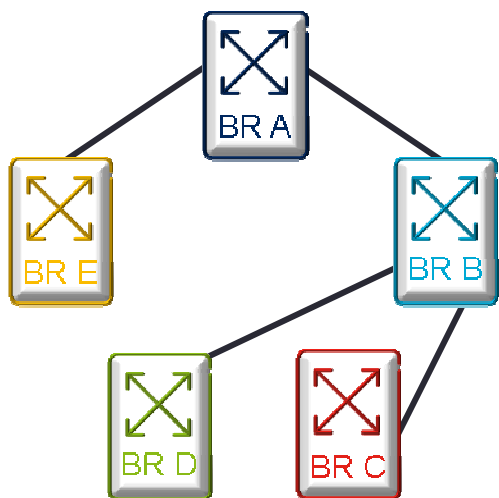

RSTP

Rapid Spanning Tree Protocol

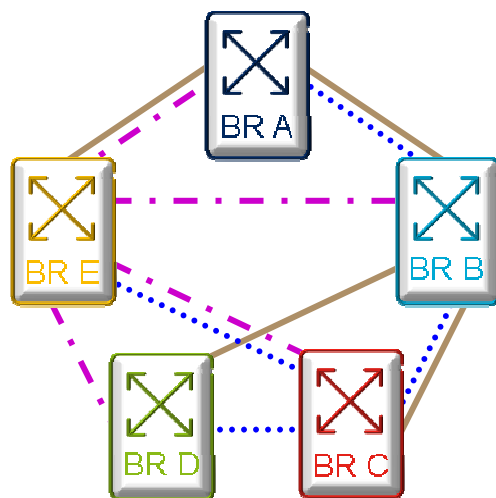

MSTP

Multiple Spanning Tree Protocol

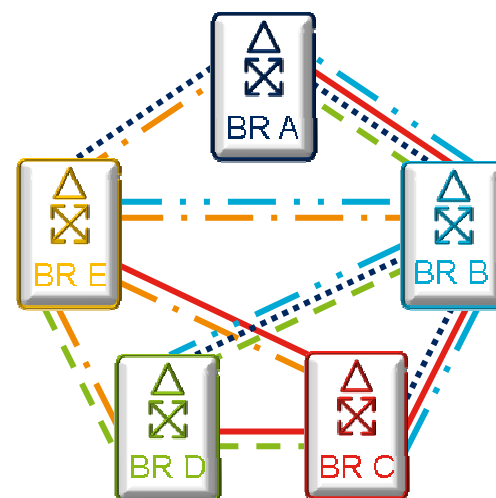

SPB

- RSTP: a single spanning tree shared by all traffic
- MSTP: different VLANs may share different spanning trees
- SPB: each node has its own **Shortest Path Tree (SPT)**
- ***We are not limited to shared spanning trees any more***

Note: the Spanning Tree Protocol (STP) is historical, it has been replaced by RSTP

SPB in a Nutshell

- SPB applies a link state control protocol to MAC Bridging
 - Based on the ISO **Intermediate System to Intermediate System (IS-IS)** intra-domain routing information exchange protocol → **ISIS-SPB**
 - Leverages the automation features of link state, e.g. auto-discovery
 - Preserves the MAC Service model, e.g. delivery in-order
- ISIS-SPB operation
 - Link state data base → Identical replica at each bridge
 - Topology information
 - Properties of the bridges
 - Service information
 - Computation instead of signaling or registration protocols
 - Leverage Moore's law and technology trends
- ISIS-SPB specifications
 - IEEE 802.1aq specifies operation and backwards compatibility provisions
 - ISIS extensions for SPB (new TLVs) also documented in IETF RFC 6329

SPB Operation Modes

- A bridge only uses its own SPT for frame forwarding
 - Destination MAC + VID based forwarding allows two options to realize the SPTs

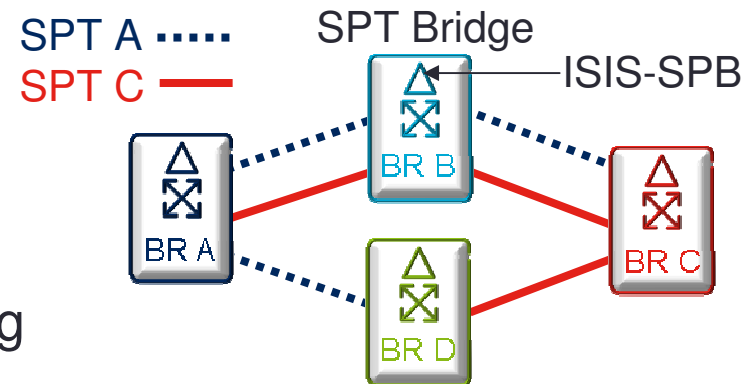

SPB has two operation modes

The implementation of the same principles to forwarding is different

• **SPBM**: SPB MAC

- Backbone MAC identified SPTs
- Designed to leverage the scalability provided by PBB /“MAC-in-MAC”/
- No flooding and learning
- Managed environments

• **SPBV**: SPB VID

- VID identified SPTs
- Applicable to all types of VLANs
- Flooding and learning
- Plug&play

Load Spreading

- Using the shortest path automatically spreads traffic load to some extent
- Further load-spreading by exploiting equal cost paths to create multiple SPT Sets
 - Up to 16 standard tie-breaking variations to produce diverse SPTs
- Provisioned load spreading
 - A VLAN is assigned to an SPT Set

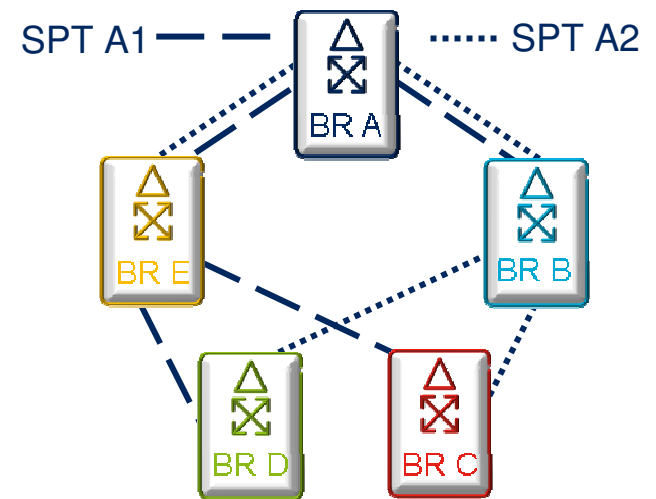

SPT options for Bridge A

SPB Application Examples

- Data Center
 - SPBM → large and scalable Layer 2 fabric in a Data Center
 - All the links are used
 - Virtual Machines / servers / routers can freely move anywhere
- Time Sensitive Networks
 - Shortest path for time sensitive traffic

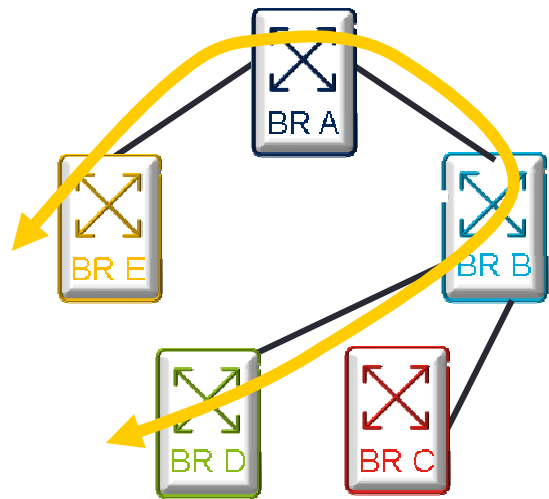

spanning tree roundabout

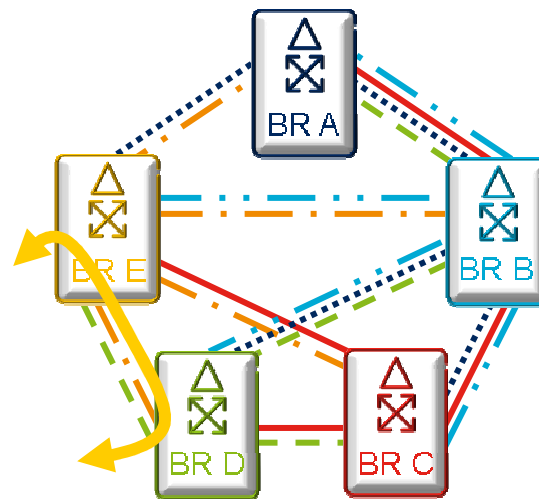

shortest path

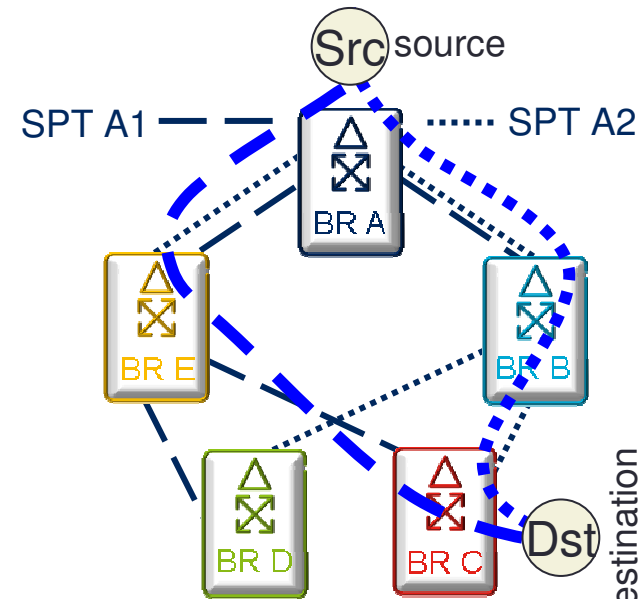

multiple copies

SPB Summary: A Great Feature Set

- Single link state control for large networks
- High degree of automation
- Scalability (thousand nodes)
- Deterministic multiple shortest path routing
- Optimum multicast
- Minimized address learning
- Fast convergence (within the range of 100 msec)
- All 802.1 standards supported, e.g.
 - Connectivity Fault Management (802.1ag CFM)
 - Edge Virtual Bridging (802.1Qbg EVB)
- Metro Ethernet Forum (MEF) services natively provided
 - E-LINE, E-TREE, E-LAN

Ongoing SPB Related Activities

- Deployments
 - Multiple vendors shipping product
 - Three Interops so far: Alcatel-Lucent, Avaya, Huawei, Solana, Spirent
- 802.1Qbp – Equal Cost Multiple Paths (ECMP) – Ongoing project
 - Per hop load balancing for unicast
 - Shared trees for multicast
 - Standardized Flow Hash → OAM enabler
 - New tag to carry Flow Hash and TTL
- 802.1Qca – Path Control and Reservation – Project proposal
 - Beyond shortest path → Explicit path control
 - Leveraging link state for
 - Bandwidth and stream reservation
 - Redundancy (protection or restoration) for data flows
 - Distribution of control parameters for time synchronization and scheduling
- More on IS-IS based future in the next section by Norm

MIXED-TECHNOLOGY NETWORKING

Norman Finn, Cisco Systems

Mixed-technology Networking

There are two senses in which 802.1 is pursuing mixed-technology networking.

- **Bridging together diverse media.**
- **Simultaneous use of different topology control protocols and QoS mechanisms.**

Both are essential in achieving the goal of providing “convergence”: a single network that can support both mission-critical industrial or vehicular control applications, and more general traffic such as audio, video, and bulk data transfer.

Diverse Media

- In the early days of IEEE 802, bridges used the Spanning Tree protocol to interconnect 802.3 Ethernet, 802.5 Token Ring, FDDI, and other technologies into one network.
- Over the years, only 802.3 survived in the market.
- 802.1 is again reaching out to integrate multiple technologies into a bridged network:
 - **IEEE 802.11** Wi-Fi
 - **IEEE 1901** Broadband Over Power Line
 - Multimedia over Coax Alliance (**MoCA**)
 - More??
- The object is to allow stations on any of these media to speak freely with stations of the same or other media via standard bridges.

Diverse Media

- IEEE 1901 and MoCA are fairly obvious applications. The lack of Wi-Fi integration may surprise some.
- IEEE 802.11 Wi-Fi has been defined, up to now, as providing **access** to a network, **not** as a medium **internal** to a network.
- Networks such as this one are **not possible** within the current IEEE 802 standards:
- New PARs, introduced by 802.1 and 802.11 this week, will support such network topologies.

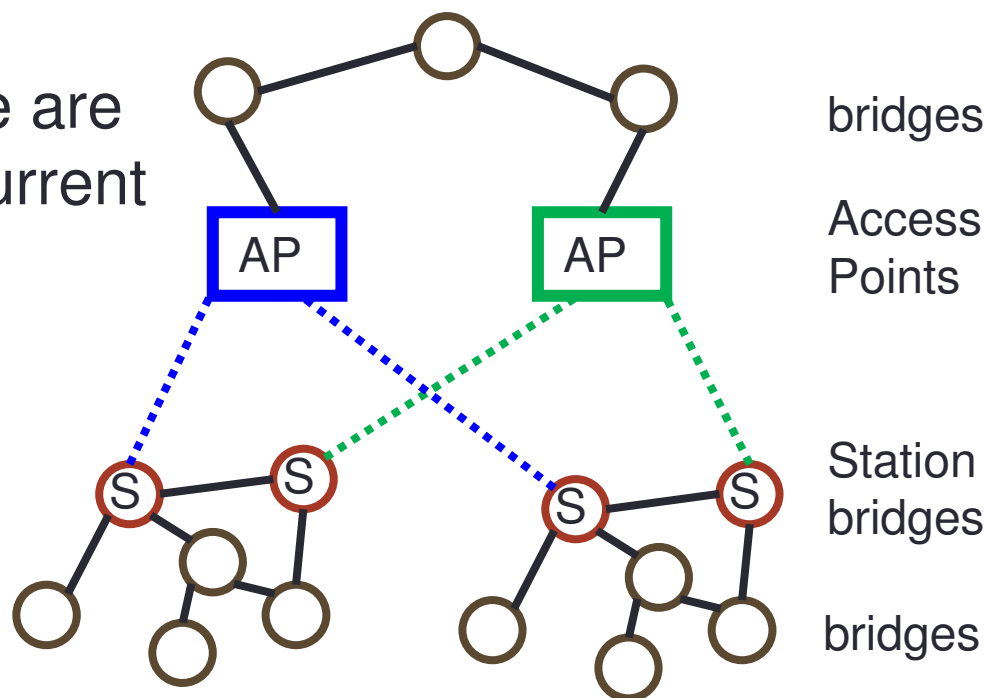

Multiple Topology Control Protocols

In the industrial and vehicular markets, there are many different mechanisms for topology control protocols that provide robust networks in the face of possible failures:

- **No redundancy.** Very simple, but not very resilient.
- **Rings.** Fast (10ms) failure recovery, but high hop count.
- **Spanning tree.** Guaranteed connectivity, plug-and-play, but poor worst-case recovery time and high hop count.
- **Duplicate delivery.** 0-time failure recovery, but costs in configuration effort and bandwidth.
- **Shortest Path Bridging.** Good recovery time, guaranteed connectivity, but expensive in CPU cycles and training.

Multiple Qualities of Service

As mentioned earlier in this tutorial, there are many different Quality of Service features desired by designers and users of industrial and vehicular networks:

- **Priority-base best-effort.** Most important goes, less important waits.
- **Fair queuing.** Most important is more favored, less important waits more, all get at least some bandwidth.^{bridges}
- **Reserved flows.** Make reservations for max-bandwidth flows; those flows get latency and delivery guarantees.
- **Scheduled transmissions.** Specific frames transmitted at specific times on a repeating schedule.

Proper use of QoS permits the **convergence** of network usage models.

Multiplication of Solutions

- At present, various public standards bodies and industry consortia provide different standards for topology control and QoS; they often compete for market- and mind-share.
- A single user in a single network can have needs not addressable by any one topology control + QoS suite.
- Furthermore, there is increasing pressure to integrate industrial and vehicular control networks into larger company networks, or into the Big-I Internet, at Layer 3 and above; this introduces many more topology control and QoS ideas.

Seeing the Forest, Not Just Trees

- Ultimately, an industrial control or vehicular network is made of boxes and connections passing packets. There are two decisions to be made for every packet:
 - On **what** port (if any) is this packet to be sent? (**FORWARDING**)
 - Given that there are potentially many packets queued up on the selected output port, **when** is this packet sent? (**QoS**)
- We make this observation: **QoS decisions are largely orthogonal to forwarding decisions.** That is, the various topology control protocols, even if operating at Layer 2 and Layer 3, **have to cooperate** and interoperate at the port level to decide which packet to send next on this connection.

Simultaneous Topology Control

- The standard IEEE 802.1 data forwarding mechanism (the “802.1 data plane”) supports most standard topology control protocols, covering all of the classes mentioned, earlier (spanning tree, SPB, rings, etc.) by many different standards bodies (ISO/IEC, ITU-T, etc.)
- The standard IEEE 802.1 QoS mechanisms are the most complete of any standard, at either Layer 2 or Layer 3, for converged industrial and vehicular control networks.

Simultaneous Topology Control

- By separating traffic into Virtual Local Area Networks (VLANs), different topology control protocols can support data flows simultaneously on the same physical network.

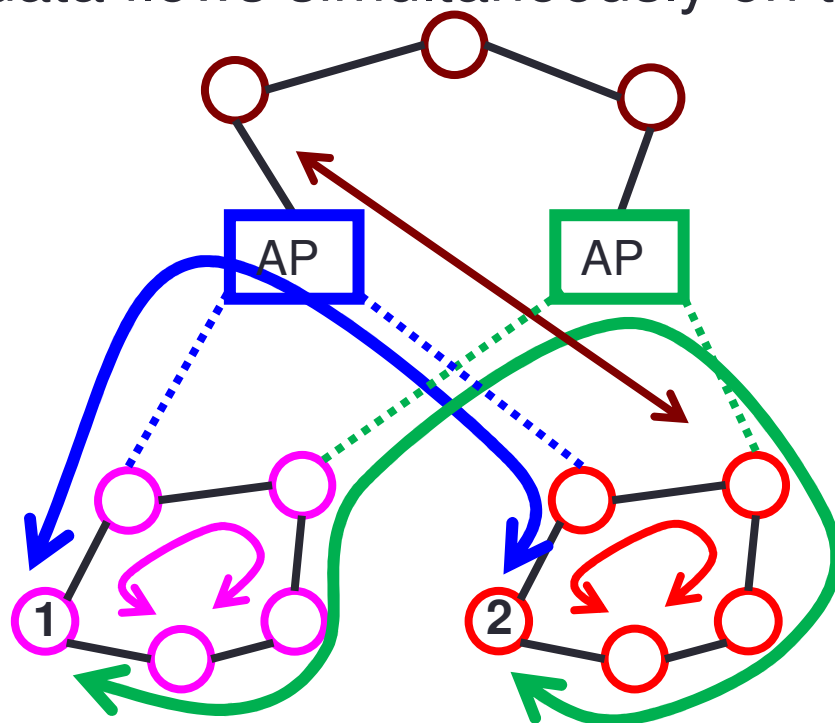

3. Ring protocol runs VLAN 5 for local data.

4. Ring protocol runs VLAN 6 for local data.

1. SPB-V protocol runs VLAN 1, that reaches everywhere, for management purposes.

2. Traffic engineered paths use VLAN 8 and VLAN 9 for duplicate delivery.

Frames controlled by different topology control protocols can use the same Priority values, and hence the same queues and the can get the same QoS features.

And Under It All – ISIS

- Underlying these networks is a “glue” protocol: the ISO Intermediate System to Intermediate System protocol, ISIS. (Hopefully, with a simplified subset for use by simple devices, in order to enable trading capability for development and deployment costs.)
- Using ISIS to report the network topology, carry QoS protocols (such as bandwidth reservation), and support new features provides now-competing standards organizations with a neutral ground for feature development that will be beneficial to all.

SUMMARY

Deterministic Ethernet

- Existing (audio/video streams) and new (industrial and vehicular control) applications
 - Time synchronization
 - Rich Quality of Service offerings
 - Choices for network resiliency
 - Widely deployed (hence, cheap) switching elements
 - Foundation for cooperation among standards organization
- Enables converged networks where real-time and bulk data can be comingled without disrupting the mission critical tasks.

REFERENCES

IEEE 802.1 Standards – Audio Video Bridging (AVB)

- IEEE 802.1AS-2011, “IEEE standard for local and metropolitan area networks: Timing and synchronization for time-sensitive applications in bridged local area networks,” March 2011.
<http://standards.ieee.org/getieee802/download/802.1AS-2011.pdf>
- IEEE 802.1BA-2011, “IEEE standard for local and metropolitan area networks: Audio video bridging systems,” 2011.
<http://standards.ieee.org/findstds/standard/802.1BA-2011.html>

IEEE 802.1 Standards – Data Center Bridging (DCB)

- IEEE 802.1BR, “IEEE standard for local and metropolitan area networks: Media access control (MAC) bridges and virtual bridged local area networks: Bridge port extension,” 2012.
<https://standards.ieee.org/findstds/standard/802.1BR-2012.html>
- IEEE 802.1Qaz, “IEEE standard for local and metropolitan area networks: Media access control (MAC) bridges and virtual bridged local area networks – Amendment 18: Enhanced transmission selection for bandwidth sharing between traffic classes,” September 2011.
<http://standards.ieee.org/getieee802/download/802.1Qaz-2011.pdf>
- IEEE 802.1Qbb, “IEEE standard for local and metropolitan area networks: Media access control (MAC) bridges and virtual bridged local area networks – Amendment 17: Priority-based flow control,” September 2011.
<http://standards.ieee.org/getieee802/download/802.1Qbb-2011.pdf>
- IEEE 802.1Qbg, “IEEE standard for local and metropolitan area networks: Media access control (MAC) bridges and virtual bridged local area networks – Amendment 21: Edge virtual bridging,” 2012.
<http://standards.ieee.org/findstds/standard/802.1Qbg-2012.html>

IEEE 802.1 Standards – Interworking

- IEEE 802.1AB-2009, “IEEE standard for local and metropolitan area networks: Station and media access control connectivity discovery,” September 2009. <http://standards.ieee.org/getieee802/download/802.1AB-2009.pdf>
- IEEE 802.1AX-2008, “IEEE standard for local and metropolitan area networks: Link aggregation,” November 2008. <http://standards.ieee.org/getieee802/download/802.1AX-2008.pdf>
- IEEE 802.1D-2004, “IEEE standard for local and metropolitan area networks: Media access control (MAC) bridges,” June 2004. <http://standards.ieee.org/getieee802/download/802.1D-2004.pdf>
- IEEE 802.1H-1997, “IEEE technical report and guidelines - Part 5: Media access control (MAC) bridging of Ethernet V2.0 in local area networks,” May 2002, <http://standards.ieee.org/getieee802/download/802.1H-1997.pdf>
- IEEE 802.1Q-2011, “IEEE standard for local and metropolitan area networks: Media access control (MAC) bridges and virtual bridged local area networks,” August 2011. <http://standards.ieee.org/getieee802/download/802.1Q-2011.pdf>
- IEEE 802.1aq, “IEEE standard for local and metropolitan area networks: Media access control (MAC) bridges and virtual bridged local area networks – Amendment 20: Shortest path bridging,” June 2012. <http://standards.ieee.org/findstds/standard/802.1aq-2012.html>
- IEEE 802.1Qbc, “IEEE standard for local and metropolitan area networks: Media access control (MAC) bridges and virtual bridged local area networks – Amendment 16: Provider bridging: Remote customer service interfaces,” September 2011. <http://standards.ieee.org/getieee802/download/802.1Qbc-2011.pdf>
- IEEE 802.1Qbe, “IEEE standard for local and metropolitan area networks: Media access control (MAC) bridges and virtual bridged local area networks – Amendment 15: Multiple I-SID registration protocol,” September 2011. <http://standards.ieee.org/getieee802/download/802.1Qbe-2011.pdf>
- IEEE 802.1Qbf, “IEEE standard for local and metropolitan area networks: Media access control (MAC) bridges and virtual bridged local area networks – Amendment 19: PBB-TE infrastructure segment protection,” December 2011. <http://standards.ieee.org/getieee802/download/802.1Qbf-2011.pdf>
- Note that 802.1Q-2011 incorporates amendments 802.1ad-2005, 802.1ak-2007, 802.1ag-2007, 802.1ah-2008, 802.1Q-2005/Cor-1-2008, 802.1ap-2008, 802.1Qaw-2009, 802.1Qay-2009, 802.1aj-2009, 802.1Qav-2009, 802.1Qau-2010, and 802.1Qat-2010.

IEEE 802.1 Standards – Security

- IEEE 802.1AE-2006, “IEEE standard for local and metropolitan area networks: Media access control (MAC) security,” August 2006.
<http://standards.ieee.org/getieee802/download/802.1AE-2006.pdf>
- IEEE 802.1AEbn-2011, “IEEE standard for local and metropolitan area networks: Media access control (MAC) security amendment 1: Galois counter code - Advanced encryption standard - 256 (GCM-AES-256) cipher suite,” October 2011.
<http://standards.ieee.org/getieee802/download/802.1AEbn-2011.pdf>
- IEEE 802.1AR-2009, “IEEE standard for local and metropolitan area networks: Secure device identity,” December 2009.
<http://standards.ieee.org/getieee802/download/802.1AR.-2009.pdf>
- IEEE 802.1X-2010, “IEEE standard for local and metropolitan area networks: Port-based network access control,” February 2010.
<http://standards.ieee.org/getieee802/download/802.1X-2010.pdf>

Ongoing IEEE 802.1 Projects

- Audio Video Bridging (may be renamed to Time Sensitive Networking)
 - P802.1ASbt, “Draft standard for local and metropolitan area networks: Timing and synchronization: Enhancements and performance improvements,” <http://www.ieee802.org/1/pages/802.1asbt.html>
 - P802.1Qbv, “Draft standard for local and metropolitan area networks: Media access control (MAC) bridges and virtual bridged local area networks – Amendment: Enhancements for scheduled traffic,” <http://www.ieee802.org/1/pages/802.1bv.html>
 - P802.1Qbu, “Draft standard for local and metropolitan area networks: Media access control (MAC) bridges and virtual bridged local area networks – Amendment: Frame preemption,” <http://www.ieee802.org/1/pages/802.1bu.html>
- Interworking
 - P802-REV, “Draft standard for local and metropolitan area networks: Overview & architecture,” Revision, <http://www.ieee802.org/1/pages/802-rev.html>
 - P802.1AX-REV, “IEEE standard for local and metropolitan area networks: Link aggregation,” Revision incorporating Distributed Resilient Network Interconnect (DRNI), <http://www.ieee802.org/1/pages/802.1AX-rev.html>
 - P802.1Qbp, “Draft standard for local and metropolitan area networks: Media access control (MAC) bridges and virtual bridged local area networks – Amendment: Equal cost multiple paths (ECMP),” <http://www.ieee802.org/1/pages/802.1bp.html>
- Security
 - P802.1AEbw, “IEEE standard for local and metropolitan area networks: Media access control (MAC) security – Amendment : Extended packet numbering,” <http://www.ieee802.org/1/pages/802.1aebw.html>
- Note that access to “802.1 private area” is free. Access control is just a very basic tool to filter really interested readers/contributors. Ask 802.1 people!

IEEE 802.1 Project Proposals

- P802.1ACby, “Support by Ethernet over Media Oriented Systems Transport (MOST)”
 - PAR: <http://www.ieee802.org/1/files/public/docs2012/new-p802-1ACby-draft-par-0912.pdf>
 - Five Criteria : <http://www.ieee802.org/1/files/public/docs2012/new-p802-1ACby-draft-5c-0912.pdf>
 - <http://www.ieee802.org/1/pages/802.1acby.html>
- P802.1Qbz, “Enhancements to Bridging of 802.11”
 - PAR: <http://www.ieee802.org/1/files/public/docs2012/new-p802-1Qbz-draft-par-0912.pdf>
 - Five Criteria : <http://www.ieee802.org/1/files/public/docs2012/new-p802-1Qbz-draft-5c-0912.pdf>
- P802.1Qca, “Path Control and Reservation”
 - PAR: <http://www.ieee802.org/1/files/public/docs2012/new-p802-1Qca-draft-par-0912-v03.pdf>
 - Five Criteria: <http://www.ieee802.org/1/files/public/docs2012/new-p802-1Qca-draft-5c-0912-v03.pdf>

Further Reading

- Book, papers

- D. Allan and N. Bragg, “802.1aq shortest path bridging design and evolution: The architect's perspective,” *John Wiley & Sons*, January 2012.
<http://onlinelibrary.wiley.com/book/10.1002/9781118164327>
- D. Allan, J. Farkas, and S. Mansfield, “Intelligent load balancing for shortest path bridging,” *IEEE Communications Magazine*, July 2012.
<http://ieeexplore.ieee.org/xpl/articleDetails.jsp?arnumber=6231293>
- D. Allan, P. Ashwood-Smith, N. Bragg, J. Farkas, D. Fedyk, M. Ouellete, M. Seaman, and P. Unbehagen, “Shortest path bridging: Efficient control of larger Ethernet networks,” *IEEE Communications Magazine*, October 2010.
<http://ieeexplore.ieee.org/xpl/articleDetails.jsp?arnumber=5594687>
- D. Allan, P. Ashwood-Smith, N. Bragg, and D. Fedyk, “Provider link state bridging,” *IEEE Communications Magazine*, September 2008.
http://ieeexplore.ieee.org/xpls/abs_all.jsp?arnumber=4623715
- M. Alizadeh, A. Kabbani, B. Atikoglu, and B. Prabhakar, “Stability Analysis of QCN: The Averaging Principle,” *Proceedings of the ACM Special Interest Group on Computer Systems Performance, SIGMETRICS 2011*, 2011.
<http://www.stanford.edu/~balaji/papers/11stabilityanalysis.pdf>
- M. Alizadeh, B. Atikoglu, A. Kabbani, A. Laksmikantha, R. Pan, B. Prabhakar, and M. Seaman, “Data center transport mechanisms: congestion control theory and IEEE standardization,” *Proceedings of the 46th Annual Allerton Conference on Communications, Control and Computing*, September 2008. <http://www.stanford.edu/~balaji/papers/QCN.pdf>

- Wikipedia

- Audio Video Bridging: http://en.wikipedia.org/wiki/Audio_Video_Bridging
- Shortest Path Bridging: http://en.wikipedia.org/wiki/IEEE_802.1aq

ABBREVIATIONS

| | | | |
|-----------------|---|-------------------|---|
| AVB | Audio Video Bridging | MAC-in-MAC | used for PBB |
| AP | Access Point | MEF | Metro Ethernet Forum |
| BMCA | Best Master Clock Algorithm | MoCA | Multimedia over Coax Alliance |
| B-VID | Backbone VLAN ID | MSTP | Multiple Spanning Tree Protocol |
| B-VLAN | Backbone VLAN | OAM | Operations, Administration and Maintenance |
| CBS | Credit Based Shaper | PAR | Project Authorization Request |
| CM | Clock Master | PB | Provider Bridge |
| CS | Clock Slave | PBB | Provider Backbone Bridge |
| C-VID | Customer VLAN ID | PBB-TE | Provider Backbone Bridging - Traffic Engineering |
| C-VLAN | Customer VLAN | PCR | Path Control and Reservation |
| CFM | Connectivity Fault Management | PTP | Precision Time Protocol |
| ECMP | Equal Cost Multiple Paths | Q-in-Q | used for PB |
| E-LINE | Ethernet Line (point-to-point) service | QoS | Quality of Service |
| E-LAN | Ethernet LAN (multipoint) service | SDH | Synchronous Digital Hierarchy |
| E-TREE | Ethernet Tree (rooted multipoint) service | S-VID | Service VLAN ID |
| EVB | Edge Virtual Bridging | S-VLAN | Service VLAN |
| IEC | International Electrotechnical Commission | SPB | Shortest Path Bridging |
| IEEE | Institute of Electrical and Electronic Engineers | SPBM | Shortest Path Bridging MAC |
| IETF | Internet Engineering Task Force | SPBV | Shortest Path Bridging VID |
| FDDI | Fiber Distributed Data Interface | SPT | Shortest Path Tree |
| GM | Grand Master | SR | Stream Reservation |
| IP | Internet Protocol | SRP | Stream Reservation Protocol |
| I-SID | Backbone Service Instance Identifier | SONET | Synchronous Optical Networking |
| IS-IS | Intermediate System to Intermediate System | STP | Spanning Tree Protocol |
| ISIS-SPB | IS-IS for SPBV and SPBM | RFC | Request For Comments |
| ISO | International Organization for Standardization | RSTP | Rapid Spanning Tree Protocol |
| ITU | International Telecommunication Union | TLV | Type, Length, Value |
| ITU-T | ITU Telecommunication Standardization Sector | VID | VLAN Identifier |
| LAN | Local Area Network | VLAN | Virtual LAN |
| MAC | Media Access Control | VoIP | Voice over IP |