



中国移动
China Mobile

High Reliability in WAN Network

Ruibo Han, China Mobile
Tongtong Wang, Huawei

IEEE 802.1 TSN, July 2019



www.10086.cn

Four basic scenarios

Site to Site

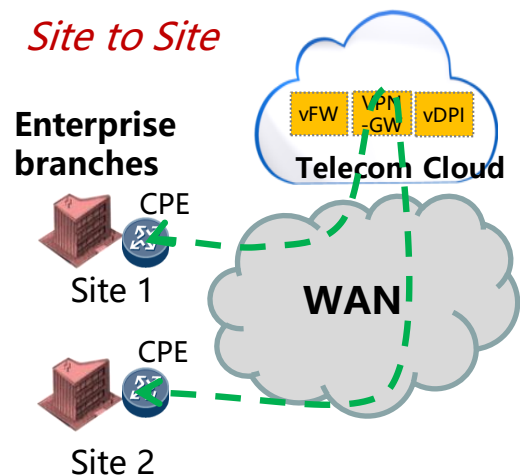

Site to Internet

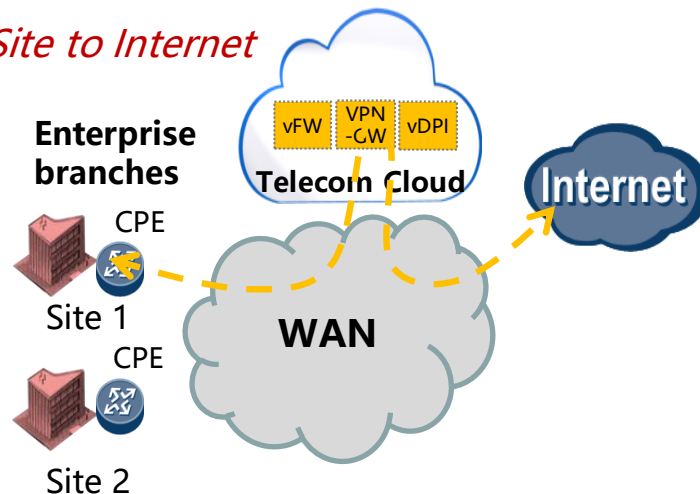

Four basic scenarios in Software-Defined WAN,

- Site to site
- Site to internet
- Site to cloud
- Cloud to cloud

Highly reliable enterprise connections are appealing for service provider networks;

- High resolution video conference;
- 8K video surveillance;
- ...

Site to Cloud

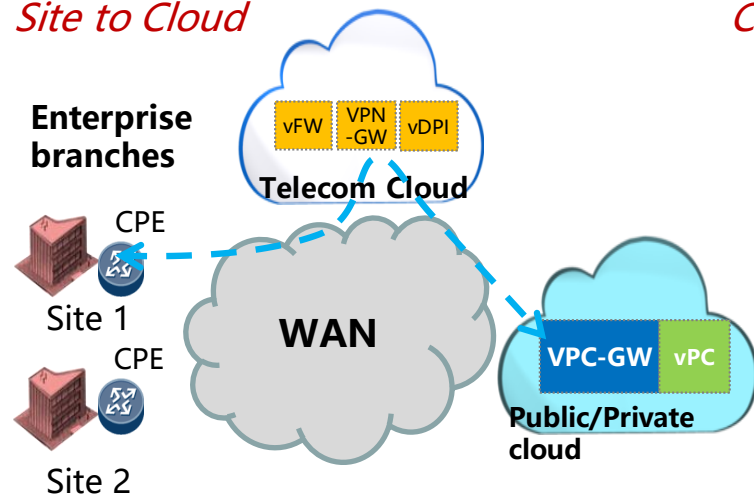

Cloud to Cloud

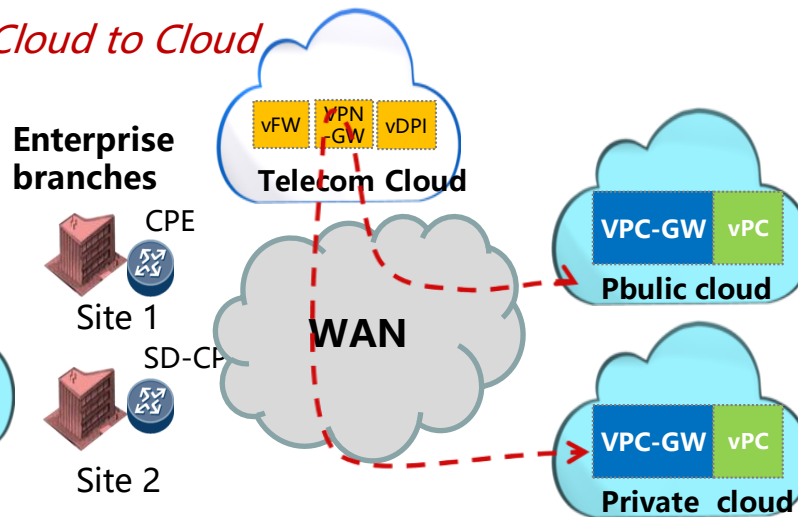

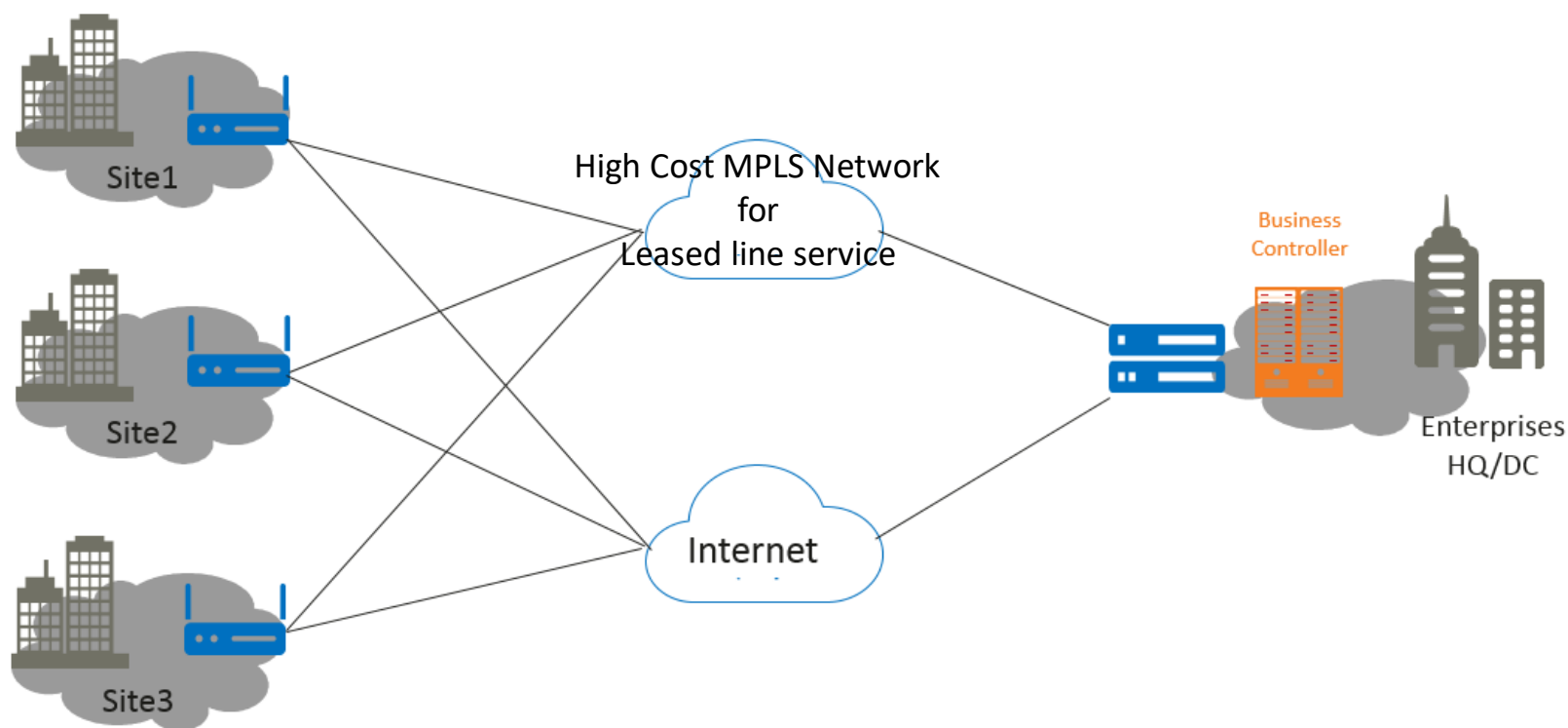

It is a tendency to use multiple internet connections for some high reliable P2P connections between different remote sites or between branch site and cloud servers, rather than lease line, for better cost-efficiency;

Rough calculation for reliability on multiple IP connections is, with n replication path;

$$R = 1 - (1 - r_1) * (1 - r_2) * (1 - r_3) \dots * (1 - r_n); \quad r_1 \text{ is reliability on link 1 and so on;}$$

Assuming every link is independent with each other.

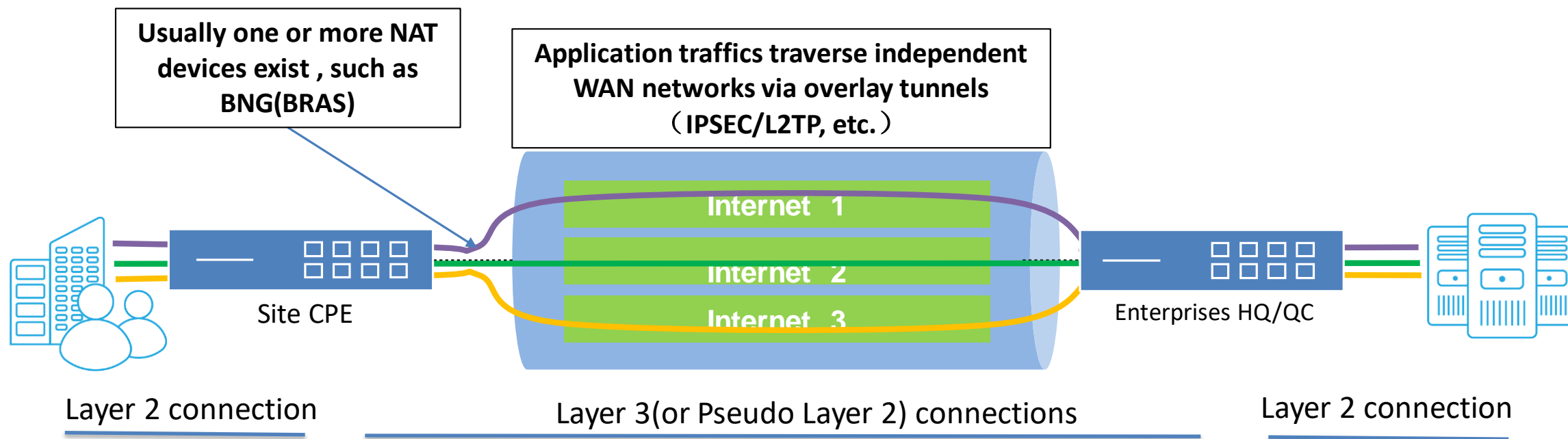

- Typically a SD-WAN connection creates path tunnels over WAN networks between two SD-WAN devices, over different internet connections with various quality (PON, 3G/4G, Metro Ethernet, etc.);
- Establish encrypted WAN paths through WAN overlay tunnels;
- User traffic may need to traverse one or more NAT devices (such as BNG/BRAS, etc.);
- Is FRER helpful in these scenarios to improve reliability? And how?
A Site CPE device may work on L2 / L3. And FRER could be a way to generate sequence number and transmit duplicate packets over redundant links? Need any negotiation on FRER nodes?

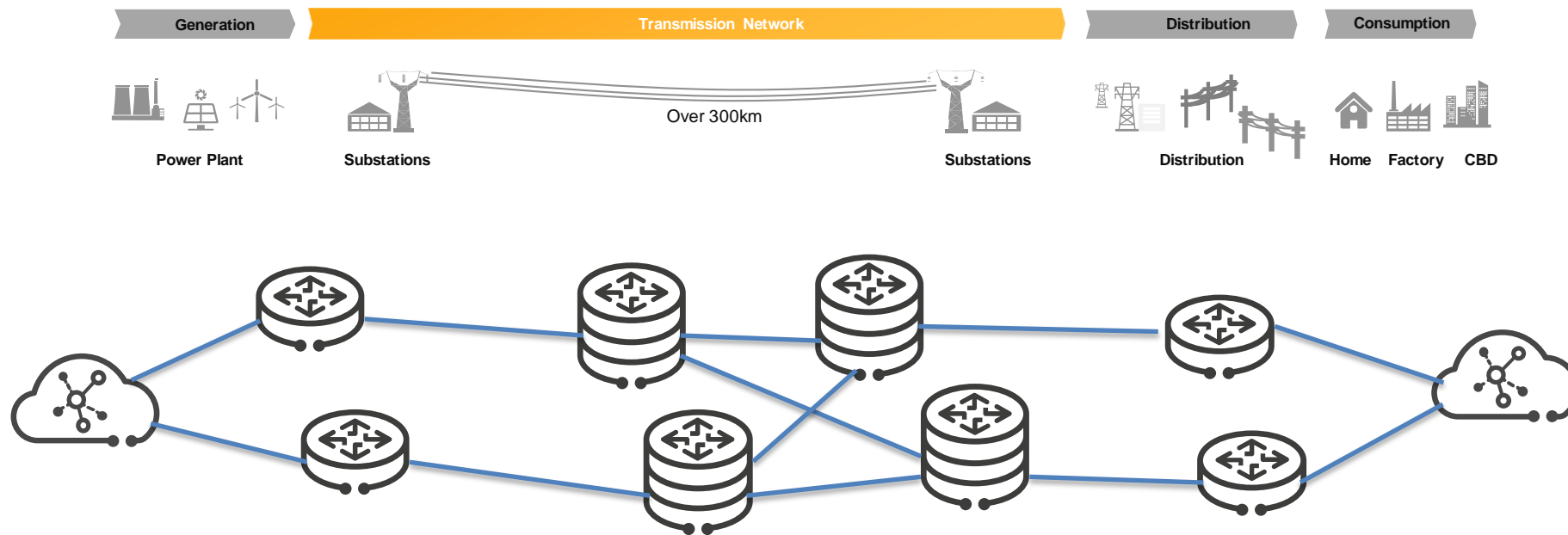

Traditional ICT supports smart grid monitoring and controlling, usually by dedicate wires and separate networks.

Typical smart grid service services require bounded latency, traffic isolation and high reliability;

- Distributed feeder automation
- Millisecond level precise load control
- ...

Recent progress in 5G technologies enable 5G + TSN solution for some vertical applications over service provider network, e.g. in smart grid area, or video surveillance in factories;

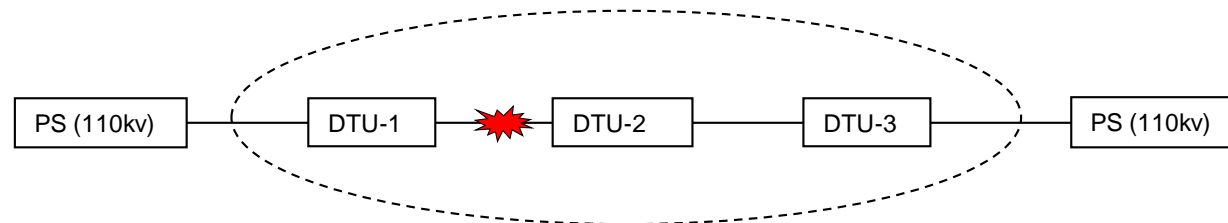

PS: Power Station
DTU: Distribution Terminating Unit

Differential protection implementation in distribution grid

“As illustrated in Figure, all DTUs (e.g., DTU-1, DTU-2, DTU-3) are synchronised with neighbouring DTUs in the distribution grid with a precision of $10 \mu\text{s}$ to ensure that **the current value was sampled at the same time**. The DTU samples the current 24 times within each 20 ms so that a transfer interval of **0,833 ms** is required to exchange the sampled information. **The exchange of measurement samples is done in a strictly cyclic and deterministic manner**. The messages, containing sampled current values, voltage values and so on, are transmitted from a DTU to its neighbouring DTUs with an end-to-end latency of less than 15 ms. The message size is approximately 250 bytes according to IEC 61850, resulting in a service data rate of at least 2 Mbit/s. ”

----- 3GPP R16 , Study on Communications for Automation in Vertical Domains

*

General Protection

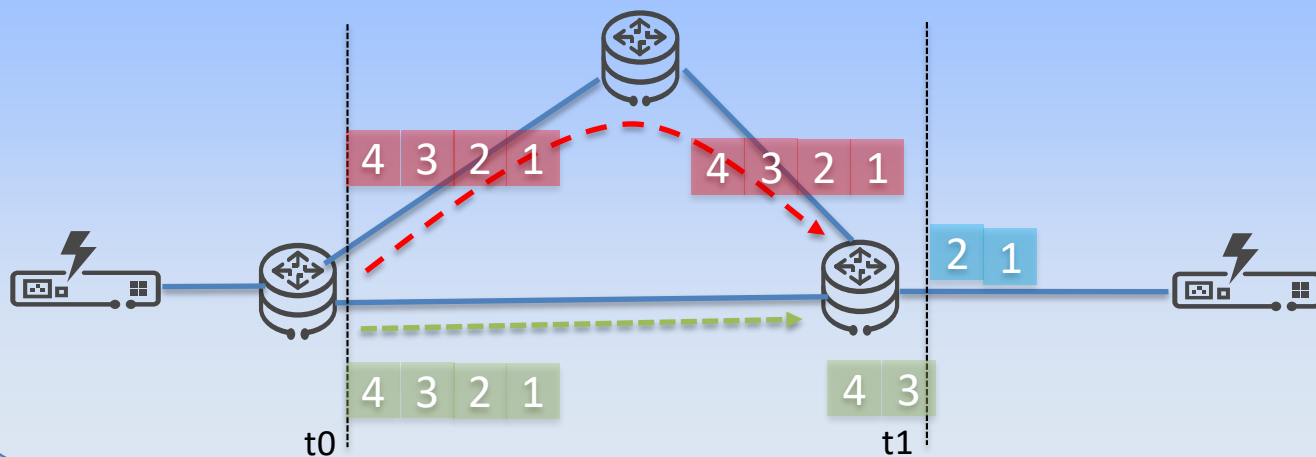

The path causes inconsistent time delay with a much greater t_2 than t_1 , resulting in large jitter of the relay protection equipment.

Seamless Protection

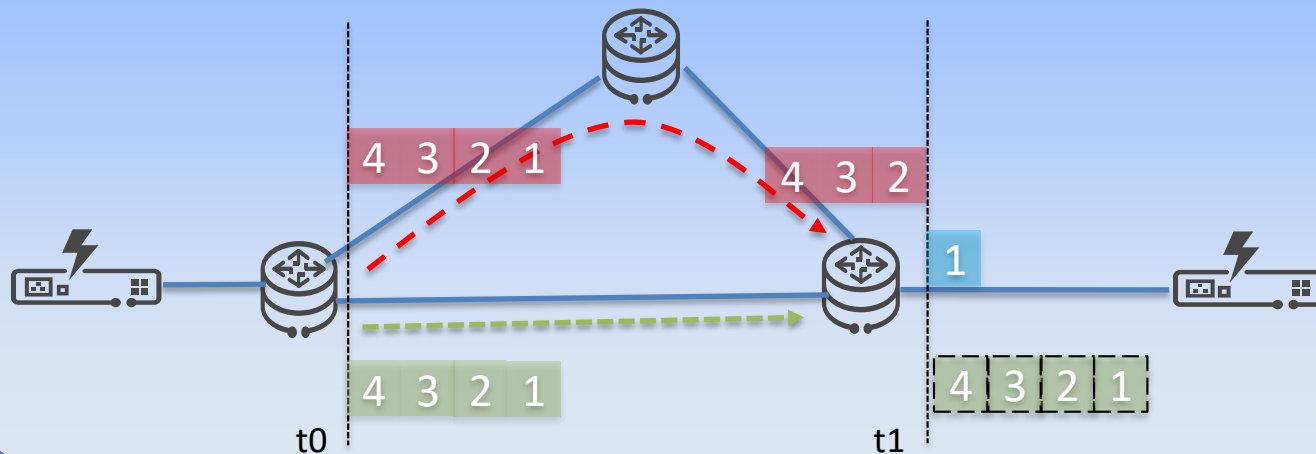

Detects path delay and automatically aligns with it to make sure that failover jitter < 0.1 ms.

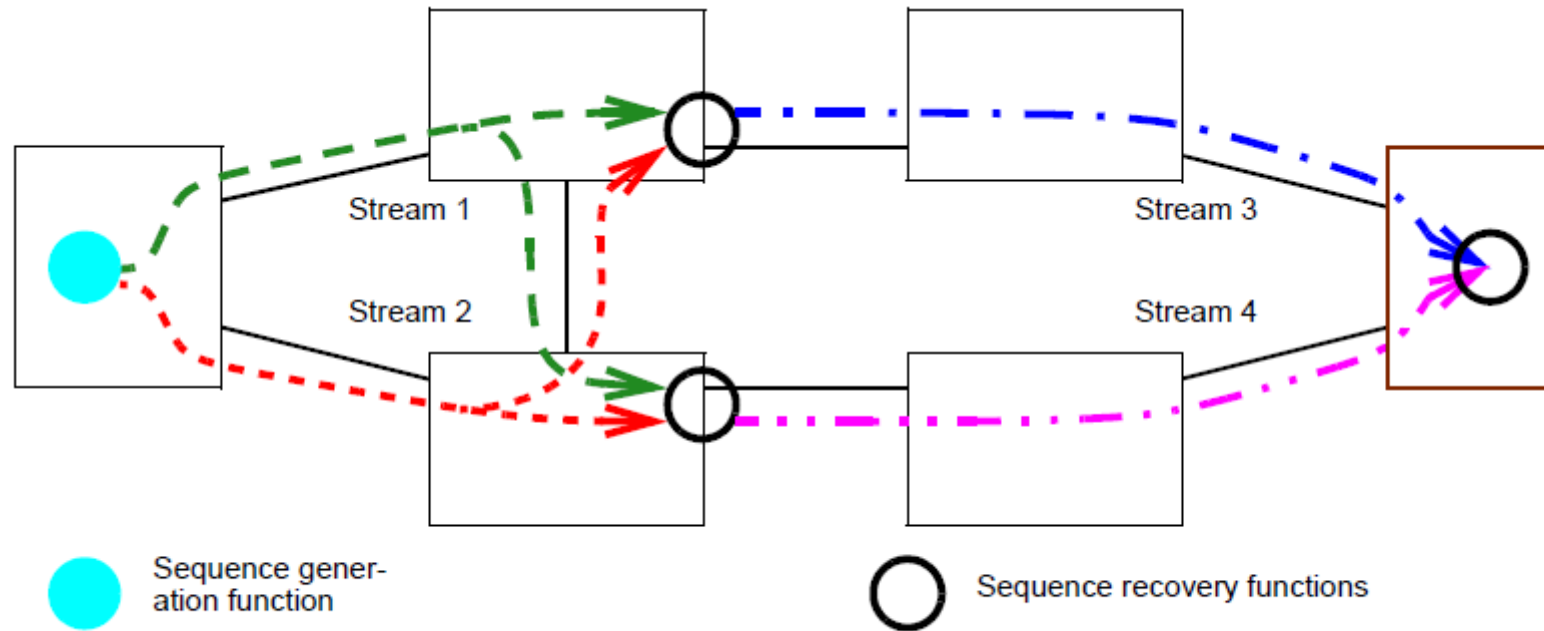

Figure 7-1—Compound Stream built from four Member Streams

Is this a possible solution in L2/L3 mixed scenarios, keeping same 802.1CB sequence number across different network segments? Or any other options?

Is current 802.1CB tags sufficient for enterprises users over encrypted tunnel ?

How to deal with NAT devices when using 802.1CB idea in SP network?

High reliability is one significant requirement in service provider networks, which can help deploying multiple use scenarios.

Prefer to have one converged service provider network providing multiple solutions with differentiated SLA (latency, reliability);

- Single/simple internet connection;
- Multiple internet connections, with FRER capability;
- Bounded latency and highly reliable connections;
e.g. via TSN/DetNet Networks;



中国移动
China Mobile

Thank you.



HUAWEI

www.10086.cn