

Formal Timing Analysis of Ethernet AVB for Industrial Automation

802.1Qav Meeting, Munich, Jan 16-20, 2012

Jonas Rox, Jonas Diemer, Rolf Ernst

{rox|diemer}@ida.ing.tu-bs.de | January 16, 2012

Outline

- Introduction
- Formal Analysis Approach
- Analysis of the “Deggendorf” Use-Case
- Conclusion

Introduction

Research cooperation on „Formal Timing Analysis of Ethernet AVB for Industrial Automation”

(April 2011 – October 2011)

- Participants:
 - Siemens
 - Innovationsgesellschaft Technische Universität Braunschweig (iTUBS)
 - Symtavision

- Goals:
 - Development of a formal method for determining end-to-end latencies in AVB networks
 - Formal analysis of the „Deggendorf“ use case and identification of corner cases for validation via simulation

Motivation

- Determination of the worst case end-to-end latencies in an AVB Network

Approach so far:

1. Identify **general worst case scenario** for a single hop and determine the corresponding local worst case latency
2. End-to-end latency is local worst case latency times the number of hops

Problem: Worst case latency of one hop strongly depends on the network configuration → **general worst case latency** far **too pessimistic**

Possible solution: Simulation of the investigated network configuration

- Network specific latencies (local and end-to-end) can be obtained
- For good coverage, usually **long simulation times** are necessary, but still **no guarantee** that all **corner cases** were considered

Finding the Worst-Case: Formal Analysis vs. Simulation

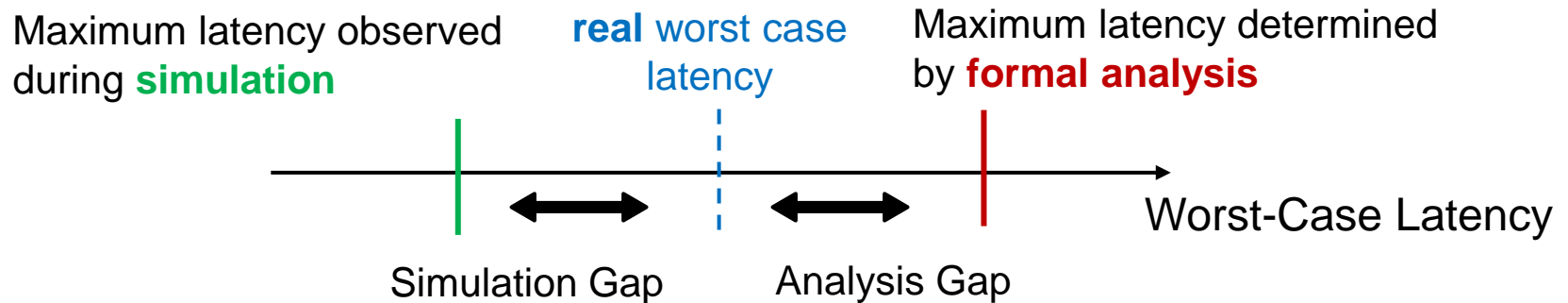

- Latency obtained with simulation \leq the real worst case latency
- Latency obtained with formal analysis \geq the real worst case latency
- Using both methods it is possible to bound the real worst case

Agenda

- Introduction
- **Formal Analysis Approach**
- Analysis of the “Deggendorf” Use-Case
- Conclusion

Compositional Performance Analysis (CPA)

- Performance analysis on **component** and on **system** level
 - Results include
 1. Performance of individual components, e.g. local worst case response times, maximum buffer requirements
 2. System level performance, e.g. end-to-end latencies
- Results are **guaranteed** (formally proven) **upper bounds**
- CPA is very **scalable** and **flexible**, i.e. it can be applied to very large and heterogeneous systems
- CPA is **fast**
- Implemented in the **commercially available** tool SymTA/S which is already used in series development by major automotive OEMs



Compositional Performance Analysis – System Model

- Originally used for scheduling analysis of tasks executing on a distributed platform
- System Model
 - **Resources** -> provide service
 - Scheduled according to policy (e.g. round-robin)
 - **Tasks** -> consume service
 - Activated by events
 - **Event models**
 - Define minimum/maximum number of activations within any time window Δt

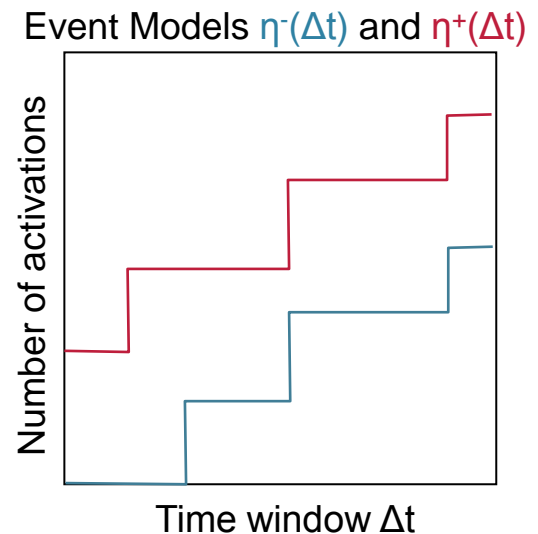
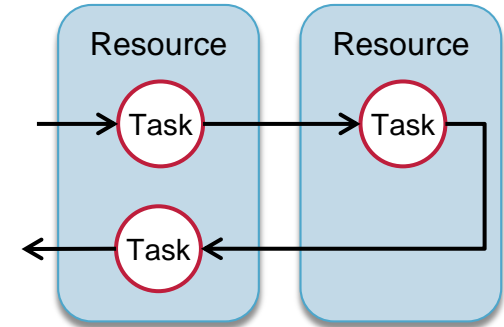

Compositional Performance Analysis – System Analysis

- Analysis performed iteratively
 - Step 1: Local analysis
 - Compute each task's worst-case behavior based on Critical instant scenario
 - Derive task output (completion) event models
 - Step 2: Global analysis
 - Propagate event models to dependent tasks
 - Go to step 1 if any event model has changed
 - Otherwise, terminate

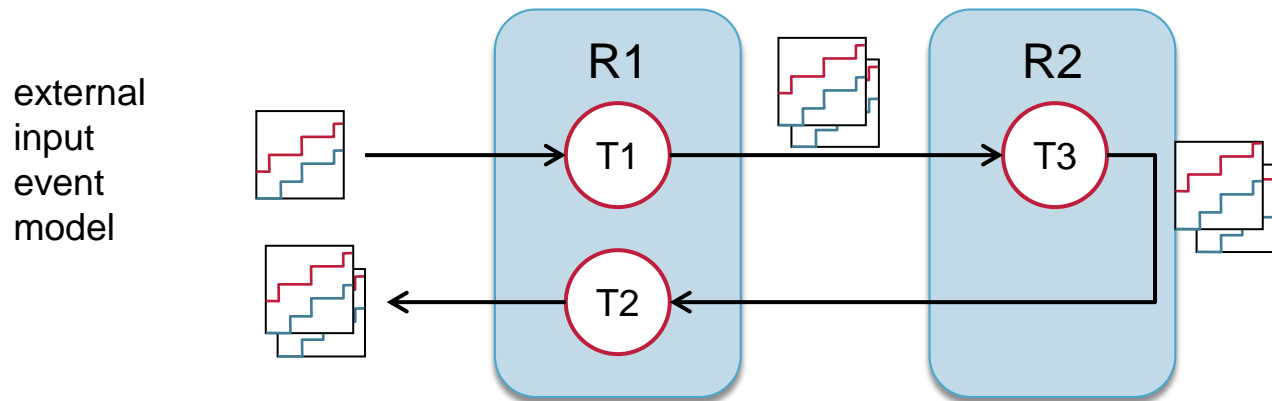

CPA Model for Ethernet AVB (See also [Rox2010SAE])

System model

Output port	→ Processing resource
Class A/B traffic stream	→ Chain of tasks (one task per output port)
Legacy traffic	→ Lower-priority blocker task

Timing model

Arrival of a frame	→ Task activation
Transmission of a frame	→ Task execution

Performance metrics

Queuing delay (per switch)	→ Worst case response times
Stream latency	→ End-to-end path latency

CPA Model for Ethernet AVB (See also [Rox2010SAE])

System model

- Output port → Processing resource
- Class A/B traffic stream → Chain of tasks (one task per output port)
- Legacy traffic → Lower-priority blocker task

Missing piece:

Timing model

- Arrival of a frame
 - Transmission of a frame → Task execution
- Formula for determining the worst case response time under AVB scheduling

Performance metrics

- Queuing delay (per switch) → Worst case response times
- Stream latency → End-to-end path latency

The Missing Piece

$$w_i(q) = T_{transfer}(q) + I_{LPB} + I_{SPB}(w_i(q)) + I_{TSB}(w_i(q)) + I_{HPB}(w_i(q))$$

- Considered sources of delay
 - *Transfer time*: The time to transfer a frame is determined by core execution time (incl. wire delay), not including any blocking (no-load transfer time).
 - *Blocking by lower-priority frame*: Each stream can be blocked by a lower-priority frame that commenced transfer just before the arrival of the stream.
 - *Blocking by same-priority frames*: Since multiple streams can share the same priority class they can potentially block each other.
 - *Blocking by traffic shaping*: A stream may have to wait for shaper credits before it may proceed.
 - *Blocking by higher-priority frames*: All higher-priority frames may block a frame. This blocking is limited by the traffic shaping applied to the high priority classes.

The Benefits

$$w_i(q) = T_{transfer}(q) + I_{LPB} + I_{SPB}(w_i(q)) + I_{TSB}(w_i(q)) + I_{HPB}(w_i(q))$$

- The individual terms are formulated dependent on the frame arrival times
- In compositional system level analysis these arrival times are conservatively determined → **network configuration and topology are considered**
- The result is the worst case latency of a frame traversing a particular switch in a specific AVB network

Agenda

- Introduction
- Formal Analysis Approach for AvB
- **Analysis of the “Deggendorf” Use-Case**
- Conclusion

„Deggendorf“ Use Case: Top-Level Network

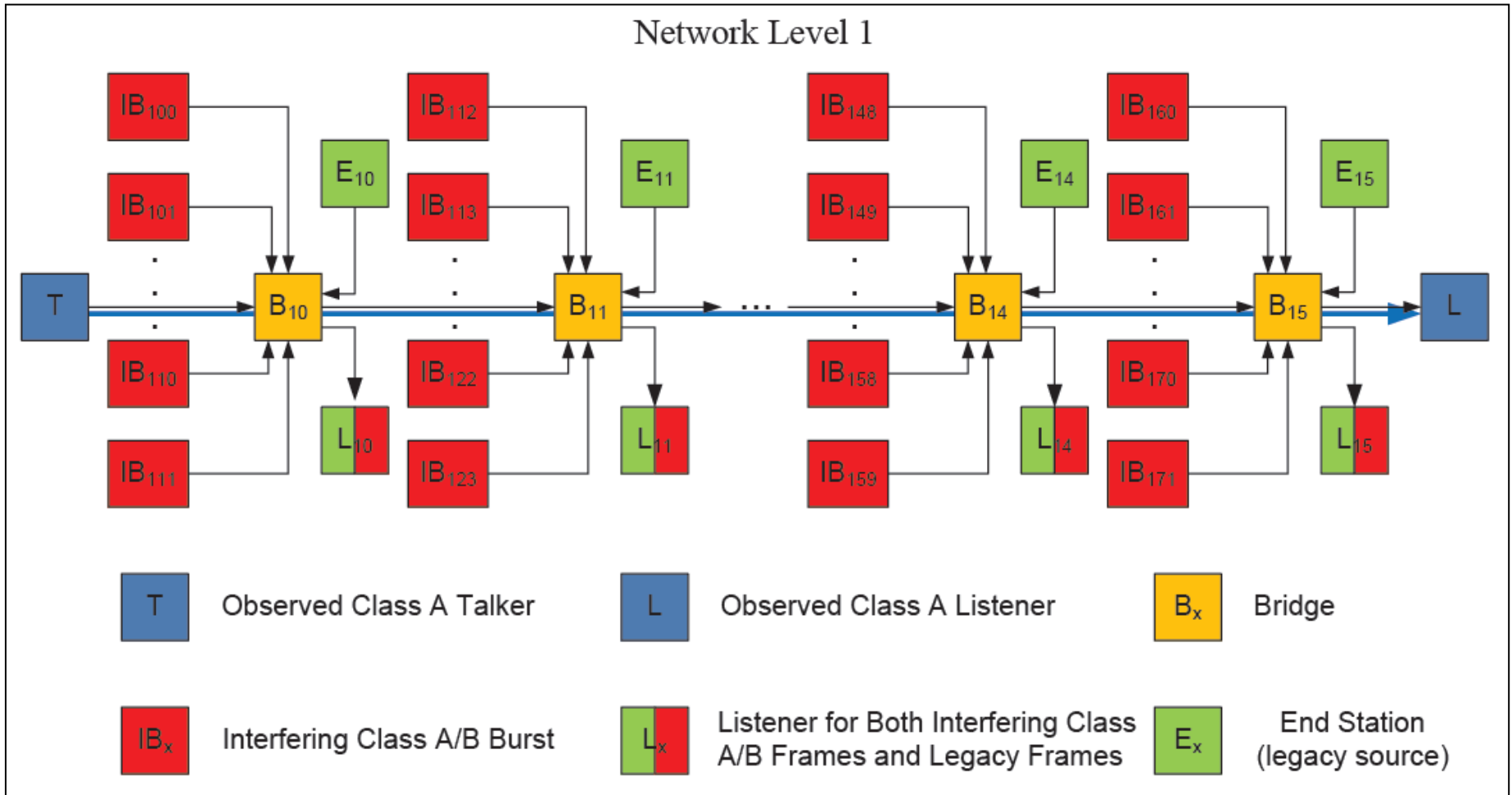

Source: <http://www.ieee802.org/1/files/public/docs2010/ba-boiger-bridge-latency-calculations.pdf>

„Deggendorf“ Use Case: IB Subnetwork

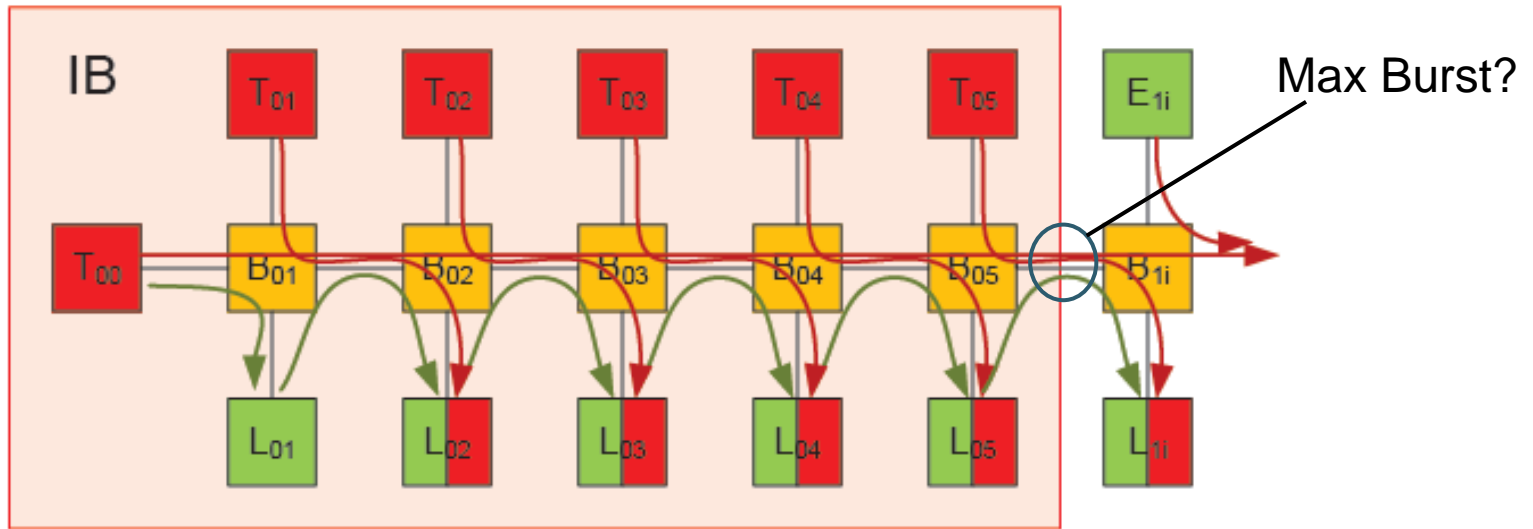

- On each bridge there is an interfering NRT frame from different independent senders
- On each bridge there is interfering Class A traffic from different independent talkers
- Initial assumption made in the simulation: All talkers generate frames periodically fully utilizing their reserved bandwidth

Analysis of the IB Subnetwork

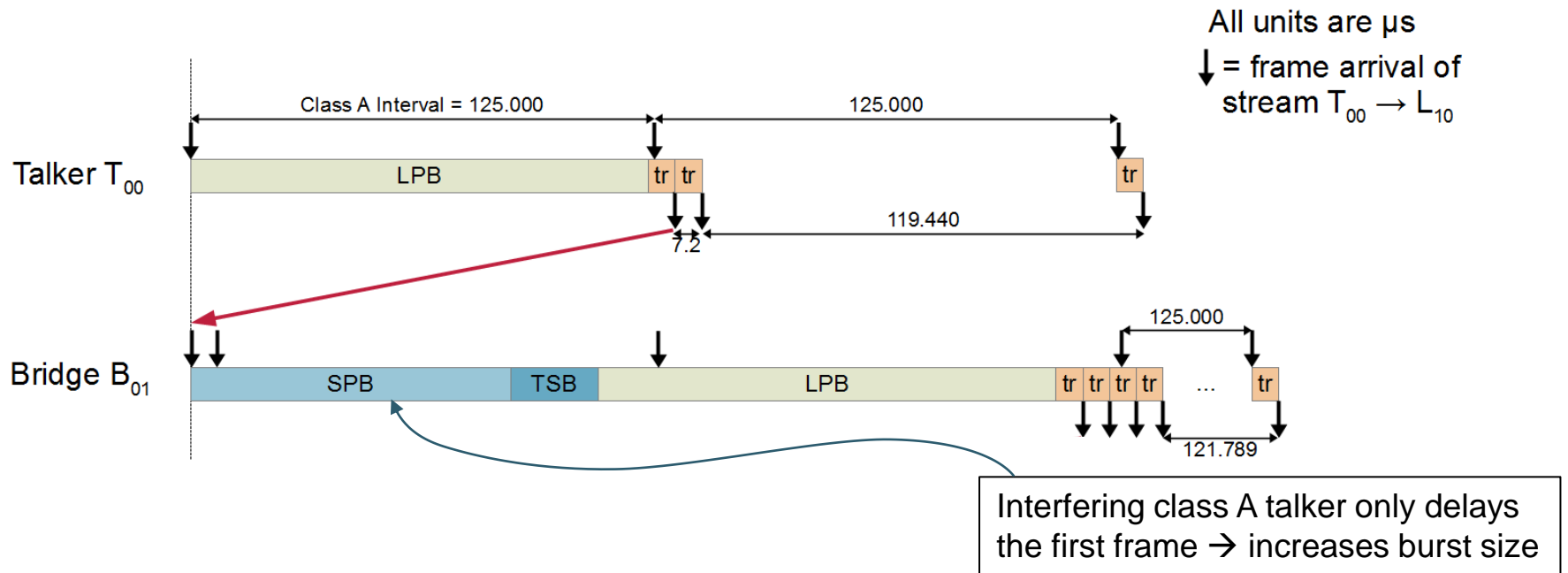

Analysis of the IB Subnetwork

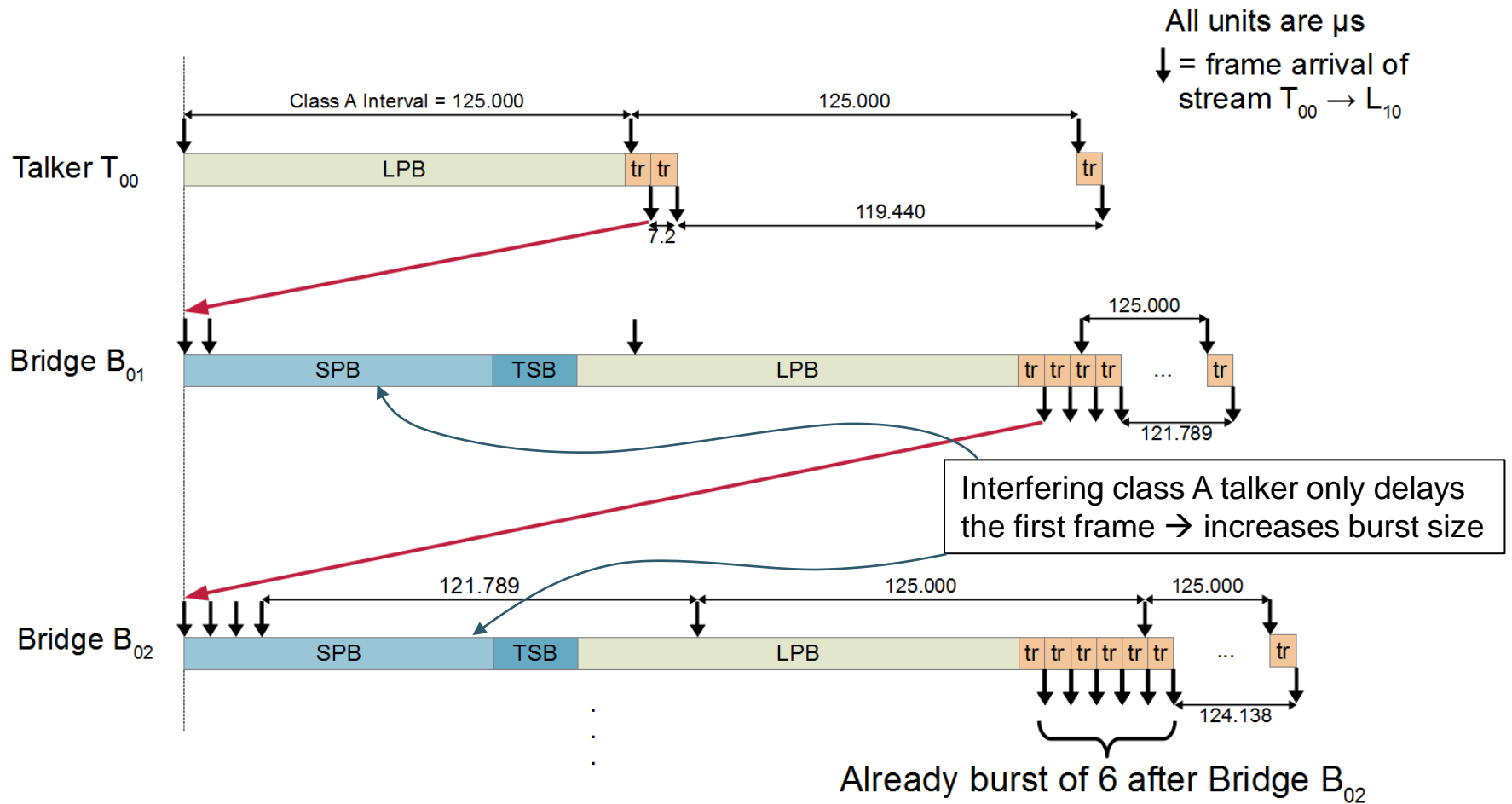

Output Model at the Output Port of the Last Bridge

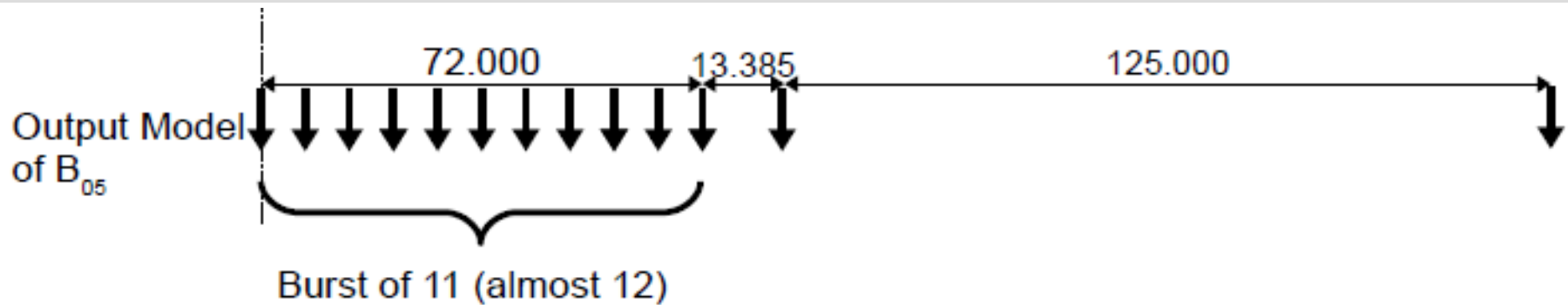

- Burst of 11 (nearly 12) Frames at the output port of the last bridge of the IB subnetwork
- In the simulation only a burst of 7 frames could be observed at the output port of last bridge of the IB subnetwork
 - class A talkers only delaying the first packet of the burst was not considered (see also [Boiger2011March])
- Burst of 11 (nearly 12) can also be observed in simulation if configured accordingly

„Deggendorf“ Use Case: Top-Level Network

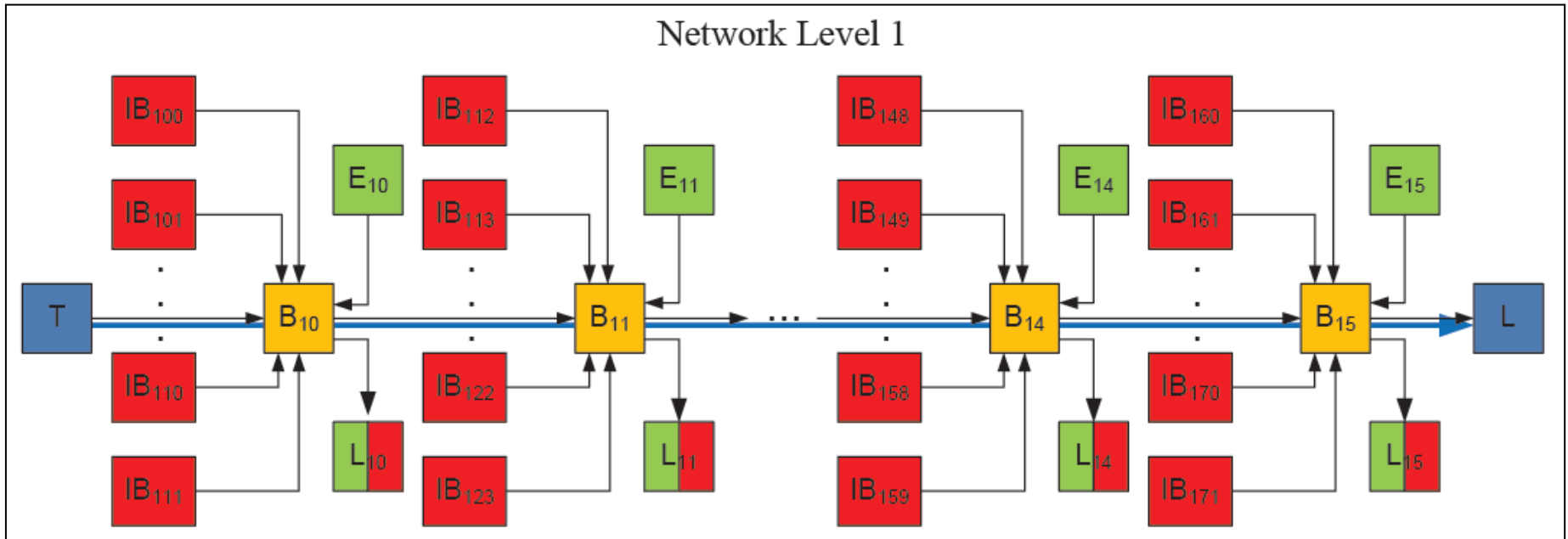

- 12 class A streams, each with an initial burst of 11(12) frames interfere with the analyzed class A frame, **on each bridge** $B_{10} \dots B_{15}$
- All these frames share priority and **compete for the same shaper credit** with the analyzed frame

Results for the Top Level Network

Scenario	Frames in Burst	Top Ivl Bridge Delay	Top Ivl Latency
Sim with initial assumption	7	893.76 μ s	5.493 ms
Compositional Performance Analysis	11 (12 effective)	1.566 ms	8.975 ms
Sim with only first delayed	11 (12 effective)	1.434 ms	8.733 ms

- Formal worst-case could be verified in simulation with less than 3% error
- Found new worst case with significantly higher latency
 - Increased burst at the end of IB subnetwork, due to dropped interference frame

Bounding the Real Worst-Case

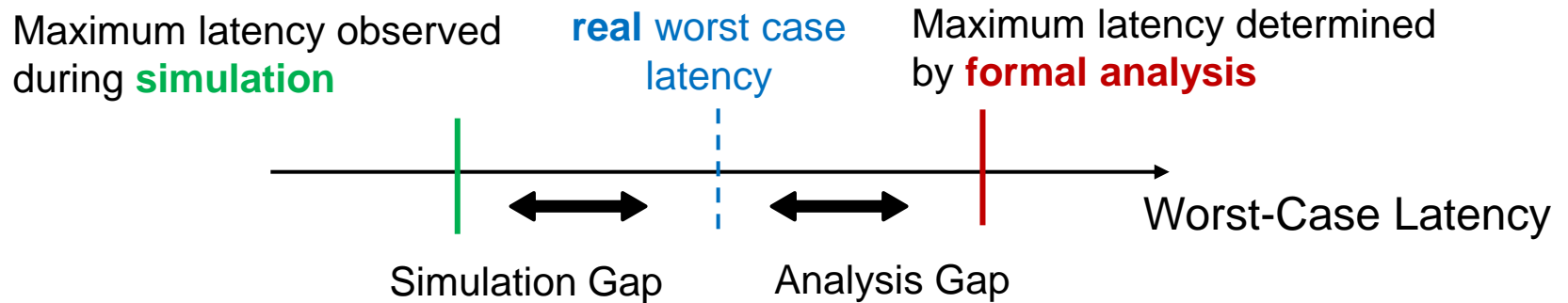

Combining Simulation and Formal Analysis

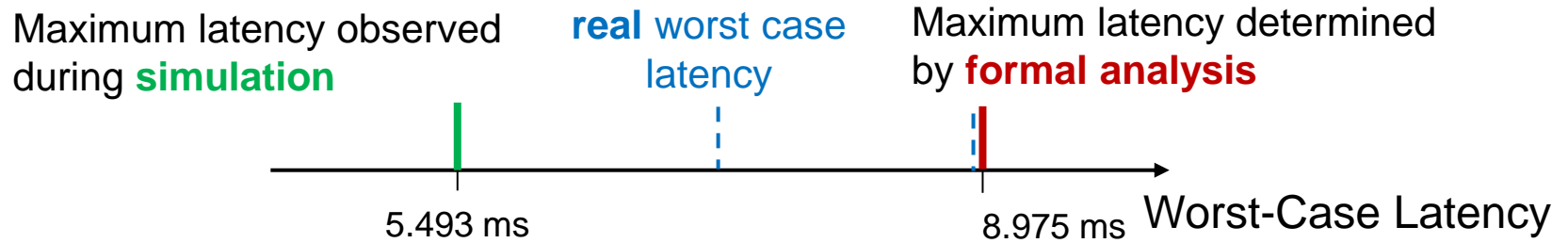

Combining Simulation and Formal Analysis

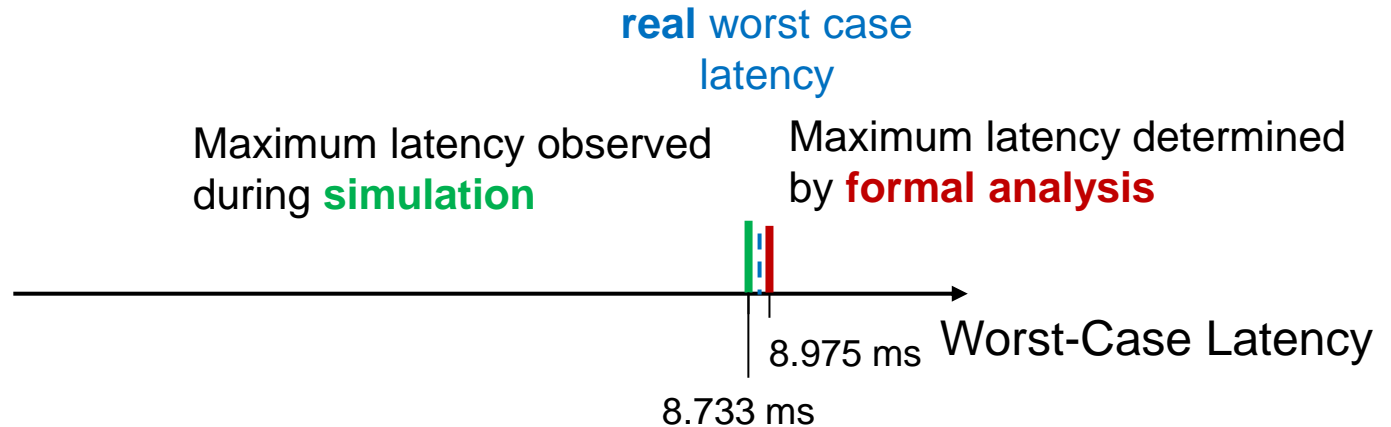

- Changing the simulation parameters a significantly higher latency could be observed in the simulation

Combining simulation and formal analysis allowed us to accurately bound the real worst case Latency

Reasons for Dropped Interference Frames

- Increased burst at the end of IB subnetwork, due to dropped interference frame, possible due to
 - Application jitter: A frame can be missing if the sending device was not fast enough to produce the data on time.
 - Transmission error: A frame can be missing if there was an error during the transmission.
 - Application startup: During application startup, class A/B bandwidth is reserved first, before any data is sent. During this time, the reserved bandwidth is lower than the requested one.
 - Variable bitrate streaming: Variable bit-rate streams by nature exhibit a nondeterministic timing and often send less data than what they have reserved bandwidth for.
 - ...

Some Remarks Regarding the Analysis Results

- CPA of the “Deggendorf” use case took about 100 min, mainly due to
 - Large network
 - Utilization close to 100% (due to the chosen shaping parameters)
 - Non-optimized analysis implementation
- Depending on the network setup, the result of simulation and formal analysis may differ more
- The delay due to the traffic shaper and the blocking by a large NRT frame are the largest contributors to the worst case latency

How to Guarantee Lower Latencies?

1. Reduce blocking due to NRT frames, e.g. by using smaller maximum frame sizes or by making them pre-emptible
 2. Reduce the shaper delay by, e.g. allowing burst of frames to get through
- Compositional performance analysis can easily be adapted to consider these changes
 - Combination of simulation and compositional performance analysis can be used to determine the resulting worst case latencies

SymTA/S 3.0 AVB Analysis Prototype as of 2011

- SymTA/S = Open and extensible scheduling analysis tool suite
- Interface to import analysis algorithms from TUBS
- AVB Data Model and Result Visualization in SymTA/S 3.0
- Commercialization planned in 2012, depending on customer interest

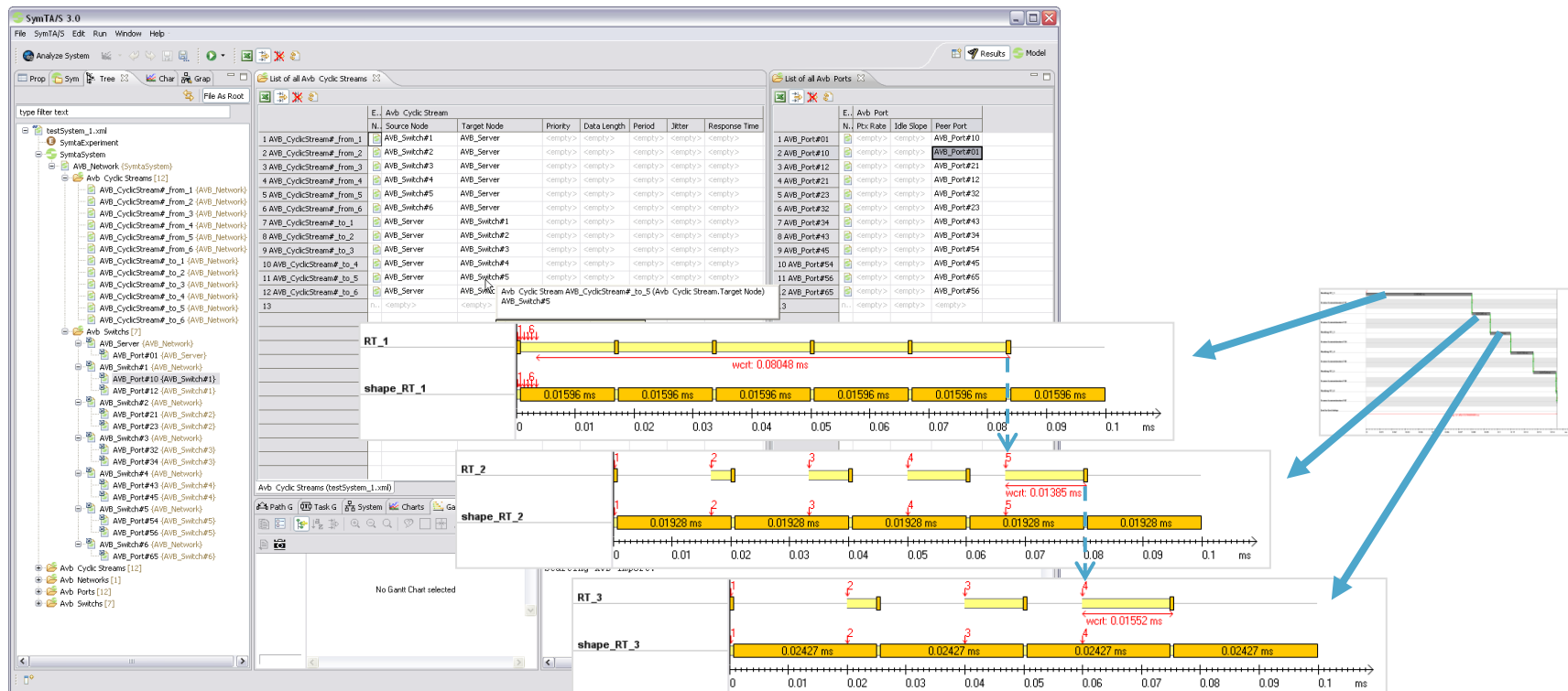

Agenda

- Introduction
- Formal Analysis Approach
- Analysis of the “Deggendorf” Use-Case
- Conclusion

Conclusion

- Compositional performance analysis (CPA) can be used to obtain upper bounds for end-to-end latencies in AVB networks
- CPA helps identifying corner cases which can then be verified by simulation
- To support low latency traffic changes to the scheduling behavior are necessary
 - A combination of simulation and CPA is well suited for evaluating the impact of such changes

THANK YOU FOR YOUR ATTENTION!
QUESTIONS?

{rox|diemer}@ida.ing.tu-bs.de

References

- **[802.1Qav-2009]**: IEEE-SA Standards Board. Virtual Bridged Local Area Networks Amendment 12: Forwarding and Queuing Enhancements for Time- Sensitive Streams. *Technical report, LAN/MAN Standards Committee of the IEEE Computer Society*, December 2009.
- **[Pannell2010AVB]**: *AVB Latency Math*, Don Pannell, November 2010.
<http://www.ieee802.org/1/files/public/docs2010/BA-pannell-latency-math-1110-v5.pdf>
- **[Boiger2011class]**: Class A Latency Issues, Christian Boiger, January 2011.
<http://www.ieee802.org/1/files/public/docs2011/ba-boiger-class-a-latency-issues-0111.pdf>
- **[Boiger2011March]**: Per Hop Worst Case Class A Latency, Christian Boiger, March 2011.
<http://www.ieee802.org/1/files/public/docs2011/ba-boiger-per-hop-class-a-wc-latency-0311.pdf>
- **[Rox2010SAE]**: Rox, J. & Ernst, R. Formal Timing Analysis of Full Duplex Switched Based Ethernet Network Architectures. *SAE World Congress, SAE International, 2010, System Level Architecture Design Tools and Methods (AE318)*