

APPLIED-SCIENCES.NET PRESENTS:

# The Zoetrope



A low-cost, open source wind turbine

February 2011, First Edition

This document (including graphics, layout, text and photos) is released under a Creative Commons Attribution-NonCommercial-NoDerivs 3.0 License



<http://creativecommons.org/licenses/by-nc-nd/3.0>

This document was created using the following software:

Inkscape

<http://www.inkscape.org>

Scribus

<http://www.scribus.net>

Gimp, The GNU Image Manipulation Program

<http://www.gimp.org>

The information presented in this document complies with the Expositus project.



<http://www.applied-sciences.net/library/expositus.php>

# TABLE OF CONTENTS

Introduction	4
Overview	5
List of Materials	6
Tools & Supplies	9
Turbine Design	10
Rotor Design	12
Stator Construction	13
Coil Winding Apparatus	14
Stator Wiring Diagram	15
Stator Bracket/Hub Holder Fabrication	17
Alternator Assembly	18
Final Assembly	20
Acknowledgements	22
Notes & Bibliography	23

# INTRODUCTION

We put this construction guide together so that everyone could benefit from this project. Out of the kindness in our otherwise frigid and steely hearts, we made the guide freely available (yay!). Wind power is a fascinating thing and the intent of the guide is to provide a decent introduction to the concepts and terminology so that you can make a functioning wind turbine of your own.

We designed The Zoetrope (our name for the wind turbine) to be durable, low main-

tenance, low cost and easy to build. Additionally, since this is primarily a construction guide, much aerodynamic and electrical theory has been omitted for the sake of simplicity. The parts list is deliberately thorough, but not obligatory. This is one of those rare instances when creativity is rewarded, because you might think of a substitute part that is better suited to the project than the one we listed. We made every effort to ensure that the parts list contains materials that are commonly available. We have no association with any of the listed vendors; they are there for your convenience.

The guide is divided into sections for organizational purposes, but it would be a good idea to read it completely before beginning the project. Also, you should be familiar with basic hand and power tools and the safe operation thereof. Above all, have fun, be safe and we look forward to seeing more wind turbines around.



# Overview

## TURBINE

- 1. Upper Blade Support
- 2. Blade
- 3. Lower Blade Support

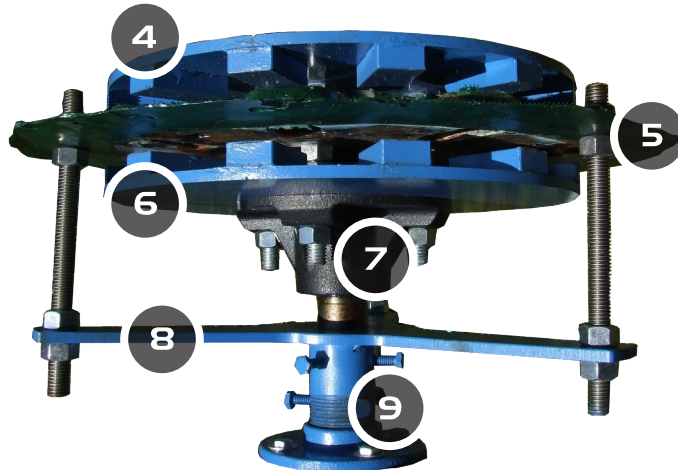

- 4. Upper Magnet Rotor
- 5. Stator
- 6. Lower Magnet Rotor
- 7. Trailer Hub
- 8. Stator Bracket
- 9. Hub Holder

## ALTERNATOR

# LIST OF MATERIALS

## ROTOR

Part	Quantity	Supplier	Notes/Substitutions
Pre-Cut Flat Metal Parts Kit	1	forcefieldmagnets.com	this is a pre-cut kit that includes all the necessary metal parts for the rotor, they are made from 1/4" steel plate that has been cut with a water-jet - <b>substitutions:</b> brake rotors from cars, or have the parts custom made locally using a water-jet cutter
4 on 4 trailer hub	1	local	"4 on 4" means the hub has 4 holes that are on a 4-inch diameter circle around the center; any business that carries trailer parts should have these
2in. x 1in. x 1/2in. neodymium magnets	26	online	only 24 are required; they are very brittle, order extra
1/2in.-13tpi x 3' threaded rod	1	hardware store	TPI (threads per inch) must match the hex nuts
1/2in. hex nuts	16	hardware store	
1/2in. flat washer	4	hardware store	
1/2in. lock washer	4	hardware store	
1/2in.-13tpi hex cap (acorn) nuts	4	hardware store	
1in. metal spacer	4	hardware store	these are used to set the appropriate air gap between the two rotors, small pieces of metal pipe may be substituted, but must be exactly the same length as each other or wobbling will occur

# LIST OF MATERIALS (CONTINUED)

## TURBINE

Part	Quantity	Supplier	Notes/Substitutions
3in. x 60in. galvanized stove pipe	6	hardware store	the stove pipe is sold in sheets and has a snap-together seam along the edges, <b>substitution:</b> galvanized sheet metal (26 gauge)
3/8in. ABS sheet (4ft x 4ft)	1	local	ABS is a type of durable and inexpensive plastic, any plastic sheet with similar properties will suffice - wood is generally not a suitable alternative - marine and boating stores will occasionally carry suitable plastic sheet material
magnets for balancing	as needed	hardware store	if the turbine is unbalanced and wobbles when turning, magnets can be placed on the metal blades to balance the rotation
1/4in. machine screws (3/4in.length)	48	hardware store	
1/4in. flat washers	48	hardware store	
1/4in. lock washers (pack)	48	hardware store	
1/4in. hex nuts (pack)	48	hardware store	
2in. x 5/8in.corner braces	24	hardware store	make sure the 1/4" screws will fit through the holes in the braces
1in. corner braces	12 (optional)	hardware store	if the blades do not hold their shape as desired, small braces can be added
matching screws, washers & nuts for 1in. corner braces	24 (optional)	hardware store	

# LIST OF MATERIALS (CONTINUED)

## STATOR

Part	Quantity	Supplier	Notes/Substitutions
Two Part Epoxy (1 quart) with hardener	1	local	the variety used in this project was TAP Plastics Super Hard Epoxy, most varieties are suitable however
1/4" stainless steel machine screws	3	hardware store	
1/4" stainless steel flat washers	3	hardware store	
1/4" stainless steel hex nuts	3	hardware store	
1/4" ring terminals	3	hardware store	ring terminals are electrical components
1/2"-13tpi x 3' stainless steel threaded rod	1	hardware store	stainless steel is not as ferromagnetic as regular steel and will slow down the turbine less as it rotates
1/2" stainless steel hex nuts	6	hardware store	
glass mat	as needed	hardware store	a.k.a. glass fabric, glass cloth, fibreglas mat, fibreglas - most hardware stores will have it and nearly all boating stores
24 gauge enamel coated magnet wire (approx. 3 pounds needed)	1	online	compare prices, an 11lb. spool is sometimes cheaper than a 7lb. spool - 24 gauge wire is used to make higher voltage stators, thicker wire is required for lower voltage windings

## MOUNTING HARDWARE

Part	Quantity	Supplier	Notes/Substitutions
1/4in. x 3/4in. hex bolts	6	hardware store	used as "set screws" to hold the axle of the trailer hub in place
1-1/4in. pipe flange	1	hardware store	
1-1/4in. galvanized pipe 18in.	1	hardware store	



# TOOLS & SUPPLIES

Part	Quantity	Supplier	Notes/Substitutions
1/2in.-13tpi x 36in. threaded rod	2	hardware store	used to make jacking screws, reusable for other projects
1/2in. hex nuts	8	hardware store	
anemometer	optional	online	for wind speed measurement
1in. aluminum flat stock	1	hardware store	used for additional spacer fabrication, if needed
tap & die	1	hardware store	used for threading holes in the galvanized pipe, also a useful tool to have around
green enamel paint	1	hardware store	for painting the ABS blade supports (color not important)
blue spray enamel paint	1	hardware store	for painting the rotors and other parts (color not important)
multimeter	1	hardware store	very useful for many things including measuring power output and continuity testing
soldering iron	1	hardware store	
solder	as needed	hardware store	
scrap wood	as needed	anywhere	
power drill	1	hardware store	
jig saw with blades for cutting metal	1	hardware store	used to trim turbine blades to desired size, shape blade supports, general cutting - <b>substitution:</b> hacksaw with metal cutting blade, key-hole saw
spring loaded punch	optional	hardware store	useful for starting holes in galvanized metal
particle mask	1	hardware store	wear it when cutting, sanding, filing, painting, breathing
safety glasses	1	hardware store	eye-patches are fine for pirates, you are not a pirate - eyes are irreplaceable
metal file	1	hardware store	
gloves	1	hardware store	cut metal is often sharp, plan accordingly

# TURBINE DESIGN

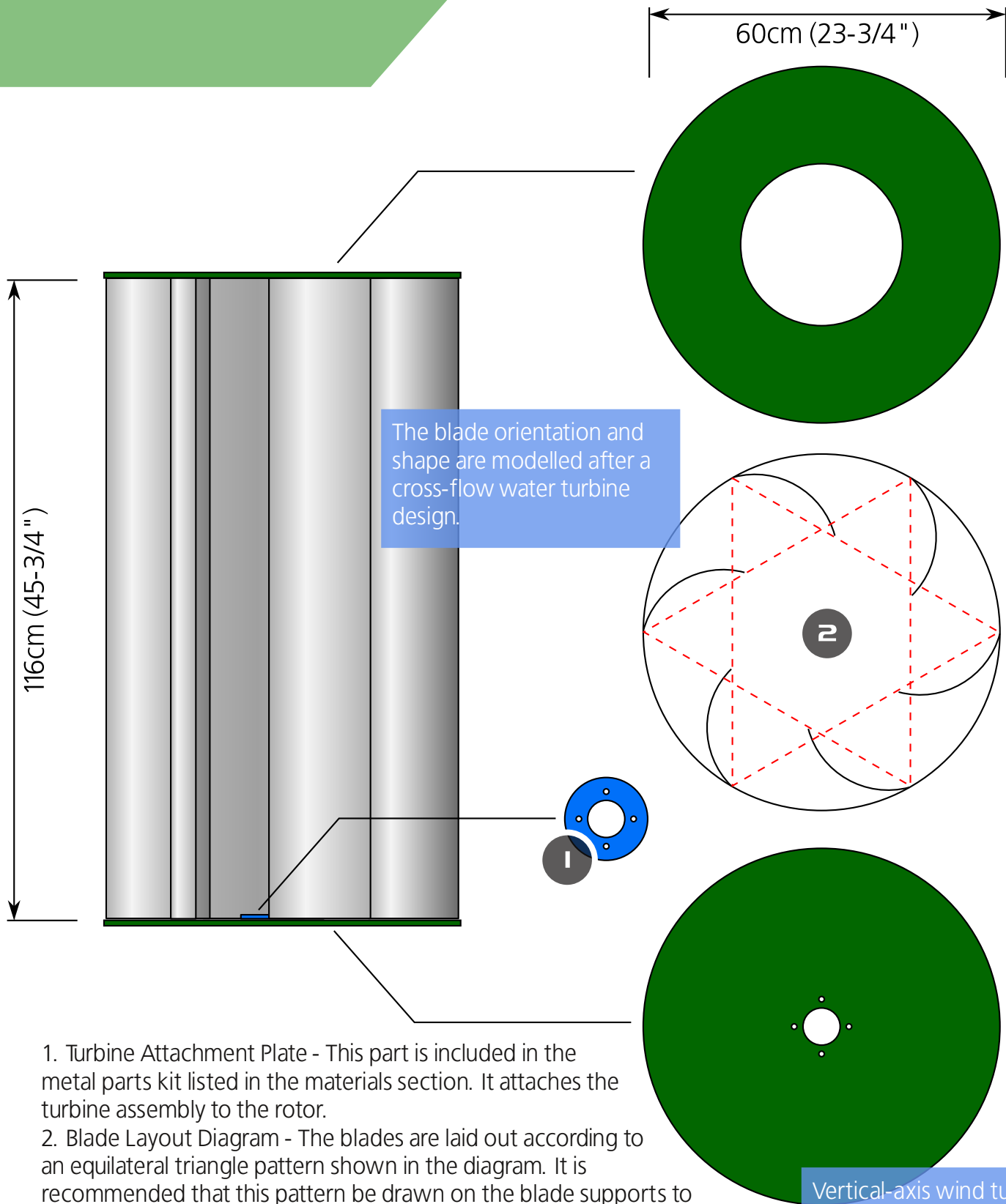

1. Turbine Attachment Plate - This part is included in the metal parts kit listed in the materials section. It attaches the turbine assembly to the rotor.
2. Blade Layout Diagram - The blades are laid out according to an equilateral triangle pattern shown in the diagram. It is recommended that this pattern be drawn on the blade supports to aid in orienting the blades.

Vertical-axis wind turbines are not as efficient as their horizontal counterparts, but are suitable for a wider range of sites.

Fig. 1

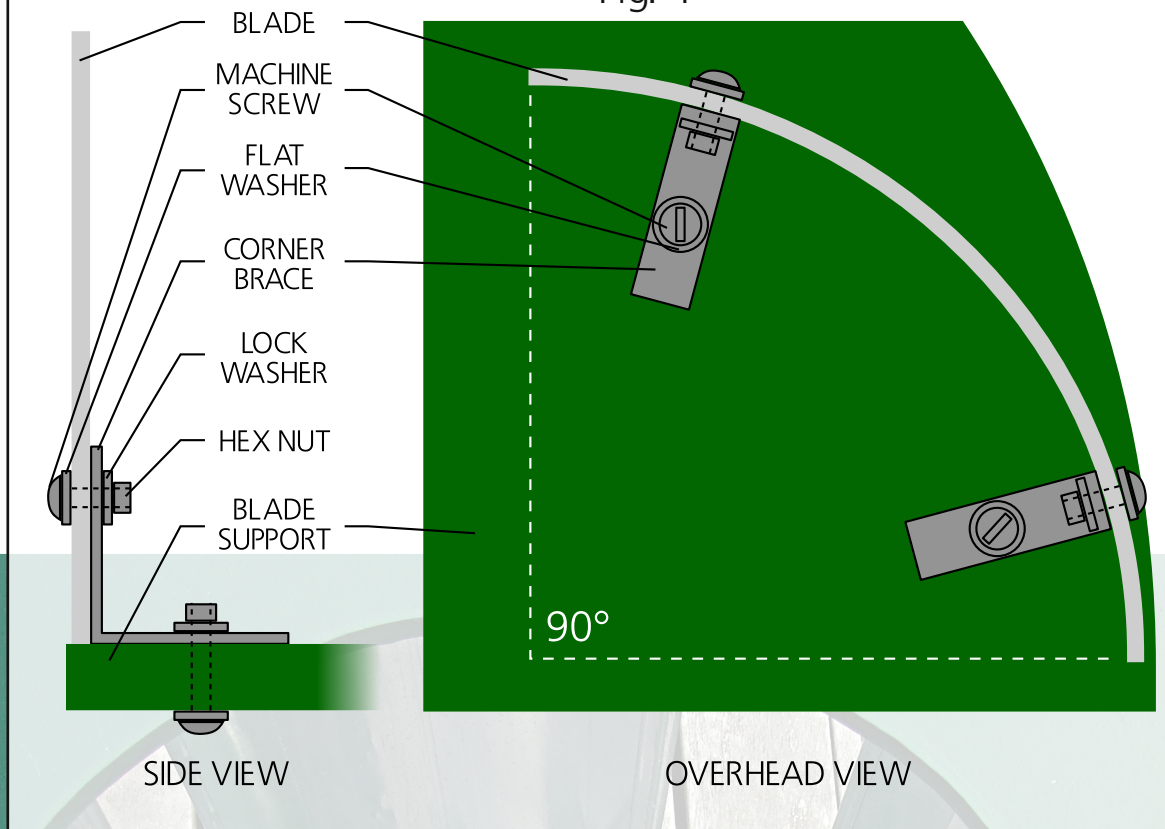

Cardboard templates are a good way to make repeatable marks and shapes. They are also useful in preventing mistakes when cutting or drilling.

PROCESS:

1. Lay out and cut the circular ABS blade supports using a jig saw. The shape can be refined with a file or sandpaper. Stacking the material and cutting both supports at once is a good way to ensure uniformity.
2. Cut a 30cm (12in) hole in the center of one of the blade supports. This will become the upper blade support.
3. Measure and drill appropriate holes in the lower blade support to match the trailer hub.
4. Make a template to shape the blade curvature (see Figure 1) and to mark the holes for the screws that

5. Stack blades evenly and tape securely together. Mark and cut the blades to the desired length. Wear appropriate safety equipment. This turbine uses 116cm (46in) blades. Bigger blades collect more wind, but can become unstable at high speed.
6. Mark and drill the holes in the blades to which the corner braces are attached. A spring-loaded punch is helpful for starting a hole in the metal.
7. Secure the corner braces to the blade supports and the blades to the braces using the pattern shown above.

Strong magnets can be dangerous. They can clamp together with surprising force, even from a large distance.

# Rotor Design

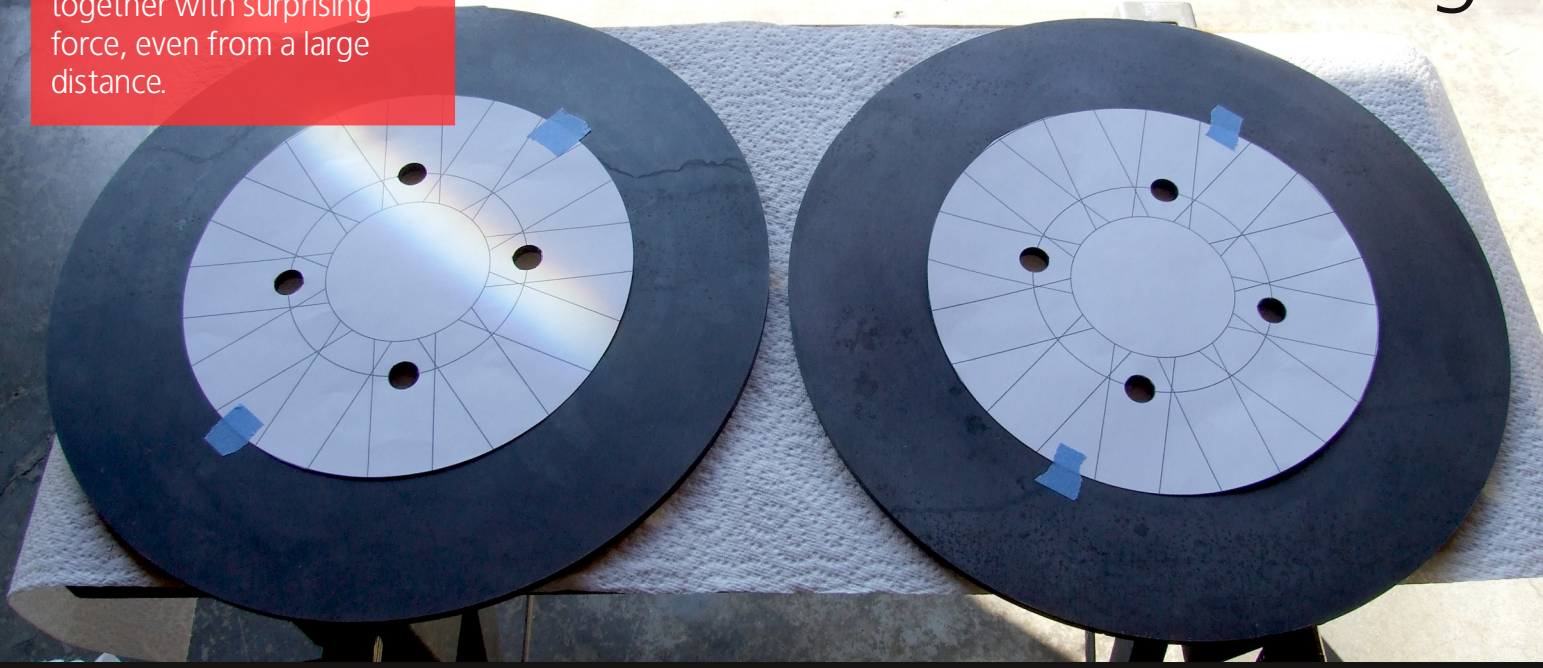

## PROCESS:

1. Align the holes of the plates and use a file to make a very small notch in the side of the plates. This will allow for proper alignment of magnets in the next steps.
2. Make two magnet placement templates like those shown above and tape them to the center of the rotor plates.
3. Mark the polarity of the magnets with a marker. A 'tester' can be made by taping a small, weaker magnet to a popsicle stick and passing it over the larger magnets. The polarity is indicated by whether the tester is attracted or repelled.
4. Clamp the rotor plate down. Mix a small amount of epoxy and apply a pea-sized drop to the underside of the magnet that is to be placed.
5. Following Figure 2, slowly and deliberately move the magnet toward the plate. As the magnet 'grabs' the corner of the plate, slide the magnet into its final position. Placing a magnet straight down from the top will rip the magnet from your grasp and likely break the magnet. Never place any part of your body between the magnet and the rotor plate or between two magnets.
6. Continue placing magnets (with epoxy) around the rotor plate, alternating polarities as you go. A piece of scrap wood between the placed magnet and the one in process can provide insurance against misplaced magnets.

7. Use the same process to attach the magnets to the other plate, but use the alignment notch to ensure all the magnet polarities are opposite.
8. Keep the finished rotors away from each other.

Figure 2

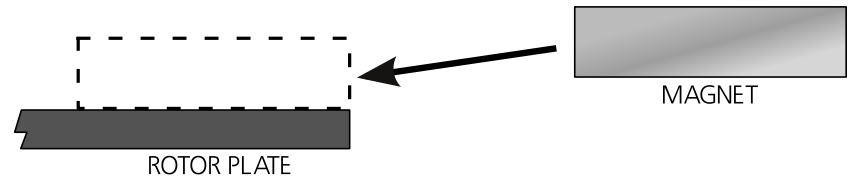

A completed magnet rotor.

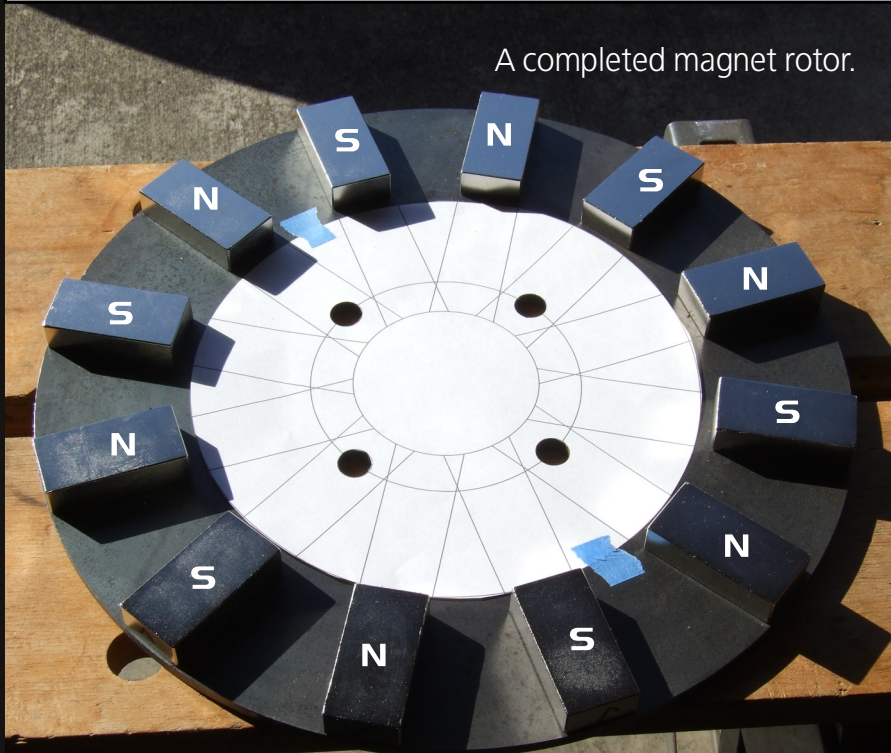

# STATOR CONSTRUCTION

A close-up photograph of a stator winding, showing numerous turns of copper wire. The wire is illuminated from the side, creating a strong orange and red glow that highlights the texture and curvature of the coils. The background is dark and out of focus.

The stator is the most labor intensive part of the wind turbine construction process. It is possible to purchase pre-made stators, but make sure they are good quality and compatible with the rest of the alternator. Because the part is labor-intensive, be prepared to spend a good deal more money for pre-made stators than on parts for home-built ones. Additionally, it is possible to buy the entire alternator pre-made, but it may or may not be suitable for your particular application.

# HOW TO BUILD A Coil Winding Apparatus

SPECIAL SECTION



The stator is an electrical component composed of 9 wire coils like the one shown above. They are divided into three groups of 3 coils and connected in a specific configuration. Each coil has 320 turns of 24 gauge copper wire. A "turn" is one complete cycle around the coil. A high number of turns with thin wire results in a high voltage, low current output. The stator's voltage output should be tailored to the application for which it is to be used. Some helpful approximations are listed below.

320 turns, 24 ga. = 100V @ 120RPM  
160 turns, 16 ga. = 48V @ 140RPM  
60 turns, 15 ga. = 24V @ 120RPM  
(RPM = rotations per minute, since output is related to wind speed)

Winding coils by hand can be tedious and difficult work. Constructing a coil winding apparatus like the one shown is highly recommended. It is made from scrap material since it has a limited life expectancy.

Each coil of the stator must be wound in the same direction, so keep track of which wire is the beginning and which the end. To prevent the finished coils from unwinding, they are taped and coated with two-part epoxy. They are then left to cure (let the epoxy harden) on wax paper.

The coil winding apparatus is made from scrap wood, leftover threaded rod, hex nuts, scrap PVC pipe and nails. Heating the threaded rod before bending prevents breaking.

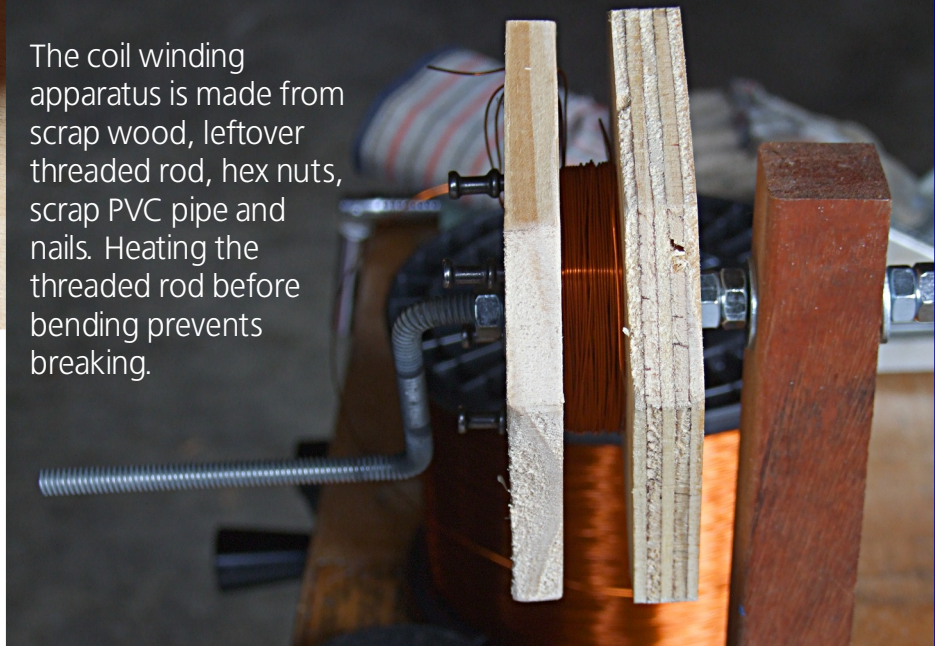

A small length of pipe between the "plates" determines the thickness of the coil. The location of the nails should correspond to the dimensions of your magnets.

The design of the apparatus is not critical. As long as it produces uniform coils when the handle is turned, it should be considered a successful design. A convenient way to test for coil uniformity is to weigh the coils on a scale and check their resistance with a multimeter.

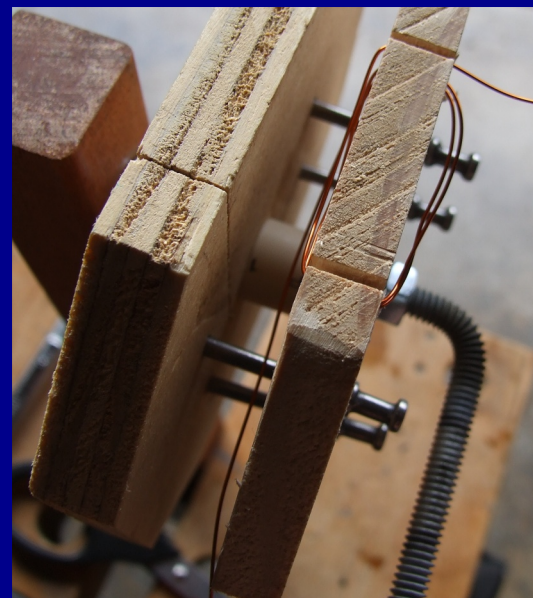

# Stator Wiring Diagram

Do not attempt to power household appliances or electronics directly from the wind turbine's stator. Also, use caution around high voltages.

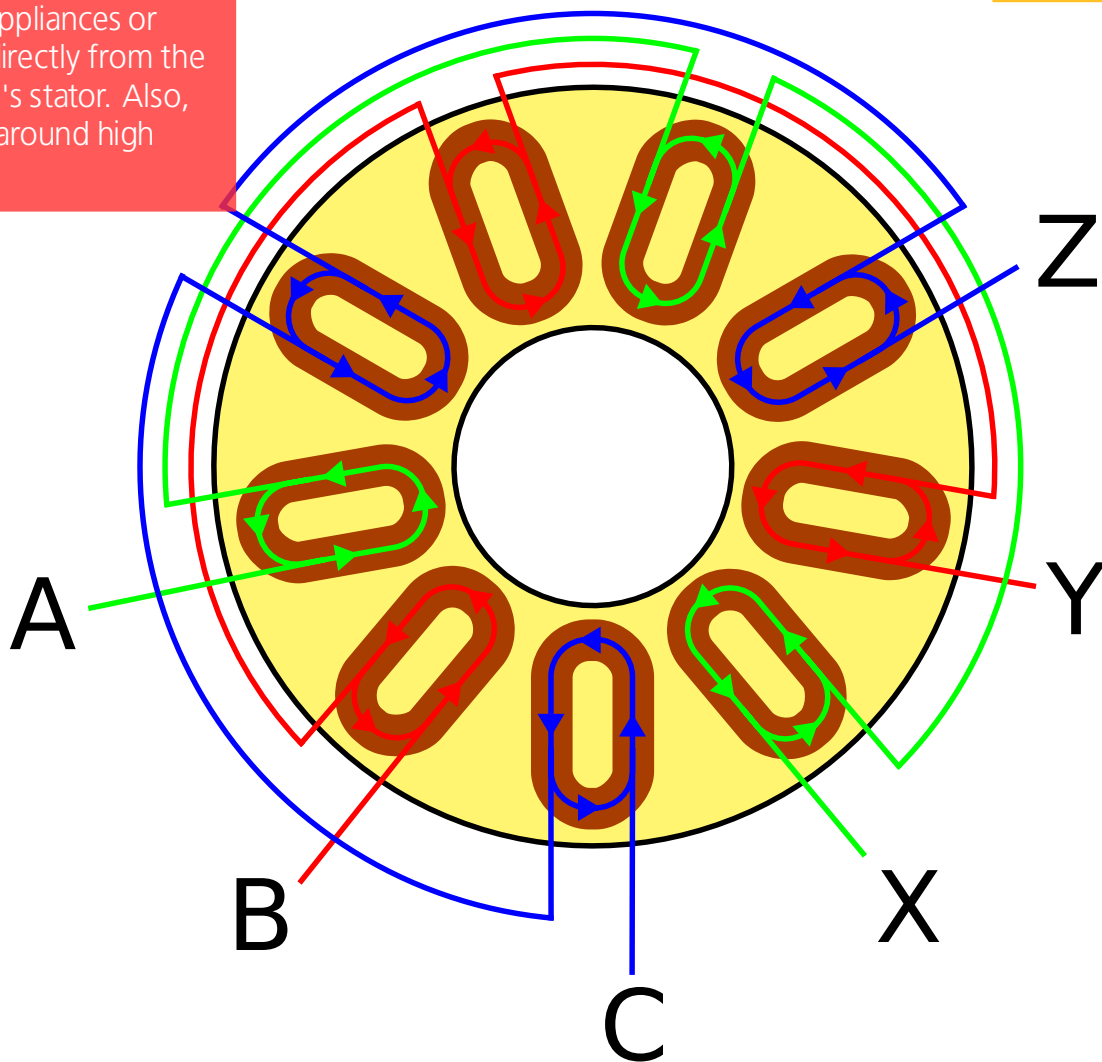

## PROCESS:

1. Strip the insulation from the tips of each wire coil using sandpaper.
2. Connect each coil as shown above to create 3 groups of three coils. This arrangement will create 3-phase AC (alternating current) power. The coils can be spliced together with solder or crimp-on connectors.
3. Choose one configuration from the following:
  - a. For higher voltage output (known as star configuration), connect: X,Y,Z together.
  - b. For higher current output (known as delta configuration), connect: X to B, Y to C, Z to A.
  - c. To be able to change the configuration at will, make sure to leave the leads to A,B,C and X,Y,Z outside the resin when adhering the glass cloth.
4. Make a layout diagram on a large piece of paper. The diagram will allow the coils to be evenly spaced and line up with the magnets on the rotors.
5. Secure the coils in place with tape and mix a small amount (3oz.) of the two-part epoxy according to the instructions on the package.
6. Use a paint brush to dab the epoxy onto the glass cloth. Add more small pieces of glass cloth and epoxy as needed. Leave the center of the coils as free of epoxy and glass cloth as possible to promote cooling of the coils when the turbine is in operation. Try to remove air bubbles that get trapped under the glass cloth/epoxy. The objective of this entire procedure is to provide a flat support and rigid structure to hold the coils in place between the magnet rotors. It is not a load-bearing part.

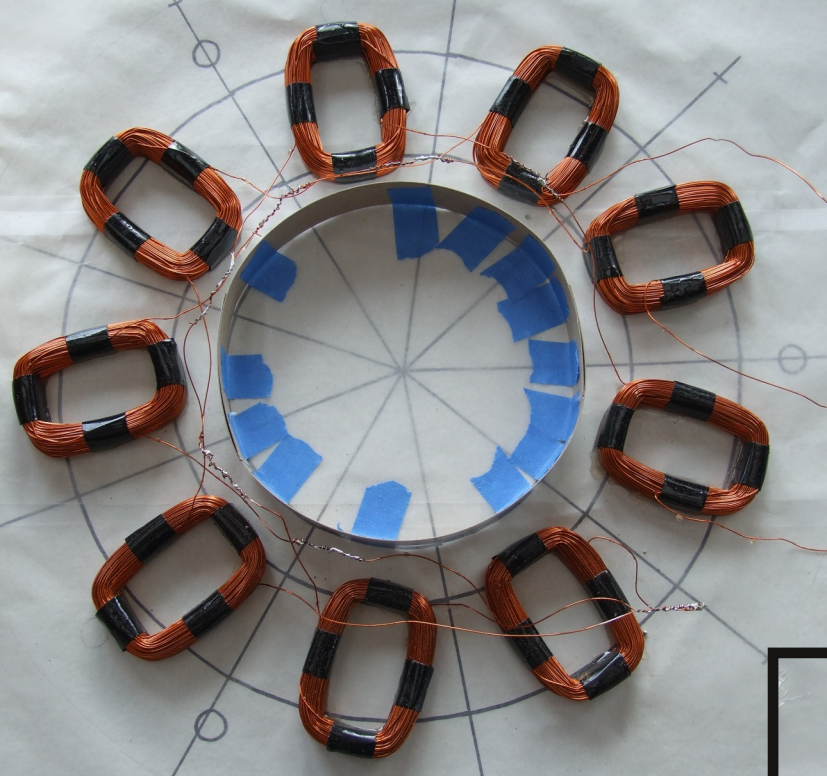

LEFT: The finished coils are laid out onto wax paper with a layout diagram underneath for alignment. The smaller circles at the edge are for the stator bracket holes. A cardstock ring in the center keeps epoxy from flowing to the center. A similar ring around the outer edge would be a good idea as well.

RIGHT: The coils are taped into their final positions. Glass mat is cut into small strips and placed around the coils. The spliced wires can be placed at the inner or outer edge. The leads coming from each phase must be long enough to protrude from the stator by several inches. Now would be a good time to re-check all the connections using a multimeter as they will soon be permanent.

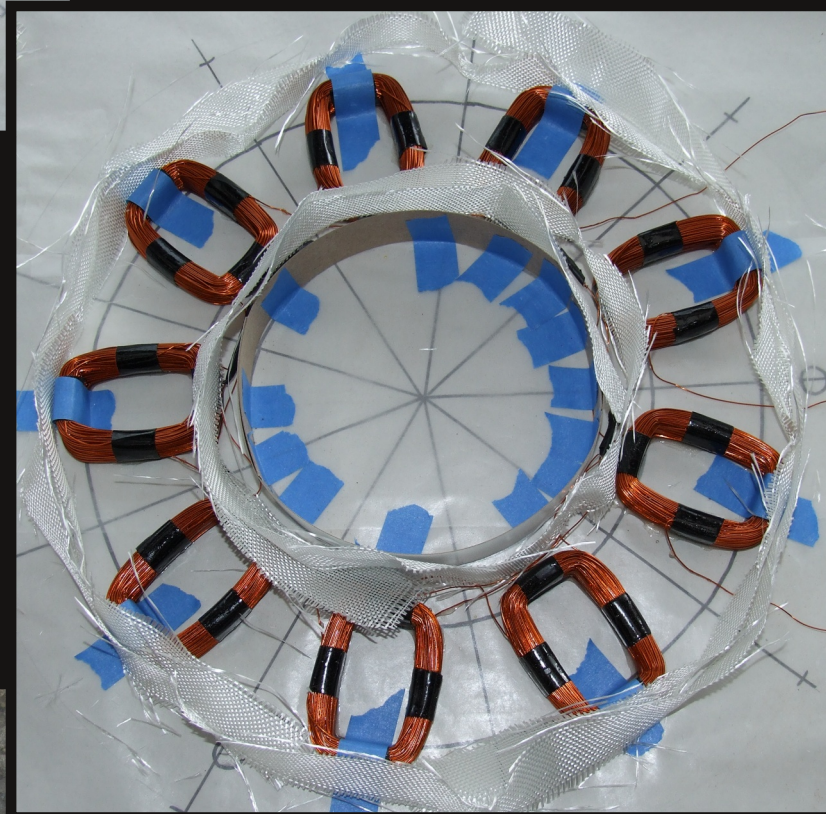

LEFT: The underside of the nearly-complete stator. The stator bracket\* (blue) is placed on top to mark the holes that will be drilled through the stator. Be certain the holes will not sever any wires inside the stator or a new one may be necessary! While wearing a particle mask and goggles, the edges and surface can be trimmed and sanded if desired, but make sure not to affect any wires in the stator.

\*The stator bracket fabrication process is shown on the next page.



# Stator Bracket/Spindle Holder Fabrication

BELOW: A length of galvanized pipe has been cut and drilled to form a holder for the hub spindle (sometimes called the axle). The holes for the set screws were threaded using a tap and die. Tightening the set screws will hold the spindle firmly in place. (This is the underside of the stator bracket/spindle holder.)



A tap and die is a set of tools that are used to cut screw threads into a hole or onto a rod.

LEFT: The bracket which holds the stator between the rotors. After the length of galvanized pipe has been cut and drilled, it is glued to the bracket using epoxy. Gluing metal can be problematic, but by making sure the surfaces are free of rust, oil and debris, a satisfactory bond can be achieved. An

epoxy with a metal filler (such as JB-Weld) can help to avoid problems caused by thermal expansion and contraction.

# Spacer Assembly Fabrication

ABOVE: 1/2in. hex nuts are used to hold the non-threaded metal spacers in place. They also provide a way to increase or decrease the air gap in large increments. The air gap is the distance between the magnet rotors.



A completed spacer assembly. 4 of these units will keep the magnet rotors apart and correctly positioned around the stator. Your spacer assemblies may have a different number of hex nuts and other spacing material depending on the thickness of your stator.

BELOW: Optional aluminum spacers made from 1in. wide, 1/8in. thick aluminum bar stock. These are used to increase the air gap in small increments and are more uniform than flat washers.



# Final Assembly: Alternator

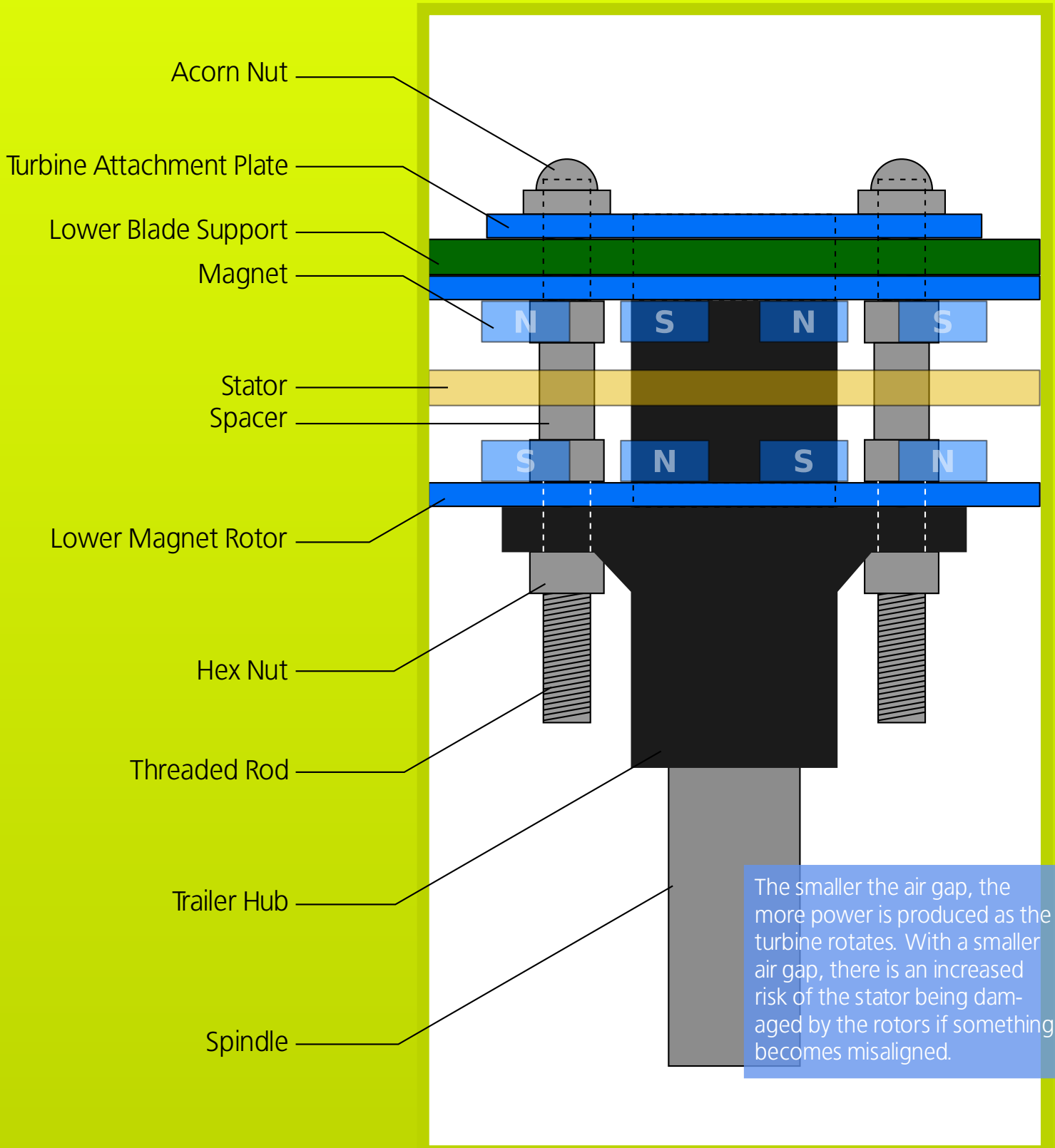

ABOVE: A simplified side-view diagram of the alternator. The magnets and stator have been made partially transparent to allow viewing of the internal structure.

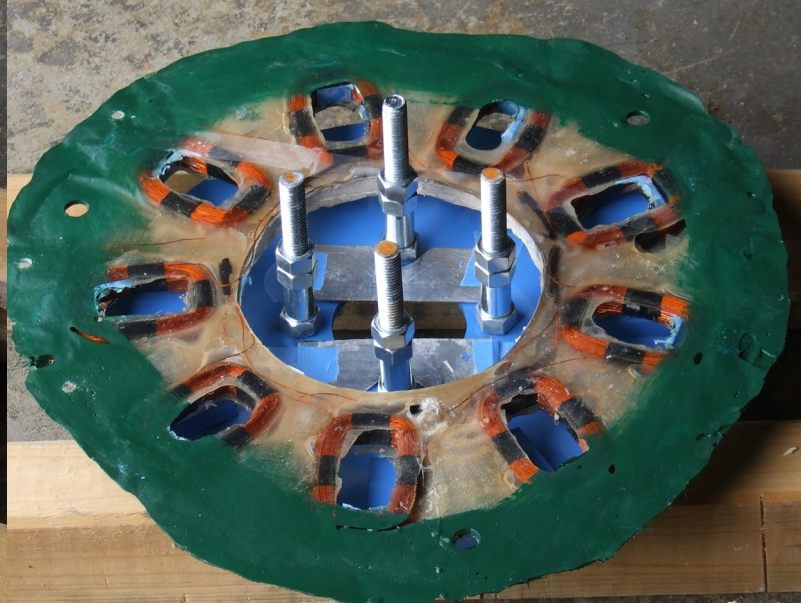
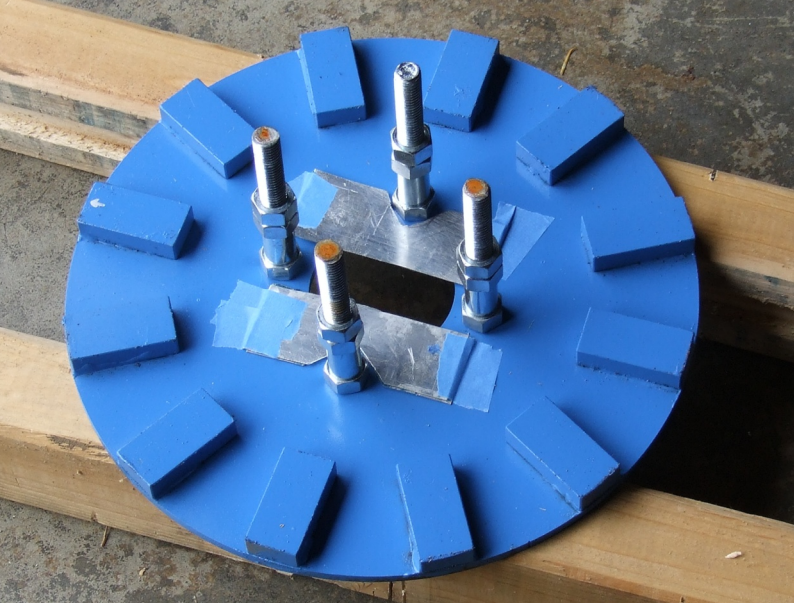

ABOVE LEFT: A finished magnet rotor with 4 spacer assemblies and 2 aluminum bearing plates attached. The aluminum plates are temporary and will be removed with the jacking screws.

ABOVE RIGHT: The finished stator (now painted green to protect it from the elements) is put in place.

1. With the bottom rotor secured, CAREFULLY lower the upper rotor, using the jacking screws as a handle, until the jacking screws rest on the aluminum plates.

The rotors will be attracted to each other with considerable force. Use the alignment notches you made earlier to align the rotors.

2-4. Turn each jacking screw a few turns at a time to slowly bring the plates together.

5. With the rotors now resting on the spacers, remove the jacking screws and bearing plates.

6. Place the trailer hub onto the rotor and secure with hex nuts.

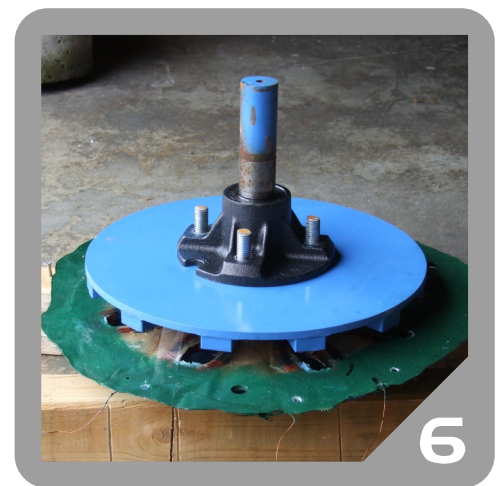
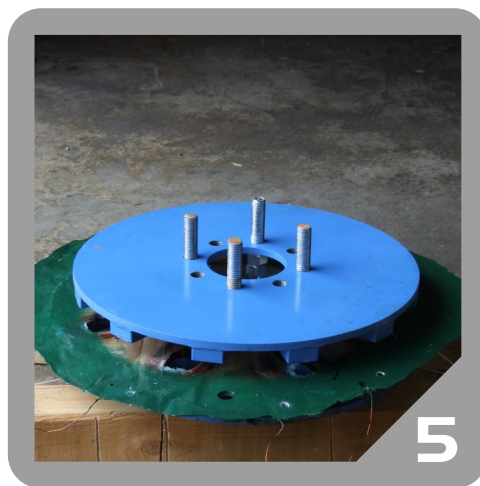
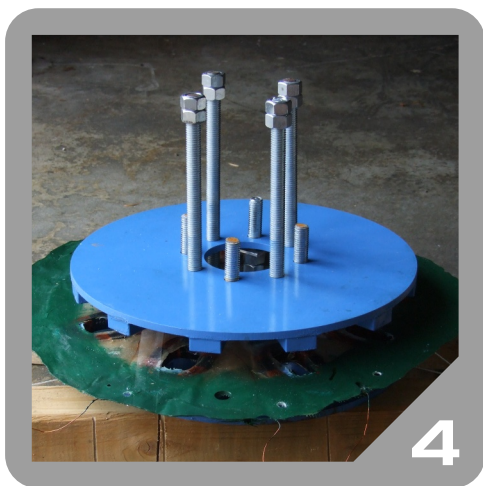
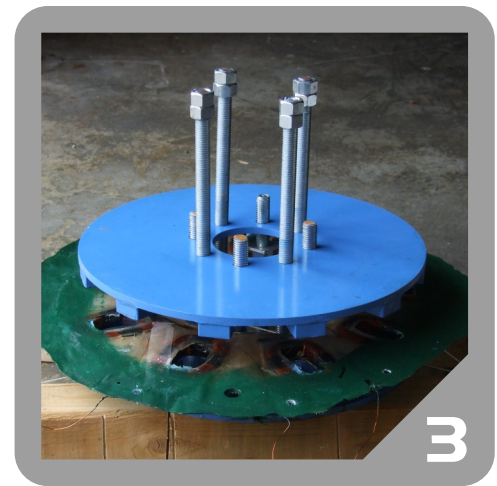
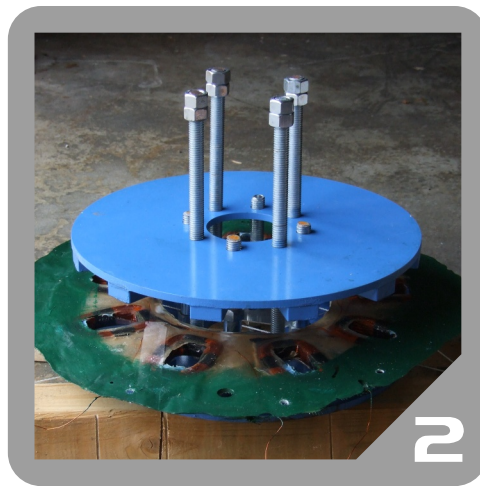
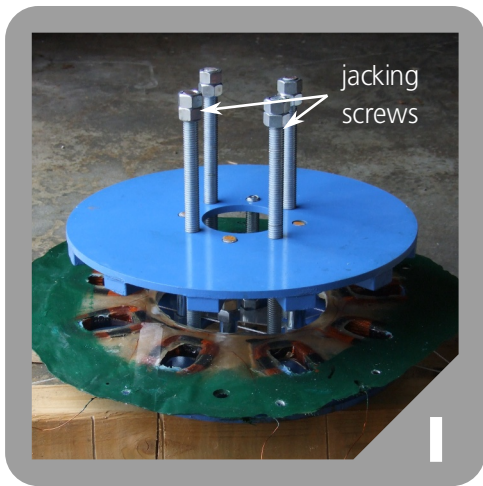

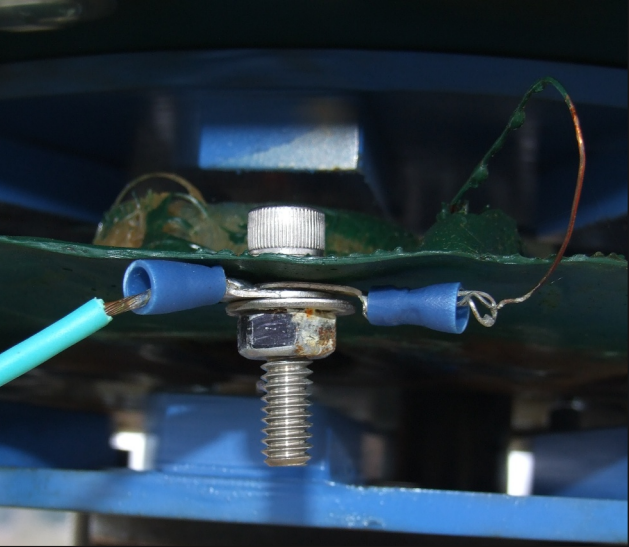

ABOVE: Stainless steel screws are used as binding posts for the electrical connections on the stator. When drilling holes for the binding posts, make sure to avoid hitting any wires in the stator. Ring terminals have been crimped on to the stripped ends of the stator wires and the power transmission wire.



ABOVE: With the addition of some stainless steel threaded rod (1) and a pipe flange (2), your alternator should look like this one. NOTE: Lock washers were later added to the hex nuts at the bottom of the trailer hub.

**W**ith assembly complete, it is possible to test the alternator by spinning it manually and measuring the voltage. Notice that if all three ring terminals are shorted (connected together), the alternator becomes difficult to turn. This can be advantageous if the turbine needs to be stopped for service or safety.

Even though the alternator is now producing electrical power, it may not be in a useful form for a chosen application. The Zoetrope, for instance, was intended for supplementary water heating so the stator was wound to produce a higher voltage that the heating elements could utilize. For an application such as battery charging, a much lower voltage output would be desirable. The power emanating from the alternator described in this document is 3-phase AC with varying voltage and frequency (they vary with wind speed). By contrast, the power system used in North America is single-phase AC, 120-volt, 60Hz. There is no convenient way to convert one system directly to the other, but that does not mean the turbine is useless. The turbine's power can be "rectified" to form direct current (DC) power. Direct current can be used to power lights, heat water, charge batteries, split water into hydrogen, even converted back to AC to run household appliances. Those applications are beyond the scope of this guide, however.

BELOW: Acorn nuts and some flat washers are used to fasten the turbine mounting plate (and the turbine) to the alternator. The wind turbine is now completely assembled and ready for testing.



## Attachment and Location

The wind turbine shown in this document was mounted atop a 4-meter steel pole and located at the edge of a cliff. The pipe flange that forms the bottom of the hub holder provides a convenient way to securely attach the turbine to a supporting structure using 4 screws or bolts. The turbine can be subjected to considerable force in gusts of high wind, so the structure should be very stable and the screws/bolts strong enough for a secure hold.

Conventional windmill-type horizontal wind turbines require that the wind be predominantly blowing from one direction for optimal performance, but vertical-axis wind turbines are capable of harvesting wind from any direction. This property makes them suitable for more sites despite lower overall efficiency. The Zoetrope is located on a site that receives highly turbulent wind from almost any direction, conditions that are not particularly suitable for a horizontal-axis wind turbine.

Another factor that is important to consider when siting any wind turbine is average wind speed. Local wind speed averages are easy to obtain on the internet, but they usually do not tell you the average at your location. An anemometer (wind speed measuring device) can be useful in determining if and where a turbine should be placed.

## Simplified Wind Turbine Mechanics

Wind is created by temperature differences on the surface of the earth. As wind hits the blades of this wind turbine, it has three effects: lift, drag and impulse. Lift is produced from airflow over a curved surface and the resulting pressure difference that occurs. Since the blades are attached to a rigid substrate which is in turn attached to a trailer hub, the blades end up "lifting" themselves in a circle. Drag is an unwanted force that occurs as the blade surface moves into the oncoming wind and

must displace the air molecules in its path. Drag slows the turbine down. Impulse occurs at the concave side of the blades. Once the air molecules hit the back of the blades, they have nowhere to go as more air collects behind it. As a result, the blade is pushed in the direction of the wind. The more wind that hits the blade, the faster it will move, but only up to the speed of the wind itself. By maximizing lift and impulse and minimizing drag, the turbine is made to rotate. As the turbine turns, so does the rotor. The magnets on the rotor create an alternating magnetic field through the center of the coils which are embedded in the stator. This alternating magnetic field induces electrical current in the wires of the coils. Those wires then carry electricity to its destination.

BELOW: The forces which cause the wind turbine to rotate.

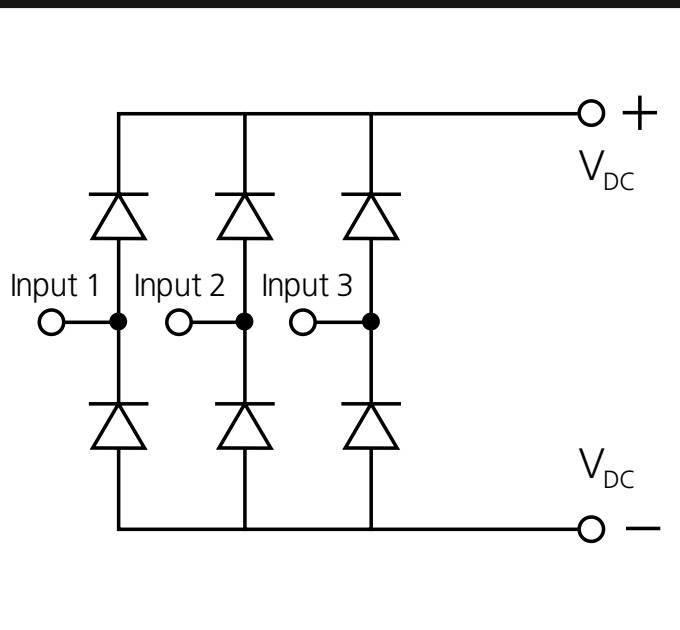

ABOVE: A 3-phase bridge rectifier composed of six individual diodes for converting AC to DC. The three wires from the stator can be hooked up to the three inputs. DC power is then available at +/-.

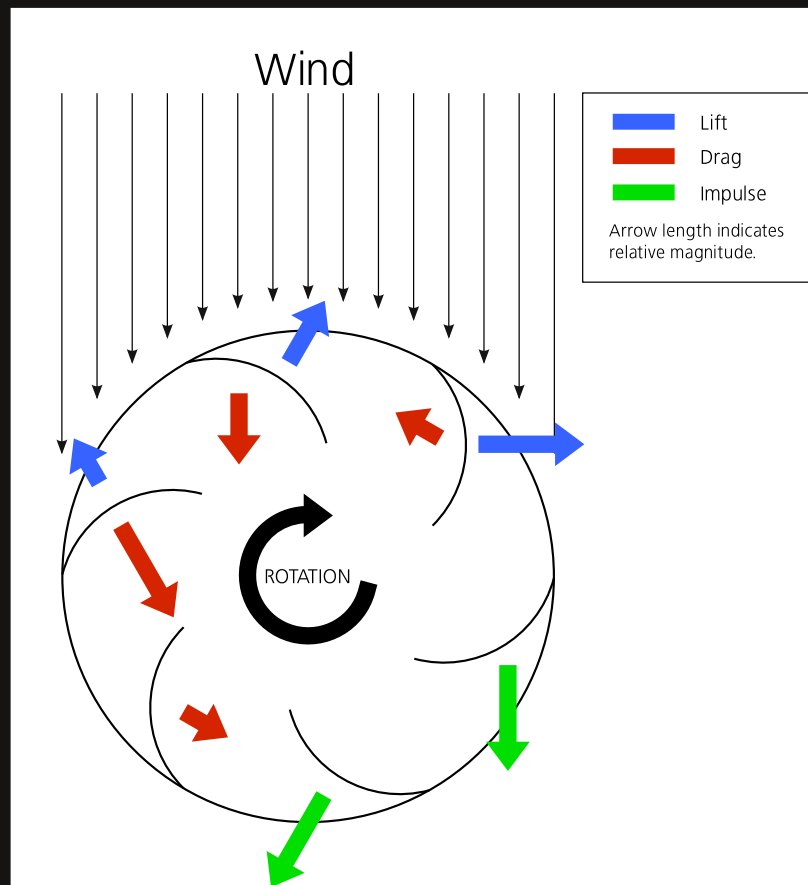

# Acknowledgements

Applied Sciences would like to thank Mike Marohn for funding this project and for being committed to renewable energy even amidst trying economic conditions. We would also like to thank the following entities for their help on the wind turbine and the construction guide.

*Vinz Fredrix*

vinzfredrix.com

design, layout, technical drawing,  
diagrams & figures

*G.V.C. - U.S.M.C. Ret.*

tower fabrication, design advice,  
tower material donation

*Kelly Golob*

kellygolob.com

editing supervisor

*Melanie Golob*

supervising editor

*Ross Jarvis* P.E.

tower assembly

*Larry Blume*

tower transport

**McGimpsey Construction**

material transport

*Olivia Boots*

translator



## Notes

- The wind turbine originally had blades made from 12" PVC pipe. The pipe proved to be exceedingly heavy. The PVC blades were epoxied onto the ABS blade supports. That was a bad idea that resulted in the turbine falling apart during transport.
- Ask around before buying your materials. Chances are good that you can get some materials for free from friends, family, neighbors, people that live out in the county...
- The ABS plastic blade supports are the most expensive component of the entire project.
- There are parts of the guide that reference the way we did things for this particular project, but would probably not be applicable to other people's needs. An example of this would be the stator winding. We needed a high voltage to work with our heating elements, but most people will probably be using their wind turbine for battery charging or connected to a charge controller. In those cases, a lower voltage is required.
- The Zoetrope uses a multi-stage load circuit to gradually increase the load on the turbine as wind speed increases. A good charge controller or wind speed controller should have a similar function. By using multiple stages for loading, power can be generated as soon as the turbine starts spinning. By contrast, single stage loading circuits may not allow the turbine to spin at all in low wind.
- The name of the turbine comes from an early animation device that used a rotating cylinder with slits in the side to give the illusion of moving pictures. At certain speeds, the wind turbine gives a similar effect.
- There are two sure ways to get more power out of a wind turbine: 1. find higher wind speeds 2. get bigger blades (larger swept area).
- Some states, provinces and countries offer incentives like refunds and tax breaks for alternative energy systems.

## Bibliography

**Otherpower.com** - This entire site is a useful resource for renewable/alternative energy.

**Small Scale Renewable Energy Control Systems** - Brent Crowhurst, Renewable Energy Program Coordinator, Falls Brook Centre, New Brunswick, Canada (it would have been awesome to find the load controller schematic on page 7 *before* designing the one used on The Zoetrope, which is nearly identical)

**Delmar's Standard Textbook of Electricity 3<sup>rd</sup> Edition** - Stephen Herman

**The Art of Electronics 2<sup>nd</sup> Edition** - Horowitz & Hill

**Windstuffnow.com**