

# MEF

## Technical Specification

### MEF 6.1

### Ethernet Services Definitions - Phase 2

**April, 2008**

**MEF 6.1**

© The Metro Ethernet Forum 2008. Any reproduction of this document, or any portion thereof, shall contain the following statement: "Reproduced with permission of the Metro Ethernet Forum." No user of this document is authorized to modify any of the information contained herein.

### **Disclaimer**

The information in this publication is freely available for reproduction and use by any recipient and is believed to be accurate as of its publication date. Such information is subject to change without notice and the Metro Ethernet Forum (MEF) is not responsible for any errors. The MEF does not assume responsibility to update or correct any information in this publication. No representation or warranty, expressed or implied, is made by the MEF concerning the completeness, accuracy, or applicability of any information contained herein and no liability of any kind shall be assumed by the MEF as a result of reliance upon such information.

The information contained herein is intended to be used without modification by the recipient or user of this document. The MEF is not responsible or liable for any modifications to this document made by any other party.

The receipt or any use of this document or its contents does not in any way create, by implication or otherwise:

- (a) any express or implied license or right to or under any patent, copyright, trademark or trade secret rights held or claimed by any MEF member company which are or may be associated with the ideas, techniques, concepts or expressions contained herein; nor
- (b) any warranty or representation that any MEF member companies will announce any product(s) and/or service(s) related thereto, or if such announcements are made, that such announced product(s) and/or service(s) embody any or all of the ideas, technologies, or concepts contained herein; nor
- (c) any form of relationship between any MEF member companies and the recipient or user of this document.

Implementation or use of specific Metro Ethernet standards or recommendations and MEF specifications will be voluntary, and no company shall be obliged to implement them by virtue of participation in the Metro Ethernet Forum. The MEF is a non-profit international organization accelerating industry cooperation on Metro Ethernet technology. The MEF does not, expressly or otherwise, endorse or promote any specific products or services.

© The Metro Ethernet Forum 2008. All Rights Reserved.

**MEF 6.1**

© The Metro Ethernet Forum 2008. Any reproduction of this document, or any portion thereof, shall contain the following statement: "Reproduced with permission of the Metro Ethernet Forum." No user of this document is authorized to modify any of the information contained herein.

# Table of Contents

<b>1. ABSTRACT .....</b>	<b>1</b>
<b>2. TERMINOLOGY .....</b>	<b>1</b>
<b>3. SCOPE.....</b>	<b>6</b>
3.1 SCOPE OF FUTURE PHASES .....	6
<b>4. COMPLIANCE LEVELS.....</b>	<b>7</b>
<b>5. INTRODUCTION .....</b>	<b>7</b>
<b>6. ETHERNET SERVICE DEFINITION FRAMEWORK (NORMATIVE) .....</b>	<b>7</b>
6.1 ETHERNET LINE (E-LINE) PHASE 2 SERVICE TYPE .....	9
6.2 ETHERNET LAN (E-LAN) SERVICE TYPE .....	11
6.3 ETHERNET TREE (E-TREE) SERVICE TYPE.....	14
<b>7. SERVICE DEFINITIONS (NORMATIVE) .....</b>	<b>16</b>
7.1 ETHERNET PRIVATE LINE SERVICE.....	17
7.2 ETHERNET VIRTUAL PRIVATE LINE SERVICE .....	19
7.3 ETHERNET PRIVATE LAN SERVICE .....	22
7.4 ETHERNET VIRTUAL PRIVATE LAN SERVICE.....	25
7.5 ETHERNET PRIVATE TREE SERVICE.....	28
7.6 ETHERNET VIRTUAL PRIVATE TREE SERVICE.....	31
<b>8. LAYER 2 CONTROL PROTOCOL PROCESSING REQUIREMENTS (NORMATIVE) .....</b>	<b>33</b>
8.1 L2CP REQUIREMENTS FOR ETHERNET PRIVATE LINE (EPL) SERVICE .....	34
8.2 L2CP REQUIREMENTS FOR ETHERNET VIRTUAL PRIVATE LINE (EVPL) SERVICE .....	35
8.3 L2CP REQUIREMENTS FOR ETHERNET PRIVATE LAN (EP-LAN) SERVICE.....	35
8.4 L2CP REQUIREMENTS FOR ETHERNET VIRTUAL PRIVATE LAN (EVP-LAN) SERVICE.....	36
8.5 L2CP REQUIREMENTS FOR ETHERNET PRIVATE TREE (EP-TREE) SERVICE .....	36
8.6 L2CP REQUIREMENTS FOR ETHERNET VIRTUAL PRIVATE TREE (EVP-TREE) SERVICE .....	37
<b>9. SERVICE OAM REQUIREMENTS (NORMATIVE) .....</b>	<b>38</b>
9.1.1 Subscriber MD, Continuity Check.....	39
9.1.2 Subscriber MD, Link Trace .....	39
9.1.3 Subscriber MD, Loopback.....	40
<b>10. REFERENCES .....</b>	<b>41</b>
<b>11. APPENDIX A: MEF AND IEEE 802.1 TERMINOLOGY (INFORMATIVE).....</b>	<b>42</b>
<b>12. APPENDIX B: PRACTICAL EXAMPLES OF ETHERNET SERVICES (INFORMATIVE).....</b>	<b>42</b>
12.1 EXAMPLE: A TRANSPORT-ORIENTED ETHERNET PRIVATE LINE (EPL) SERVICE FOR PRIVATE DATA NETWORKING APPLICATIONS.....	44
12.2 EXAMPLE OF A PACKET-ORIENTED ETHERNET PRIVATE LINE SERVICE FOR PUBLIC DATA NETWORKING APPLICATIONS.....	47
12.3 EXAMPLE: ETHERNET PRIVATE TREE (EP-TREE) SERVICE FOR VIDEO BROADCAST.....	49
12.4 EXAMPLE: DISTANCE LEARNING (EVP-TREE) AND BUSINESS DATA (EVP-LAN).....	51

## List of Figures

Figure 1: Ethernet Service Definition Framework.....	8
Figure 2: E-Line Service type using Point-to-Point EVC.....	10
Figure 3: E-LAN Service type using Multipoint-to-Multipoint EVC.....	12
Figure 4: E-Tree Service type using Rooted-Multipoint EVC.....	14
Figure 5: E-Tree Service type using Multiple Roots.....	15
Figure 6: Ethernet Private Line (EPL) Service.....	17
Figure 7: Ethernet Virtual Private Line (EVPL) Service.....	20
Figure 8: Ethernet Private LAN (EP-LAN) Service.....	23
Figure 9: Ethernet Virtual Private LAN (EVP-LAN) Service.....	26
Figure 10: Ethernet Private Tree (EP-Tree) Service.....	28
Figure 11: Ethernet Virtual Private Tree (EVP-Tree) Service.....	31
Figure 12: Example of Transport-Oriented Private Data Network Interconnect Using the EPL Service.....	45
Figure 13: Example of Transport-Oriented Public Data Network Interconnect Using the EPL Service.....	47
Figure 14: Example of Video Broadcast Delivery Using the EP-Tree Service.....	50
Figure 15: Example of Distance Learning and Business Data Using EVP-LAN and EVP-Tree Services.....	52

## List of Tables

Table 1: Terminology and Definitions Table.....	6
Table 2: Ethernet Services.....	8
Table 3: UNI service attributes and parameter values for all service types.....	9
Table 4: E-Line Service type EVC per UNI service attributes and parameter values.....	11
Table 5: E-Line Service type EVC service attributes and parameter values.....	11
Table 6 : E-LAN Service type EVC per UNI service attributes and parameter values.....	13
Table 7: E-LAN Service type EVC service attributes and parameter values.....	14
Table 8 : E-Tree Service type EVC per UNI service attributes and parameter values.....	16
Table 9: E-Tree Service type EVC service attributes and parameter values.....	16
Table 10: UNI service attributes and parameters for the EPL service.....	18
Table 11: EVC per UNI service attributes and parameters for the EPL service.....	18
Table 12: EVC service attributes and parameters for the EPL service.....	19
Table 13: Differences in EPL from EPL in MEF 6.....	19
Table 14: UNI service attributes and parameters for EVPL service.....	21
Table 15: EVC per UNI service attributes and parameters for EVPL service.....	21
Table 16: EVC service attributes and parameters for the EVPL service.....	22
Table 17: Differences in EVPL from EVPL in MEF 6.....	22
Table 18: UNI service attributes and parameters for the EP-LAN service.....	24
Table 19: EVC per UNI service attributes and parameters for the EP-LAN service.....	24
Table 20: EVC service attributes and parameters for the EP-LAN service.....	25
Table 21: UNI service attributes and parameters for the EVP-LAN service.....	26
Table 22: EVC per UNI service attributes and parameters for the EVP-LAN service.....	27
Table 23: EVC service attributes and parameters for the EVP-LAN service.....	28
Table 24: UNI service attributes and parameters for the EP-Tree service.....	29
Table 25: EVC per UNI service attributes and parameters for the EP-Tree service.....	30
Table 26: EVC service attributes and parameters for the EP-Tree service.....	31

Table 27: UNI service attributes and parameters for the EVP-Tree service.....	32
Table 28: EVC per UNI service attributes and parameters for the EVP-Tree service.....	32
Table 29: EVC service attributes and parameters for the EVP-Tree service.....	33
Table 30: List of Standardized Layer 2 Control Protocols .....	33
Table 31: L2CP Processing Requirements for the EPL Service.....	35
Table 32: L2CP Processing Requirements for the EVPL Service.....	35
Table 33: L2CP Processing Requirements for the EP-LAN Service.....	36
Table 34: L2CP Processing Requirements for the EVP-LAN Service.....	36
Table 35: L2CP Processing Requirements for the EP-Tree Service.....	37
Table 36: L2CP Processing Requirements for the EVP-Tree Service.....	37
Table 37: MEF and IEEE 802.1 terms for L2CP Processing Options.....	42
Table 38: EVC Performance Attributes and Parameters per CoS Offering.....	43
Table 39: L2CP Attribute and Parameters per Service Offering.....	44
Table 40: UNI attributes for the Private Data Networking example using EPL Service.....	45
Table 41: EVC per UNI attributes for the private data networking example using EPL Service.....	46
Table 42: EVC service attributes for the private data networking example using the EPL Service.....	46
Table 43: UNI attributes for the Private Data Networking example using EPL Service.....	48
Table 44: EVC per UNI attributes for the public data networking example using EPL Service.....	48
Table 45: EVC service attributes for the public data networking example using the EPL Service.....	49
Table 46: UNI attributes for the video broadcast example using EP-Tree Service.....	50
Table 47: EVC per UNI attributes for the video broadcast example using EP-Tree Service.....	51
Table 48: EVC service attributes for the video broadcast example using EP-Tree Service.....	51
Table 49: UNI attributes for the distance learning, business data example.....	52
Table 50: EVC per UNI attributes for the distance learning, business data example.....	53
Table 51: EVC attributes for the distance learning, business data example.....	54

## 1. Abstract

This document uses the service attributes and parameters that are defined in the MEF Technical Specification “Ethernet Services Attributes Phase 2” [2] and applies them to create different Ethernet services. This document defines three generic service constructs called Ethernet Service types and specifies their associated service attributes and parameters used to create Point-to-Point, Multipoint-to-Multipoint, and Rooted-Multipoint Ethernet services. This document also defines the requirements for several Ethernet services that use these generic Ethernet Service types. In addition, an informative appendix is provided showing examples of some of the defined services. This document supersedes and replaces MEF 6, Ethernet Services Definitions - Phase 1 [1].

## 2. Terminology

This section defines the terms used in this document. In many cases, the normative definitions to terms are found in other documents. In these cases, the third column is used to provide the reference that is controlling.

Term	Definition	Reference
<b>All to One Bundling</b>	A UNI attribute in which all CE-VLAN IDs are associated with a single EVC.	[2]
<b>Availability Performance</b>	A measure of the percentage of time that a service is useable.	[2]
<b>Bandwidth Profile</b>	A characterization of Service Frame arrival times and lengths at a reference point and a specification of the disposition of each Service Frame based on its level of compliance with the Bandwidth Profile. In this document the reference point is the UNI.	[2]
<b>Bandwidth profile per CoS ID</b>	A bandwidth profile applied on a per-Class of Service basis.	[2]
<b>Bandwidth profile per EVC</b>	A bandwidth profile applied on a per-EVC basis.	[2]
<b>Bandwidth profile per UNI</b>	A bandwidth profile applied on a per-UNI basis.	[2]
<b>Broadcast Service Frame</b>	A Service Frame that has the broadcast destination MAC address.	[2]
<b>Bundling</b>	A UNI attribute in which more than one CE-VLAN ID can be associated with an EVC.	[2]
<b>CBS</b>	Committed Burst Size	[2]
<b>CE</b>	Customer Edge	[2]
<b>CE-VLAN CoS</b>	Customer Edge VLAN CoS	[2]

Term	Definition	Reference
<b>CE-VLAN CoS Preservation</b>	An EVC attribute in which the CE-VLAN CoS of an egress Service Frame is identical in value to the CE-VLAN CoS of the corresponding ingress Service Frame.	[2]
<b>CE-VLAN ID</b>	Customer Edge VLAN ID	[2]
<b>CE-VLAN ID Preservation</b>	An EVC attribute in which the CE-VLAN ID of an egress Service Frame is identical in value to the CE-VLAN ID of the corresponding ingress Service Frame.	[2]
<b>CE-VLAN ID / EVC Map</b>	An association of CE-VLAN IDs with EVCs at a UNI.	[2]
<b>CE-VLAN Tag</b>	Customer Edge VLAN Tag	[2]
<b>CF</b>	Coupling Flag	[2]
<b>CIR</b>	Committed Information Rate	[2]
<b>Class of Service</b>	A set of Service Frames that have a commitment from the Service Provider to receive a particular level of performance.	[2]
<b>Class of Service Identifier</b>	An indicator for a particular CoS instance. Information derivable from a) the EVC to which the Service Frame is mapped, b) the combination of the EVC to which the Service Frame is mapped and a set of one or more than one CE-VLAN CoS values, c) the combination of the EVC to which the Service Frame is mapped and a set of one or more than one DSCP values, or d) the combination of the EVC to which the Service Frame is mapped and a set of one or more than one tunneled Layer 2 Control Protocols.	[2]
<b>CM</b>	Color Mode	[2]
<b>Color Mode</b>	CM is a Bandwidth Profile parameter. The Color Mode parameter indicates whether the color-aware or color-blind property is employed by the Bandwidth Profile. It takes a value of “color-blind” or “color-aware” only.	[2]
<b>Color-aware</b>	A Bandwidth Profile property where a pre-determined level of Bandwidth Profile compliance for each Service Frame is taken into account when determining the level of compliance for each Service Frame.	[2]
<b>Color-blind</b>	A Bandwidth Profile property where a pre-determined level of Bandwidth Profile compliance for each Service Frame, if present, is ignored when determining the level of compliance for each Service Frame.	[2]
<b>Committed Burst Size</b>	CBS is a Bandwidth Profile parameter. It limits the maximum number of bytes available for a burst of Service Frames sent at the UNI speed to remain CIR-conformant.	[2]

Term	Definition	Reference
<b>Committed Information Rate</b>	CIR is a Bandwidth Profile parameter. It defines the average rate in bits/s of Service Frames up to which the network delivers Service Frames and is committed to meeting the performance objectives defined by the CoS Service Attribute.	[2]
<b>CoS</b>	Class of Service	[2]
<b>Coupling Flag</b>	CF is a Bandwidth Profile parameter. The Coupling Flag allows the choice between two modes of operation of the rate enforcement algorithm. It takes a value of 0 or 1 only.	[2]
<b>Customer Edge</b>	Equipment on the Subscriber side of the UNI.	[2]
<b>Customer Edge VLAN CoS</b>	The Priority Code Point bits in the IEEE 802.1Q Customer VLAN Tag in a Service Frame that is either tagged or priority tagged.	[2]
<b>Customer Edge VLAN ID</b>	The identifier derivable from the content of a Service Frame that allows the Service Frame to be associated with an EVC at the UNI.	[2]
<b>Customer Edge VLAN Tag</b>	The IEEE 802.1Q Customer VLAN Tag in a tagged Service Frame.	[2]
<b>EBS</b>	Excess Burst Size	[2]
<b>Egress Bandwidth Profile</b>	A service attribute that specifies the length and arrival time characteristics of egress Service Frames at the egress UNI.	[2]
<b>Egress Service Frame</b>	A Service Frame sent from the Service Provider network to the CE.	[2]
<b>EIR</b>	Excess Information Rate	[2]
<b>E-LAN Service</b>	An Ethernet service type that is based on a Multipoint-to-Multipoint EVC.	This Document
<b>E-Line Service</b>	An Ethernet service type that is based on a Point-to-Point EVC.	This Document
<b>EPL</b>	Ethernet Private Line	This Document
<b>E-Tree Service</b>	An Ethernet service type that is based on a Rooted-Multipoint EVC.	This Document
<b>Ethernet Virtual Connection</b>	An association of two or more UNIs that limits the exchange of Service Frames to UNIs in the Ethernet Virtual Connection.	[2]
<b>EVC</b>	Ethernet Virtual Connection	[2]
<b>EVC MTU Size</b>	The maximum sized Service Frame allowed for an EVC.	[2]
<b>EVPL</b>	Ethernet Virtual Private Line	This Document



Term	Definition	Reference
<b>Excess Burst Size</b>	EBS is a Bandwidth Profile parameter. It limits the maximum number of bytes available for a burst of Service Frames sent at the UNI speed to remain EIR-conformant.	[2]
<b>Excess Information Rate</b>	EIR is a Bandwidth Profile parameter. It defines the average rate in bits/s of Service Frames up to which the network may deliver Service Frames but without any performance objectives.	[2]
<b>FDX</b>	Full Duplex	[5]
<b>FD</b>	Frame Delay	[2]
<b>FDV</b>	Frame Delay Variation	[2]
<b>FLR</b>	Frame Loss Ratio	[2]
<b>Frame</b>	Short for Ethernet Frame	[2]
<b>Frame Delay</b>	The time required to transmit a Service Frame from ingress UNI to egress UNI.	[2]
<b>Frame Delay Performance</b>	A measure of the delays experienced by different Service Frames belonging to the same CoS instance.	[2]
<b>Frame Delay Variation</b>	The difference in delay of two Service Frames.	[2]
<b>Frame Delay Variation Performance</b>	A measure of the variation in the delays experienced by different Service Frames belonging to the same CoS instance.	[2]
<b>Frame Loss Ratio Performance</b>	Frame Loss Ratio is a measure of the number of lost frames between the ingress UNI and the egress UNI. Frame Loss Ratio is expressed as a percentage.	[2]
<b>Ingress Bandwidth Profile</b>	A characterization of ingress Service Frame arrival times and lengths at the ingress UNI and a specification of disposition of each Service Frame based on its level of compliance with the characterization.	[2]
<b>Ingress Service Frame</b>	A Service Frame sent from the CE into the Service Provider network.	[2]
<b>Layer 2 Control Protocol Service Frame</b>	A Service Frame that is used for Layer 2 control, e.g., Spanning Tree Protocol.	[2]
<b>Layer 2 Control Protocol Tunneling</b>	The process by which a Layer 2 Control Protocol Service Frame is passed through the Service Provider network without being processed and is delivered unchanged to the proper UNI(s).	[2]
<b>Maximum Number of EVCs</b>	The maximum number of EVCs that may be on a UNI.	[2]

Term	Definition	Reference
<b>Maximum number of UNIs</b>	The maximum number of UNIs that may be in an EVC.	[2]
<b>MEN</b>	Metro Ethernet Network	[12]
<b>Metro Ethernet Network</b>	The Service Provider’s network providing Ethernet services.	[12]
<b>MNU</b>	Maximum Number of UNIs	[2]
<b>MTU</b>	Maximum Transmission Unit	This Document
<b>MTU size</b>	The maximum sized Service Frame allowed for an Ethernet service.	[2]
<b>Multicast Service Frame</b>	A Service Frame that has a multicast destination MAC address.	[2]
<b>Multipoint-to-Multipoint EVC</b>	An EVC with two or more UNIs. A Multipoint-to-Multipoint EVC with two UNIs is different from a Point-to-Point EVC because one or more additional UNIs can be added to it.	[2]
<b>N/A</b>	Not Applicable	
<b>N/S</b>	Not Specified	
<b>Point-to-Point EVC</b>	An EVC with exactly 2 UNIs.	[2]
<b>Rooted-Multipoint EVC</b>	A multipoint EVC in which each UNI is designated as either a Root or a Leaf. Ingress Service Frames at a Root UNI can be delivered to one or more of any of the other UNIs in the EVC. Ingress Service Frames at a Leaf UNI can only be delivered to one or more Root UNIs in the EVC.	[2]
<b>Service Frame</b>	An Ethernet frame transmitted across the UNI toward the Service Provider or an Ethernet frame transmitted across the UNI toward the Subscriber.	[2]
<b>Service Frame Delivery</b>	An EVC service attribute defined in [2]	[2]
<b>Service Level Agreement</b>	The contract between the Subscriber and Service Provider specifying the agreed to service level commitments and related business agreements.	[2]
<b>Service Level Specification</b>	The technical specification of the service level being offered by the Service Provider to the Subscriber.	[2]
<b>Service Multiplexing</b>	A UNI service attribute in which the UNI can be in more than one EVC instance.	[2]
<b>Service Provider</b>	The organization providing Ethernet Service(s).	[2]
<b>SLA</b>	Service Level Agreement	[2]
<b>SLS</b>	Service Level Specification	[2]

Term	Definition	Reference
<b>Subscriber</b>	The organization purchasing and/or using Ethernet Services.	[2]
<b>UNI</b>	User Network Interface	[2]
<b>UNI MTU Size</b>	The maximum sized Service Frame allowed at the UNI.	[2]
<b>Unicast Service Frame</b>	A Service Frame that has a unicast destination MAC address.	[2]
<b>User Network Interface</b>	The physical demarcation point between the responsibility of the Service Provider and the responsibility of the Subscriber.	[2]
<b>VLAN</b>	Virtual LAN	[4]

**Table 1: Terminology and Definitions Table**

### 3. Scope

This document defines Phase 2 Ethernet services. It supersedes and replaces MEF 6 [1], “Ethernet Services Definitions – Phase 1”. This document defines a third service type: E-Tree, based on a Rooted-Multipoint Ethernet Virtual Connection (EVC). It also updates service attributes and requirements for the existing defined service types – E-Line (based on a Point-to-Point EVC) and E-LAN (based on a Multipoint-to-Multipoint EVC). These updated service attributes are those defined in “Ethernet Services Attributes - Phase 2” [2].

This document defines generic service constructs called Ethernet Service types used to create Ethernet services over a Metro Ethernet Network (MEN). It specifies the Ethernet service attributes and parameters that are used with the different Ethernet Service types, but does not define how the service attributes may be implemented.

This document also defines the service attribute requirements for several Ethernet Services that use the generic Ethernet Service type constructs. Where possible, recommendations for the service attributes and associated parameters are made for these particular Ethernet Services. All services in this document provide for connectivity among User Network Interfaces (UNIs).

This document does not define application-based services that may be offered using these Ethernet Service types, e.g., IP Telephony service, nor does it define non-Ethernet-based services that may be offered over the MEN, e.g., Circuit Emulation Services over a TDM (e.g., T1) UNI. This document does not define how the services may be supported in the MEN using different transport and switching technologies.

#### 3.1 SCOPE OF FUTURE PHASES

Subsequent phases of this specification may add additional services or augment existing services with newly defined service attributes or parameters defined in other MEF Technical Committee specifications.

## 4. Compliance Levels

The key words “**MUST**”, “**MUST NOT**”, “**REQUIRED**”, “**SHALL**”, “**SHALL NOT**”, “**SHOULD**”, “**SHOULD NOT**”, “**RECOMMENDED**”, “**MAY**”, and “**OPTIONAL**” in this document are to be interpreted as described in RFC 2119 [6]. All key words use upper case, bold text.

## 5. Introduction

Ethernet has its origins in providing network connectivity and was not originally used to provide wide area services. With the introduction of Metro Ethernet services, Service Providers started using this Ethernet “connectivity” technology to provide Ethernet “services”. While the IEEE 802.3 Ethernet protocol is still used, service-related attributes and parameters need to be added in order to create an Ethernet service.

This document uses the service attributes and parameters that are defined in the MEF Technical Specification “Ethernet Services Attributes Phase 2” [2] and applies them to create different Ethernet services. This document defines three generic service constructs called Ethernet Service types and specifies their associated service attributes and parameters used to create Point-to-Point, Multipoint-to-Multipoint, and Rooted-Multipoint Ethernet services. This document also defines the requirements for several Ethernet services that use these generic Ethernet Service types.

The Phase 2 Ethernet services described in this document are from a Subscriber perspective and are defined based on the service attributes that might appear in a Service Level Agreement (SLA) or Service Level Specification (SLS). The services are instantiated at an UNI with IEEE compliant Ethernet interfaces interconnecting the customer equipment to the Service Provider network. These services, however, are agnostic of the underlying network infrastructure within the Metro Ethernet Network (MEN) and may be supported over a combination of network technologies in the Service Provider’s network that could include: MPLS, RPR, SONET, VLAN switching, WDM, etc.

## 6. Ethernet Service Definition Framework (Normative)

The Ethernet Service Definition Framework provides a model for specifying Ethernet services. Ethernet Service types are generic constructs used to create a broad range of services. Each Ethernet Service type has a set of Ethernet service attributes that define the service characteristics. These Ethernet Service Attributes in turn have a set of parameters associated with them that provide various options for the different service attributes. Refer to Figure 1.

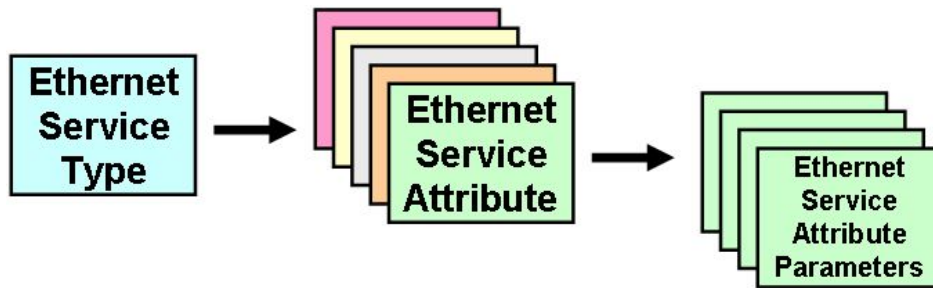

**Figure 1: Ethernet Service Definition Framework**

This document defines three Ethernet Service type generic constructs, namely, Ethernet Line (E-Line) Service type (refer to Section 6.1), Ethernet LAN (E-LAN) Service type (refer to Section 6.2) and Ethernet Tree (E-Tree) Service type (refer to Section 6.3), and their associated service attributes and parameters. The key differentiator is the type of connectivity provided, as indicated by the ‘EVC Type’ service attribute. The UNI and EVC service attributes and parameters are normatively defined in [2].

More than one Ethernet Service is defined for each of the three Ethernet Service types. These are differentiated by the method for service identification used at the UNIs. Services using All to One Bundling UNIs (port-based) are referred to as ‘Private’, while services using UNIs that are that are Service Multiplexed (VLAN-based), are referred to as ‘Virtual Private’. This relationship is shown in Table 2 below.

Service Type	Port-Based (All to One Bundling)	VLAN-Based (EVC identified by VLAN ID)
<b>E-Line</b> (point-to-point EVC)	Ethernet Private Line (EPL)	Ethernet Virtual Private Line (EVPL) <sup>1</sup>
<b>E-LAN</b> (multipoint-to-multipoint EVC)	Ethernet Private LAN (EP-LAN)	Ethernet Virtual Private LAN (EVP-LAN)
<b>E-Tree</b> (rooted multipoint EVC)	Ethernet Private Tree (EP-Tree)	Ethernet Virtual Private Tree (EVP-Tree)

**Table 2: Ethernet Services**

Please note that although some of the service names used in Table 2 and throughout this document are the same as names used in ITU-T G.8011.1 [13] and G.8011.2 [14], namely EPL and EVPL, the definitions of those services are different due to the fact that the ITU recommendations take a network view instead of the services view used in this document.

Table 3 below specifies the UNI service attributes, parameters, and values that are common for all Ethernet service types. The first column of this table identifies the UNI service attributes, as defined in [2]. The entries in the second column specify the UNI requirements, regardless of the

<sup>1</sup> EVPL as specified in this document is different from EVPL as was specified in [1]. In this document, EVPL cannot have All to One Bundling at the UNIs while in [1] All to One Bundling was allowed at the UNIs in EVPL.

number of EVCs present on the UNI. These requirements allow for options for certain UNI attributes, e.g., physical medium, speed, maximum number of EVCs, application of ingress and egress bandwidth profiles, and layer 2 control protocol processing. Please note that such options may be different at each UNI in the EVC.

UNI Service Attribute	Requirement
UNI Identifier	Arbitrary text string to identify the UNI.
Physical Medium	UNI Type 2 Physical Interface [5] except for PON interfaces <sup>2</sup>
Speed	10 Mbps, 100 Mbps, 10/100 Mbps Auto-negotiation, 10/100/1000 Mbps Auto-negotiation, 1 Gbps, or 10 Gbps.
Mode	Full Duplex
MAC Layer	IEEE 802.3-2005 [5]
UNI MTU Size	<b>MUST</b> be $\geq 1522$ .
Service Multiplexing	Yes or No. <b>MUST</b> be No if All to One Bundling is Yes.
Bundling	Yes or No. <b>MUST</b> be No if All to One Bundling is Yes.
All to One Bundling	Yes or No. <b>MUST</b> be No if Bundling or Service Multiplexing is Yes.
CE-VLAN ID for untagged and priority tagged Service Frames	<b>MUST</b> specify CE-VLAN ID for untagged and priority tagged Service Frames in the range of 1-4094. This requirement does not apply for services with all to one bundling at the UNI.
Maximum number of EVCs	<b>MUST</b> be an integer $\geq 1$ .
Ingress Bandwidth Profile Per UNI	<b>OPTIONAL</b> . If supported, <b>MUST</b> specify <CIR, CBS, EIR, EBS, CM, CF>. <b>MUST NOT</b> be combined with any other type of ingress bandwidth profile.
Egress Bandwidth Profile Per UNI	<b>OPTIONAL</b> . If supported, <b>MUST</b> specify <CIR, CBS, EIR, EBS, CM, CF>. <b>MUST NOT</b> be combined with any other type of egress bandwidth profile.
Layer 2 Control Protocols Processing	For each protocol, <b>MUST</b> specify one of: Peer, Discard, Pass to EVC, or Peer and Pass to EVC.

**Table 3: UNI service attributes and parameter values for all service types**

The following subsections define each of the three service types. Section 7 normatively defines the Ethernet services.

### 6.1 ETHERNET LINE (E-LINE) PHASE 2 SERVICE TYPE

Any Ethernet service that is based on a Point-to-Point Ethernet Virtual Connection (EVC) **SHALL** be designated as an Ethernet Line (E-Line) Service type. The E-Line Service is illustrated in Figure 2. An E-Line Service type can be used to create a broad range of Point-to-Point services.

<sup>2</sup> MEF does not support Ethernet services over PON interfaces.

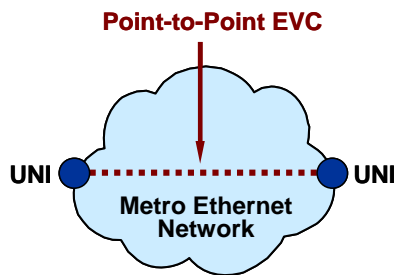

**Figure 2: E-Line Service type using Point-to-Point EVC**

In its simplest form, an E-Line Service type can provide symmetrical bandwidth for data sent in either direction with no performance assurances, e.g., best effort service between two 10Mbps UNIs. In more sophisticated forms, an E-Line Service type may be between two UNIs with different line rates and may be defined with performance assurances such as CIR with an associated CBS, EIR with an associated EBS, delay, delay variation, loss, and availability for a given Class of Service (CoS) instance. Service Multiplexing may occur at one or both UNIs in the EVC. For example, more than one Point-to-Point EVC may be offered on the same physical port at one or both of the UNIs.

The E-Line Service type UNI service attributes, parameters, and values can be found in Table 3.

The E-Line Service type EVC per UNI service attributes, parameters, and values can be found in Table 4 below. The first column of this table comes from [2]. The entries in the second column define the E-Line Service type.

EVC per UNI Service Attribute	E-Line Service type Requirement
UNI EVC ID	A string formed by the concatenation of the UNI ID and the EVC ID.
CE-VLAN ID / EVC Map	<b>MUST</b> specify the mapping table of CE-VLAN IDs to the EVC at the UNI.
Ingress Bandwidth Profile Per EVC	<b>OPTIONAL</b> . If supported, <b>MUST</b> specify <CIR, CBS, EIR, EBS, CM, CF>. <b>MUST NOT</b> be combined with any other type of ingress bandwidth profile.
Ingress Bandwidth Profile Per CoS Identifier	<b>OPTIONAL</b> . If supported, <b>MUST</b> specify CoS ID per [2], section 6.8, and <b>MUST</b> specify <CIR, CBS, EIR, EBS, CM, CF> for each CoS. <b>MUST NOT</b> be combined with any other type of ingress bandwidth profile.
Egress Bandwidth Profile Per EVC	<b>MUST NOT</b> specify <sup>3</sup> .

<sup>3</sup> For E-Line services, it is expected that an Ingress Bandwidth Profile will be applied at the ingress UNI such that traffic on the EVC is already controlled; therefore, there is no need to apply an Egress Bandwidth Profile per EVC or CoS at the egress UNI.

EVC per UNI Service Attribute	E-Line Service type Requirement
Egress Bandwidth Profile Per CoS Identifier	<b>MUST NOT</b> specify.

**Table 4: E-Line Service type EVC per UNI service attributes and parameter values**

The E-Line Service type EVC service attributes, parameters, and values can be found in Table 5 below. The first column of this table comes from [2]. The entries in the second column define the E-Line Service type.

EVC Service Attribute	E-Line Service type Requirement
EVC Type	<b>MUST</b> be Point-to-Point.
EVC ID	An arbitrary string, unique across the MEN, for the EVC supporting the service instance.
UNI List	<b>MUST</b> provide the list of UNI Identifiers and type for each UNI associated with the EVC. UNI Type must be Root for each UNI.
Maximum Number of UNIs	<b>MUST</b> be 2.
EVC MTU size	<b>MUST</b> be $\leq$ minimum of UNI MTU sizes.
CE-VLAN ID Preservation	<b>MUST</b> be either Yes or No
CE-VLAN CoS Preservation	<b>MUST</b> be either Yes or No
Unicast Service Frame Delivery	Deliver Unconditionally or Deliver Conditionally. If Delivered Conditionally, <b>MUST</b> specify the delivery criteria.
Multicast Service Frame Delivery	Deliver Unconditionally or Deliver Conditionally. If Delivered Conditionally, <b>MUST</b> specify the delivery criteria.
Broadcast Service Frame Delivery	Deliver Unconditionally or Deliver Conditionally. If Delivered Conditionally, <b>MUST</b> specify the delivery criteria.
Layer 2 Control Protocol Processing (only applies for L2CPs passed to the EVC)	For each protocol passed to the EVC, <b>MUST</b> specify one of: Tunnel or Discard.
EVC Performance	At least one CoS is <b>REQUIRED</b> . <b>MUST</b> specify CoS ID, per section 6.8 of [2]. <b>MUST</b> list values for each of the following attributes {Frame Delay, Frame Delay Variation, Frame Loss Ratio, and Availability} for each CoS, where Not Specified (N/S) is an acceptable value.

**Table 5: E-Line Service type EVC service attributes and parameter values**

## 6.2 ETHERNET LAN (E-LAN) SERVICE TYPE



Any Ethernet Service that is based upon a Multipoint-to-Multipoint EVC **SHALL** be designated as an Ethernet LAN (E-LAN) Service type. The E-LAN service type is illustrated in Figure 3 below.

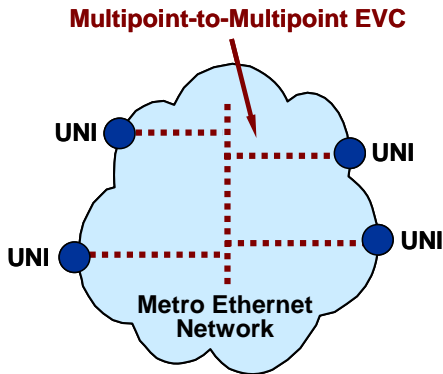

**Figure 3: E-LAN Service type using Multipoint-to-Multipoint EVC**

An E-LAN Service type can be used to create a broad range of services. In its simplest form, an E-LAN Service type can provide a best effort service with no performance assurances between the UNIs. In more sophisticated forms, an E-LAN Service type may be defined with performance assurances such as CIR with an associated CBS, EIR with an associated EBS, delay, delay variation, loss, and availability for a given CoS instance.

For an E-LAN service type, service multiplexing may occur at none, one, or more than one of the UNIs in the EVC. For example, an E-LAN Service type (Multipoint-to-Multipoint EVC) and an E-Line service type (Point-to-Point EVC) may be service multiplexed at the same UNI. In this example, the E-LAN service type may be used to interconnect other Subscriber sites while the E-Line service type is used to connect to the Internet with both services offered via service multiplexing at the same UNI.

The E-LAN service type UNI Service Attributes and requirements can be found in Table 3.

The E-LAN service type EVC per UNI Service Attributes and requirements can be found in Table 6 below. The first column of this table comes from [2]. The entries in the second column define the E-LAN Service type.

EVC per UNI Service Attribute	E-LAN Service type Requirement
UNI EVC ID	A string formed by the concatenation of the UNI ID and the EVC ID.
CE-VLAN ID / EVC Map	<b>MUST</b> specify the mapping table of CE-VLAN IDs to the EVC at the UNI.
Ingress Bandwidth Profile Per EVC	<b>OPTIONAL.</b> If supported, <b>MUST</b> specify <CIR, CBS, EIR, EBS, CM, CF> [2]. <b>MUST NOT</b> be combined with any other type of ingress bandwidth profile.

EVC per UNI Service Attribute	E-LAN Service type Requirement
Ingress Bandwidth Profile Per CoS Identifier	<b>OPTIONAL.</b> If supported, <b>MUST</b> specify CoS ID per [2], section 6.8, and <b>MUST</b> specify <CIR, CBS, EIR, EBS, CM, CF> for each CoS. <b>MUST NOT</b> be combined with any other type of ingress bandwidth profile.
Egress Bandwidth Profile Per EVC	<b>OPTIONAL.</b> If supported, <b>MUST</b> specify <CIR, CBS, EIR, EBS, CM, CF> [2]. <b>MUST NOT</b> be combined with any other type of egress bandwidth profile.
Egress Bandwidth Profile Per CoS Identifier	<b>OPTIONAL.</b> If supported, <b>MUST</b> specify CoS ID per [2], section 6.8, and <b>MUST</b> specify <CIR, CBS, EIR, EBS, CM, CF> for each CoS. <b>MUST NOT</b> be combined with any other type of egress bandwidth profile.

**Table 6 : E-LAN Service type EVC per UNI service attributes and parameter values**

The E-LAN service type EVC service attributes, parameters, and values can be found in Table 7 below. The first column of this table comes from [2]. The entries in the second column define the E-LAN Service type.

EVC Service Attribute	E-LAN Service type Requirement
EVC Type	<b>MUST</b> be Multipoint-to-Multipoint.
EVC ID	An arbitrary string, unique across the MEN, for the EVC supporting the service instance.
UNI List	<b>MUST</b> provide the list of UNI Identifiers and type for each UNI associated with the EVC. UNI Type must be Root for each UNI
Maximum Number of UNIs	<b>MUST</b> be $\geq 2$ .
EVC MTU size	<b>MUST</b> be $\leq$ minimum of UNI MTU sizes.
CE-VLAN ID Preservation	<b>MUST</b> be either Yes or No
CE-VLAN CoS Preservation	<b>MUST</b> be either Yes or No
Unicast Service Frame Delivery	Deliver Unconditionally or Deliver Conditionally. If Delivered Conditionally, <b>MUST</b> specify the delivery criteria.
Multicast Service Frame Delivery	Deliver Unconditionally or Deliver Conditionally. If Delivered Conditionally, <b>MUST</b> specify the delivery criteria.
Broadcast Service Frame Delivery	Deliver Unconditionally or Deliver Conditionally. If Delivered Conditionally, <b>MUST</b> specify the delivery criteria.

EVC Service Attribute	E-LAN Service type Requirement
Layer 2 Control Protocol Processing (only applies for L2CPs passed to the EVC)	For each protocol passed to the EVC, <b>MUST</b> specify one of: Tunnel or Discard.
EVC Performance	At least one CoS is <b>REQUIRED</b> . <b>MUST</b> specify CoS ID, per section 6.8 of [2]. <b>MUST</b> list values for each of the following attributes {Frame Delay, Frame Delay Variation, Frame Loss Ratio, and Availability} for each CoS, where Not Specified (N/S) is an acceptable value.

**Table 7: E-LAN Service type EVC service attributes and parameter values**

**6.3 ETHERNET TREE (E-TREE) SERVICE TYPE**

Any Ethernet Service that is based upon a Rooted-Multipoint Ethernet Virtual Connection, as defined in MEF 10.1, **SHALL** be designated as an Ethernet Tree (E-Tree) Service type. The E-Tree service type with a single Root is illustrated in Figure 4.

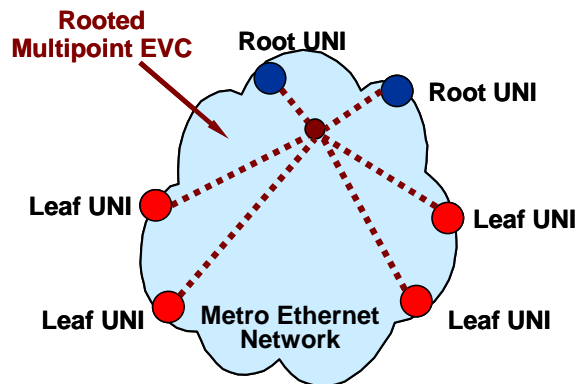

**Figure 4: E-Tree Service type using Rooted-Multipoint EVC**

In its simplest form, an E-Tree Service type can provide a single Root for multiple Leaf UNIs. Each Leaf UNI can exchange data with only the Root UNI. A service frame sent from one Leaf UNI with a destination address for another Leaf UNI is not delivered. This service could be useful for Internet Access or Video over IP applications, such as multicast/broadcast packet video. One or more than one CoS may be associated with this service.

In more sophisticated forms, an E-Tree Service type may support two or more Root UNIs. In this scenario, each Leaf UNI can exchange data only with the Root UNIs. As well, the Roots can communicate with each other. In such a service, redundant access to ‘the Root’ can also be provided, effectively allowing for enhanced service reliability and flexibility. This service is depicted in Figure 5 below.

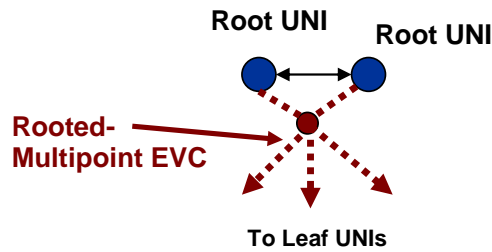

**Figure 5: E-Tree Service type using Multiple Roots**

For an E-Tree service type, service multiplexing may occur at none, one, or more than one of the UNIs in the EVC. For example, an E-Tree service type, using a Rooted-Multipoint EVC, and an E-Line service type, using a Point-to-Point EVC, may be service multiplexed at the same UNI. In this example, the E-Tree service type may be used to support a specific application at the Subscriber UNI, e.g., ISP access to redundant PoPs (multiple Roots at ISP PoPs), while the E-Line Service type is used to connect to another enterprise site with a Point-to-Point EVC.

The E-Tree service type UNI Service Attributes and requirements can be found in Table 3.

The E-Tree service type EVC per UNI service attributes and requirements can be found in Table 8 below. The first column of this table comes from [2]. The entries in the second column define the E-Tree Service type.

EVC per UNI Service Attribute	E-Tree EVC per UNI Service type Requirement
UNI EVC ID	A string formed by the concatenation of the UNI ID and the EVC ID.
CE-VLAN ID / EVC Map	<b>MUST</b> specify the mapping table of CE-VLAN IDs to the EVC at the UNI.
Ingress Bandwidth Profile Per EVC	<b>OPTIONAL</b> . If supported, <b>MUST</b> specify <CIR, CBS, EIR, EBS, CM, CF> [2]. <b>MUST NOT</b> be allowed if any other ingress bandwidth profile is applied at this UNI for this EVC.
Ingress Bandwidth Profile Per CoS Identifier	<b>OPTIONAL</b> . If supported, <b>MUST</b> specify CoS ID per [2], section 6.8, and <b>MUST</b> specify <CIR, CBS, EIR, EBS, CM, CF> for each CoS. <b>MUST NOT</b> be combined with any other type of ingress bandwidth profile.
Egress Bandwidth Profile Per EVC	<b>OPTIONAL</b> . If supported, <b>MUST</b> specify <CIR, CBS, EIR, EBS, CM, CF> [2]. <b>MUST NOT</b> be combined with any other type of egress bandwidth profile.
Egress Bandwidth Profile Per CoS Identifier	<b>OPTIONAL</b> . If supported, <b>MUST</b> specify CoS ID per [2], section 6.8, and <b>MUST</b> specify <CIR, CBS, EIR, EBS, CM, CF> for each CoS. <b>MUST NOT</b> be combined with any other type of egress bandwidth profile.

**Table 8 : E-Tree Service type EVC per UNI service attributes and parameter values**

The E-Tree service type EVC service attributes, parameters, and values can be found in Table 9 below. The first column of this table comes from [2]. The entries in the second column define the E-Tree Service type.

<b>EVC Service Attribute</b>	<b>E-Tree EVC Service type Requirement</b>
EVC Type	<b>MUST</b> be Rooted-Multipoint
EVC ID	An arbitrary string, unique across the MEN, for the EVC supporting the service instance.
UNI List	<b>MUST</b> provide the list of UNI Identifiers and type for each UNI associated with the EVC. The number of Root UNIs in the list <b>MUST</b> be $\geq 1$ . The number of Leaf UNIs in the list <b>MUST</b> be $\geq 0^4$ .
Maximum Number of UNIs	<b>MUST</b> be $\geq 2$
EVC MTU size	<b>MUST</b> be $\leq$ minimum of UNI MTU sizes.
CE-VLAN ID Preservation	<b>MUST</b> be either Yes or No
CE-VLAN CoS Preservation	<b>MUST</b> be either Yes or No
Unicast Service Frame Delivery	Deliver Unconditionally or Deliver Conditionally. If Delivered Conditionally, <b>MUST</b> specify the delivery criteria.
Multicast Service Frame Delivery	Deliver Unconditionally or Deliver Conditionally. If Delivered Conditionally, <b>MUST</b> specify the delivery criteria.
Broadcast Service Frame Delivery	Deliver Unconditionally or Deliver Conditionally. If Delivered Conditionally, <b>MUST</b> specify the delivery criteria.
Layer 2 Control Protocol Processing (only applies for L2CPs passed to the EVC)	For each protocol passed to the EVC, <b>MUST</b> specify one of: Tunnel or Discard
EVC Performance	At least one CoS is <b>REQUIRED</b> . <b>MUST</b> specify CoS ID, per section 6.8 of [2]. <b>MUST</b> list values for each of the following attributes {Frame Delay, Frame Delay Variation, Frame Loss Ratio, and Availability} for each CoS, where Not Specified (N/S) is an acceptable value.

**Table 9: E-Tree Service type EVC service attributes and parameter values**

## 7. Service Definitions (Normative)

An Ethernet service is defined by specifying service attribute parameter values for a given Ethernet Service type. This section defines the required service attributes and related parameter values for the Ethernet services specified in this Technical Specification. If any of the Ethernet

<sup>4</sup> An E-Tree service may have no leaves, for example, during times when leaf UNIs are being added or removed.

services in this section are offered, the normative text for each service attribute is applied. Note that other variations of these Ethernet services are also possible.

**7.1 ETHERNET PRIVATE LINE SERVICE**

An Ethernet Private Line (EPL) service is specified using an E-Line Service type. An EPL service uses a Point-to-Point EVC between two UNIs and provides a high degree of transparency for Service Frames between the UNIs it interconnects such that the Service Frame’s header and payload are identical at both the source and destination UNI when a Service Frame is delivered. Figure 6 below shows the basic structure of EPL service.

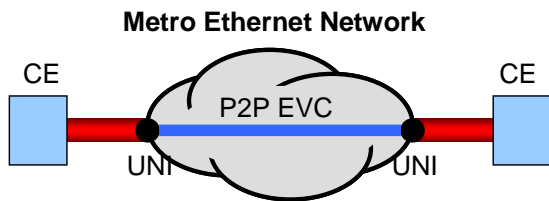

**Figure 6: Ethernet Private Line (EPL) Service**

EPL service does not allow for Service Multiplexing, i.e., a dedicated UNI (physical interface) is used for the service. Because of the high degree of transparency of this service, there is no need for coordination between the Subscriber and Service Provider on a detailed CE-VLAN ID/EVC Map for each UNI because all Service Frames are mapped to a single EVC at the UNI. Refer to [2] for more information on CE-VLAN ID/EVC Map attribute.

For cases where EVC speed is less than the UNI speed, the CE is expected to shape traffic to the Ingress Bandwidth Profile of the service such that all of its traffic, including certain L2CPs that require delivery for proper operation, is not discarded by the service.

Table 10 provides the UNI service attributes, parameters, and values for the Ethernet Private Line.

UNI Service Attribute	Service Attribute Parameters and Values
UNI Identifier	Arbitrary text string to identify the UNI.
Physical Medium	UNI Type 2 Physical Interface [5] except for PON interfaces
Speed	10 Mbps, 100 Mbps, 10/100 Mbps Auto-negotiation, 10/100/1000 Mbps Auto-negotiation, 1 Gbps, or 10 Gbps
Mode	<b>MUST</b> be Full Duplex
MAC Layer	IEEE 802.3-2005 [5]
UNI MTU Size	<b>MUST</b> be $\geq 1522$
Service Multiplexing	<b>MUST</b> be No
Bundling	<b>MUST</b> be No
All to One Bundling	<b>MUST</b> be Yes

UNI Service Attribute	Service Attribute Parameters and Values
CE-VLAN ID for untagged and priority tagged Service Frames	All untagged and priority tagged Service Frames at the UNI <b>MUST</b> map to the same EVC as is used for all other Service Frames.
Maximum number of EVCs	<b>MUST</b> be 1
Ingress Bandwidth Profile Per UNI	<b>MUST NOT</b> specify <sup>5</sup>
Egress Bandwidth Profile Per UNI	<b>MUST NOT</b> specify
Layer 2 Control Protocol Processing	<b>MUST</b> specify in accordance with Section 8.1 of this document.

**Table 10: UNI service attributes and parameters for the EPL service**

Table 11 provides the EVC per UNI service attributes, parameters, and values for the Ethernet Private Line (EPL) service.

EVC per UNI Service Attribute	Service Attribute Parameters and Values
UNI EVC ID	A string formed by the concatenation of the UNI ID and the EVC ID.
CE-VLAN ID / EVC Map	All Service Frames at the UNI <b>MUST</b> map to a single Point-to-Point EVC.
Ingress Bandwidth Profile Per EVC	<b>OPTIONAL.</b> If supported, <b>MUST</b> specify <CIR, CBS, EIR, EBS, CM, CF>. <b>MUST NOT</b> be combined with any other type of ingress bandwidth profile.
Ingress Bandwidth Profile Per CoS ID	<b>OPTIONAL.</b> If supported, <b>MUST</b> specify CoS ID per [2], section 6.8, and <b>MUST</b> specify <CIR, CBS, EIR, EBS, CM, CF> for each CoS. <b>MUST NOT</b> be combined with any other type of ingress bandwidth profile
Egress Bandwidth Profile Per EVC	<b>MUST NOT</b> specify
Egress Bandwidth Profile Per CoS ID	<b>MUST NOT</b> specify

**Table 11: EVC per UNI service attributes and parameters for the EPL service**

Table 12 provides the EVC service attributes, parameters, and values for the Ethernet Private Line (EPL) service.

EVC Service Attribute	Service Attribute Parameters and Values
EVC Type	<b>MUST</b> be Point-to-Point
EVC ID	An arbitrary string, unique across the MEN, for the EVC supporting the service instance.

<sup>5</sup> See Ingress Bandwidth Profile per EVC service attribute in Table 11.

EVC Service Attribute	Service Attribute Parameters and Values
UNI List	<b>MUST</b> list the two UNIs associated with the EVC. The UNI type <b>MUST</b> be Root for each UNI.
Maximum Number of UNIs	<b>MUST</b> be 2
EVC MTU size	<b>MUST</b> be $\geq 1522$
CE-VLAN ID Preservation	<b>MUST</b> be Yes
CE-VLAN CoS Preservation	<b>MUST</b> be Yes
Unicast Service Frame Delivery	<b>MUST</b> Deliver Unconditionally
Multicast Service Frame Delivery	<b>MUST</b> Deliver Unconditionally
Broadcast Service Frame Delivery	<b>MUST</b> Deliver Unconditionally
Layer 2 Control Protocols Processing (only applies for L2CPs passed to the EVC)	<b>MUST</b> specify in accordance with Section 8.1 of this document.
EVC Performance	At least one CoS is <b>REQUIRED</b> . <b>MUST</b> specify CoS ID, per section 6.8 of [2]. <b>MUST</b> list values for each of the following attributes {Frame Delay, Frame Delay Variation, Frame Loss Ratio, and Availability} for each CoS, where Not Specified (N/S) is an acceptable value.

**Table 12: EVC service attributes and parameters for the EPL service**

The definition of EPL in this document is somewhat different than the superseded definition of EPL that was given in MEF 6 [1]. In addition to changes to the Layer 2 Control Protocol processing requirements (see Section 8), the other key differences are captured in Table 13.

Attribute	EPL in this Document	EPL in MEF 6 [1]
Bandwidth Profile Parameter Values	$EIR \geq 0, EBS \geq 0$	$EIR = 0, EBS = 0$
Classes of Service	Multiple allowed	One allowed

**Table 13: Differences in EPL from EPL in MEF 6**

## 7.2 ETHERNET VIRTUAL PRIVATE LINE SERVICE



An Ethernet Virtual Private Line (EVPL) is created using an E-Line Service type. An EVPL can be used to create services similar to the Ethernet Private Line (EPL) with some notable exceptions. First, an EVPL allows for service multiplexing at the UNI. This capability allows more than one EVC to be supported at the UNI where the EPL does not allow this. Second, an EVPL need not provide as much transparency of Service Frames as with an EPL. Because service multiplexing is permitted, some Service Frames may be sent to one EVC while other Service Frames may be sent to other EVCs.

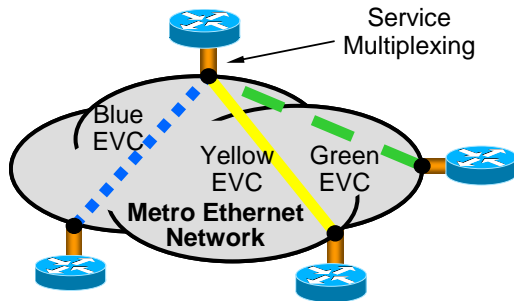

Figure 7 below shows the basic structure of EVPL service.

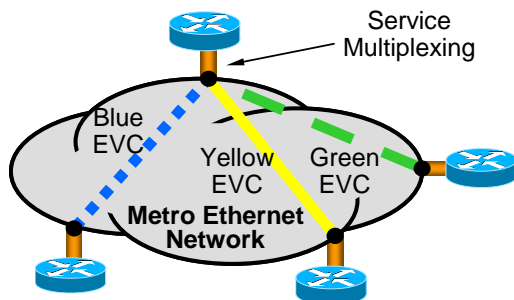

Figure 7: Ethernet Virtual Private Line (EVPL) Service

Table 14 provides the UNI service attributes, parameters, and values for the Ethernet Virtual Private Line (EVPL) using the E-Line Service type.

UNI Service Attribute	Service Attribute Parameters and Values
UNI Identifier	Arbitrary text string to identify the UNI.
Physical Medium	UNI Type 2 Physical Interface [5] except for PON interfaces
Speed	10 Mbps, 100 Mbps, 10/100 Mbps Auto-negotiation, 10/100/1000 Mbps Auto-negotiation, 1 Gbps, or 10 Gbps
Mode	<b>MUST</b> be Full Duplex
MAC Layer	IEEE 802.3-2005 [5]
UNI MTU Size	<b>MUST</b> be $\geq 1522$
Service Multiplexing	<b>SHOULD</b> be supported at one or more UNIs.
Bundling	Yes or No. If Yes, then CE-VLAN ID Preservation <b>MUST</b> be Yes.
All to One Bundling	<b>MUST</b> be No

UNI Service Attribute	Service Attribute Parameters and Values
CE-VLAN ID for untagged and priority tagged Service Frames	<b>MUST</b> specify CE-VLAN ID for untagged and priority tagged Service Frames in the range of 1-4094.
Maximum number of EVCs	<b>MUST</b> be $\geq 1$
Ingress Bandwidth Profile Per UNI	<b>OPTIONAL</b> . If supported, <b>MUST</b> specify <CIR, CBS, EIR, EBS, CM, CF>. <b>MUST NOT</b> be combined with any other type of ingress bandwidth profile.
Egress Bandwidth Profile Per UNI	<b>OPTIONAL</b> . If supported, <b>MUST</b> specify <CIR, CBS, EIR, EBS, CM, CF>. <b>MUST NOT</b> be combined with any other type of egress bandwidth profile.
Layer 2 Control Protocol Processing	<b>MUST</b> specify in accordance with Section 8.2 of this document.

**Table 14: UNI service attributes and parameters for EVPL service**

Table 15 provides the EVC per UNI service attributes, parameters, and values for the Ethernet Virtual Private Line (EVPL) using the E-Line Service type.

EVC per UNI Service Attribute	Service Attribute Parameters and Values
UNI EVC ID	A string formed by the concatenation of the UNI ID and the EVC ID.
CE-VLAN ID / EVC Map	<b>MUST</b> specify mapping table of CE-VLAN IDs to the EVC ID.
Ingress Bandwidth Profile Per EVC	<b>OPTIONAL</b> . If supported, <b>MUST</b> specify <CIR, CBS, EIR, EBS, CM, CF>. <b>MUST NOT</b> be combined with any other type of ingress bandwidth profile.
Ingress Bandwidth Profile Per CoS ID	<b>OPTIONAL</b> . If supported, <b>MUST</b> specify CoS ID per [2], section 6.8, and <b>MUST</b> specify <CIR, CBS, EIR, EBS, CM, CF> for each CoS. <b>MUST NOT</b> be combined with any other type of ingress bandwidth profile.
Egress Bandwidth Profile Per EVC	<b>MUST</b> be No
Egress Bandwidth Profile Per CoS ID	<b>MUST</b> be No

**Table 15: EVC per UNI service attributes and parameters for EVPL service**

Table 16 provides the EVC service attributes, parameters, and values for the Ethernet Virtual Private Line (EVPL) using the E-Line Service type.

EVC Service Attribute	Service Attribute Parameters and Values
EVC Type	<b>MUST</b> be Point-to-Point
EVC ID	An arbitrary string, unique across the MEN, for the EVC supporting the service instance.

EVC Service Attribute	Service Attribute Parameters and Values
UNI List	<b>MUST</b> list the two UNIs associated with the EVC. The UNI type <b>MUST</b> be Root for each UNI.
Maximum Number of UNIs	<b>MUST</b> be 2
EVC MTU size	<b>MUST</b> be $\geq 1522$
CE-VLAN ID Preservation	<b>MUST</b> be either Yes or No
CE-VLAN CoS Preservation	<b>MUST</b> be either Yes or No
Unicast Service Frame Delivery	Deliver Unconditionally or Deliver Conditionally. If Delivered Conditionally, <b>MUST</b> specify the delivery criteria.
Multicast Service Frame Delivery	Deliver Unconditionally or Deliver Conditionally. If Delivered Conditionally, <b>MUST</b> specify the delivery criteria.
Broadcast Service Frame Delivery	Deliver Unconditionally or Deliver Conditionally. If Delivered Conditionally, <b>MUST</b> specify the delivery criteria.
Layer 2 Control Protocols Processing (only applies for L2CPs passed to the EVC)	<b>MUST</b> specify in accordance with Section 8.2 of this document.
EVC Performance	At least one CoS is <b>REQUIRED</b> . <b>MUST</b> specify CoS ID, per section 6.8 of [2]. <b>MUST</b> list values for each of the following attributes {Frame Delay, Frame Delay Variation, Frame Loss Ratio, and Availability} for each CoS, where Not Specified (N/S) is an acceptable value.

**Table 16: EVC service attributes and parameters for the EVPL service**

The definition of EVPL in this document is somewhat different than the definition of EVPL used in MEF 6 [1]. The key differences are captured in Table 17.

Attribute	EVPL in this Document	EVPL in MEF 6 [1]
All to One Bundling	Must be No	May be Yes or No

**Table 17: Differences in EVPL from EVPL in MEF 6**

### 7.3 ETHERNET PRIVATE LAN SERVICE

Subscribers with multiple sites often want to interconnect them at high speeds so all sites appear to be on the same Local Area Network (LAN) and have equivalent performance and access to resources such as servers and storage. Subscribers commonly desire a highly transparent service that connects multiple UNIs. To this end, the Ethernet Private LAN (EP-LAN) service is defined in this subsection, using the E-LAN service type.

**The EP-LAN service is defined to provide CE-VLAN tag preservation and tunneling of key Layer 2 Control Protocols. A key advantage of this approach is that the Subscriber can configure VLANs across the sites without any need to coordinate with the Service Provider. Each interface is configured for All to One Bundling and, therefore, EP-LAN service supports CE-VLAN ID**

preservation. In addition, EP-LAN supports CE-VLAN CoS preservation.

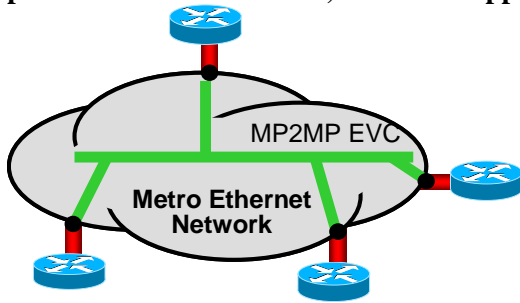
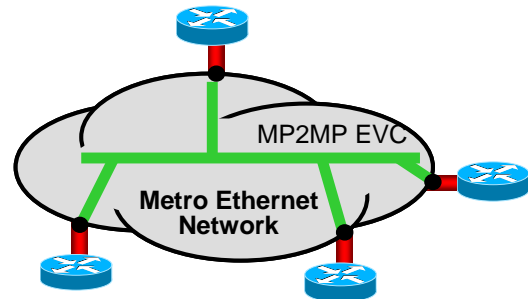

Figure 8 below shows the basic structure of EP-LAN service.



**Figure 8: Ethernet Private LAN (EP-LAN) Service**

Table 18 provides the UNI service attributes, parameters, and values for the EP-LAN service.

UNI Service Attribute	Service Attribute Parameters and Values
UNI Identifier	Arbitrary text string to identify the UNI.
Physical Medium	UNI Type 2 Physical Interface [5] except for PON interfaces
Speed	10 Mbps, 100 Mbps, 10/100 Mbps Auto-negotiation, 10/100/1000 Mbps Auto-negotiation, 1 Gbps, or 10 Gbps
Mode	<b>MUST</b> be Full Duplex
MAC Layer	IEEE 802.3-2005 [5]
UNI MTU Size	<b>MUST</b> be $\geq 1522$
Service Multiplexing	<b>MUST</b> be No
Bundling	<b>MUST</b> be No
All to One Bundling	<b>MUST</b> be Yes
CE-VLAN ID for untagged and priority tagged Service Frames	All untagged and priority tagged Service Frames at the UNI <b>MUST</b> map to the same EVC as is used for all other Service Frames.
Maximum number of EVCs	<b>MUST</b> be 1
Ingress Bandwidth Profile Per UNI	<b>OPTIONAL.</b> If supported, <b>MUST</b> specify <CIR, CBS, EIR, EBS, CM, CF>. <b>MUST NOT</b> be combined with any other type of ingress bandwidth profile.

UNI Service Attribute	Service Attribute Parameters and Values
Egress Bandwidth Profile Per UNI	<b>OPTIONAL.</b> If supported, <b>MUST</b> specify <CIR, CBS, EIR, EBS, CM, CF>. <b>MUST NOT</b> be combined with any other type of egress bandwidth profile.
Layer 2 Control Protocol Processing	<b>MUST</b> specify in accordance with Section 8.3 of this document.

**Table 18: UNI service attributes and parameters for the EP-LAN service**

Table 19 provides the EVC per UNI service attributes, parameters, and values for the EP-LAN service.

EVC per UNI Service Attribute	Service Attribute Parameters and Values
UNI EVC ID	A string formed by the concatenation of the UNI ID and the EVC ID.
CE-VLAN ID / EVC Map	All Service Frames at the UNI <b>MUST</b> map to a single Multipoint-to-Multipoint EVC.
Ingress Bandwidth Profile Per EVC	<b>OPTIONAL.</b> If supported, <b>MUST</b> specify <CIR, CBS, EIR, EBS, CM, CF>. <b>MUST NOT</b> be combined with any other type of ingress bandwidth profile.
Ingress Bandwidth Profile Per CoS ID	<b>OPTIONAL.</b> If supported, <b>MUST</b> specify CoS ID per [2], section 6.8, and <b>MUST</b> specify <CIR, CBS, EIR, EBS, CM, CF> for each CoS. <b>MUST NOT</b> be combined with any other type of ingress bandwidth profile.
Egress Bandwidth Profile Per EVC	<b>OPTIONAL.</b> If supported, <b>MUST</b> specify <CIR, CBS, EIR, EBS, CM, CF>. <b>MUST NOT</b> be combined with any other type of egress bandwidth profile.
Egress Bandwidth Profile Per CoS ID	<b>OPTIONAL.</b> If supported, <b>MUST</b> specify CoS ID per [2], section 6.8, and <b>MUST</b> specify <CIR, CBS, EIR, EBS, CM, CF> for each CoS. <b>MUST NOT</b> be combined with any other type of egress bandwidth profile.

**Table 19: EVC per UNI service attributes and parameters for the EP-LAN service**

Table 20 provides the EVC service attributes, parameters, and values for the EP-LAN service.

EVC Service Attribute	Service Attribute Parameters and Values
EVC Type	<b>MUST</b> be Multipoint-to-Multipoint
EVC ID	An arbitrary string, unique across the MEN, for the EVC supporting the service instance.
UNI List	<b>MUST</b> list the UNIs associated with the EVC. The UNI type <b>MUST</b> be Root for each UNI.
Maximum Number of UNIs	<b>MUST</b> be $\geq 2$
EVC MTU size	<b>MUST</b> be $\geq 1522$ .

EVC Service Attribute	Service Attribute Parameters and Values
CE-VLAN ID Preservation	<b>MUST</b> be Yes
CE-VLAN CoS Preservation	<b>MUST</b> be Yes
Unicast Service Frame Delivery	Deliver Unconditionally or Deliver Conditionally. If Delivered Conditionally, <b>MUST</b> specify the delivery criteria.
Multicast Service Frame Delivery	Deliver Unconditionally or Deliver Conditionally. If Delivered Conditionally, <b>MUST</b> specify the delivery criteria.
Broadcast Service Frame Delivery	Deliver Unconditionally or Deliver Conditionally. If Delivered Conditionally, <b>MUST</b> specify the delivery criteria.
Layer 2 Control Protocols Processing (only applies for L2CPs passed to the EVC)	<b>MUST</b> specify in accordance with Section 8.3 of this document.
EVC Performance	At least one CoS is <b>REQUIRED</b> . <b>MUST</b> specify CoS ID, per section 6.8 of [2]. For each CoS, <b>MUST</b> list values for each of the following attributes {Frame Delay, Frame Delay Variation, Frame Loss Ratio, and Availability}, where Not Specified (N/S) is an acceptable value, for one or more sets of ordered UNI pairs. Each ordered UNI pair in the EVC <b>MUST</b> be mapped to at least one CoS.

**Table 20: EVC service attributes and parameters for the EP-LAN service**

#### 7.4 ETHERNET VIRTUAL PRIVATE LAN SERVICE

Some Subscribers commonly desire an E-LAN service type to connect their UNIs in a metro network, while at the same time accessing other services from one or more of those UNIs. An example of such a UNI is a Subscriber site that wants to access a public or private IP service from a UNI that is also used to for E-LAN service among the Subscriber’s several metro locations. We define the Ethernet Virtual Private LAN (EVP-LAN) service in this subsection to address this need.

Bundling may or may not be used on the UNIs in the Multipoint-to-Multipoint EVC. As such, CE-VLAN tag preservation and tunneling of certain Layer 2 Control Protocols may or may not be provided. Figure 9 below shows the basic structure of EVP-LAN service. In this example, the customer uses an EVP-LAN Service (red EVC) for providing multipoint data connectivity, and an EVPL Service (blue EVC) for accessing value-add services from one of the UNIs.

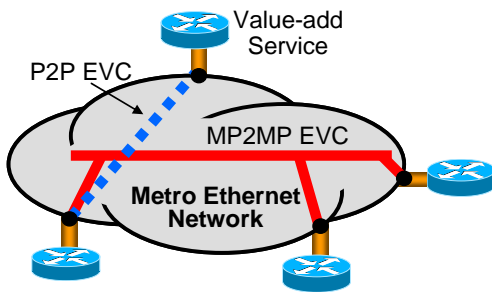

**Figure 9: Ethernet Virtual Private LAN (EVP-LAN) Service**

Table 21 provides the UNI service attributes, parameters, and values for the EVP-LAN service.

UNI Service Attribute	Service Attribute Parameters and Values
UNI Identifier	Arbitrary text string to identify the UNI.
Physical Medium	UNI Type 2 Physical Interface [5] except for PON interfaces
Speed	10 Mbps, 100 Mbps, 10/100 Mbps Auto-negotiation, 10/100/1000 Mbps Auto-negotiation, 1 Gbps, or 10 Gbps
Mode	<b>MUST</b> be Full Duplex
MAC Layer	IEEE 802.3-2005 [5]
UNI MTU Size	<b>MUST</b> be $\geq 1522$
Service Multiplexing	<b>SHOULD</b> be supported at one or more UNIs.
Bundling	Yes or No. If Yes, then CE-VLAN ID Preservation <b>MUST</b> be Yes.
All to One Bundling	<b>MUST</b> be No
CE-VLAN ID for untagged and priority tagged Service Frames	<b>MUST</b> specify CE-VLAN ID for untagged and priority tagged Service Frames in the range of 1-4094.
Maximum number of EVCs	<b>MUST</b> be $\geq 1$
Ingress Bandwidth Profile Per UNI	<b>OPTIONAL</b> . If supported, <b>MUST</b> specify <CIR, CBS, EIR, EBS, CM, CF>. <b>MUST NOT</b> be combined with any other type of ingress bandwidth profile.
Egress Bandwidth Profile Per UNI	<b>OPTIONAL</b> . If supported, <b>MUST</b> specify <CIR, CBS, EIR, EBS, CM, CF>. <b>MUST NOT</b> be combined with any other type of egress bandwidth profile.
Layer 2 Control Protocol Processing	<b>MUST</b> specify in accordance with Section 8.4 of this document.

**Table 21: UNI service attributes and parameters for the EVP-LAN service**

Table 22 provides the EVC per UNI service attributes, parameters, and values for the EVP-LAN service.

EVC per UNI Service Attribute	Service Attribute Parameters and Values
UNI EVC ID	A string formed by the concatenation of the UNI ID and the EVC ID.
CE-VLAN ID / EVC Map	<b>MUST</b> specify mapping table of CE-VLAN IDs to the EVC ID.
Ingress Bandwidth Profile Per EVC	<b>OPTIONAL.</b> If supported, <b>MUST</b> specify <CIR, CBS, EIR, EBS, CM, CF>. <b>MUST NOT</b> be combined with any other ingress bandwidth profile is applied at this UNI for this EVC.
Ingress Bandwidth Profile Per CoS ID	<b>OPTIONAL.</b> If supported, <b>MUST</b> specify CoS ID per [2], section 6.8, and <b>MUST</b> specify <CIR, CBS, EIR, EBS, CM, CF> for each CoS. <b>MUST NOT</b> be combined with any other type of Ingress Bandwidth Profile.
Egress Bandwidth Profile Per EVC	<b>OPTIONAL.</b> <b>MUST</b> specify <CIR, CBS, EIR, EBS, CM, CF> for each CoS. <b>MUST NOT</b> be combined with any other type of egress bandwidth profile.
Egress Bandwidth Profile Per CoS ID	<b>OPTIONAL.</b> If supported, <b>MUST</b> specify CoS ID per [2], section 6.8, and <b>MUST</b> specify <CIR, CBS, EIR, EBS, CM, CF>. <b>MUST NOT</b> be combined with any other type of egress bandwidth profile.

**Table 22: EVC per UNI service attributes and parameters for the EVP-LAN service**

Table 23 provides the EVC service attributes, parameters, and values for the EVP-LAN service.

EVC Service Attribute	Service Attribute Parameters and Values
EVC Type	<b>MUST</b> be Multipoint-to-Multipoint
EVC ID	An arbitrary string, unique across the MEN, for the EVC supporting the service instance.
UNI List	<b>MUST</b> list the UNIs associated with the EVC. The UNI type <b>MUST</b> be Root for each UNI.
Maximum Number of UNIs	<b>MUST</b> be $\geq 2$
EVC MTU size	<b>MUST</b> be $\geq 1522$
CE-VLAN ID Preservation	<b>MUST</b> be either Yes or No
CE-VLAN CoS Preservation	<b>MUST</b> be either Yes or No
Unicast Service Frame Delivery	Deliver Unconditionally or Deliver Conditionally. If Delivered Conditionally, <b>MUST</b> specify the delivery criteria.
Multicast Service Frame Delivery	Deliver Unconditionally or Deliver Conditionally. If Delivered Conditionally, <b>MUST</b> specify the delivery criteria.
Broadcast Service Frame Delivery	Deliver Unconditionally or Deliver Conditionally. If Delivered Conditionally, <b>MUST</b> specify the delivery criteria.



EVC Service Attribute	Service Attribute Parameters and Values
Layer 2 Control Protocols Processing (only applies for L2CPs passed to the EVC)	<b>MUST</b> specify in accordance with Section 8.4 of this document.
EVC Performance	At least one CoS is <b>REQUIRED</b> . <b>MUST</b> specify CoS ID, per section 6.8 of [2]. For each CoS, <b>MUST</b> list values for each of the following attributes {Frame Delay, Frame Delay Variation, Frame Loss Ratio, and Availability}, where Not Specified (N/S) is an acceptable value, for one or more sets of ordered UNI pairs. Each ordered UNI pair in the EVC <b>MUST</b> be mapped to at least one CoS.

Table 23: EVC service attributes and parameters for the EVP-LAN service

### 7.5 ETHERNET PRIVATE TREE SERVICE

Subscribers with multiple sites may want to interconnect them to provide services other than those that resemble a LAN. These services may be distributed from a centralized site (or few such sites) where the distribution site is designated as a Root and all the remaining sites are designated as leaves.

The EP-Tree service is defined to provide CE-VLAN tag preservation and tunneling of key Layer 2 Control Protocols. A key advantage of this approach is that the Subscriber can configure VLANs across the sites without any need to coordinate with the Service Provider. Each interface is configured for All to One Bundling and, therefore, EP-Tree service supports CE-VLAN ID preservation. In addition, EP-Tree supports CE-VLAN CoS preservation.

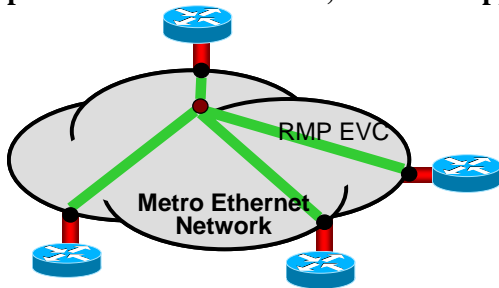

Figure 10 below shows the basic structure of EP-Tree service.

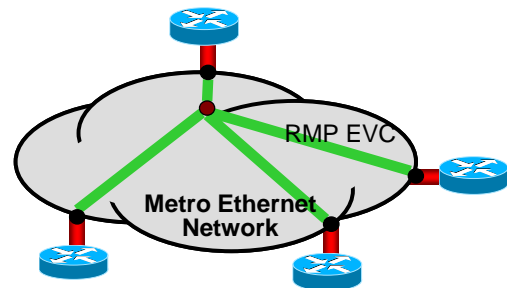

Figure 10: Ethernet Private Tree (EP-Tree) Service

Table 24 provides the UNI service attributes, parameters, and values for the EP- Tree service.

UNI Service Attribute	Service Attribute Parameters and Values
UNI Identifier	Arbitrary text string to identify the UNI.
Physical Medium	UNI Type 2 Physical Interface [5] except for PON interfaces
Speed	10 Mbps, 100 Mbps, 10/100 Mbps Auto-negotiation, 10/100/1000 Mbps Auto-negotiation, 1 Gbps, or 10 Gbps
Mode	<b>MUST</b> be Full Duplex
MAC Layer	IEEE 802.3-2005 [5]
UNI MTU Size	<b>MUST</b> be $\geq 1522$
Service Multiplexing	<b>MUST</b> be No
Bundling	<b>MUST</b> be No
All to One Bundling	<b>MUST</b> be Yes
CE-VLAN ID for untagged and priority tagged Service Frames	All untagged and priority tagged Service Frames at the UNI <b>MUST</b> map to the same EVC as is used for all other Service Frames.
Maximum number of EVCs	<b>MUST</b> be 1
Ingress Bandwidth Profile Per UNI	<b>OPTIONAL</b> . If supported, <b>MUST</b> specify <CIR, CBS, EIR, EBS, CM, CF>. <b>MUST NOT</b> combined with any other type of ingress bandwidth profile.
Egress Bandwidth Profile Per UNI	<b>OPTIONAL</b> . If supported, <b>MUST</b> specify <CIR, CBS, EIR, EBS, CM, CF>. <b>MUST NOT</b> be combined with any other type of egress bandwidth profile.
Layer 2 Control Protocol Processing	<b>MUST</b> specify in accordance with Section 8.5 of this document.

**Table 24: UNI service attributes and parameters for the EP-Tree service**

Table 25 provides the EVC per UNI service attributes, parameters, and values for the EP- Tree service.

EVC per UNI Service Attribute	Service Attribute Parameters and Values
UNI EVC ID	A string formed by the concatenation of the UNI ID and the EVC ID.
CE-VLAN ID / EVC Map	All Service Frames at the UNI <b>MUST</b> map to the Rooted-Multipoint EVC.
Ingress Bandwidth Profile Per EVC	<b>OPTIONAL</b> . If supported, <b>MUST</b> specify <CIR, CBS, EIR, EBS, CM, CF>. <b>MUST NOT</b> be combined with any other type of ingress bandwidth profile.
Ingress Bandwidth Profile Per CoS ID	<b>OPTIONAL</b> . If supported, <b>MUST</b> specify CoS ID per [2], section 6.8, and <b>MUST</b> specify <CIR, CBS, EIR, EBS, CM, CF> for each CoS. <b>MUST NOT</b> be combined with any other type of ingress bandwidth profile.

EVC per UNI Service Attribute	Service Attribute Parameters and Values
Egress Bandwidth Profile Per EVC	<b>OPTIONAL.</b> If supported, <b>MUST</b> specify <CIR, CBS, EIR, EBS, CM, CF>. <b>MUST NOT</b> be combined with any other type of egress bandwidth profile.
Egress Bandwidth Profile Per CoS ID	<b>OPTIONAL.</b> If supported, <b>MUST</b> specify CoS ID per [2], section 6.8, and <b>MUST</b> specify <CIR, CBS, EIR, EBS, CM, CF> for each CoS. <b>MUST NOT</b> be combined with any other type of egress bandwidth profile.

**Table 25: EVC per UNI service attributes and parameters for the EP-Tree service**

Table 26 provides the EVC service attributes, parameters, and values for the EP-Tree service.

EVC Service Attribute	Service Attribute Parameters and Values
EVC Type	<b>MUST</b> be Rooted-Multipoint
EVC ID	An arbitrary string, unique across the MEN, for the EVC supporting the service instance.
UNI List	<b>MUST</b> list the UNIs associated with the EVC. The UNI Type for at least 1 UNI <b>MUST</b> be Root. All UNIs that are not UNI Type Root <b>MUST</b> be UNI Type Leaf.
Maximum Number of UNIs	<b>MUST</b> be $\geq 2$
EVC MTU size	<b>MUST</b> be $\geq 1522$
CE-VLAN ID Preservation	<b>MUST</b> be Yes
CE-VLAN CoS Preservation	<b>MUST</b> be Yes
Unicast Service Frame Delivery	Deliver Unconditionally or Deliver Conditionally. If Delivered Conditionally, <b>MUST</b> specify the delivery criteria.
Multicast Service Frame Delivery	Deliver Unconditionally or Deliver Conditionally. If Delivered Conditionally, <b>MUST</b> specify the delivery criteria.
Broadcast Service Frame Delivery	Deliver Unconditionally or Deliver Conditionally. If Delivered Conditionally, <b>MUST</b> specify the delivery criteria.
Layer 2 Control Protocols Processing (only applies for L2CP frames passed to the EVC)	<b>MUST</b> specify in accordance with Section 8.5 of this document.
EVC Performance	At least one CoS is <b>REQUIRED</b> . <b>MUST</b> specify CoS ID, per section 6.8 of [2]. For each CoS, <b>MUST</b> list values for each of the following attributes {Frame Delay, Frame Delay Variation, Frame Loss Ratio, and Availability}, where Not Specified (N/S) is an acceptable value, for one or more sets of ordered UNI pairs where each ordered pair contains at least one Root UNI. Each ordered UNI pair containing at least one Root UNI in the EVC <b>MUST</b> be mapped to at least one CoS.

**Table 26: EVC service attributes and parameters for the EP-Tree service**

**7.6 ETHERNET VIRTUAL PRIVATE TREE SERVICE**

Some subscribers desire access to certain applications or content services from well-defined access points within their own (or an external) network. In this case it is necessary to interconnect the participating UNIs in a Rooted-Multipoint connection to the well-defined access (or root) point. One or more of the Subscriber’s UNIs may also support other services, e.g., EVPL or EVP-LAN. For such cases, the EVP-Tree service is used.

Bundling may or may not be used on the UNIs in the Rooted-Multipoint EVC. As such, CE-VLAN tag preservation and tunneling of certain Layer 2 Control Protocols may or may not be provided. Figure 11 below shows the basic structure of EVP-Tree service. In this example, a customer has EVP-LAN service (red EVC) providing data connectivity among three UNIs, while using EVP-Tree service (green EVC) for providing video broadcast from a video hub location.

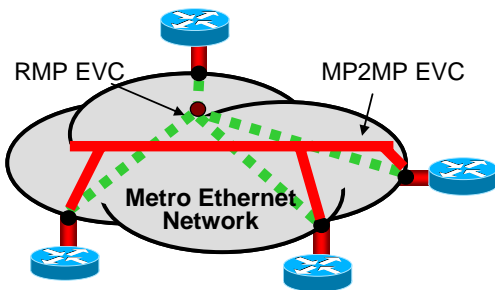

**Figure 11: Ethernet Virtual Private Tree (EVP-Tree) Service**

Table 27 provides the UNI service attributes, parameters, and values for the EVP-Tree service.

UNI Service Attribute	Service Attribute Parameters and Values
UNI Identifier	Arbitrary text string to identify the UNI.
Physical Medium	UNI Type 2 Physical Interface [5] except for PON interfaces
Speed	10 Mbps, 100 Mbps, 10/100 Mbps Auto-negotiation, 10/100/1000 Mbps Auto-negotiation, 1 Gbps, or 10 Gbps
Mode	<b>MUST</b> be Full Duplex
MAC Layer	IEEE 802.3-2005 [5]
UNI MTU Size	<b>MUST</b> be $\geq 1522$
Service Multiplexing	<b>SHOULD</b> be supported at one or more UNIs.
Bundling	Yes or No. If Yes, then CE-VLAN ID Preservation <b>MUST</b> be Yes.
All to One Bundling	<b>MUST</b> be No
CE-VLAN ID for untagged and priority tagged Service Frames	<b>MUST</b> specify CE-VLAN ID for untagged and priority tagged Service Frames in the range of 1-4094.
Maximum number of EVCs	<b>MUST</b> be $\geq 1$

UNI Service Attribute	Service Attribute Parameters and Values
Ingress Bandwidth Profile Per UNI	<b>OPTIONAL.</b> If supported, <b>MUST</b> specify <CIR, CBS, EIR, EBS, CM, CF>. <b>MUST NOT</b> be combined with any other type of ingress bandwidth profile.
Egress Bandwidth Profile Per UNI	<b>OPTIONAL.</b> If supported, <b>MUST</b> specify <CIR, CBS, EIR, EBS, CM, CF>. <b>MUST NOT</b> be combined with any other type of egress bandwidth profile.
Layer 2 Control Protocol Processing	<b>MUST</b> specify in accordance with Section 8.6 of this document.

**Table 27: UNI service attributes and parameters for the EVP-Tree service**

Table 28 provides the EVC per UNI service attributes, parameters, and values for the EVP-Tree service.

EVC per UNI Service Attribute	Service Attribute Parameters and Values
UNI EVC ID	A string formed by the concatenation of the UNI ID and the EVC ID.
CE-VLAN ID / EVC Map	<b>MUST</b> specify mapping table of CE-VLAN IDs to the EVC ID.
Ingress Bandwidth Profile Per EVC	<b>OPTIONAL.</b> If supported, <b>MUST</b> specify <CIR, CBS, EIR, EBS, CM, CF>. <b>MUST NOT</b> be combined with any other type of ingress bandwidth profile.
Ingress Bandwidth Profile Per CoS ID	<b>OPTIONAL.</b> If supported, <b>MUST</b> specify CoS ID per [2], section 6.8, and <b>MUST</b> specify <CIR, CBS, EIR, EBS, CM, CF> for each CoS. <b>MUST NOT</b> be combined with any other type of ingress bandwidth profile.
Egress Bandwidth Profile Per EVC	<b>OPTIONAL.</b> If supported, <b>MUST</b> specify <CIR, CBS, EIR, EBS, CM, CF>. <b>MUST NOT</b> be combined with any other type of egress bandwidth profile.
Egress Bandwidth Profile Per CoS ID	<b>OPTIONAL.</b> If supported, <b>MUST</b> specify CoS ID per [2], section 6.8, and <b>MUST</b> specify <CIR, CBS, EIR, EBS, CM, CF> for each CoS. <b>MUST NOT</b> be combined with any other type of egress bandwidth profile.

**Table 28: EVC per UNI service attributes and parameters for the EVP-Tree service**

Table 29 provides the EVC service attributes, parameters, and values for the EVP-Tree service.

EVC Service Attribute	Service Attribute Parameters and Values
EVC Type	<b>MUST</b> be Rooted-Multipoint
EVC ID	An arbitrary string, unique across the MEN, for the EVC supporting the service instance.
UNI List	<b>MUST</b> list the UNIs associated with the EVC. The UNI Type for at least 1 UNI <b>MUST</b> be Root. All UNIs that are not UNI Type Root <b>MUST</b> be UNI Type Leaf.
Maximum Number of UNIs	<b>MUST</b> be $\geq 2$
EVC MTU size	<b>MUST</b> be $\geq 1522$

EVC Service Attribute	Service Attribute Parameters and Values
CE-VLAN ID Preservation	<b>MUST</b> be either Yes or No
CE-VLAN CoS Preservation	<b>MUST</b> be either Yes or No
Unicast Service Frame Delivery	Deliver Unconditionally or Deliver Conditionally. If Delivered Conditionally, <b>MUST</b> specify the delivery criteria.
Multicast Service Frame Delivery	Deliver Unconditionally or Deliver Conditionally. If Delivered Conditionally, <b>MUST</b> specify the delivery criteria.
Broadcast Service Frame Delivery	Deliver Unconditionally or Deliver Conditionally. If Delivered Conditionally, <b>MUST</b> specify the delivery criteria.
Layer 2 Control Protocols Processing (only applies for L2CP frame passed to the EVC)	<b>MUST</b> specify in accordance with Section 8.6 of this document.
EVC Performance	At least one CoS is <b>REQUIRED</b> . <b>MUST</b> specify CoS ID, per section 6.8 of [2]. For each CoS, <b>MUST</b> list values for each of the following attributes {Frame Delay, Frame Delay Variation, Frame Loss Ratio, and Availability}, where Not Specified (N/S) is an acceptable value, for one or more sets of ordered UNI pairs where each ordered pair contains at least one Root UNI. Each ordered UNI pair containing at least one Root UNI in the EVC <b>MUST</b> be mapped to at least one CoS.

**Table 29: EVC service attributes and parameters for the EVP-Tree service**

## 8. Layer 2 Control Protocol Processing Requirements (Normative)

This section provides requirements for the processing of a Subscriber’s Layer 2 Control Protocol (L2CP) frames on a given UNI for the services defined in this document. The requirements are intended to provide guidance for actual deployments of the Ethernet services defined in this document, while at the same time allowing for flexibility among the Service Provider offerings.

Within the context of this document, a Layer 2 Control Protocol is identified by one of the following MAC Destination Addresses:

MAC DAs	Layer 2 Control Protocol
01-80-C2-00-00-00 through 01-80-C2-00-00-0F	Bridge Block of protocols
01-80-C2-00-00-20 through 01-80-C2-00-00-2F	GARP Block of protocols

**Table 30: List of Standardized Layer 2 Control Protocols**

For each service, protocols are configured to ‘tunnel’, ‘peer’, or ‘discard’ at the UNI. Classification of which L2CP frames to tunnel will examine only the MAC Destination Address (DA) of the Service Frame. Note that for cases in which more than one protocol uses the same MAC DA (e.g., LACP and Link OAM), then the required action related to tunneling is the same. Since multiple protocols may share the same MAC DA, classification of which L2CP frames to peer will examine both the MAC DA and the protocol identifiers (e.g. Ethertype, Slow-protocol sub-type).

In this section, ‘Discard’ means that the MEN will discard ingress L2CP frames of a given <protocol, DA> pair and will not generate that <protocol, DA> pair on egress from the MEN. ‘Peer’ means that the MEN will actively participate with the protocol if the DA is as specified. These L2CPs are: LACP/LAMP, Link OAM, Port Authentication, and E-LMI. ‘Tunnel’ means that frames are transparently passed to a given EVC for transport across the MEN to the destination UNI(s).

If a given protocol uses a MAC Destination Address (DA) other than that specified in the following subsections, and outside the block of the reserved MAC DAs (16 bridge block, 16 GARP block), then it **SHOULD** be treated as normal data.

If a given protocol uses a MAC DA other than that specified in the following subsections, but within the block of the reserved MAC DAs (16 bridge block, 16 GARP block), then the requirements are left for further study.

These recommendations are designed to be consistent with a standard Provider Bridge [10] implementation. The Provider Bridge specification allows for subscribers that may want to deviate from these recommendations by providing a default set of standard destination MAC addresses that could be used to determine either peering or tunneling for a specific L2CP. See Section 11, for more discussion of how the MEF terminology maps to IEEE 802.1 terminology with respect to L2CP processing.

The tables in the following subsections summarize the Layer 2 Control Protocol (L2CP) Processing requirements for the indicated services. For an ingress Service Frame with the given destination MAC address and the given protocol, the required actions for the service are specified together with the applicability of the requirement, i.e., whether it applies to all UNIs in the EVC or is applied on a per-UNI basis.

Please note that while [1] included requirements for ‘All Bridges’, requirements for this protocol are not included in this document. The All LANs Bridge Management Group Address (01-80-C2-00-00-10) has been officially deprecated in 802.1Q-2005, subclause 8.13.7. In the unlikely event that a customer may use this MAC DA, MEF services are expected to treat them as normal service frames.

**8.1 L2CP REQUIREMENTS FOR ETHERNET PRIVATE LINE (EPL) SERVICE**

Table 31 specifies the L2CP processing requirements for EPL service. The first column identifies the standard protocol, and the second column identifies the MAC DA used to carry that protocol data unit. The third column specifies the required action, and the fourth column specifies the applicability, i.e., whether the action taken must be the same at all UNIs in the EVC, or the action taken can be different on different UNIs in the EVC.

Protocol	MAC DA	L2CP Requirement		Applicability
		Option 1	Option 2	
STP[3]/RSTP[3]/MSTP[4]	01-80-C2-00-00-00	<b>MUST</b> Tunnel	<b>MUST</b> Tunnel	All UNIs in the EVC

PAUSE[5]	01-80-C2-00-00-01	<b>SHOULD</b> Discard	<b>SHOULD</b> Discard	All UNIs in the EVC
LACP/LAMP[5]	01-80-C2-00-00-02	<b>SHOULD</b> Peer or Discard	<b>SHOULD</b> Tunnel	Option 1: Per UNI Option 2: All UNIs in the EVC
Link OAM[5]	01-80-C2-00-00-02	<b>SHOULD</b> Peer or Discard	<b>SHOULD</b> Tunnel	Option 1: Per UNI Option 2: All UNIs in the EVC
Port Authentication[7]	01-80-C2-00-00-03	<b>SHOULD</b> Peer or Discard	<b>SHOULD</b> Tunnel	Option 1: Per UNI Option 2: All UNIs in the EVC
E-LMI[9]	01-80-C2-00-00-07	<b>SHOULD</b> Peer or Discard	<b>MUST</b> Tunnel	Option 1: Per UNI Option 2: All UNIs in the EVC
LLDP[8]	01-80-C2-00-00-0E	<b>SHOULD</b> Discard	<b>MUST</b> Tunnel	All UNIs in the EVC
GARP[4]/MRP[17] Block	01-80-C2-00-00-20 through 01-80-C2-00-00-2F	<b>MUST</b> Discard or Tunnel	<b>MUST</b> Tunnel	All UNIs in the EVC

**Table 31: L2CP Processing Requirements for the EPL Service**

## 8.2 L2CP REQUIREMENTS FOR ETHERNET VIRTUAL PRIVATE LINE (EVPL) SERVICE

Table 32 specifies the L2CP processing requirements for EVPL service. The first column identifies the standard protocol, and the second column identifies the MAC DA used to carry that protocol data unit. The third column specifies the required action, and the fourth column specifies the applicability, i.e., whether the action taken must be the same at all UNIs in the EVC, or the action taken can be different on different UNIs in the EVC.

Protocol	MAC DA	L2CP Requirement	Applicability
STP[3]/RSTP[3]/MSTP[4]	01-80-C2-00-00-00	<b>MUST</b> Peer or Discard	All UNIs in the EVC
PAUSE[5]	01-80-C2-00-00-01	<b>MUST</b> Discard	All UNIs in the EVC
LACP/LAMP[5]	01-80-C2-00-00-02	<b>MUST</b> Peer or Discard	Per UNI
Link OAM[5]	01-80-C2-00-00-02	<b>MUST</b> Peer or Discard	Per UNI
Port Authentication[7]	01-80-C2-00-00-03	<b>MUST</b> Peer or Discard	Per UNI
E-LMI[9]	01-80-C2-00-00-07	<b>MUST</b> Peer or Discard	Per UNI
LLDP[8]	01-80-C2-00-00-0E	<b>MUST</b> Discard	All UNIs in the EVC
GARP[4]/MRP[17] Block	01-80-C2-00-00-20 through 01-80-C2-00-00-2F	<b>MUST</b> Peer, Tunnel or Discard	Per UNI

**Table 32: L2CP Processing Requirements for the EVPL Service**

## 8.3 L2CP REQUIREMENTS FOR ETHERNET PRIVATE LAN (EP-LAN) SERVICE

Table 33 specifies the L2CP processing requirements for EP-LAN service. The first column identifies the standard protocol, and the second column identifies the MAC DA used to carry that



protocol data unit. The third column specifies the required action, and the fourth column specifies the applicability, i.e., whether the action taken must be the same at all UNIs in the EVC, or the action taken can be different on different UNIs in the EVC.

Protocol	MAC DA	L2CP Requirement	Applicability
STP[3]/RSTP[3]/MSTP[4]	01-80-C2-00-00-00	<b>SHOULD</b> Tunnel <b>MAY</b> Discard	All UNIs in the EVC
PAUSE[5]	01-80-C2-00-00-01	<b>MUST</b> Discard	All UNIs in the EVC
LACP/LAMP[5]	01-80-C2-00-00-02	<b>MUST</b> Peer or Discard	Per UNI
Link OAM[5]	01-80-C2-00-00-02	<b>MUST</b> Peer or Discard	Per UNI
Port Authentication[7]	01-80-C2-00-00-03	<b>MUST</b> Peer or Discard	Per UNI
E-LMI[9]	01-80-C2-00-00-07	<b>MUST</b> Peer or Discard	Per UNI
LLDP[8]	01-80-C2-00-00-0E	<b>MUST</b> Discard	All UNIs in the EVC
GARP[4]/MRP[17] Block	01-80-C2-00-00-20 through 01-80-C2-00-00-2F	<b>MUST</b> Peer, Tunnel or Discard	Per UNI

**Table 33: L2CP Processing Requirements for the EP-LAN Service**

#### 8.4 L2CP REQUIREMENTS FOR ETHERNET VIRTUAL PRIVATE LAN (EVP-LAN) SERVICE

Table 34 specifies the L2CP processing requirements for EVP-LAN service. The first column identifies the standard protocol, and the second column identifies the MAC DA used to carry that protocol data unit. The third column specifies the required action, and the fourth column specifies the applicability, i.e., whether the action taken must be the same at all UNIs in the EVC, or the action taken can be different on different UNIs in the EVC.

Protocol	MAC DA	L2CP Requirement	Applicability
STP[3]/RSTP[3]/MSTP[4]	01-80-C2-00-00-00	<b>MUST</b> Peer or Discard	All UNIs in the EVC
PAUSE[5]	01-80-C2-00-00-01	<b>MUST</b> Discard	All UNIs in the EVC
LACP/LAMP[5]	01-80-C2-00-00-02	<b>MUST</b> Peer or Discard	Per UNI
Link OAM[5]	01-80-C2-00-00-02	<b>MUST</b> Peer or Discard	Per UNI
Port Authentication[7]	01-80-C2-00-00-03	<b>MUST</b> Peer or Discard	Per UNI
E-LMI[9]	01-80-C2-00-00-07	<b>MUST</b> Peer or Discard	Per UNI
LLDP[8]	01-80-C2-00-00-0E	<b>MUST</b> Discard	All UNIs in the EVC
GARP[4]/MRP[17] Block	01-80-C2-00-00-20 through 01-80-C2-00-00-2F	<b>MUST</b> Peer, Tunnel or Discard	Per UNI

**Table 34: L2CP Processing Requirements for the EVP-LAN Service**

#### 8.5 L2CP REQUIREMENTS FOR ETHERNET PRIVATE TREE (EP-TREE) SERVICE

Table 35 specifies the L2CP processing requirements for EP-Tree service. The first column identifies the standard protocol, and the second column identifies the MAC DA used to carry that protocol data unit. The third column specifies the required action, and the fourth column

specifies the applicability, i.e., whether the action taken must be the same at all UNIs in the EVC, or the action taken can be different on different UNIs in the EVC.

Protocol	MAC DA	L2CP Requirement	Applicability
STP[3]/RSTP[3]/MSTP[4]	01-80-C2-00-00-00	<b>SHOULD</b> Tunnel <sup>6</sup> <b>MAY</b> Discard	All UNIs in the EVC
PAUSE[5]	01-80-C2-00-00-01	<b>MUST</b> Discard	All UNIs in the EVC
LACP/LAMP[5]	01-80-C2-00-00-02	<b>MUST</b> Peer or Discard	Per UNI
Link OAM[5]	01-80-C2-00-00-02	<b>MUST</b> Peer or Discard	Per UNI
Port Authentication[7]	01-80-C2-00-00-03	<b>MUST</b> Peer or Discard	Per UNI
E-LMI[9]	01-80-C2-00-00-07	<b>MUST</b> Peer or Discard	Per UNI
LLDP[8]	01-80-C2-00-00-0E	<b>MUST</b> Discard	All UNIs in the EVC
GARP[4]/MRP[17] Block	01-80-C2-00-00-20 through 01-80-C2-00-00-2F	<b>MUST</b> Peer, Tunnel or Discard	Per UNI

**Table 35: L2CP Processing Requirements for the EP-Tree Service**

## 8.6 L2CP REQUIREMENTS FOR ETHERNET VIRTUAL PRIVATE TREE (EVP-TREE) SERVICE

Table 36 specifies the L2CP processing requirements for EVP-Tree service. The first column identifies the standard protocol, and the second column identifies the MAC DA used to carry that protocol data unit. The third column specifies the required action, and the fourth column specifies the applicability, i.e., whether the action taken must be the same at all UNIs in the EVC, or the action taken can be different on different UNIs in the EVC.

Protocol	MAC DA	L2CP Requirement	Applicability
STP[3]/RSTP[3]/MSTP[4]	01-80-C2-00-00-00	<b>MUST</b> Peer or Discard	All UNIs in the EVC
PAUSE[5]	01-80-C2-00-00-01	<b>MUST</b> Discard	All UNIs in the EVC
LACP/LAMP[5]	01-80-C2-00-00-02	<b>MUST</b> Peer or Discard	Per UNI
Link OAM[5]	01-80-C2-00-00-02	<b>MUST</b> Peer or Discard	Per UNI
Port Authentication[7]	01-80-C2-00-00-03	<b>MUST</b> Peer or Discard	Per UNI
E-LMI[9]	01-80-C2-00-00-07	<b>MUST</b> Peer or Discard	Per UNI
LLDP[8]	01-80-C2-00-00-0E	<b>MUST</b> Discard	All UNIs in the EVC
GARP[4]/MRP[17] Block	01-80-C2-00-00-20 through 01-80-C2-00-00-2F	<b>MUST</b> Peer, Tunnel or Discard	Per UNI

**Table 36: L2CP Processing Requirements for the EVP-Tree Service**

<sup>6</sup> Since not all CEs in an E-Tree service will see all BPDUs, undesirable behavior can ensue. Service Providers should be careful to warn Subscribers about attaching bridges to such a service and expecting STP work properly.

## 9. Service OAM Requirements (Normative)

Service OAM requirements in this section are in alignment with MEF Service OAM Requirements & Framework - Phase 1 [16], and are based on protocols specified in IEEE 802.1ag [11] and ITU-T Y.1731 [15]. This is a set of protocols that allow for two types of maintenance points and up to eight Maintenance Domains (MD's) associated with a given service.

A Maintenance End Point (MEP) is used at the edge of a domain to control management of a given service. A Maintenance Intermediate Point (MIP) is used within the domain, between MEPs, to aid in operating and maintaining the service.

The eight Maintenance Domain (MD) levels are grouped, as follows:

- **Subscriber MD:** The Subscriber MD, typically at levels 5-7, are allocated for the Subscriber to use for managing the service within the Subscriber's domain, e.g., from CE to CE.
- **Service Provider MD:** The Service Provider MD, typically at levels 3-4, are allocated for the Service Provider to use for managing the service within the Service Provider's domain, e.g., from UNI-to-UNI.
- **Operator MD:** The Operator MD, typically at levels 1-2, are allocated for the Operator to use for managing the service from within the Operator's domain.
- **UNI Maintenance Entity (UNI ME):** The UNI ME, typically at level 0, is allocated for managing the UNI link.

For the purpose of this section, only the Subscriber MD is considered. The Service Provider and Operator MDs do not cross the UNI, hence are not involved in the definitions of the Ethernet Services. In addition, requirements for the UNI ME will be addressed in future MEF Implementation Agreements.

The Service Provider and Subscriber **SHOULD** agree on the allocation of one or more Subscriber MD levels for a given Ethernet service.

Since the higher MD levels have wider scope, the agreed Subscriber MD levels **MUST** be higher than any MD-levels used by the Service Provider to monitor that EVC.

For example, a Service Provider and Subscriber could agree on two Subscriber MD levels and, therefore, agree on MD levels 6 and 7 for use by the Subscriber. This would leave MD level 5 for possible use by the Service Provider, in addition to the Service Provider MD levels outlined before.

Also, a Service Provider **MAY** configure MIPs in the MEN at the lowest agreed Subscriber MD level.

Requirements for the agreed upon Subscriber MD levels are specified in the following subsections for each of three protocols: Continuity Check, Link Trace, and Loopback.

### 9.1.1 *Subscriber MD, Continuity Check*

The Subscriber MD Continuity Check (CC) function allows the Subscriber to check continuity for a given EVC across the entire service using a CC Message (CCM), sent from one MEP to another MEP. For services with more than two MEPs, CCMs would be enabled on all MEPs, such that each MEP would send CCMs to all of its peers.

A Subscriber could send CCMs at a fast rate to quickly detect service failures, and perhaps switch the service to a back-up protected path. Another use case could be to use CCMs at a slower rate, and use the results to track the service performance. A third use case is to use CCMs for basic fault management, i.e., detecting loss of continuity or unintended connectivity among MEPs.

The MAC Destination Addresses reserved for CCMs at MD levels 0-7 are specified in IEEE 802.1ag [11].

Since MIPs are not involved in processing the Subscriber MD CCMs, the Service Provider can play no role in this protocol, other than tunneling it. Thus, for any of the Ethernet services defined in this document, a CCM at an agreed upon Subscriber MD level with the corresponding MAC Destination Address **MUST** be tunneled.

The following requirements are specified to determine the CoS of a tunneled Subscriber MD level CCM.

For an EVC with a single CoS, the tunneled CCM frame **MUST** use the CoS of the EVC.

For an EVC with multiple CoS, the requirements are dependent on the Class of Service Identification (CoS ID) used for a given EVC.

- Where PCP is used for CoS ID, the CoS for a tunneled CCM frame **MUST** be determined solely by the PCP field of the CCM frame. The Subscriber **SHOULD** map Subscriber MD level CCMs to a PCP value that results in a CoS with the lowest loss.
- Where DSCP is used for CoS ID, the CoS ID for a tunneled CCM frame **SHOULD** be agreed upon by the Subscriber and Service Provider (the same CoS ID for all non-IP packets).

### 9.1.2 *Subscriber MD, Link Trace*

The Subscriber MD Link Trace (LT) function allows the Subscriber to trace the path for a given EVC across the entire service using a LT Message (LTM), which is sent on demand from one MEP towards a target MEP (or a target MIP). If a MIP is configured inside the MEN at the same MD level as set in the LTM, the MIP would respond with a LT Response (LTR) to the source

MEP, and relay the original LTM towards the target, with the TTL field decremented. We refer to this process as peering. If there is no MIP configured inside the MEN, then the LTM is expected to be tunneled through the service.

The MAC Destination Addresses reserved for LTs at MD levels 0-7 are specified in IEEE 802.1ag [11].

There are two sets of requirements for LT. The first scenario is where one or more MIPs are configured in the MEN at an agreed Subscriber MD level. The other is the case where a MIP is not configured in the MEN at an agreed Subscriber MD level.

For any of the Ethernet services defined in this document where at least one MIP is configured inside the MEN at an agreed Subscriber MD level, a LT message at an agreed upon Subscriber MD level with the corresponding MAC Destination Address **MUST** be peered or discarded. For link trace, peering means that the MIP responds and the LT message is forwarded per the Service OAM standards.

For any of the Ethernet services defined in this document where a MIP is not configured in the MEN at an agreed Subscriber MD level, a LT message at an agreed upon Subscriber MD level with the corresponding MAC Destination Address **MUST** be tunneled.

### **9.1.3 Subscriber MD, Loopback**

The Subscriber MD Loopback (LB) function allows the Subscriber to ping a target MEP or MIP using an LB Message (LBM), which is sent on demand from one MEP towards the target MEP or MIP. If a MIP is configured inside the MEN at the same MD level as set in the LBM, and if the target for the LBM is the MIP itself, then the MIP would respond with a LB Response (LBR) to the source MEP. We refer to this process as peering. If there is no MIP configured inside the MEN, or if the target for the LBM is not any of the MIPs inside the MEN, then the LBM is expected to be tunneled through the service.

An LBM may be sent with a unicast or multicast DA. In the case of multicast LBM, the MAC DA values are the same as those for CCM. An LBR always uses a unicast DA. For cases where a multicast DA is used in the LBM frame, the target is all MEPs in the MD. Any MIP along the path is expected to ignore (relay) such a frame.

There are three sets of requirements for LB. The first scenario is where the Subscriber uses a unicast MAC DA for the target and one or more MIPs are configured in the MEN at an agreed Subscriber MD level. The second case is where the Subscriber uses a unicast MAC DA for the target and a MIP is not configured in the MEN at an agreed Subscriber MD level. The third case is where the Subscriber uses a multicast MAC DA for the target, regardless of whether there is a MIP at an agreed Subscriber MD level or not configured in the MEN.

For any of the Ethernet services defined in this document where the Subscriber uses a unicast MAC DA for the target and at least one MIP is configured inside the MEN at an agreed

Subscriber MD level, a LB message at an agreed upon Subscriber MD level with a target unicast DA equal to the MAC address of a MIP in the MEN **MUST** be peered or discarded. Such a control mechanism could be used by a Service Provider to minimize the impact of LBMs on the MEN. A LB message at an agreed upon Subscriber MD level with a target unicast DA not equal to the MAC address of any MIP inside the MEN **MUST** be tunneled.

For any of the Ethernet services defined in this document where the Subscriber uses a unicast MAC DA for the target and a MIP is not configured inside the MEN at an agreed Subscriber MD level, a LB message at an agreed upon Subscriber MD level **MUST** be tunneled.

For any of the Ethernet services defined in this document where the Subscriber uses a multicast MAC DA for the target, a LB message at an agreed upon Subscriber MD level with the corresponding MAC DA **MUST** be tunneled.

## 10. References

- [1] MEF Technical Specification MEF 6, “Ethernet Services Definitions - Phase I”, June 2004
- [2] MEF Technical Specification, MEF 10.1, “Ethernet Services Attributes - Phase 2”, November 2006
- [3] IEEE 802.1D-2004, “Part 3: Media Access Control (MAC) Bridges”
- [4] IEEE 802.1Q – 2005, “Virtual Bridged Local Area Networks”
- [5] IEEE 802.3-2005, “Part 3: Carrier sense multiple access with collision detection (CSMA/CD) access method and physical layer specifications”
- [6] RFC 2119, “Key words for use in RFCs to Indicate Requirement Levels”, S. Bradner
- [7] IEEE 802.1X – 2004, “Port-Based Network Access Control”
- [8] IEEE 802.1AB-2005, “Station and Media Access Control, Connectivity Discovery”
- [9] MEF Technical Specification MEF 16, “Ethernet Local Management Interface”, January 2006
- [10] IEEE 802.1ad-2005, “Virtual Bridged Local Area Networks – Amendment 4: Provider Bridges”
- [11] IEEE 802.1ag-2007, “Virtual Bridged Local Area Networks – Amendment 5: Connectivity Fault Management”
- [12] MEF Technical Specification MEF 4, “Metro Ethernet Network Architecture Framework - Part 1: Generic Framework”, May 2004
- [13] ITU-T Recommendation G.8011.1/Y.1307.1, “Ethernet Private Line”
- [14] ITU-T Recommendation G.8011.2/Y.1307.2, “Ethernet Virtual Private Line Service”
- [15] ITU-T Recommendation Y.1731, “OAM functions and mechanisms for Ethernet based networks”
- [16] MEF Technical Specification MEF 17, “Service OAM Requirements & Framework – Phase 1”, April 2007
- [17] IEEE 802.1ak-2007, “Virtual Bridged Local Area Networks, Amendment 07: Multiple Registration Protocol”

## 11. Appendix A: MEF and IEEE 802.1 Terminology (Informative)

There are many cases where some protocols need to be tunneled. One example is when a Subscriber has bridge CEs at various sites that are connected via an Ethernet service, with back door connections among the sites. In this case, the service needs to tunnel the Subscriber spanning tree BPDUs so the Subscriber can ensure a loop free topology among his CEs. Other L2CPs may need to be handled differently, e.g., PAUSE frames may need to be discarded.

MEF defines these options in terms of service attributes, i.e., what the Subscriber can expect end-to-end across the network. On the other hand, IEEE 802.1 defines terms local to a bridge function, e.g., a Provider Bridge S-VLAN component must forward (relay) Subscriber spanning tree frames. Since networks can be composed of different types of network elements, some of which may be bridges and some not, there is a need for MEF terms to characterize the service attributes, while understanding the Provider Bridge terms.

Some of the requirements in Section 8 of this document assume alignment with the IEEE 802.1ad, Provider Bridges [10] specification. This subsection is intended to provide a mapping of MEF L2CP terms to IEEE 802.1 bridge terminology with respect to Layer 2 Control Protocol (L2CP) processing options for the various L2CPs identified in this specification.

As defined in [2], MEF allows for three L2CP processing options for each L2CP. These are briefly described below:

- ‘Peer’ means that the MEN will participate in the protocol.
- ‘Tunnel’ means that an ingress L2CP frame at a given UNI gets delivered unchanged to each of the destination UNIs. The requirement is that all UNIs in the EVC must tunnel the same protocols. In 802.1 terms, the L2CP is forwarded through the bridge relay.
- ‘Discard’ means that the MEN will ignore the L2CP frame, i.e., it will not participate in the protocol and it will not forward the frame.

Table 37 summarizes the correlation of terms:

MEF Term	IEEE 802.1 Term
Peer	Participate
Tunnel	Forward (relay)
Discard	Not forward, Not participate

**Table 37: MEF and IEEE 802.1 terms for L2CP Processing Options**

## 12. Appendix B: Practical Examples of Ethernet Services (Informative)

This appendix provides service instance examples of the E-Line, E-LAN, and E-Tree Service Types defined in Section 6. These service examples are assumed to be offered by a hypothetical metro Service Provider, ACME, offering a portfolio of turbo-charged Ethernet services.

Table 38 is used for defining an example of the EVC performance attributes, parameters, and values associated with each of the Classes of Service offered by ACME. For simplicity, it is assumed that the values for the performance parameters shown below apply to all Ethernet services, i.e., E-Line, E-LAN, and E-Tree services. In actuality, Service Providers may offer different CoS and associated performance attribute objectives for the three service types. Also, since the objective values can be controversial and have wide variance among Service Providers, actual numbers are not used for the objective values.

Table 38 is used as a reference for Ethernet Services in each of the examples in the following subsections.

<b>Example of Turbo-Charged Ethernet Services offered by the ACME Service Provider</b>				
<b>EVC Performance Attribute</b>	<b>Parameters</b>	<b>Class of Service Offering</b>		
		<b>Krypton</b>	<b>Argon</b>	<b>Neon</b>
CoS ID (Priority Code Point value)	N/A	PCP=5	PCP=4	PCP=0
Frame Delay (FD)	Subset of ordered UNI pairs (S)	All	All	All
	FD Objective	X ms	Y ms (Y>X)	Z ms (Z>Y)
	Percentile (P)	95%	95%	95%
	Time interval (T)	1 hour	1 hour	1 hour
Frame Delay Variation (FDV)	Subset of ordered UNI pairs (S)	All	All	All
	FDV objective	Q ms	N/S	N/S
	Percentile (P)	95%	N/S	N/S
	Time interval (T)	1 hour	N/S	N/S
	Pair interval ( $\Delta t$ )	100 ms	N/S	N/S
Frame Loss Ratio (FLR)	Subset of ordered UNI pairs (S)	All	All	All
	FLR Objective	A%	B% (B>A)	C% (C>B)
	Time interval (T)	1 hour	1 hour	1 hour
Availability	Subset of UNI pairs (S)	All	All	All
	Availability Objective	$\alpha\%$	$\beta\%$ ( $\beta < \alpha$ )	$\gamma\%$ ( $\gamma < \beta$ )
	Time interval (T)	1 month	1 month	1 month
	Number of consecutive small time intervals (n)	1	1	1
	Small time interval ( $\Delta t$ )	2 minutes	2 minutes	2 minutes
	Unavailability frame loss ratio threshold ( $C_u$ )	50%	75%	100%
	Availability frame loss ratio threshold ( $C_a$ )	0%	25%	50%

**Table 38: EVC Performance Attributes and Parameters per CoS Offering**



In Table 38, the value ‘All’ in the ‘Subset of ordered UNI pairs’ entries, means that all possible ordered pairs of UNIs are included in the offering. The reader is directed to [2] for precise definitions of the CoS attributes and parameters.

Table 39 is used for defining the Layer 2 Control Protocol (L2CP) processing options used by a given Service Provider at a UNI. Different L2CP processing options are used for All-to-One Bundled (port-based services) and Service Multiplexed (VLAN-based services) UNIs. This table is used as a reference for each of the examples in the following subsections. It is assumed that the L2CP protocol and MAC address pair specified in Section 8 of this document is the one used for the indicated protocol.

Layer 2 Control Protocol	Port-based Services		VLAN-based Services
	PB1	PB2	
Spanning Tree Protocols	Tunnel	Tunnel	Discard
PAUSE (802.3x)	Discard	Discard	Discard
LACP/LAMP	Discard (unprotected UNI) Peer (protected UNI)	Tunnel	Discard (unprotected UNI) Peer (protected UNI)
Link OAM	Peer	Tunnel	Peer
Port Authentication (802.1x)	Discard	Tunnel	Discard
E-LMI	Peer	Tunnel	Peer
LLDP	Discard	Tunnel	Discard
GARP/MRP	Tunnel	Tunnel	Discard

**Table 39: L2CP Attribute and Parameters per Service Offering**

**12.1 EXAMPLE: A TRANSPORT-ORIENTED ETHERNET PRIVATE LINE (EPL) SERVICE FOR PRIVATE DATA NETWORKING APPLICATIONS.**

A popular application of transport-oriented (or circuit-like) EPL services is to provide an interconnect service between routing or switching equipment in an enterprise’s private data network. This need may arise when a subscriber wishes to manage its own networking infrastructure and desires a transport service that emulates as close as possible a dedicated circuit. In such scenario, the MEN provides point-to-point interconnect services between 2 designated UNI-N ports at a given POP(s) and allocates transport resources according to the desired circuit rate (typically the UNI port speed).

Since the subscriber wishes to manage its own packet network infrastructure the EPL service must be configured to be highly transparent to the subscriber traffic. Transparency here implies expectations for minimal interaction with client’s data frames, including associated management and control traffic between the subscriber’s routers and switches. It also implies expectations for minimal flow variability to be introduced into the client’s data stream (i.e., circuit-like forwarding).

The service architecture is illustrated in Figure 12 below. The red dots represent the MEN UNIs and the red dash represents the EVC instance that realizes the EPL service.

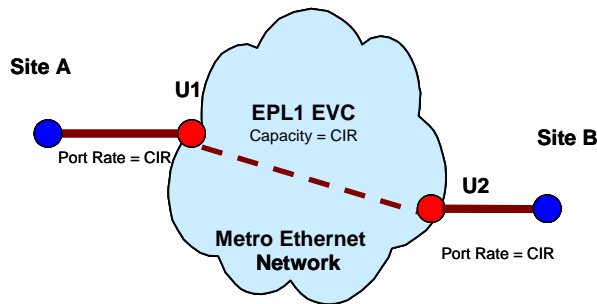

**Figure 12: Example of Transport-Oriented Private Data Network Interconnect Using the EPL Service**

The traffic pattern is that the subscriber data, management and control frames are sent from UNI to UNI over a symmetric path. Routing/switching equipment on the subscriber side may send their own L2 control messages without interference from the MEN.

In the case where the Service Provider wishes to have redundancy, a back-up EVC may be used with some redundancy protocol to ensure that only one of the EVCs is active at any time. Alternatively, two similar EPL services may be instantiated between Sites A and B and allow for client-side protection (e.g., via LAG directly between switches on the subscriber site). For this case the suggested UNI attributes are depicted in Table 40.

UNI Service Attribute	UNI 1	UNI 2
UNI Identifier	U1	U2
Physical Medium	1000BASE-SX	1000BASE-LX
Speed	1 Gbps	1 Gbps
Mode	FDX	FDX
MAC Layer	IEEE 802.3-2005	IEEE 802.3-2005
UNI MTU Size	1522	1522
Service Multiplexing	No	No
Bundling	No	No
All to One Bundling	Yes	Yes
CE-VLAN ID for untagged and priority tagged Service Frames	NA	NA
Maximum number of EVCs	1	1
Ingress Bandwidth Profile Per UNI	N/A	N/A
Egress Bandwidth Profile Per UNI	N/A	N/A
L2CP Processing	Table 39, PB2	Table 39, PB2

**Table 40: UNI attributes for the Private Data Networking example using EPL Service**

Table 41 provides the EVC per UNI attributes for the Private Data Networking example.

UNI Service Attribute	UNIs 1	UNI 2
UNI EVC ID	U1_EPL1	U2_EPL1
CE-VLAN ID / EVC Map	All Service Frames at the UNI map to a single EPL EVC	All Service Frames at the UNI map to a single EPL EVC
Ingress Bandwidth Profile Per EVC	N/A	N/A
Ingress Bandwidth Profile Per CoS ID	CoS ID = EVC CIR=1Gbps, CBS=1522, EIR=0, EBS=0, color blind, CF=0	CoS ID = EVC CIR=1Gbps, CBS=1522, EIR=0, EBS=0, color blind, CF=0
Egress Bandwidth Profile Per EVC	N/A	N/A
Egress Bandwidth Profile Per CoS ID	N/A	N/A

**Table 41: EVC per UNI attributes for the private data networking example using EPL Service**

Table 42 provides the EVC attributes for the private data networking example.

EVC Service Attribute	EVC_1
EVC Type	Point-to-Point
EVC ID	EPL1
UNI List	{U1, U2}
Maximum Number of UNIs	2
EVC MTU size	1522
CE-VLAN ID Preservation	Yes
CE-VLAN CoS Preservation	Yes
Unicast Service Frame Delivery	Deliver Unconditionally
Multicast Service Frame Delivery	Deliver Unconditionally
Broadcast Service Frame Delivery	Deliver Unconditionally
Layer 2 Control Protocols Processing	Table 39, PB2
Service Performance	Krypton CoS

**Table 42: EVC service attributes for the private data networking example using the EPL Service**

## 12.2 EXAMPLE OF A PACKET-ORIENTED ETHERNET PRIVATE LINE SERVICE FOR PUBLIC DATA NETWORKING APPLICATIONS

A popular application of packet-oriented (or statistical) EPL services is to provide an interconnect service between routing or switching equipment in an enterprise via a public data networking service. This need arises when a subscriber wishes to interconnect multiple sites but does not wish to manage the intermediate datacom facilities. In such scenario, the MEN provides point-to-point interconnect services between 2 designated UNI-N ports at a given POP(s) and allocates transport resources according to the anticipate traffic volume between the sites (typically less than the UNI port speed).

Since the subscriber does not wish to manage its own packet network infrastructure there is little expectation for data flow symmetry or transparency. The service interfaces at the UNIs may operate at different rates, bandwidth allocation traffic at each UNI may also be asymmetric. Non-essential traffic may be forwarded according to resource availability (i.e., statistical multiplexing).

The service architecture is illustrated in Figure 13 below. The red dots represent the MEN UNIs and the red dash represents the EVC instance that realizes the EPL service.

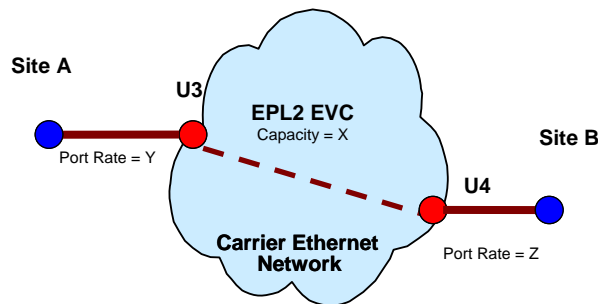

**Figure 13: Example of Transport-Oriented Public Data Network Interconnect Using the EPL Service.**

The traffic pattern is that the subscriber data, management and control frames are sent from UNI to UNI over a potentially asymmetric path. Different levels of performance applicable depending on the traffic type (potentially indicated via PCP marking). Non-essential L2 control messages are typically discarded.

In the case where the Service Provider wishes to have redundancy, a back-up EVC may be used with some redundancy protocol to ensure that only one of the EVCs is active at any time. The UNI link may also be protected via link aggregation. For this case the suggested UNI attributes are depicted in Table 43.

UNI Service Attribute	UNI 3	UNI 4
UNI Identifier	U3	U4
Physical Medium	1000BASE-SX	100BASE-TX
Speed	1 Gbps	100 Mbps
Mode	FDX	FDX
MAC Layer	IEEE 802.3-2005	IEEE 802.3-2005
UNI MTU Size	1522	1522
Service Multiplexing	No	No
Bundling	No	No
All to One Bundling	Yes	Yes
CE-VLAN ID for untagged and priority tagged Service Frames	NA	NA
Maximum number of EVCs	1	1
Ingress Bandwidth Profile UNI	N/A	N/A
Egress Bandwidth Profile Per UNI	N/A	N/A
L2CP Processing	Table 39, PB1	Table 39, PB1

**Table 43: UNI attributes for the Private Data Networking example using EPL Service**

Table 44 provides the EVC per UNI attributes for the Private Data Networking example.

UNI Service Attribute	UNI 3	UNI 4
UNI EVC ID	U3_EPL2	U4_EPL2
CE-VLAN ID / EVC Map	All Service Frames at the UNI map to a single EPL EVC	All Service Frames at the UNI map to a single EPL EVC
Ingress Bandwidth Profile Per EVC	N/A	N/A
Ingress Bandwidth Profile Per CoS ID	PCP = 5: CIR=20Mbps, CBS=10k, EIR=0, EBS=0, color blind, CF=0 PCP = 0: CIR=10Mbps, CBS=50k, EIR=0, EBS=0, color blind, CF=0	PCP = 5: CIR=30 Mbps, CBS=10k, EIR=0, EBS=0, color blind, CF=0 PCP = 0: CIR=5 Mbps, CBS=10k, EIR=10 Mbps, EBS=50K, color blind, CF=0
Egress Bandwidth Profile Per EVC	N/A	N/A
Egress Bandwidth Profile Per CoS ID	N/A	N/A

**Table 44: EVC per UNI attributes for the public data networking example using EPL Service**

Table 45 provides the EVC attributes for the public data networking example.

<b>EVC Service Attribute</b>	<b>EVC_1</b>
EVC Type	Point-to-Point
EVC ID	EPL2
UNI List	{U3, U4}
Maximum Number of UNIs	2
EVC MTU size	1522
CE-VLAN ID Preservation	Yes
CE-VLAN CoS Preservation	Yes
Unicast Service Frame Delivery	Deliver Unconditionally
Multicast Service Frame Delivery	Deliver Unconditionally
Broadcast Service Frame Delivery	Deliver Unconditionally
Layer 2 Control Protocols Processing	Table 39, PB1
Service Performance	CoS ID=5: Krypton CoS CoS ID=0: Neon CoS

**Table 45: EVC service attributes for the public data networking example using the EPL Service**

### 12.3 EXAMPLE: ETHERNET PRIVATE TREE (EP-TREE) SERVICE FOR VIDEO BROADCAST

One example of using the EP-Tree service is for a video broadcast application. In this scenario, a video head-end is located in a POP (this UNI is designated as a Root) providing a service to multiple subscribers (each connected to a UNI designated as a Leaf). The service might offer multiple broadcast channels.

In the case where all channels are to be delivered to each of the subscribers, this service is uni-directional (no traffic from Leaf to Root). In this mode, scalability is enhanced compared to E-Line services.

However, if each subscriber needs just a subset of the available channels, then each location (connected to a Leaf UNI) may receive a specific channel. The signaling of the desired channel could be done via a standard multicast protocol (IGMPv3 for example).

We denote these cases as A and B, respectively. The service architecture is illustrated in Figure 14 below. The blue dots represent Root UNIs and the red dots represent Leaf UNIs for this EVC.

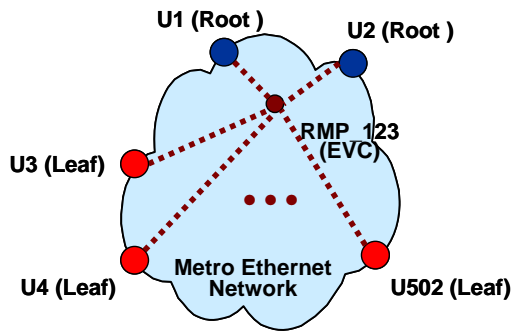

**Figure 14: Example of Video Broadcast Delivery Using the EP-Tree Service**

The traffic pattern is that the video content is sent from the video head-end towards the receiving subscribers, while each such subscriber may send control messages to the video head-end.

In the case where the Service Provider wishes to have redundancy, two Root UNIs may be used with some redundancy protocol ensuring that only one of them transmits data into the EVC.

For this case the suggested UNI attributes are depicted in Table 46.

UNI Service Attribute	Root UNIs	Leaf UNIs
UNI Identifier	U1 (primary), U2 (back-up)	U3 → U502
Physical Medium	1000BASE-LX	100BASE-TX
Speed	1 Gbps	100 Mbps
Mode	FDX	FDX
MAC Layer	IEEE 802.3-2005	IEEE 802.3-2005
UNI MTU Size	1522	1522
Service Multiplexing	No	No
Bundling	No	No
All to One Bundling	Yes	Yes
CE-VLAN ID for untagged and priority tagged Service Frames	1 (but not significant)	1 (but not significant)
Maximum number of EVCs	1	1
Ingress Bandwidth Profile Per UNI	N/A <sup>7</sup>	CIR=1 Mbps, CBS=10KB, EIR=0, EBS=0, color blind, CF=0 <sup>8</sup>
Egress Bandwidth Profile Per UNI	N/A	N/A
L2CP Processing	Table 39, PB1	Table 39, PB1

**Table 46: UNI attributes for the video broadcast example using EP-Tree Service**

<sup>7</sup> Video source may be considered trusted and constant bit rate.

<sup>8</sup> Minimal traffic from Leaf to Root.

Table 47 provides the EVC per UNI attributes for the video broadcast example.

UNI Service Attribute	UNIs 1 & 2	UNIs 3 → 502
UNI EVC ID	U1_RMP123, U2_RMP123	U1_RMP123, ... U502_RMP123
CE-VLAN ID / EVC Map	All Service Frames at the UNI map to a single Rooted-Multipoint EVC	All Service Frames at the UNI map to a single Rooted-Multipoint EVC
Ingress Bandwidth Profile Per EVC	N/A	N/A
Ingress Bandwidth Profile Per CoS ID	N/A	N/A
Egress Bandwidth Profile Per EVC	N/A	N/A
Egress Bandwidth Profile Per CoS ID	N/A	N/A

**Table 47: EVC per UNI attributes for the video broadcast example using EP-Tree Service**

Table 48 provides the EVC attributes for the video broadcast example.

EVC Service Attribute	EVC_1
EVC Type	Rooted-Multipoint
EVC ID	RMP_123
UNI List	{U1, Root/U2, Root/U3, Leaf/U4, Leaf/.../U502, Leaf}
Maximum Number of UNIs	502 <sup>9</sup>
EVC MTU size	1522
CE-VLAN ID Preservation	Yes
CE-VLAN CoS Preservation	Yes
Unicast Service Frame Delivery	Deliver Unconditionally
Multicast Service Frame Delivery	Deliver Conditionally: only deliver content subscribed to on a given Leaf UNI
Broadcast Service Frame Delivery	Deliver Unconditionally
Layer 2 Control Protocols Processing	Table 39, PB1
EVC Performance (for all ordered UNI pairs where at least one UNI in each pair is of type Root).	Krypton CoS

**Table 48: EVC service attributes for the video broadcast example using EP-Tree Service**

## 12.4 EXAMPLE: DISTANCE LEARNING (EVP-TREE) AND BUSINESS DATA (EVP-LAN)

In this example, we build a more complex scenario for an E-Tree type of service and overlay it with an E-LAN type of service. All Subscriber locations are connected with two EVCs: EVP-LAN service is used for a business data application, and EVP-tree service is used for a distance learning application, which is based on IP video.

<sup>9</sup> 502 allows for up to 500 video receivers (Leaf UNIs) in this service instance



Since the same UNIs are used for both services, service multiplexing is required at each UNI, and separate bandwidth profiles are needed to ensure that the services do not adversely affect each other. For the E-LAN service, bundling is required to ensure CE-VLAN ID transparency in the range indicated in Table 50. For the E-Tree service, bundling is not required. Figure 15 below shows this example. The blue dots represent Root UNIs and the red dots represent Leaf UNIs for the two EVCs. Each EVC has a single Class of Service, Neon for MP\_111 and Krypton for RMP\_333.

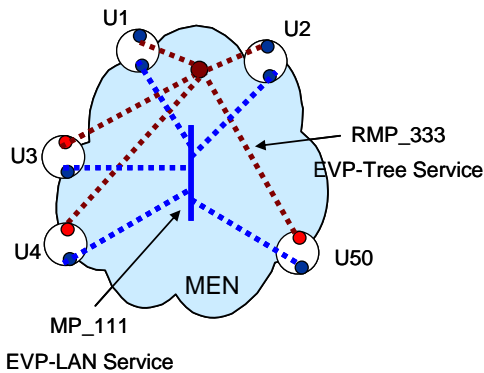

**Figure 15: Example of Distance Learning and Business Data Using EVP-LAN and EVP-Tree Services**

The suggested UNI attributes are shown in Table 49 below.

UNI Service Attribute	UNIs 1 & 2	UNIs 3 → 50
UNI Identifier	U1, U2	U3 → U50
Physical Medium	1000BASE-LX	100BASE-TX
Speed	1 Gbps	100 Mbps
Mode	FDX	FDX
MAC Layer	IEEE 802.3-2005	IEEE 802.3-2005
UNI MTU Size	1522	1522
Service Multiplexing	Yes	Yes
Bundling	Yes	Yes
All to One Bundling	No	No
CE-VLAN ID for untagged and priority tagged Service Frames	1	1
Maximum number of EVCs	10	5
Ingress Bandwidth Profile Per UNI	N/A	N/A
Egress Bandwidth Profile Per UNI	N/A	N/A
L2CP Processing	Table 39, VLAN-based	Table 39, VLAN-based

**Table 49: UNI attributes for the distance learning, business data example**

The suggested EVC per UNI attributes are shown in Table 50 below. For table simplicity, only UNI 1 and UNI 50 are shown. It is expected that attributes for UNI 1 and 2 are similar and that UNIs 3-50 are similar to each other.

EVC per UNI Service Attribute		UNIs 1 & 2		UNIs 3-50	
		EVC_1	EVC_2	EVC_1	EVC_2
UNI EVC ID		U1_MP111	U1_RMP333	U50_MP111	U50_RMP333
CE-VLAN ID / EVC Map		11-3999	4000	11-3999	4000
Ingress Bandwidth Profile Per CoS ID of 'EVC' for Neon CoS on EVC_1	CIR (Mbps)	20	N/A	20	N/A
	CBS (KB)	50	N/A	50	N/A
	EIR (Mbps)	20	N/A	20	N/A
	EBS (KB)	50	N/A	50	N/A
	CM	Color Blind	N/A	Color Blind	N/A
	CF	0	N/A	0	N/A
Ingress Bandwidth Profile Per CoS ID of 'EVC' for Krypton CoS on EVC_2	CIR (Mbps)	N/A	10	N/A	10
	CBS (KB)	N/A	20	N/A	20
	EIR (Mbps)	N/A	0	N/A	0
	EBS (KB)	N/A	0	N/A	0
	CM	N/A	Color Blind	N/A	Color Blind
	CF	N/A	0	N/A	0
Egress Bandwidth Profile Per CoS ID of 'EVC' for Neon CoS	CIR (Mbps)	20	N/A	20	N/A
	CBS (KB)	70	N/A	70	N/A
	EIR (Mbps)	20	N/A	20	N/A
	EBS (KB)	70	N/A	70	N/A
	CM	Color Blind	N/A	Color Blind	N/A
	CF	1	N/A	1	N/A
Egress Bandwidth Profile Per CoS ID of 'EVC' for Krypton CoS	CIR (Mbps)	N/A	10	N/A	1
	CBS (KB)	N/A	20	N/A	15
	EIR (Mbps)	N/A	0	N/A	0
	EBS (KB)	N/A	0	N/A	0
	CM	N/A	Color Blind	N/A	Color Blind
	CF	N/A	0	N/A	0

**Table 50: EVC per UNI attributes for the distance learning, business data example**

The suggested EVC service attributes and parameter values are shown in Table 51 below for each of the EVCs in this example.

EVC Service Attribute	EVC-1	EVC_2
EVC Type	Multipoint-to-Multipoint	Rooted-Multipoint
EVC ID	MP_111	RMP_333
UNI List	{U1, Root/U2, Root/.../U50, Root}	{U1, Root/U2, Root/U3, Leaf/.../U50, Leaf}
Maximum Number of UNIs	100	50
EVC MTU size	1522	1522
CE-VLAN ID Preservation	Yes	No
CE-VLAN CoS Preservation	Yes	No
Unicast Service Frame Delivery	Deliver Conditionally: for known D-MACs only to destination UNI; for unknown D-MACs, deliver unconditionally to all destination UNIs	Deliver Unconditionally
Multicast Service Frame Delivery	Deliver Unconditionally	Deliver Conditionally: only deliver content subscribed to on a given Leaf UNI
Broadcast Service Frame Delivery	Deliver Unconditionally	Deliver Unconditionally
Layer 2 Control Protocols Processing	Table 39, VLAN-based	Table 39, VLAN-based
EVC Performance	Neon CoS (for all ordered UNI pairs)	Krypton CoS (for all ordered UNI pairs where at least one UNI in each pair is of type Root)

**Table 51: EVC attributes for the distance learning, business data example**