



# TOSCA Simple Profile in YAML Version 1.2

## Committee Specification 01

19 July 2018

### Specification URIs

#### This version:

<http://docs.oasis-open.org/tosca/TOSCA-Simple-Profile-YAML/v1.2/cs01/TOSCA-Simple-Profile-YAML-v1.2-cs01.pdf> (Authoritative)  
<http://docs.oasis-open.org/tosca/TOSCA-Simple-Profile-YAML/v1.2/cs01/TOSCA-Simple-Profile-YAML-v1.2-cs01.html>  
<http://docs.oasis-open.org/tosca/TOSCA-Simple-Profile-YAML/v1.2/cs01/TOSCA-Simple-Profile-YAML-v1.2-cs01.docx>

#### Previous version:

<http://docs.oasis-open.org/tosca/TOSCA-Simple-Profile-YAML/v1.2/csd01/TOSCA-Simple-Profile-YAML-v1.2-csd01.pdf> (Authoritative)  
<http://docs.oasis-open.org/tosca/TOSCA-Simple-Profile-YAML/v1.2/csd01/TOSCA-Simple-Profile-YAML-v1.2-csd01.html>  
<http://docs.oasis-open.org/tosca/TOSCA-Simple-Profile-YAML/v1.2/csd01/TOSCA-Simple-Profile-YAML-v1.2-csd01.docx>

#### Latest version:

<http://docs.oasis-open.org/tosca/TOSCA-Simple-Profile-YAML/v1.2/TOSCA-Simple-Profile-YAML-v1.2.pdf> (Authoritative)  
<http://docs.oasis-open.org/tosca/TOSCA-Simple-Profile-YAML/v1.2/TOSCA-Simple-Profile-YAML-v1.2.html>  
<http://docs.oasis-open.org/tosca/TOSCA-Simple-Profile-YAML/v1.2/TOSCA-Simple-Profile-YAML-v1.2.docx>

#### Technical Committee:

OASIS Topology and Orchestration Specification for Cloud Applications (TOSCA) TC

#### Chairs:

Paul Lipton ([paul.lipton@ca.com](mailto:paul.lipton@ca.com)), CA Technologies  
Simon Moser ([smoser@de.ibm.com](mailto:smoser@de.ibm.com)), IBM

#### Editors:

Matt Rutkowski ([mrutkows@us.ibm.com](mailto:mrutkows@us.ibm.com)), IBM  
Luc Boutier ([luc.boutier@fastconnect.fr](mailto:luc.boutier@fastconnect.fr)), FastConnect  
Chris Lauwers ([lauwers@ubicity.com](mailto:lauwers@ubicity.com)), Individual Member

#### Related work:

This specification replaces or supersedes:

- *TOSCA Simple Profile in YAML Version 1.1*. Edited by Matt Rutkowski and Luc Boutier. Latest version: <http://docs.oasis-open.org/tosca/TOSCA-Simple-Profile-YAML/v1.1/TOSCA-Simple-Profile-YAML-v1.1.html>.
- *TOSCA Simple Profile in YAML Version 1.0*. Edited by Derek Palma, Matt Rutkowski, and Thomas Spatzier. Latest version: <http://docs.oasis-open.org/tosca/TOSCA-Simple-Profile-YAML/v1.0/TOSCA-Simple-Profile-YAML-v1.0.html>.

This specification is related to:

- *Topology and Orchestration Specification for Cloud Applications Version 1.0*. Edited by Derek Palma and Thomas Spatzier. 25 November 2013. OASIS Standard. <http://docs.oasis-open.org/tosca/TOSCA/v1.0/os/TOSCA-v1.0-os.html>.

**Declared XML namespace:**

- <http://docs.oasis-open.org/tosca/ns/simple/yaml/1.2>

**Abstract:**

This document defines a simplified profile of the TOSCA version 1.0 specification in a YAML rendering which is intended to simplify the authoring of TOSCA service templates. This profile defines a less verbose and more human-readable YAML rendering, reduced level of indirection between different modeling artifacts as well as the assumption of a base type system.

**Status:**

This document was last revised or approved by the OASIS Topology and Orchestration Specification for Cloud Applications (TOSCA) TC on the above date. The level of approval is also listed above. Check the “Latest version” location noted above for possible later revisions of this document. Any other numbered Versions and other technical work produced by the Technical Committee (TC) are listed at [https://www.oasis-open.org/committees/tc\\_home.php?wg\\_abbrev=tosca#technical](https://www.oasis-open.org/committees/tc_home.php?wg_abbrev=tosca#technical).

TC members should send comments on this specification to the TC’s email list. Others should send comments to the TC’s public comment list, after subscribing to it by following the instructions at the “Send A Comment” button on the TC’s web page at <https://www.oasis-open.org/committees/tosca/>.

This specification is provided under the [RF on Limited Terms](#) Mode of the [OASIS IPR Policy](#), the mode chosen when the Technical Committee was established. For information on whether any patents have been disclosed that may be essential to implementing this specification, and any offers of patent licensing terms, please refer to the Intellectual Property Rights section of the TC’s web page (<https://www.oasis-open.org/committees/tosca/ipr.php>).

Note that any machine-readable content ([Computer Language Definitions](#)) declared Normative for this Work Product is provided in separate plain text files. In the event of a discrepancy between any such plain text file and display content in the Work Product’s prose narrative document(s), the content in the separate plain text file prevails.

**Citation format:**

When referencing this specification the following citation format should be used:

**[TOSCA-Simple-Profile-YAML-v1.2]**

*TOSCA Simple Profile in YAML Version 1.2*. Edited by Matt Rutkowski, Luc Boutier, and Chris Lauwers. 19 July 2018. OASIS Committee Specification 01. <http://docs.oasis-open.org/tosca/TOSCA-Simple-Profile-YAML/v1.2/cs01/TOSCA-Simple-Profile-YAML-v1.2-cs01.html>. Latest version: <http://docs.oasis-open.org/tosca/TOSCA-Simple-Profile-YAML/v1.2/TOSCA-Simple-Profile-YAML-v1.2.html>.

---

## Notices

Copyright © OASIS Open 2018. All Rights Reserved.

All capitalized terms in the following text have the meanings assigned to them in the OASIS Intellectual Property Rights Policy (the "OASIS IPR Policy"). The full [Policy](#) may be found at the OASIS website.

This document and translations of it may be copied and furnished to others, and derivative works that comment on or otherwise explain it or assist in its implementation may be prepared, copied, published, and distributed, in whole or in part, without restriction of any kind, provided that the above copyright notice and this section are included on all such copies and derivative works. However, this document itself may not be modified in any way, including by removing the copyright notice or references to OASIS, except as needed for the purpose of developing any document or deliverable produced by an OASIS Technical Committee (in which case the rules applicable to copyrights, as set forth in the OASIS IPR Policy, must be followed) or as required to translate it into languages other than English.

The limited permissions granted above are perpetual and will not be revoked by OASIS or its successors or assigns.

This document and the information contained herein is provided on an "AS IS" basis and OASIS DISCLAIMS ALL WARRANTIES, EXPRESS OR IMPLIED, INCLUDING BUT NOT LIMITED TO ANY WARRANTY THAT THE USE OF THE INFORMATION HEREIN WILL NOT INFRINGE ANY OWNERSHIP RIGHTS OR ANY IMPLIED WARRANTIES OF MERCHANTABILITY OR FITNESS FOR A PARTICULAR PURPOSE.

OASIS requests that any OASIS Party or any other party that believes it has patent claims that would necessarily be infringed by implementations of this OASIS Committee Specification or OASIS Standard, to notify OASIS TC Administrator and provide an indication of its willingness to grant patent licenses to such patent claims in a manner consistent with the IPR Mode of the OASIS Technical Committee that produced this specification.

OASIS invites any party to contact the OASIS TC Administrator if it is aware of a claim of ownership of any patent claims that would necessarily be infringed by implementations of this specification by a patent holder that is not willing to provide a license to such patent claims in a manner consistent with the IPR Mode of the OASIS Technical Committee that produced this specification. OASIS may include such claims on its website, but disclaims any obligation to do so.

OASIS takes no position regarding the validity or scope of any intellectual property or other rights that might be claimed to pertain to the implementation or use of the technology described in this document or the extent to which any license under such rights might or might not be available; neither does it represent that it has made any effort to identify any such rights. Information on OASIS' procedures with respect to rights in any document or deliverable produced by an OASIS Technical Committee can be found on the OASIS website. Copies of claims of rights made available for publication and any assurances of licenses to be made available, or the result of an attempt made to obtain a general license or permission for the use of such proprietary rights by implementers or users of this OASIS Committee Specification or OASIS Standard, can be obtained from the OASIS TC Administrator. OASIS makes no representation that any information or list of intellectual property rights will at any time be complete, or that any claims in such list are, in fact, Essential Claims.

The name "OASIS" is a trademark of [OASIS](#), the owner and developer of this specification, and should be used only to refer to the organization and its official outputs. OASIS welcomes reference to, and implementation and use of, specifications, while reserving the right to enforce its marks against misleading uses. Please see <https://www.oasis-open.org/policies-guidelines/trademark> for above guidance.

---

# Table of Contents

Table of Examples .....	7
Table of Figures .....	7
1 Introduction .....	8
1.0 IPR Policy .....	8
1.1 Objective .....	8
1.2 Summary of key TOSCA concepts .....	8
1.3 Implementations .....	9
1.4 Terminology .....	9
1.5 Notational Conventions .....	9
1.6 Normative References .....	9
1.7 Non-Normative References .....	10
1.8 Glossary .....	10
2 TOSCA by example .....	12
2.1 A “hello world” template for TOSCA Simple Profile in YAML .....	12
2.2 TOSCA template for a simple software installation .....	14
2.3 Overriding behavior of predefined node types .....	16
2.4 TOSCA template for database content deployment .....	17
2.5 TOSCA template for a two-tier application .....	19
2.6 Using a custom script to establish a relationship in a template .....	22
2.7 Using custom relationship types in a TOSCA template .....	23
2.8 Defining generic dependencies between nodes in a template .....	25
2.9 Describing abstract requirements for nodes and capabilities in a TOSCA template .....	26
2.10 Using node template substitution for model composition .....	30
2.11 Using node template substitution for chaining subsystems .....	34
2.12 Grouping node templates .....	40
2.13 Using YAML Macros to simplify templates .....	43
2.14 Passing information as inputs to Nodes and Relationships .....	44
2.15 Topology Template Model versus Instance Model .....	45
2.16 Using attributes implicitly reflected from properties .....	46
3 TOSCA Simple Profile definitions in YAML .....	48
3.1 TOSCA Namespace URI and alias .....	48
3.2 Using Namespaces .....	49
3.3 Parameter and property types .....	52
3.4 Normative values .....	61
3.5 TOSCA Metamodel .....	63
3.6 Reusable modeling definitions .....	63
3.7 Type-specific definitions .....	96
3.8 Template-specific definitions .....	114
3.9 Topology Template definition .....	132
3.10 Service Template definition .....	140
4 TOSCA functions .....	153
4.1 Reserved Function Keywords .....	153
4.2 Environment Variable Conventions .....	153

4.3	Intrinsic functions .....	156
4.4	Property functions .....	158
4.5	Attribute functions .....	160
4.6	Operation functions .....	162
4.7	Navigation functions .....	162
4.8	Artifact functions .....	163
4.9	Context-based Entity names (global) .....	165
5	TOSCA normative type definitions .....	166
5.1	Assumptions .....	166
5.2	TOSCA normative type names .....	166
5.3	Data Types .....	166
5.4	Artifact Types .....	178
5.5	Capabilities Types .....	181
5.6	Requirement Types .....	192
5.7	Relationship Types .....	192
5.8	Interface Types .....	195
5.9	Node Types .....	201
5.10	Group Types .....	213
5.11	Policy Types .....	214
6	TOSCA Cloud Service Archive (CSAR) format .....	216
6.1	Overall Structure of a CSAR .....	216
6.2	TOSCA Meta File .....	216
6.3	Archive without TOSCA-Metadata .....	217
7	TOSCA workflows .....	218
7.1	Normative workflows .....	218
7.2	Declarative workflows .....	218
7.3	Imperative workflows .....	222
7.4	Making declarative more flexible and imperative more generic .....	237
8	TOSCA networking .....	240
8.1	Networking and Service Template Portability .....	240
8.2	Connectivity semantics .....	240
8.3	Expressing connectivity semantics .....	241
8.4	Network provisioning .....	243
8.5	Network Types .....	247
8.6	Network modeling approaches .....	253
9	Non-normative type definitions .....	258
9.1	Artifact Types .....	258
9.2	Capability Types .....	258
9.3	Node Types .....	260
10	Component Modeling Use Cases .....	264
11	Application Modeling Use Cases .....	271
11.1	Use cases .....	271
12	TOSCA Policies .....	319
12.1	A declarative approach .....	319
12.2	Consideration of Event, Condition and Action .....	319

12.3	Types of policies .....	319
12.4	Policy relationship considerations .....	320
12.5	Use Cases .....	321
13	Artifact Processing and creating portable Service Templates .....	324
13.1	Artifacts Processing .....	324
13.2	Dynamic Artifacts .....	328
13.3	Discussion of Examples.....	328
13.4	Artifact Types and Metadata.....	335
14	Abstract nodes and target node filters matching .....	336
14.1	Reminder on types.....	336
14.2	Orchestrator catalogs .....	336
14.3	Abstract node template matching .....	337
14.4	Target node filter matching.....	342
14.5	Post matching properties .....	347
15	Conformance .....	348
15.1	Conformance Targets .....	348
15.2	Conformance Clause 1: TOSCA YAML service template .....	348
15.3	Conformance Clause 2: TOSCA processor.....	348
15.4	Conformance Clause 3: TOSCA orchestrator .....	348
15.5	Conformance Clause 4: TOSCA generator .....	349
15.6	Conformance Clause 5: TOSCA archive.....	349
Appendix A.	Known Extensions to TOSCA v1.0.....	350
A.1	Model Changes .....	350
A.2	Normative Types .....	350
Appendix B.	Acknowledgments .....	352
Appendix C.	Revision History.....	354

---

## Table of Examples

Example 1 - TOSCA Simple "Hello World" .....	12
Example 2 - Template with input and output parameter sections .....	13
Example 3 - Simple (MySQL) software installation on a TOSCA Compute node .....	15
Example 4 - Node Template overriding its Node Type's "configure" interface .....	16
Example 5 - Template for deploying database content on-top of MySQL DBMS middleware .....	17
Example 6 - Basic two-tier application (web application and database server tiers) .....	20
Example 7 - Providing a custom relationship script to establish a connection .....	22
Example 8 - A web application Node Template requiring a custom database connection type .....	24
Example 9 - Defining a custom relationship type .....	25
Example 10 - Simple dependency relationship between two nodes .....	25
Example 11 - An abstract "host" requirement using a node filter .....	27
Example 12 - An abstract Compute node template with a node filter .....	28
Example 13 - An abstract database requirement using a node filter .....	29
Example 14 - An abstract database node template .....	30
Example 15 - Referencing an abstract database node template .....	32
Example 16 - Using substitution mappings to export a database implementation .....	33
Example 17 - Declaring a transaction subsystem as a chain of substitutable node templates .....	35
Example 18 - Defining a TransactionSubsystem node type .....	37
Example 19 - Implementation of a TransactionSubsystem node type using substitution mappings .....	38
Example 20 - Grouping Node Templates for possible policy application .....	40
Example 21 - Grouping nodes for anti-colocation policy application .....	41
Example 22 - Using YAML anchors in TOSCA templates .....	43
Example 23 - Properties reflected as attributes .....	46

---

## Table of Figures

Figure 1: Using template substitution to implement a database tier .....	31
Figure 2: Substitution mappings .....	33
Figure 3: Chaining of subsystems in a service template .....	35
Figure 4: Defining subsystem details in a service template .....	38
Figure-5: Typical 3-Tier Network .....	244
Figure-6: Generic Service Template .....	253
Figure-7: Service template with network template A .....	254
Figure-8: Service template with network template B .....	254

---

# 1 Introduction

## 2 1.0 IPR Policy

3 This specification is provided under the [RF on Limited Terms](#) Mode of the [OASIS IPR Policy](#), the mode  
4 chosen when the Technical Committee was established. For information on whether any patents have  
5 been disclosed that may be essential to implementing this specification, and any offers of patent licensing  
6 terms, please refer to the Intellectual Property Rights section of the TC's web page ([https://www.oasis-  
open.org/committees/tosca/ipr.php](https://www.oasis-<br/>7 open.org/committees/tosca/ipr.php)).

## 8 1.1 Objective

9 The TOSCA Simple Profile in YAML specifies a rendering of TOSCA which aims to provide a more  
10 accessible syntax as well as a more concise and incremental expressiveness of the TOSCA DSL in order  
11 to minimize the learning curve and speed the adoption of the use of TOSCA to portably describe cloud  
12 applications.

13 This proposal describes a YAML rendering for TOSCA. YAML is a human friendly data serialization  
14 standard (<http://yaml.org/>) with a syntax much easier to read and edit than XML. As there are a number of  
15 DSLs encoded in YAML, a YAML encoding of the TOSCA DSL makes TOSCA more accessible by these  
16 communities.

17 This proposal prescribes an isomorphic rendering in YAML of a subset of the TOSCA v1.0 XML  
18 specification ensuring that TOSCA semantics are preserved and can be transformed from XML to YAML  
19 or from YAML to XML. Additionally, in order to streamline the expression of TOSCA semantics, the YAML  
20 rendering is sought to be more concise and compact through the use of the YAML syntax.

## 21 1.2 Summary of key TOSCA concepts

22 The TOSCA metamodel uses the concept of service templates to describe cloud workloads as a topology  
23 template, which is a graph of node templates modeling the components a workload is made up of and as  
24 relationship templates modeling the relations between those components. TOSCA further provides a type  
25 system of node types to describe the possible building blocks for constructing a service template, as well  
26 as relationship type to describe possible kinds of relations. Both node and relationship types may define  
27 lifecycle operations to implement the behavior an orchestration engine can invoke when instantiating a  
28 service template. For example, a node type for some software product might provide a 'create' operation  
29 to handle the creation of an instance of a component at runtime, or a 'start' or 'stop' operation to handle a  
30 start or stop event triggered by an orchestration engine. Those lifecycle operations are backed by  
31 implementation artifacts such as scripts or Chef recipes that implement the actual behavior.

32 An orchestration engine processing a TOSCA service template uses the mentioned lifecycle operations to  
33 instantiate single components at runtime, and it uses the relationship between components to derive the  
34 order of component instantiation. For example, during the instantiation of a two-tier application that  
35 includes a web application that depends on a database, an orchestration engine would first invoke the  
36 'create' operation on the database component to install and configure the database, and it would then  
37 invoke the 'create' operation of the web application to install and configure the application (which includes  
38 configuration of the database connection).

39 The TOSCA simple profile assumes a number of base types (node types and relationship types) to be  
40 supported by each compliant environment such as a 'Compute' node type, a 'Network' node type or a  
41 generic 'Database' node type. Furthermore, it is envisioned that a large number of additional types for use  
42 in service templates will be defined by a community over time. Therefore, template authors in many cases  
43 will not have to define types themselves but can simply start writing service templates that use existing  
44 types. In addition, the simple profile will provide means for easily customizing and extending existing  
45 types, for example by providing a customized 'create' script for some software.



## 46 1.3 Implementations

47 Different kinds of processors and artifacts qualify as implementations of the TOSCA simple profile. Those  
48 that this specification is explicitly mentioning or referring to fall into the following categories:

- 49 • TOSCA YAML service template (or “service template”): A YAML document artifact containing a  
50 (TOSCA) service template (see sections 3.9 “Service template definition”) that represents a Cloud  
51 application. (see sections 3.8 “Topology template definition”)
- 52 • TOSCA processor (or “processor”): An engine or tool that is capable of parsing and interpreting a  
53 TOSCA service template for a particular purpose. For example, the purpose could be validation,  
54 translation or visual rendering.
- 55 • TOSCA orchestrator (also called orchestration engine): A TOSCA processor that interprets a  
56 TOSCA service template or a TOSCA CSAR in order to instantiate and deploy the described  
57 application in a Cloud.
- 58 • TOSCA generator: A tool that generates a TOSCA service template. An example of generator is  
59 a modeling tool capable of generating or editing a TOSCA service template (often such a tool  
60 would also be a TOSCA processor).
- 61 • TOSCA archive (or TOSCA Cloud Service Archive, or “CSAR”): a package artifact that contains a  
62 TOSCA service template and other artifacts usable by a TOSCA orchestrator to deploy an  
63 application.

64 The above list is not exclusive. The above definitions should be understood as referring to and  
65 implementing the TOSCA simple profile as described in this document (abbreviated here as “TOSCA” for  
66 simplicity).

## 67 1.4 Terminology

68 The TOSCA language introduces a YAML grammar for describing service templates by means of  
69 Topology Templates and towards enablement of interaction with a TOSCA instance model perhaps by  
70 external APIs or plans. The primary currently is on design time aspects, i.e. the description of services to  
71 ensure their exchange between Cloud providers, TOSCA Orchestrators and tooling.

72

73 The language provides an extension mechanism that can be used to extend the definitions with additional  
74 vendor-specific or domain-specific information.

## 75 1.5 Notational Conventions

76 The key words “MUST”, “MUST NOT”, “REQUIRED”, “SHALL”, “SHALL NOT”, “SHOULD”, “SHOULD  
77 NOT”, “RECOMMENDED”, “MAY”, and “OPTIONAL” in this document are to be interpreted as described  
78 in [RFC2119].

### 79 1.5.1 Notes

- 80 • Sections that are titled “Example” throughout this document are considered non-normative.



## 81 1.6 Normative References

Reference Tag	Description
[RFC2119]	S. Bradner, <i>Key words for use in RFCs to Indicate Requirement Levels</i> , <a href="http://www.ietf.org/rfc/rfc2119.txt">http://www.ietf.org/rfc/rfc2119.txt</a> , IETF RFC 2119, March 1997.
[TOSCA-1.0]	Topology and Orchestration Topology and Orchestration Specification for Cloud Applications (TOSCA) Version 1.0, an OASIS Standard, 25

November 2013, <http://docs.oasis-open.org/tosca/TOSCA/v1.0/os/TOSCA-v1.0-os.pdf>

[YAML-1.2]	YAML, Version 1.2, 3rd Edition, Patched at 2009-10-01, Oren Ben-Kiki, Clark Evans, Ingy döt Net <a href="http://www.yaml.org/spec/1.2/spec.html">http://www.yaml.org/spec/1.2/spec.html</a>
[YAML-TS-1.1]	Timestamp Language-Independent Type for YAML Version 1.1, Working Draft 2005-01-18, <a href="http://yaml.org/type/timestamp.html">http://yaml.org/type/timestamp.html</a>

## 82 1.7 Non-Normative References

Reference Tag	Description
[Apache]	Apache Server, <a href="https://httpd.apache.org/">https://httpd.apache.org/</a>
[Chef]	Chef, <a href="https://wiki.opscode.com/display/chef/Home">https://wiki.opscode.com/display/chef/Home</a>
[NodeJS]	Node.js, <a href="https://nodejs.org/">https://nodejs.org/</a>
[Puppet]	Puppet, <a href="http://puppetlabs.com/">http://puppetlabs.com/</a>
[WordPress]	WordPress, <a href="https://wordpress.org/">https://wordpress.org/</a>
[Maven-Version]	Apache Maven version policy draft: <a href="https://cwiki.apache.org/confluence/display/MAVEN/Version+number+policy">https://cwiki.apache.org/confluence/display/MAVEN/Version+number+policy</a>
[JSON-Spec]	The JSON Data Interchange Format (ECMA and IETF versions): <ul style="list-style-type: none"><li>• <a href="http://www.ecma-international.org/publications/files/ECMA-ST/ECMA-404.pdf">http://www.ecma-international.org/publications/files/ECMA-ST/ECMA-404.pdf</a></li><li>• <a href="https://tools.ietf.org/html/rfc7158">https://tools.ietf.org/html/rfc7158</a></li></ul>
[JSON-Schema]	JSON Schema specification: <ul style="list-style-type: none"><li>• <a href="http://json-schema.org/documentation.html">http://json-schema.org/documentation.html</a></li></ul>
[XMLSpec]	XML Specification, W3C Recommendation, February 1998, <a href="http://www.w3.org/TR/1998/REC-xml-19980210">http://www.w3.org/TR/1998/REC-xml-19980210</a>
[XML Schema Part 1]	XML Schema Part 1: Structures, W3C Recommendation, October 2004,  <a href="http://www.w3.org/TR/xmlschema-1/">http://www.w3.org/TR/xmlschema-1/</a>
[XML Schema Part 2]	XML Schema Part 2: Datatypes, W3C Recommendation, October 2004,  <a href="http://www.w3.org/TR/xmlschema-2/">http://www.w3.org/TR/xmlschema-2/</a>

## 83 1.8 Glossary

84 The following terms are used throughout this specification and have the following definitions when used in  
85 context of this document.

Term	Definition
<b>Instance Model</b>	A deployed service is a running instance of a Service Template. More precisely, the instance is derived by instantiating the Topology Template of its Service Template, most often by running a special plan defined for the Service Template, often referred to as build plan.
<b>Node Template</b>	A <i>Node Template</i> specifies the occurrence of a software component node as part of a Topology Template. Each Node Template refers to a Node Type that defines the semantics of the node (e.g., properties, attributes, requirements, capabilities, interfaces). Node Types are defined separately for reuse purposes.
<b>Relationship Template</b>	A Relationship Template specifies the occurrence of a relationship between nodes in a Topology Template. Each Relationship Template refers to a Relationship Type that defines the semantics relationship (e.g., properties,

attributes, interfaces, etc.). Relationship Types are defined separately for reuse purposes.

---

<b>Service Template</b>	<p>A Service Template is typically used to specify the “topology” (or structure) and “orchestration” (or invocation of management behavior) of IT services so that they can be provisioned and managed in accordance with constraints and policies.</p> <p>Specifically, TOSCA Service Templates optionally allow definitions of a TOSCA Topology Template, TOSCA types (e.g., Node, Relationship, Capability, Artifact, etc.), groupings, policies and constraints along with any input or output declarations.</p>
<b>Topology Model</b>	<p>The term Topology Model is often used synonymously with the term Topology Template with the use of “model” being prevalent when considering a Service Template’s topology definition as an abstract representation of an application or service to facilitate understanding of its functional components and by eliminating unnecessary details.</p>
<b>Topology Template</b>	<p>A Topology Template defines the structure of a service in the context of a Service Template. A Topology Template consists of a set of Node Template and Relationship Template definitions that together define the topology model of a service as a (not necessarily connected) directed graph.</p> <p>The term Topology Template is often used synonymously with the term <a href="#">Topology Model</a>. The distinction is that a topology template can be used to instantiate and orchestrate the model as a <b>reusable pattern</b> and includes all details necessary to accomplish it.</p>
<b>Abstract Node Template</b>	<p>An abstract node template is a node that doesn’t define an implementation artifact for the create operation of the TOSCA lifecycle.</p> <p>The create operation can be delegated to the TOSCA Orchestrator.</p> <p>Being delegated an abstract node may not be able to execute user provided implementation artifacts for operations post create (for example configure, start etc.).</p>
<b>No-Op Node Template</b>	<p>A No-Op node template is a specific abstract node template that does not specify any implementation for any operation.</p>

---

---

## 86 2 TOSCA by example

87 This **non-normative** section contains several sections that show how to model applications with TOSCA  
88 Simple Profile using YAML by example starting with a “Hello World” template up through examples that  
89 show complex composition modeling.

### 90 2.1 A “hello world” template for TOSCA Simple Profile in YAML

91 As mentioned before, the TOSCA simple profile assumes the existence of a small set of pre-defined,  
92 normative set of node types (e.g., a ‘Compute’ node) along with other types, which will be introduced  
93 through the course of this document, for creating TOSCA Service Templates. It is envisioned that many  
94 additional node types for building service templates will be created by communities some may be  
95 published as profiles that build upon the TOSCA Simple Profile specification. Using the normative TOSCA  
96 Compute node type, a very basic “Hello World” TOSCA template for deploying just a single server would  
97 look as follows:

98 *Example 1 - TOSCA Simple "Hello World"*

```
tosca_definitions_version: tosca_simple_yaml_1_0

description: Template for deploying a single server with predefined properties.

topology_template:
  node_templates:
    my_server:
      type: tosca.nodes.Compute
      capabilities:
        # Host container properties
        host:
          properties:
            num_cpus: 1
            disk_size: 10 GB
            mem_size: 4096 MB
        # Guest Operating System properties
        os:
          properties:
            # host Operating System image properties
            architecture: x86_64
            type: linux
            distribution: rhel
            version: 6.5
```

99 The template above contains a very simple topology template with only a single ‘Compute’ node template  
100 that declares some basic values for properties within two of the several capabilities that are built into the  
101 Compute node type definition. All TOSCA Orchestrators are expected to know how to instantiate a  
102 Compute node since it is normative and expected to represent a well-known function that is portable  
103 across TOSCA implementations. This expectation is true for all normative TOSCA Node and  
104 Relationship types that are defined in the Simple Profile specification. This means, with TOSCA’s

105 approach, that the application developer does not need to provide any deployment or implementation  
106 artifacts that contain code or logic to orchestrate these common software components. TOSCA  
107 orchestrators simply select or allocate the correct node (resource) type that fulfills the application  
108 topologies requirements using the properties declared in the node and its capabilities.

109 In the above example, the “**host**” capability contains properties that allow application developers to  
110 optionally supply the number of CPUs, memory size and disk size they believe they need when the  
111 Compute node is instantiated in order to run their applications. Similarly, the “**os**” capability is used to  
112 provide values to indicate what host operating system the Compute node should have when it is  
113 instantiated.

114

115 The logical diagram of the “hello world” Compute node would look as follows:

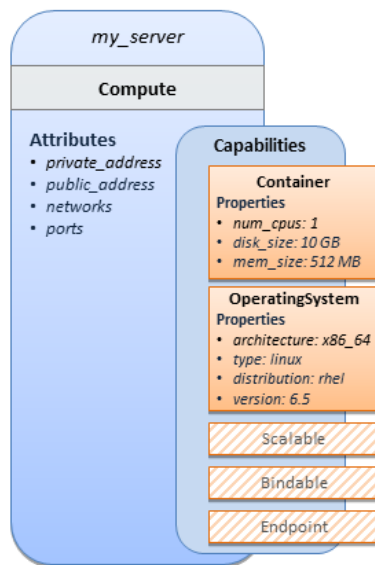

116

117

118 As you can see, the **Compute** node also has attributes and other built-in capabilities, such as **Bindable**  
119 and **Endpoint**, each with additional properties that will be discussed in other examples later in this  
120 document. Although the Compute node has no direct properties apart from those in its capabilities, other  
121 TOSCA node type definitions may have properties that are part of the node type itself in addition to  
122 having Capabilities. TOSCA orchestration engines are expected to validate all property values provided  
123 in a node template against the property definitions in their respective node type definitions referenced in  
124 the service template. The `tosca_definitions_version` keyname in the TOSCA service template  
125 identifies the versioned set of normative TOSCA type definitions to use for validating those types defined  
126 in the TOSCA Simple Profile including the Compute node type. Specifically, the value  
127 `tosca_simple_yaml_1_0` indicates Simple Profile v1.0.0 definitions would be used for validation. Other  
128 type definitions may be imported from other service templates using the `import` keyword discussed later.

## 129 2.1.1 Requesting input parameters and providing output

130 Typically, one would want to allow users to customize deployments by providing input parameters instead  
131 of using hardcoded values inside a template. In addition, output values are provided to pass information  
132 that perhaps describes the state of the deployed template to the user who deployed it (such as the private  
133 IP address of the deployed server). A refined service template with corresponding **inputs** and **outputs**  
134 sections is shown below.

135 *Example 2 - Template with input and output parameter sections*

```
tosca_definitions_version: toscasimple_yaml_1_0
```

```

description: Template for deploying a single server with predefined properties.

topology_template:
  inputs:
    cpus:
      type: integer
      description: Number of CPUs for the server.
      constraints:
        - valid_values: [ 1, 2, 4, 8 ]

  node_templates:
    my_server:
      type: toska.nodes.Compute
      capabilities:
        # Host container properties
        host:
          properties:
            # Compute properties
            num_cpus: { get_input: cpus }
            mem_size: 2048 MB
            disk_size: 10 GB

  outputs:
    server_ip:
      description: The private IP address of the provisioned server.
      value: { get_attribute: [ my_server, private_address ] }

```

136 The **inputs** and **outputs** sections are contained in the **topology\_template** element of the TOSCA  
 137 template, meaning that they are scoped to node templates within the topology template. Input parameters  
 138 defined in the inputs section can be assigned to properties of node template within the containing  
 139 topology template; output parameters can be obtained from attributes of node templates within the  
 140 containing topology template.

141 Note that the **inputs** section of a TOSCA template allows for defining optional constraints on each input  
 142 parameter to restrict possible user input. Further note that TOSCA provides for a set of intrinsic functions  
 143 like **get\_input**, **get\_property** or **get\_attribute** to reference elements within the template or to  
 144 retrieve runtime values.

## 145 2.2 TOSCA template for a simple software installation

146 Software installations can be modeled in TOSCA as node templates that get related to the node template  
 147 for a server on which the software would be installed. With a number of existing software node types (e.g.  
 148 either created by the TOSCA work group or a community) template authors can just use those node types  
 149 for writing service templates as shown below.

```

tosca_definitions_version: tosca_simple_yaml_1_0
description: Template for deploying a single server with MySQL software on top.

topology_template:
  inputs:
    # omitted here for brevity

  node_templates:
    mysql:
      type: tosca.nodes.DBMS.MySQL
      properties:
        root_password: { get_input: my_mysql_rootpw }
        port: { get_input: my_mysql_port }
      requirements:
        - host: db_server

    db_server:
      type: tosca.nodes.Compute
      capabilities:
        # omitted here for brevity

```

151 The example above makes use of a node type **tosca.nodes.DBMS.MySQL** for the **mysql** node template to  
 152 install MySQL on a server. This node type allows for setting a property **root\_password** to adapt the  
 153 password of the MySQL root user at deployment. The set of properties and their schema has been  
 154 defined in the node type definition. By means of the **get\_input** function, a value provided by the user at  
 155 deployment time is used as value for the **root\_password** property. The same is true for the **port**  
 156 property.

157 The **mysql** node template is related to the **db\_server** node template (of type **tosca.nodes.Compute**) via  
 158 the **requirements** section to indicate where MySQL is to be installed. In the TOSCA metamodel, nodes  
 159 get related to each other when one node has a requirement against some feature provided by another  
 160 node. What kinds of requirements exist is defined by the respective node type. In case of MySQL, which  
 161 is software that needs to be installed or hosted on a compute resource, the underlying node type named  
 162 **DBMS** has a predefined requirement called **host**, which needs to be fulfilled by pointing to a node template  
 163 of type **tosca.nodes.Compute**.

164 The logical relationship between the `mysql` node and its host `db_server` node would appear as follows:

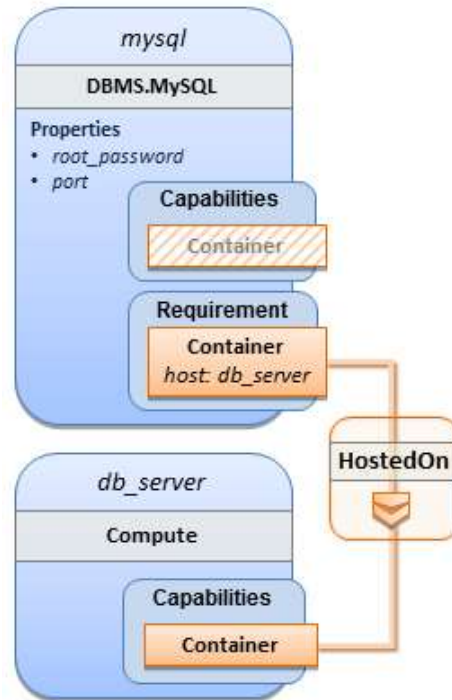

165

166 Within the **requirements** section, all entries simple entries are a map which contains the symbolic name  
167 of a requirement definition as the *key* and the identifier of the fulfilling node as the *value*. The value is  
168 essentially the symbolic name of the other node template; specifically, or the example above, the **host**  
169 requirement is fulfilled by referencing the `db_server` node template. The underlying TOSCA `DBMS` node  
170 type already defines a complete requirement definition for the **host** requirement of type `Container` and  
171 assures that a `HostedOn` TOSCA relationship will automatically be created and will only allow a valid  
172 target host node is of type `Compute`. This approach allows the template author to simply provide the  
173 name of a valid `Compute` node (i.e., `db_server`) as the value for the `mysql` node's **host** requirement and  
174 not worry about defining anything more complex if they do not want to.

### 175 2.3 Overriding behavior of predefined node types

176 Node types in TOSCA have associated implementations that provide the automation (e.g. in the form of  
177 scripts such as Bash, Chef or Python) for the normative lifecycle operations of a node. For example, the  
178 node type implementation for a MySQL database would associate scripts to TOSCA node operations like  
179 **configure**, **start**, or **stop** to manage the state of MySQL at runtime.

180 Many node types may already come with a set of operational scripts that contain basic commands that  
181 can manage the state of that specific node. If it is desired, template authors can provide a custom script  
182 for one or more of the operation defined by a node type in their node template which will override the  
183 default implementation in the type. The following example shows a `mysql` node template where the  
184 template author provides their own `configure` script:

185 *Example 4 - Node Template overriding its Node Type's "configure" interface*

```
tosca_definitions_version: tosca_simple_yaml_1_0

description: Template for deploying a single server with MySQL software on top.
```



```

topology_template:
  inputs:
    # omitted here for brevity

  node_templates:
    mysql:
      type: tosca.nodes.DBMS.MySQL
      properties:
        root_password: { get_input: my_mysql_rootpw }
        port: { get_input: my_mysql_port }
      requirements:
        - host: db_server
      interfaces:
        Standard:
          configure: scripts/my_own_configure.sh

    db_server:
      type: tosca.nodes.Compute
      capabilities:
        # omitted here for brevity

```

186 In the example above, the **my\_own\_configure.sh** script is provided for the **configure** operation of the  
 187 MySQL node type's **Standard** lifecycle interface. The path given in the example above (i.e., 'scripts/') is  
 188 interpreted relative to the template file, but it would also be possible to provide an absolute URI to the  
 189 location of the script.

190 In other words, operations defined by node types can be thought of as “hooks” into which automation can  
 191 be injected. Typically, node type implementations provide the automation for those “hooks”. However,  
 192 within a template, custom automation can be injected to run in a hook in the context of the one, specific  
 193 node template (i.e. without changing the node type).

## 194 2.4 TOSCA template for database content deployment

195 In the Example 4, shown above, the deployment of the MySQL middleware only, i.e. without actual  
 196 database content was shown. The following example shows how such a template can be extended to  
 197 also contain the definition of custom database content on-top of the MySQL DBMS software.

198 *Example 5 - Template for deploying database content on-top of MySQL DBMS middleware*

```

tosca_definitions_version: tosca_simple_yaml_1_0

description: Template for deploying MySQL and database content.

topology_template:
  inputs:
    # omitted here for brevity

```

```

node_templates:
  my_db:
    type: tosca.nodes.Database.MySQL
    properties:
      name: { get_input: database_name }
      user: { get_input: database_user }
      password: { get_input: database_password }
      port: { get_input: database_port }
    artifacts:
      db_content:
        file: files/my_db_content.txt
        type: tosca.artifacts.File
    requirements:
      - host: mysql
    interfaces:
      Standard:
        create:
          implementation: db_create.sh
        inputs:
          # Copy DB file artifact to server's staging area
          db_data: { get_artifact: [ SELF, db_content ] }

  mysql:
    type: tosca.nodes.DBMS.MySQL
    properties:
      root_password: { get_input: mysql_rootpw }
      port: { get_input: mysql_port }
    requirements:
      - host: db_server

  db_server:
    type: tosca.nodes.Compute
    capabilities:
      # omitted here for brevity

```

199 In the example above, the **my\_db** node template or type **tosca.nodes.Database.MySQL** represents an  
 200 actual MySQL database instance managed by a MySQL DBMS installation. The **requirements** section of  
 201 the **my\_db** node template expresses that the database it represents is to be hosted on a MySQL DBMS  
 202 node template named **mysql** which is also declared in this template.

203 In its **artifacts** section of the **my\_db** the node template, there is an artifact definition named **db\_content**  
 204 which represents a text file **my\_db\_content.txt** which in turn will be used to add content to the SQL

205 database as part of the **create** operation. The **requirements** section of the **my\_db** node template  
206 expresses that the database is hosted on a MySQL DBMS represented by the **mysql** node.

207 As you can see above, a script is associated with the create operation with the name **db\_create.sh**.  
208 The TOSCA Orchestrator sees that this is not a named artifact declared in the node's artifact section, but  
209 instead a filename for a normative TOSCA implementation artifact script type (i.e.,  
210 **tosca.artifacts.Implementation.Bash**). Since this is an implementation type for TOSCA, the  
211 orchestrator will execute the script automatically to create the node on **db\_server**, but first it will prepare  
212 the local environment with the declared inputs for the operation. In this case, the orchestrator would see  
213 that the **db\_data** input is using the **get\_artifact** function to retrieve the file (**my\_db\_content.txt**)  
214 which is associated with the **db\_content** artifact name prior to executing the **db\_create.sh** script.

215 The logical diagram for this example would appear as follows:

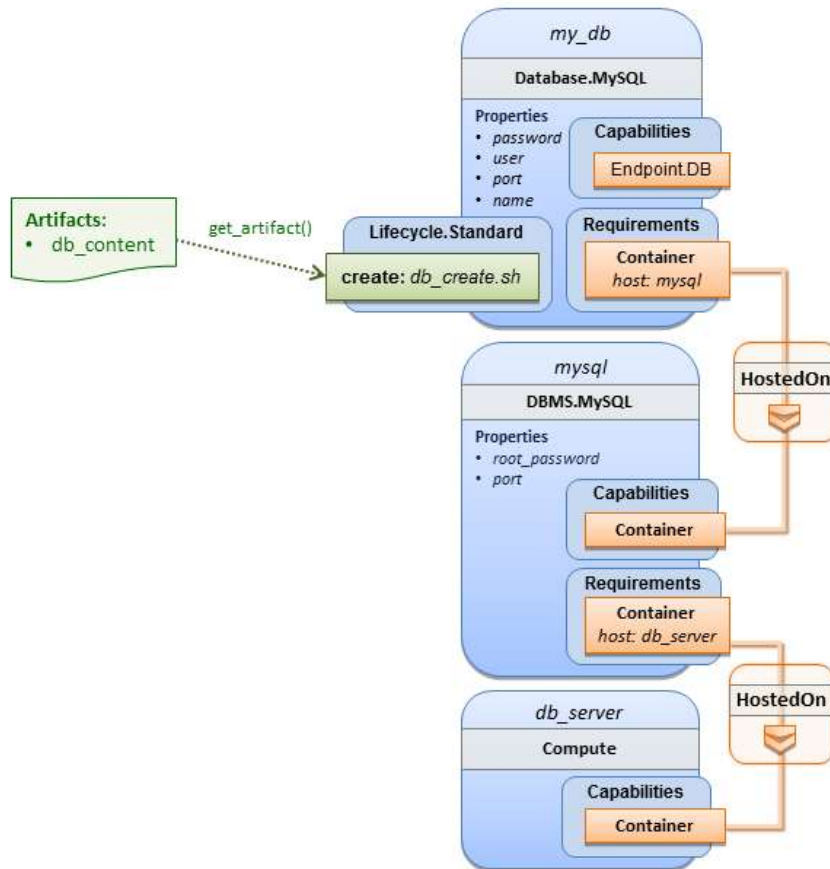

216 Note that while it would be possible to define one node type and corresponding node templates that  
217 represent both the DBMS middleware and actual database content as one entity, TOSCA normative node  
218 types distinguish between middleware (container) and application (containe) node types. This allows on  
219 one hand to have better re-use of generic middleware node types without binding them to content running  
220 on top of them, and on the other hand this allows for better substitutability of, for example, middleware  
221 components like a DBMS during the deployment of TOSCA models.  
222

## 223 2.5 TOSCA template for a two-tier application

224 The definition of multi-tier applications in TOSCA is quite similar to the example shown in section 2.2, with  
225 the only difference that multiple software node stacks (i.e., node templates for middleware and application  
226 layer components), typically hosted on different servers, are defined and related to each other. The  
227 example below defines a web application stack hosted on the **web\_server** “compute” resource, and a  
228 database software stack similar to the one shown earlier in section 6 hosted on the **db\_server** compute  
229 resource.

```

tosca_definitions_version: toska_simple_yaml_1_0

description: Template for deploying a two-tier application servers on two

topology_template:
  inputs:
    # Admin user name and password to use with the WordPress application
    wp_admin_username:
      type: string
    wp_admin_password:
      type: string
    wp_db_name:
      type: string
    wp_db_user:
      type: string
    wp_db_password:
      type: string
    wp_db_port:
      type: integer
    mysql_root_password:
      type: string
    mysql_port:
      type: integer
    context_root:
      type: string

  node_templates:
    wordpress:
      type: toska.nodes.WebApplication.WordPress
      properties:
        context_root: { get_input: context_root }
        admin_user: { get_input: wp_admin_username }
        admin_password: { get_input: wp_admin_password }
        db_host: { get_attribute: [ db_server, private_address ] }
      requirements:
        - host: apache
        - database_endpoint: wordpress_db
      interfaces:
        Standard:
          inputs:

```

```

    db_host: { get_attribute: [ db_server, private_address ] }
    db_port: { get_property: [ wordpress_db, port ] }
    db_name: { get_property: [ wordpress_db, name ] }
    db_user: { get_property: [ wordpress_db, user ] }
    db_password: { get_property: [ wordpress_db, password ] }

apache:
  type: tosca.nodes.WebServer.Apache
  properties:
    # omitted here for brevity
  requirements:
    - host: web_server

web_server:
  type: tosca.nodes.Compute
  capabilities:
    # omitted here for brevity

wordpress_db:
  type: tosca.nodes.Database.MySQL
  properties:
    name: { get_input: wp_db_name }
    user: { get_input: wp_db_user }
    password: { get_input: wp_db_password }
    port: { get_input: wp_db_port }
  requirements:
    - host: mysql

mysql:
  type: tosca.nodes.DBMS.MySQL
  properties:
    root_password: { get_input: mysql_root_password }
    port: { get_input: mysql_port }
  requirements:
    - host: db_server

db_server:
  type: tosca.nodes.Compute
  capabilities:
    # omitted here for brevity

```

231 The web application stack consists of the **wordpress** [WordPress], the **apache** [Apache] and the  
232 **web\_server** node templates. The **wordpress** node template represents a custom web application of type  
233 **tosca.nodes.WebApplication.WordPress** which is hosted on an Apache web server represented by the  
234 **apache** node template. This hosting relationship is expressed via the **host** entry in the **requirements**  
235 section of the **wordpress** node template. The **apache** node template, finally, is hosted on the  
236 **web\_server** compute node.

237 The database stack consists of the **wordpress\_db**, the **mysql** and the **db\_server** node templates. The  
238 **wordpress\_db** node represents a custom database of type **tosca.nodes.Database.MySQL** which is  
239 hosted on a MySQL DBMS represented by the **mysql** node template. This node, in turn, is hosted on the  
240 **db\_server** compute node.

241 The **wordpress** node requires a connection to the **wordpress\_db** node, since the WordPress application  
242 needs a database to store its data in. This relationship is established through the **database\_endpoint**  
243 entry in the **requirements** section of the **wordpress** node template's declared node type. For configuring  
244 the WordPress web application, information about the database to connect to is required as input to the  
245 **configure** operation. Therefore, the input parameters are defined and values for them are retrieved from  
246 the properties and attributes of the **wordpress\_db** node via the **get\_property** and **get\_attribute**  
247 functions. In the above example, these inputs are defined at the interface-level and would be available to  
248 all operations of the **Standard** interface (i.e., the **tosca.interfaces.node.lifecycle.Standard**  
249 interface) within the **wordpress** node template and not just the **configure** operation.

## 250 2.6 Using a custom script to establish a relationship in a template

251 In previous examples, the template author did not have to think about explicit relationship types to be  
252 used to link a requirement of a node to another node of a model, nor did the template author have to think  
253 about special logic to establish those links. For example, the **host** requirement in previous examples just  
254 pointed to another node template and based on metadata in the corresponding node type definition the  
255 relationship type to be established is implicitly given.

256 In some cases, it might be necessary to provide special processing logic to be executed when  
257 establishing relationships between nodes at runtime. For example, when connecting the WordPress  
258 application from previous examples to the MySQL database, it might be desired to apply custom  
259 configuration logic in addition to that already implemented in the application node type. In such a case, it  
260 is possible for the template author to provide a custom script as implementation for an operation to be  
261 executed at runtime as shown in the following example.

262 *Example 7 - Providing a custom relationship script to establish a connection*

```
tosca_definitions_version: tosca_simple_yaml_1_0

description: Template for deploying a two-tier application on two servers.

topology_template:
  inputs:
    # omitted here for brevity

  node_templates:
    wordpress:
      type: tosca.nodes.WebApplication.WordPress
      properties:
        # omitted here for brevity
      requirements:
```

```

- host: apache
- database_endpoint:
  node: wordpress_db
  relationship: my_custom_database_connection

wordpress_db:
  type: toska.nodes.Database.MySQL
  properties:
    # omitted here for the brevity
  requirements:
    - host: mysql

relationship_templates:
  my_custom_database_connection:
    type: ConnectsTo
    interfaces:
      Configure:
        pre_configure_source: scripts/wp_db_configure.sh

# other resources not shown for this example ...

```

263 The node type definition for the **wordpress** node template is **WordPress** which declares the complete  
264 **database\_endpoint** requirement definition. This **database\_endpoint** declaration indicates it must be  
265 fulfilled by any node template that provides an **Endpoint.Database** Capability Type using a **ConnectsTo**  
266 relationship. The **wordpress\_db** node template's underlying **MySQL** type definition indeed provides the  
267 **Endpoint.Database** Capability type. In this example however, no explicit relationship template is  
268 declared; therefore, TOSCA orchestrators would automatically create a **ConnectsTo** relationship to  
269 establish the link between the **wordpress** node and the **wordpress\_db** node at runtime.

270 The **ConnectsTo** relationship (see 5.7.4) also provides a default **Configure** interface with operations that  
271 optionally get executed when the orchestrator establishes the relationship. In the above example, the  
272 author has provided the custom script **wp\_db\_configure.sh** to be executed for the operation called  
273 **pre\_configure\_source**. The script file is assumed to be located relative to the referencing service  
274 template such as a relative directory within the TOSCA Cloud Service Archive (CSAR) packaging format.  
275 This approach allows for conveniently hooking in custom behavior without having to define a completely  
276 new derived relationship type.

## 277 2.7 Using custom relationship types in a TOSCA template

278 In the previous section it was shown how custom behavior can be injected by specifying scripts inline in  
279 the requirements section of node templates. When the same custom behavior is required in many  
280 templates, it does make sense to define a new relationship type that encapsulates the custom behavior in  
281 a re-usable way instead of repeating the same reference to a script (or even references to multiple  
282 scripts) in many places.

283 Such a custom relationship type can then be used in templates as shown in the following example.

```

tosca_definitions_version: tosca_simple_yaml_1_0

description: Template for deploying a two-tier application on two servers.

topology_template:
  inputs:
    # omitted here for brevity

  node_templates:
    wordpress:
      type: tosca.nodes.WebApplication.WordPress
      properties:
        # omitted here for brevity
      requirements:
        - host: apache
        - database_endpoint:
            node: wordpress_db
            relationship: my.types.WordpressDbConnection

    wordpress_db:
      type: tosca.nodes.Database.MySQL
      properties:
        # omitted here for the brevity
      requirements:
        - host: mysql

# other resources not shown here ...

```

285 In the example above, a special relationship type **my.types.WordpressDbConnection** is specified for  
 286 establishing the link between the **wordpress** node and the **wordpress\_db** node through the use of the  
 287 **relationship** (keyword) attribute in the **database** reference. It is assumed, that this special relationship  
 288 type provides some extra behavior (e.g., an operation with a script) in addition to what a generic  
 289 “connects to” relationship would provide. The definition of this custom relationship type is shown in the  
 290 following section.

### 291 2.7.1 Definition of a custom relationship type

292 The following YAML snippet shows the definition of the custom relationship type used in the previous  
 293 section. This type derives from the base “ConnectsTo” and overrides one operation defined by that base  
 294 relationship type. For the **pre\_configure\_source** operation defined in the **Configure** interface of the  
 295 ConnectsTo relationship type, a script implementation is provided. It is again assumed that the custom  
 296 configure script is located at a location relative to the referencing service template, perhaps provided in  
 297 some application packaging format (e.g., the TOSCA Cloud Service Archive (CSAR) format).



```

tosca_definitions_version: tosca_simple_yaml_1_0

description: Definition of custom WordpressDbConnection relationship type

relationship_types:
  my.types.WordpressDbConnection:
    derived_from: tosca.relationships.ConnectsTo
    interfaces:
      Configure:
        pre_configure_source: scripts/wp_db_configure.sh

```

299 In the above example, the **Configure** interface is the specified alias or shorthand name for the TOSCA  
 300 interface type with the full name of **tosca.interfaces.relationship.Configure** which is defined in  
 301 the appendix.

## 302 2.8 Defining generic dependencies between nodes in a template

303 In some cases, it can be necessary to define a generic dependency between two nodes in a template to  
 304 influence orchestration behavior, i.e. to first have one node processed before another dependent node  
 305 gets processed. This can be done by using the generic **dependency** requirement which is defined by the  
 306 [TOSCA Root Node Type](#) and thus gets inherited by all other node types in TOSCA (see section 5.9.1).

307 *Example 10 - Simple dependency relationship between two nodes*

```

tosca_definitions_version: tosca_simple_yaml_1_0

description: Template with a generic dependency between two nodes.

topology_template:
  inputs:
    # omitted here for brevity

  node_templates:
    my_app:
      type: my.types.MyApplication
      properties:
        # omitted here for brevity
      requirements:
        - dependency: some_service

    some_service:
      type: some.nodetype.SomeService
      properties:
        # omitted here for brevity

```

308 As in previous examples, the relation that one node depends on another node is expressed in the  
309 **requirements** section using the built-in requirement named **dependency** that exists for all node types in  
310 TOSCA. Even if the creator of the **MyApplication** node type did not define a specific requirement for  
311 **SomeService** (similar to the **database** requirement in the example in section 2.6), the template author  
312 who knows that there is a timing dependency and can use the generic **dependency** requirement to  
313 express that constraint using the very same syntax as used for all other references.

## 314 2.9 Describing abstract requirements for nodes and capabilities in a 315 TOSCA template

316 In TOSCA templates, nodes are either:

- 317 • **Concrete**: meaning that they have a deployment and/or one or more implementation artifacts that  
318 are declared on the “create” operation of the node’s Standard lifecycle interface, or they are
- 319 • **Abstract**: where the template describes the node type along with its required capabilities and  
320 properties that must be satisfied.

321  
322 TOSCA Orchestrators, by default, when finding an abstract node in TOSCA Service Template during  
323 deployment will attempt to “select” a concrete implementation for the abstract node type that best  
324 matches and fulfills the requirements and property constraints the template author provided for that  
325 abstract node. The concrete implementation of the node could be provided by another TOSCA Service  
326 Template (perhaps located in a catalog or repository known to the TOSCA Orchestrator) or by an existing  
327 resource or service available within the target Cloud Provider’s platform that the TOSCA Orchestrator  
328 already has knowledge of.

329  
330 TOSCA supports two methods for template authors to express requirements for an abstract node within a  
331 TOSCA service template.

- 332  
333 1. **Using a target node filter**: where a node template can describe a requirement (relationship) for  
334 another node without including it in the topology. Instead, the node provides a `node_filter` to  
335 describe the target node type along with its capabilities and property constraints
- 336  
337 2. **Using an abstract node template**: that describes the abstract node’s type along with its property  
338 constraints and any requirements and capabilities it also exports. This first method you have  
339 already seen in examples from previous chapters where the Compute node is abstract and  
340 selectable by the TOSCA Orchestrator using the supplied `Container` and `OperatingSystem`  
341 capabilities property constraints.

342  
343 These approaches allow architects and developers to create TOSCA service templates that are  
344 composable and can be reused by allowing flexible matching of one template’s requirements to another’s  
345 capabilities. Examples of both these approaches are shown below.

346  
347 The following section describe how a user can define a requirement for an orchestrator to select an  
348 implementation and replace a node. For more details on how an orchestrator may perform matching and  
349 select a node from it’s catalog(s) you may look at section 14 of the specification.

### 350 2.9.1 Using a `node_filter` to define hosting infrastructure requirements for a 351 software

352 Using TOSCA, it is possible to define only the software components of an application in a template and  
353 just express constrained requirements against the hosting infrastructure. At deployment time, the provider

354 can then do a late binding and dynamically allocate or assign the required hosting infrastructure and  
355 place software components on top.

356 This example shows how a single software component (i.e., the mysql node template) can define its **host**  
357 requirements that the TOSCA Orchestrator and provider will use to select or allocate an appropriate host  
358 **Compute** node by using matching criteria provided on a **node\_filter**.

359 *Example 11 - An abstract "host" requirement using a node filter*

```
tosca_definitions_version: tosca_simple_yaml_1_0

description: Template with requirements against hosting infrastructure.

topology_template:
  inputs:
    # omitted here for brevity

  node_templates:
    mysql:
      type: tosca.nodes.DBMS.MySQL
      properties:
        # omitted here for brevity
      requirements:
        - host:
            node_filter:
              capabilities:
                # Constraints for selecting "host" (Container Capability)
                - host:
                    properties:
                      - num_cpus: { in_range: [ 1, 4 ] }
                      - mem_size: { greater_or_equal: 2 GB }
                # Constraints for selecting "os" (OperatingSystem Capability)
                - os:
                    properties:
                      - architecture: { equal: x86_64 }
                      - type: linux
                      - distribution: ubuntu
```

360 In the example above, the **mysql** component contains a **host** requirement for a node of type **Compute**  
361 which it inherits from its parent DBMS node type definition; however, there is no declaration or reference  
362 to any node template of type **Compute**. Instead, the **mysql** node template augments the abstract "**host**"  
363 requirement with a **node\_filter** which contains additional selection criteria (in the form of property  
364 constraints that the provider must use when selecting or allocating a host **Compute** node.

365 Some of the constraints shown above narrow down the boundaries of allowed values for certain  
366 properties such as **mem\_size** or **num\_cpus** for the "**host**" capability by means of qualifier functions such  
367 as **greater\_or\_equal**. Other constraints, express specific values such as for the **architecture** or  
368 **distribution** properties of the "**os**" capability which will require the provider to find a precise match.

369 Note that when no qualifier function is provided for a property (filter), such as for the **distribution**  
370 property, it is interpreted to mean the **equal** operator as shown on the **architecture** property.

## 371 2.9.2 Using an abstract node template to define infrastructure requirements 372 for software

373 This previous approach works well if no other component (i.e., another node template) other than **mysql**  
374 node template wants to reference the same **Compute** node the orchestrator would instantiate. However,  
375 perhaps another component wants to also be deployed on the same host, yet still allow the flexible  
376 matching achieved using a node-filter. The alternative to the above approach is to create an abstract  
377 node template that represents the **Compute** node in the topology as follows:

378 *Example 12 - An abstract Compute node template with a node filter*

```
tosca_definitions_version: toska_simple_yaml_1_0

description: Template with requirements against hosting infrastructure.

topology_template:
  inputs:
    # omitted here for brevity

  node_templates:
    mysql:
      type: toska.nodes.DBMS.MySQL
      properties:
        # omitted here for brevity
      requirements:
        - host: mysql_compute

# Abstract node template (placeholder) to be selected by provider
mysql_compute:
  type: Compute
  node_filter:
    capabilities:
      - host:
          properties:
            num_cpus: { equal: 2 }
            mem_size: { greater_or_equal: 2 GB }
      - os:
          properties:
            architecture: { equal: x86_64 }
            type: linux
            distribution: ubuntu
```

379 As you can see the resulting **mysql\_compute** node template looks very much like the “hello world”  
380 template as shown in [Chapter 2.1](#) (where the **Compute** node template was abstract), but this one also  
381 allows the TOSCA orchestrator more flexibility when “selecting” a host **Compute** node by providing flexible  
382 constraints for properties like **mem\_size**.

383 As we proceed, you will see that TOSCA provides many normative node types like **Compute** for  
384 commonly found services (e.g., **BlockStorage**, **WebServer**, **Network**, etc.). When these TOSCA  
385 normative node types are used in your application’s topology they are always assumed to be “selectable”  
386 by TOSCA Orchestrators which work with target infrastructure providers to find or allocate the best match  
387 for them based upon your application’s requirements and constraints.

### 388 2.9.3 Using a `node_filter` to define requirements on a database for an 389 application

390 In the same way requirements can be defined on the hosting infrastructure (as shown above) for an  
391 application, it is possible to express requirements against application or middleware components such as  
392 a database that is not defined in the same template. The provider may then allocate a database by any  
393 means, (e.g. using a database-as-a-service solution).

394 *Example 13 - An abstract database requirement using a node filter*

```
tosca_definitions_version: tosca_simple_yaml_1_0

description: Template with a TOSCA Orchestrator selectable database requirement
using a node_filter.

topology_template:
  inputs:
    # omitted here for brevity

  node_templates:
    my_app:
      type: my.types.MyApplication
      properties:
        admin_user: { get_input: admin_username }
        admin_password: { get_input: admin_password }
        db_endpoint_url: { get_property: [SELF, database_endpoint, url_path ] }
      requirements:
        - database_endpoint:
            node: my.types.nodes.MyDatabase
            node_filter:
              properties:
                - db_version: { greater_or_equal: 5.5 }
```

395 In the example above, the application `my_app` requires a database node of type `MyDatabase` which has a  
396 `db_version` property value of `greater_or_equal` to the value 5.5.

397 This example also shows how the `get_property` intrinsic function can be used to retrieve the `url_path`  
398 property from the database node that will be selected by the provider and connected to `my_app` at runtime  
399 due to fulfillment of the `database_endpoint` requirement. To locate the property, the `get_property`'s first  
400 argument is set to the keyword `SELF` which indicates the property is being referenced from something in  
401 the node itself. The second parameter is the name of the requirement named `database_endpoint` which  
402 contains the property we are looking for. The last argument is the name of the property itself (i.e.,  
403 `url_path`) which contains the value we want to retrieve and assign to `db_endpoint_url`.

404 The alternative representation, which includes a node template in the topology for database that is still  
405 selectable by the TOSCA orchestrator for the above example, is as follows:

```

tosca_definitions_version: toska_simple_yaml_1_0

description: Template with a TOSCA Orchestrator selectable database using node
template.

topology_template:
  inputs:
    # omitted here for brevity

  node_templates:
    my_app:
      type: my.types.MyApplication
      properties:
        admin_user: { get_input: admin_username }
        admin_password: { get_input: admin_password }
        db_endpoint_url: { get_property: [SELF, database_endpoint, url_path ] }
      requirements:
        - database_endpoint: my_abstract_database

    my_abstract_database:
      type: my.types.nodes.MyDatabase
      properties:
        - db_version: { greater_or_equal: 5.5 }

```

## 407 2.10 Using node template substitution for model composition

408 From an application perspective, it is often not necessary or desired to dive into platform details, but the  
 409 platform/runtime for an application is abstracted. In such cases, the template for an application can use  
 410 generic representations of platform components. The details for such platform components, such as the  
 411 underlying hosting infrastructure at its configuration, can then be defined in separate template files that  
 412 can be used for substituting the more abstract representations in the application level template file.

### 413 2.10.1 Understanding node template instantiation through a TOSCA 414 Orchestrator

415 When a topology template is instantiated by a TOSCA Orchestrator, the orchestrator has to look for  
 416 realizations of abstract nodes in the topology template according to the node types specified for each  
 417 abstract node template. Such realizations can either be node types that include the appropriate  
 418 implementation artifacts and deployment artifacts that can be used by the orchestrator to bring to life the  
 419 real-world resource modeled by a node template. Alternatively, separate topology templates may be  
 420 annotated as being suitable for realizing a node template in the top-level topology template.

421  
 422 In the latter case, a TOSCA Orchestrator will use additional substitution mapping information provided as  
 423 part of the substituting topology templates to derive how the substituted part gets “wired” into the overall  
 424 deployment, for example, how capabilities of a node template in the top-level topology template get  
 425 bound to capabilities of node templates in the substituting topology template.

426

427 Thus, in cases where no “normal” node type implementation is available, or the node type corresponds to  
428 a whole subsystem that cannot be implemented as a single node, additional topology templates can be  
429 used for filling in more abstract placeholders in top level application templates.

### 430 2.10.2 Definition of the top-level service template

431 The following sample defines a web application **web\_app** connected to a database **db**. In this example, the  
432 complete hosting stack for the application is defined within the same topology template: the web  
433 application is hosted on a web server **web\_server**, which in turn is installed (hosted) on a compute node  
434 **server**.

435 The hosting stack for the database **db**, in contrast, is not defined within the same file but only the  
436 database is represented as a node template of type **tosca.nodes.Database**. The underlying hosting  
437 stack for the database is defined in a separate template file, which is shown later in this section. Within  
438 the current template, only a number of properties (**user**, **password**, **name**) are assigned to the database  
439 using hardcoded values in this simple example.

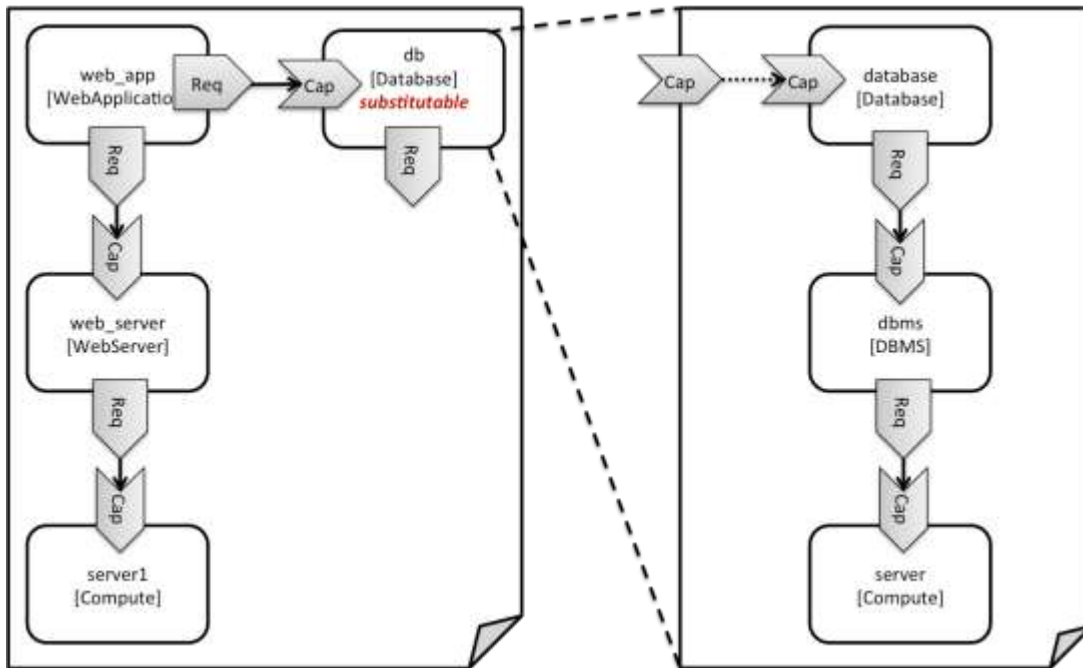

440

441 *Figure 1: Using template substitution to implement a database tier*

442 When a node template is to be substituted by another service template, this has to be indicated to an  
443 orchestrator by means of a special “*substitutable*” directive. This directive causes, for example, special  
444 processing behavior when validating the left-hand service template in Figure 1. The hosting requirement  
445 of the **db** node template is not bound to any capability defined within the service template, which would  
446 normally cause a validation error. When the “*substitutable*” directive is present, the orchestrator will  
447 however first try to perform substitution of the respective node template and after that validate if all  
448 mandatory requirements of all nodes in the resulting graph are fulfilled.

449

450 Note that in contrast to the use case described in section 2.9.2 (where a database was abstractly referred  
451 to in the **requirements** section of a node and the database itself was not represented as a node  
452 template), the approach shown here allows for some additional modeling capabilities in cases where this  
453 is required.

454

455 For example, if multiple components need to use the same database (or any other sub-system of the

456 overall service), this can be expressed by means of normal relations between node templates, whereas  
457 such modeling would not be possible in **requirements** sections of disjoint node templates.

458 *Example 15 - Referencing an abstract database node template*

```
tosca_definitions_version: tosca_simple_yaml_1_0

topology_template:
  description: Template of an application connecting to a database.

  node_templates:
    web_app:
      type: tosca.nodes.WebApplication.MyWebApp
      requirements:
        - host: web_server
        - database_endpoint: db

    web_server:
      type: tosca.nodes.WebServer
      requirements:
        - host: server

    server:
      type: tosca.nodes.Compute
      # details omitted for brevity

    db:
      # This node is abstract (no Deployment or Implementation artifacts on
      # create)
      # and can be substituted with a topology provided by another template
      # that exports a Database type's capabilities.
      type: tosca.nodes.Database
      properties:
        user: my_db_user
        password: secret
        name: my_db_name
```

### 459 **2.10.3 Definition of the database stack in a service template**

460 The following sample defines a template for a database including its complete hosting stack, i.e. the  
461 template includes a **database** node template, a template for the database management system (**dbms**)  
462 hosting the database, as well as a computer node **server** on which the DBMS is installed.

463 This service template can be used standalone for deploying just a database and its hosting stack. In the  
464 context of the current use case, though, this template can also substitute the database node template in  
465 the previous snippet and thus fill in the details of how to deploy the database.



466 In order to enable such a substitution, an additional metadata section **substitution\_mappings** is added  
 467 to the topology template to tell a TOSCA Orchestrator how exactly the topology template will fit into the  
 468 context where it gets used. For example, requirements or capabilities of the node that gets substituted by  
 469 the topology template have to be mapped to requirements or capabilities of internal node templates for  
 470 allow for a proper wiring of the resulting overall graph of node templates.

471 In short, the **substitution\_mappings** section provides the following information:

- 472 1. It defines what node templates, i.e. node templates of which type, can be substituted by the  
 473 topology template.
- 474 2. It defines how capabilities of the substituted node (or the capabilities defined by the node type of  
 475 the substituted node template, respectively) are bound to capabilities of node templates defined  
 476 in the topology template.
- 477 3. It defines how requirements of the substituted node (or the requirements defined by the node type  
 478 of the substituted node template, respectively) are bound to requirements of node templates  
 479 defined in the topology template.

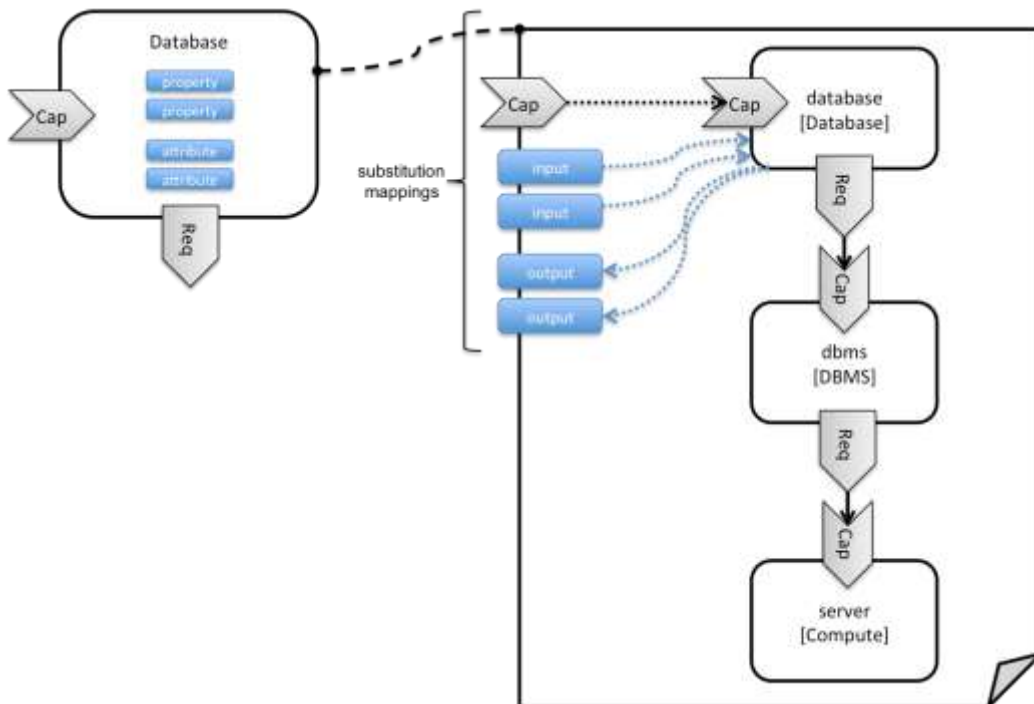

480  
 481 *Figure 2: Substitution mappings*

482 The **substitution\_mappings** section in the sample below denotes that this topology template can be  
 483 used for substituting node templates of type **tosca.nodes.Database**. It further denotes that the  
 484 **database\_endpoint** capability of the substituted node gets fulfilled by the **database\_endpoint**  
 485 capability of the **database** node contained in the topology template.

486 *Example 16 - Using substitution mappings to export a database implementation*

```
tosca_definitions_version: tosca_simple_yaml_1_0

topology_template:
  description: Template of a database including its hosting stack.

  inputs:
```

```

db_user:
  type: string
db_password:
  type: string
# other inputs omitted for brevity

substitution_mappings:
  node_type: tosca.nodes.Database
  capabilities:
    database_endpoint: [ database, database_endpoint ]

node_templates:
  database:
    type: tosca.nodes.Database
    properties:
      user: { get_input: db_user }
      # other properties omitted for brevity
    requirements:
      - host: dbms

  dbms:
    type: tosca.nodes.DBMS
    # details omitted for brevity

  server:
    type: tosca.nodes.Compute
    # details omitted for brevity

```

487 Note that the **substitution\_mappings** section does not define any mappings for requirements of the  
488 Database node type, since all requirements are fulfilled by other nodes templates in the current topology  
489 template. In cases where a requirement of a substituted node is bound in the top-level service template  
490 as well as in the substituting topology template, a TOSCA Orchestrator should raise a validation error.

491 Further note that no mappings for properties or attributes of the substituted node are defined. Instead, the  
492 inputs and outputs defined by the topology template are mapped to the appropriate properties and  
493 attributes of the substituted node. If there are more inputs than the substituted node has properties,  
494 default values must be defined for those inputs, since no values can be assigned through properties in a  
495 substitution case.

## 496 2.11 Using node template substitution for chaining subsystems

497 A common use case when providing an end-to-end service is to define a chain of several subsystems that  
498 together implement the overall service. Those subsystems are typically defined as separate service  
499 templates to (1) keep the complexity of the end-to-end service template at a manageable level and to (2)  
500 allow for the re-use of the respective subsystem templates in many different contexts. The type of  
501 subsystems may be specific to the targeted workload, application domain, or custom use case. For  
502 example, a company or a certain industry might define a subsystem type for company- or industry specific

503 data processing and then use that subsystem type for various end-user services. In addition, there might  
504 be generic subsystem types like a database subsystem that are applicable to a wide range of use cases.

### 505 2.11.1 Defining the overall subsystem chain

506 Figure 3 shows the chaining of three subsystem types – a message queuing subsystem, a transaction  
507 processing subsystem, and a databank subsystem – that support, for example, an online booking  
508 application. On the front end, this chain provides a capability of receiving messages for handling in the  
509 message queuing subsystem. The message queuing subsystem in turn requires a number of receivers,  
510 which in the current example are two transaction processing subsystems. The two instances of the  
511 transaction processing subsystem might be deployed on two different hosting infrastructures or  
512 datacenters for high-availability reasons. The transaction processing subsystems finally require a  
513 database subsystem for accessing and storing application specific data. The database subsystem in the  
514 backend does not require any further component and is therefore the end of the chain in this example.

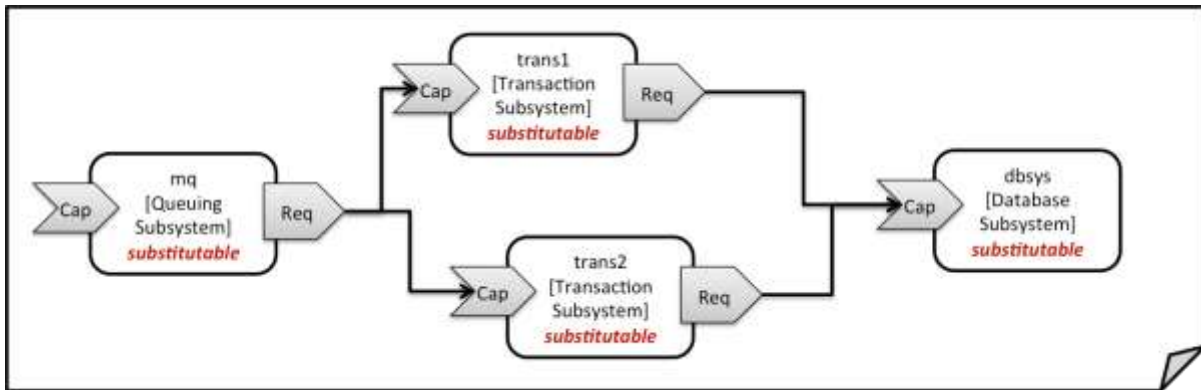

515

516 *Figure 3: Chaining of subsystems in a service template*

517 All of the node templates in the service template shown above are abstract and considered substitutable  
518 where each can be treated as their own subsystem; therefore, when instantiating the overall service, the  
519 orchestrator would realize each substitutable node template using other TOSCA service templates.  
520 These service templates would include more nodes and relationships that include the details for each  
521 subsystem. A simplified version of a TOSCA service template for the overall service is given in the  
522 following listing.

523

524 *Example 17 - Declaring a transaction subsystem as a chain of substitutable node templates*

```
tosca_definitions_version: tosca_simple_yaml_1_0

topology_template:
  description: Template of online transaction processing service.

  node_templates:
    mq:
      type: example.QueuingSubsystem
      properties:
        # properties omitted for brevity
      capabilities:
        message_queue_endpoint:
          # details omitted for brevity
```

```

requirements:
  - receiver: trans1
  - receiver: trans2

trans1:
  type: example.TransactionSubsystem
  properties:
    mq_service_ip: { get_attribute: [ mq, service_ip ] }
    receiver_port: 8080
  capabilities:
    message_receiver:
      # details omitted for brevity
  requirements:
    - database_endpoint: dbsys

trans2:
  type: example.TransactionSubsystem
  properties:
    mq_service_ip: { get_attribute: [ mq, service_ip ] }
    receiver_port: 8080
  capabilities:
    message_receiver:
      # details omitted for brevity
  requirements:
    - database_endpoint: dbsys

dbsys:
  type: example.DatabaseSubsystem
  properties:
    # properties omitted for brevity
  capabilities:
    database_endpoint:
      # details omitted for brevity

```

525

526 As can be seen in the example above, the subsystems are chained to each other by binding requirements  
 527 of one subsystem node template to other subsystem node templates that provide the respective  
 528 capabilities. For example, the **receiver** requirement of the message queuing subsystem node template  
 529 **mq** is bound to transaction processing subsystem node templates **trans1** and **trans2**.

530 Subsystems can be parameterized by providing properties. In the listing above, for example, the IP  
 531 address of the message queuing server is provided as property **mq\_service\_ip** to the transaction  
 532 processing subsystems and the desired port for receiving messages is specified by means of the  
 533 **receiver\_port** property.

534 If attributes of the instantiated subsystems need to be obtained, this would be possible by using the  
535 **get\_attribute** intrinsic function on the respective subsystem node templates.

## 536 2.11.2 Defining a subsystem (node) type

537 The types of subsystems that are required for a certain end-to-end service are defined as TOSCA node  
538 types as shown in the following example. Node templates of those node types can then be used in the  
539 end-to-end service template to define subsystems to be instantiated and chained for establishing the end-  
540 to-end service.

541 The realization of the defined node type will be given in the form of a whole separate service template as  
542 outlined in the following section.

543

544 *Example 18 - Defining a TransactionSubsystem node type*

```
tosca_definitions_version: tosca_simple_yaml_1_1_0

node_types:
  example.TransactionSubsystem:
    properties:
      mq_service_ip:
        type: string
      receiver_port:
        type: integer
    attributes:
      receiver_ip:
        type: string
      receiver_port:
        type: integer
    capabilities:
      message_receiver: tosca.capabilities.Endpoint
    requirements:
      - database_endpoint: tosca.capabilities.Endpoint.Database
```

545

546 Configuration parameters that would be allowed for customizing the instantiation of any subsystem are  
547 defined as properties of the node type. In the current example, those are the properties **mq\_service\_ip**  
548 and **receiver\_port** that had been used in the end-to-end service template in section 2.11.1.

549 Observable attributes of the resulting subsystem instances are defined as attributes of the node type. In  
550 the current case, those are the IP address of the message receiver as well as the actually allocated port  
551 of the message receiver endpoint.

## 552 2.11.3 Defining the details of a subsystem

553 The details of a subsystem, i.e. the software components and their hosting infrastructure, are defined as  
554 node templates and relationships in a service template. By means of substitution mappings that have  
555 been introduced in section 2.10.2, the service template is annotated to indicate to an orchestrator that it  
556 can be used as realization of a node template of certain type, as well as how characteristics of the node  
557 type are mapped to internal elements of the service template.

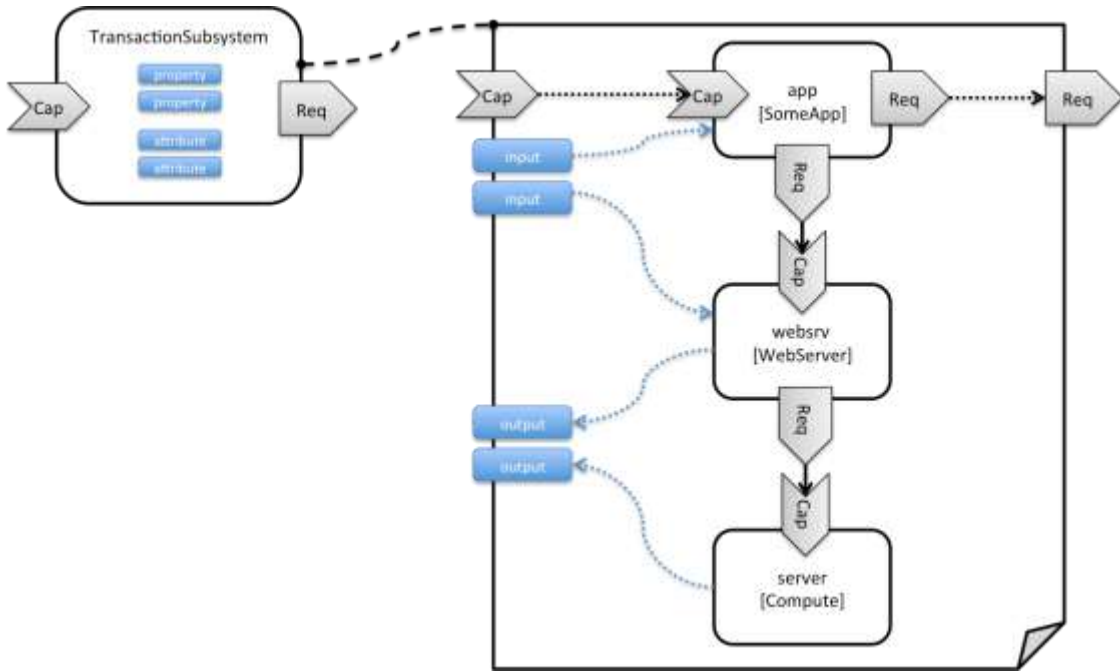

559

560

Figure 4: Defining subsystem details in a service template

561

562

563

Figure 1 illustrates how a transaction processing subsystem as outlined in the previous section could be defined in a service template. In this example, it simply consists of a custom application **app** of type **SomeApp** that is hosted on a web server **websrv**, which in turn is running on a compute node.

564

565

566

567

The application named **app** provides a capability to receive messages, which is bound to the **message\_receiver** capability of the substitutable node type. It further requires access to a database, so the application's **database\_endpoint** requirement is mapped to the **database\_endpoint** requirement of the **TransactionSubsystem** node type.

568

569

570

571

572

573

574

Properties of the **TransactionSubsystem** node type are used to customize the instantiation of a subsystem. Those properties can be mapped to any node template for which the author of the subsystem service template wants to expose configurability. In the current example, the application **app** and the web server middleware **websrv** get configured through properties of the **TransactionSubsystem** node type. All properties of that node type are defined as **inputs** of the service template. The input parameters in turn get mapped to node templates by means of **get\_input** function calls in the respective sections of the service template.

575

576

577

578

Similarly, attributes of the whole subsystem can be obtained from attributes of particular node templates. In the current example, attributes of the web server and the hosting compute node will be exposed as subsystem attributes. All exposed attributes that are defined as attributes of the substitutable **TransactionSubsystem** node type are defined as outputs of the subsystem service template.

579

580

581

582

583

An outline of the subsystem service template is shown in the listing below. Note that this service template could be used for stand-alone deployment of a transaction processing system as well, i.e. it is not restricted just for use in substitution scenarios. Only the presence of the **substitution\_mappings** metadata section in the **topology\_template** enables the service template for substitution use cases.

584

Example 19 - Implementation of a **TransactionSubsystem** node type using substitution mappings

```
tosca_definitions_version: tosca_simple_yaml_1_0
```

```

topology_template:
  description: Template of a database including its hosting stack.

  inputs:
    mq_service_ip:
      type: string
      description: IP address of the message queuing server to receive messages
    from
    receiver_port:
      type: string
      description: Port to be used for receiving messages
    # other inputs omitted for brevity

  substitution_mappings:
    node_type: example.TransactionSubsystem
    capabilities:
      message_receiver: [ app, message_receiver ]
    requirements:
      database_endpoint: [ app, database ]

node_templates:
  app:
    type: example.SomeApp
    properties:
      # properties omitted for brevity
    capabilities:
      message_receiver:
        properties:
          service_ip: { get_input: mq_service_ip }
          # other properties omitted for brevity
    requirements:
      - database:
          # details omitted for brevity
      - host: webserv

  webserv:
    type: toska.nodes.WebServer
    properties:
      # properties omitted for brevity
    capabilities:
      data_endpoint:

```

```

    properties:
      port_name: { get_input: receiver_port }
      # other properties omitted for brevity
    requirements:
      - host: server

    server:
      type: toska.nodes.Compute
      # details omitted for brevity

    outputs:
      receiver_ip:
        description: private IP address of the message receiver application
        value: { get_attribute: [ server, private_address ] }
      receiver_port:
        description: Port of the message receiver endpoint
        value: { get_attribute: [ app, app_endpoint, port ] }

```

## 585 2.12 Grouping node templates

586 In designing applications composed of several interdependent software components (or nodes) it is often  
 587 desirable to manage these components as a named group. This can provide an effective way of  
 588 associating policies (e.g., scaling, placement, security or other) that orchestration tools can apply to all  
 589 the components of group during deployment or during other lifecycle stages.

590 In many realistic scenarios it is desirable to include scaling capabilities into an application to be able to  
 591 react on load variations at runtime. The example below shows the definition of a scaling web server stack,  
 592 where a variable number of servers with apache installed on them can exist, depending on the load on  
 593 the servers.

594 *Example 20 - Grouping Node Templates for possible policy application*

```

tosca_definitions_version: toska_simple_yaml_1_0

description: Template for a scaling web server.

topology_template:
  inputs:
    # omitted here for brevity

  node_templates:
    apache:
      type: toska.nodes.WebServer.Apache
      properties:
        # Details omitted for brevity

```



```

requirements:
  - host: server

server:
  type: toska.nodes.Compute
  # details omitted for brevity

groups:
  webservers_group:
    type: toska.groups.Root
    members: [ apache, server ]

```

595 The example first of all uses the concept of grouping to express which components (node templates)  
 596 need to be scaled as a unit – i.e. the compute nodes and the software on-top of each compute node. This  
 597 is done by defining the **webservers\_group** in the **groups** section of the template and by adding both the  
 598 **apache** node template and the **server** node template as a member to the group.

599 Furthermore, a scaling policy is defined for the group to express that the group as a whole (i.e. pairs of  
 600 **server** node and the **apache** component installed on top) should scale up or down under certain  
 601 conditions.

602 In cases where no explicit binding between software components and their hosting compute resources is  
 603 defined in a template, but only requirements are defined as has been shown in section 2.9, a provider  
 604 could decide to place software components on the same host if their hosting requirements match, or to  
 605 place them onto different hosts.

606 It is often desired, though, to influence placement at deployment time to make sure components get  
 607 collocation or anti-collocated. This can be expressed via grouping and policies as shown in the example  
 608 below.

609 *Example 21 - Grouping nodes for anti-collocation policy application*

```

tosca_definitions_version: toska_simple_yaml_1_0

description: Template hosting requirements and placement policy.

topology_template:
  inputs:
    # omitted here for brevity

  node_templates:
    wordpress_server:
      type: toska.nodes.WebServer
      properties:
        # omitted here for brevity
      requirements:
        - host:

```

```

# Find a Compute node that fulfills these additional filter reqs.
node_filter:
  capabilities:
    - host:
      properties:
        - mem_size: { greater_or_equal: 512 MB }
        - disk_size: { greater_or_equal: 2 GB }
    - os:
      properties:
        - architecture: x86_64
        - type: linux

mysql:
  type: tosca.nodes.DBMS.MySQL
  properties:
    # omitted here for brevity
  requirements:
    - host:
      node: tosca.nodes.Compute
      node_filter:
        capabilities:
          - host:
            properties:
              - disk_size: { greater_or_equal: 1 GB }
          - os:
            properties:
              - architecture: x86_64
              - type: linux

groups:
  my_co_location_group:
    type: tosca.groups.Root
    members: [ wordpress_server, mysql ]

policies:
  - my_anti_collocation_policy:
    type: my.policies.anticollocateion
    targets: [ my_co_location_group ]
    # For this example, specific policy definitions are considered
    # domain specific and are not included here

```

610 In the example above, both software components **wordpress\_server** and **mysql** have similar hosting  
611 requirements. Therefore, a provider could decide to put both on the same server as long as both their  
612 respective requirements can be fulfilled. By defining a group of the two components and attaching an anti-  
613 collocation policy to the group it can be made sure, though, that both components are put onto different  
614 hosts at deployment time.

## 615 **2.13 Using YAML Macros to simplify templates**

616 The YAML 1.2 specification allows for defining of [aliases](#), which allow for authoring a block of YAML (or  
617 node) once and indicating it is an “anchor” and then referencing it elsewhere in the same document as an  
618 “alias”. Effectively, YAML parsers treat this as a “macro” and copy the anchor block’s code to wherever it  
619 is referenced. Use of this feature is especially helpful when authoring TOSCA Service Templates where  
620 similar definitions and property settings may be repeated multiple times when describing a multi-tier  
621 application.

622

623 For example, an application that has a web server and database (i.e., a two-tier application) may be  
624 described using two **Compute** nodes (one to host the web server and another to host the database). The  
625 author may want both Compute nodes to be instantiated with similar properties such as operating system,  
626 distribution, version, etc.

627 To accomplish this, the author would describe the reusable properties using a named anchor in the  
628 “**dsl\_definitions**” section of the TOSCA Service Template and reference the anchor name as an alias  
629 in any **Compute** node templates where these properties may need to be reused. For example:

630 *Example 22 - Using YAML anchors in TOSCA templates*

```
tosca_definitions_version: tosca_simple_yaml_1_0

description: >
  TOSCA simple profile that just defines a YAML macro for commonly reused Compute
  properties.

dsl_definitions:
  my_compute_node_props: &my_compute_node_props
    disk_size: 10 GB
    num_cpus: 1
    mem_size: 2 GB

topology_template:
  node_templates:
    my_server:
      type: Compute
      capabilities:
        - host:
            properties: *my_compute_node_props

    my_database:
      type: Compute
```

```
capabilities:
  - host:
    properties: *my_compute_node_props
```

## 631 2.14 Passing information as inputs to Nodes and Relationships

632 It is possible for type and template authors to declare input variables within an **inputs** block on interfaces  
633 to nodes or relationships in order to pass along information needed by their operations (scripts). These  
634 declarations can be scoped such as to make these variable values available to all operations on a node  
635 or relationships interfaces or to individual operations. TOSCA orchestrators will make these values  
636 available as environment variables within the execution environments in which the scripts associated with  
637 lifecycle operations are run.

### 638 2.14.1 Example: declaring input variables for all operations on a single 639 interface

```
node_templates:
  wordpress:
    type: tosca.nodes.WebApplication.WordPress
    requirements:
      ...
      - database_endpoint: mysql_database
    interfaces:
      Standard:
        inputs:
          wp_db_port: { get_property: [ SELF, database_endpoint, port ] }
```

### 640 2.14.2 Example: declaring input variables for a single operation

```
node_templates:
  wordpress:
    type: tosca.nodes.WebApplication.WordPress
    requirements:
      ...
      - database_endpoint: mysql_database
    interfaces:
      Standard:
        create: wordpress_install.sh
        configure:
          implementation: wordpress_configure.sh
        inputs:
          wp_db_port: { get_property: [ SELF, database_endpoint, port ] }
```

641 In the case where an input variable name is defined at more than one scope within the same interfaces  
642 section of a node or template definition, the lowest (or innermost) scoped declaration would override  
643 those declared at higher (or more outer) levels of the definition.

### 644 2.14.3 Example: setting output variables to an attribute

```
node_templates:  
  frontend:  
    type: MyTypes.SomeNodeType  
    attributes:  
      url: { get_operation_output: [ SELF, Standard, create, generated_url ] }  
    interfaces:  
      Standard:  
        create:  
          implementation: scripts/frontend/create.sh
```

645  
646 In this example, the Standard create operation exposes / exports an environment variable named  
647 “generated\_url” attribute which will be assigned to the WordPress node’s url attribute.

### 648 2.14.4 Example: passing output variables between operations

```
node_templates:  
  frontend:  
    type: MyTypes.SomeNodeType  
    interfaces:  
      Standard:  
        create:  
          implementation: scripts/frontend/create.sh  
        configure:  
          implementation: scripts/frontend/configure.sh  
          inputs:  
            data_dir: { get_operation_output: [ SELF, Standard, create, data_dir  
] }
```

649 In this example, the Standard lifecycle’s create operation exposes / exports an environment variable  
650 named “data\_dir” which will be passed as an input to the Standard lifecycle’s configure operation.

## 651 2.15 Topology Template Model versus Instance Model

652 A TOSCA service template contains a **topology template**, which models the components of an  
653 application, their relationships and dependencies (a.k.a., a topology model) that get interpreted and  
654 instantiated by TOSCA Orchestrators. The actual node and relationship instances that are created  
655 represent a set of resources distinct from the template itself, called a **topology instance (model)**. The  
656 direction of this specification is to provide access to the instances of these resources for management  
657 and operational control by external administrators. This model can also be accessed by an orchestration  
658 engine during deployment – i.e. during the actual process of instantiating the template in an incremental  
659 fashion. That is, the orchestrator can choose the order of resources to instantiate (i.e., establishing a  
660 partial set of node and relationship instances) and have the ability, as they are being created, to access  
661 them in order to facilitate instantiating the remaining resources of the complete topology template.

## 662 2.16 Using attributes implicitly reflected from properties

663 Most entity types in TOSCA (e.g., Node, Relationship, Capability Types, etc.) have [property definitions](#),  
664 which allow template authors to set the values for as inputs when these entities are instantiated by an  
665 orchestrator. These property values are considered to reflect the desired state of the entity by the author.  
666 Once instantiated, the actual values for these properties on the realized (instantiated) entity are  
667 obtainable via attributes on the entity with the same name as the corresponding property.

668 In other words, TOSCA orchestrators will automatically reflect (i.e., make available) any property defined  
669 on an entity making it available as an attribute of the entity with the same name as the property.

670

671 Use of this feature is shown in the example below where a source node named `my_client`, of type  
672 `ClientNode`, requires a connection to another node named `my_server` of type `ServerNode`. As you can  
673 see, the `ServerNode` type defines a property named `notification_port` which defines a dedicated port  
674 number which instances of `my_client` may use to post asynchronous notifications to it during runtime. In  
675 this case, the TOSCA Simple Profile assures that the `notification_port` property is implicitly reflected  
676 as an attribute in the `my_server` node (also with the name `notification_port`) when its node template  
677 is instantiated.

678

679 *Example 23 - Properties reflected as attributes*

```
tosca_definitions_version: tosca_simple_yaml_1_0

description: >
  TOSCA simple profile that shows how the (notification_port) property is
  reflected as an attribute and can be referenced elsewhere.

node_types:
  ServerNode:
    derived_from: SoftwareComponent
    properties:
      notification_port:
        type: integer
    capabilities:
      # omitted here for brevity

  ClientNode:
    derived_from: SoftwareComponent
    properties:
      # omitted here for brevity
    requirements:
      - server:
          capability: Endpoint
          node: ServerNode
          relationship: ConnectsTo
```

```

topology_template:
  node_templates:

    my_server:
      type: ServerNode
      properties:
        notification_port: 8000

    my_client:
      type: ClientNode
      requirements:
        - server:
            node: my_server
            relationship: my_connection

  relationship_templates:
    my_connection:
      type: ConnectsTo
      interfaces:
        Configure:
          inputs:
            targ_notify_port: { get_attribute: [ TARGET, notification_port ] }
            # other operation definitions omitted here for brevity

```

680

681 Specifically, the above example shows that the **ClientNode** type needs the **notification\_port** value  
 682 anytime a node of **ServerType** is connected to it using the **ConnectsTo** relationship in order to make it  
 683 available to its **Configure** operations (scripts). It does this by using the **get\_attribute** function to  
 684 retrieve the **notification\_port** attribute from the **TARGET** node of the **ConnectsTo** relationship (which is  
 685 a node of type **ServerNode**) and assigning it to an environment variable named **targ\_notify\_port**.

686

687 It should be noted that the actual port value of the **notification\_port** attribute may or may not be the  
 688 value **8000** as requested on the property; therefore, any node that is dependent on knowing its actual  
 689 “runtime” value would use the **get\_attribute** function instead of the **get\_property** function.

690

## 3 TOSCA Simple Profile definitions in YAML

691 Except for the examples, this section is **normative** and describes all of the YAML grammar, definitions  
692 and block structure for all keys and mappings that are defined for the TOSCA Version 1.2 Simple Profile  
693 specification that are needed to describe a TOSCA Service Template (in YAML).

### 3.1 TOSCA Namespace URI and alias

695 The following TOSCA Namespace URI alias and TOSCA Namespace Alias are reserved values which  
696 SHALL be used when identifying the TOSCA Simple Profile version 1.2 specification.

Namespace Alias	Namespace URI	Specification Description
tosca_simple_yaml_1_2	http://docs.oasis-open.org/tosca/ns/simple/yaml/1.2	The TOSCA Simple Profile v1.2 (YAML) target namespace and namespace alias.

#### 3.1.1 TOSCA Namespace prefix

698 The following TOSCA Namespace prefix is a reserved value and SHALL be used to reference the default  
699 TOSCA Namespace URI as declared in TOSCA Service Templates.

Namespace Prefix	Specification Description
tosca	The reserved TOSCA Simple Profile Specification prefix that can be associated with the default TOSCA Namespace URI

#### 3.1.2 TOSCA Namespacing in TOSCA Service Templates

701 In the TOSCA Simple Profile, TOSCA Service Templates MUST always have, as the first line of YAML,  
702 the keyword "**tosca\_definitions\_version**" with an associated TOSCA Namespace Alias value. This  
703 single line accomplishes the following:

- 704 1. Establishes the TOSCA Simple Profile Specification version whose grammar MUST be used to  
705 parse and interpret the contents for the remainder of the TOSCA Service Template.
- 706 2. Establishes the default TOSCA Namespace URI and Namespace Prefix for all types found in the  
707 document that are not explicitly namespaced.
- 708 3. Automatically imports (without the use of an explicit import statement) the normative type  
709 definitions (e.g., Node, Relationship, Capability, Artifact, etc.) that are associated with the TOSCA  
710 Simple Profile Specification the TOSCA Namespace Alias value identifies.
- 711 4. Associates the TOSCA Namespace URI and Namespace Prefix to the automatically imported  
712 TOSCA type definitions.

#### 3.1.3 Rules to avoid namespace collisions

714 TOSCA Simple Profiles allows template authors to declare their own types and templates and assign  
715 them simple names with no apparent namespaces. Since TOSCA Service Templates can import other  
716 service templates to introduce new types and topologies of templates that can be used to provide  
717 concrete implementations (or substitute) for abstract nodes. Rules are needed so that TOSCA  
718 Orchestrators know how to avoid collisions and apply their own namespaces when import and nesting  
719 occur.

##### 3.1.3.1 Additional Requirements

- 721 • The URI value "<http://docs.oasis-open.org/tosca>", as well as all (path) extensions to it, SHALL be  
722 reserved for TOSCA approved specifications and work. That means Service Templates that do



- 723 not originate from a TOSCA approved work product MUST NOT use it, in any form, when  
724 declaring a (default) Namespace.
- 725 • Since TOSCA Service Templates can import (or substitute in) other Service Templates, TOSCA  
726 Orchestrators and tooling will encounter the “**tosca\_definitions\_version**” statement for each  
727 imported template. In these cases, the following additional requirements apply:
    - 728 ○ Imported type definitions with the same Namespace URI, local name and version SHALL  
729 be equivalent.
    - 730 ○ If different values of the “**tosca\_definitions\_version**” are encountered, their  
731 corresponding type definitions MUST be uniquely identifiable using their corresponding  
732 Namespace URI using a different Namespace prefix.
  - 733 • Duplicate local names (i.e., within the same Service Template SHALL be considered an error.  
734 These include, but are not limited to duplicate names found for the following definitions:
    - 735 ○ Repositories (repositories)
    - 736 ○ Data Types (data\_types)
    - 737 ○ Node Types (node\_types)
    - 738 ○ Relationship Types (relationship\_types)
    - 739 ○ Capability Types (capability\_types)
    - 740 ○ Artifact Types (artifact\_types)
    - 741 ○ Interface Types (interface\_types)
  - 742 • Duplicate Template names within a Service Template’s Topology Template SHALL be considered  
743 an error. These include, but are not limited to duplicate names found for the following template  
744 types:
    - 745 ○ Node Templates (node\_templates)
    - 746 ○ Relationship Templates (relationship\_templates)
    - 747 ○ Inputs (inputs)
    - 748 ○ Outputs (outputs)
  - 749 • Duplicate names for the following keynames within Types or Templates SHALL be considered an  
750 error. These include, but are not limited to duplicate names found for the following keynames:
    - 751 ○ Properties (properties)
    - 752 ○ Attributes (attributes)
    - 753 ○ Artifacts (artifacts)
    - 754 ○ Requirements (requirements)
    - 755 ○ Capabilities (capabilities)
    - 756 ○ Interfaces (interfaces)
    - 757 ○ Policies (policies)
    - 758 ○ Groups (groups)

## 759 3.2 Using Namespaces

760 As of TOSCA version 1.2, Service template authors may declare a namespace within a Service Template  
761 that would be used as the default namespace for any types (e.g., Node Type, Relationship Type, Data  
762 Type, etc.) defined within the same Service template.

763

764 Specifically, a Service Template’s namespace declaration’s URI would be used to form a unique, fully  
765 qualified Type name when combined with the locally defined, unqualified name of any Type in the same  
766 Service Template. The resultant, fully qualified Type name would be used by TOSCA Orchestrators,  
767 Processors and tooling when that Service Template was imported into another Service Template to avoid  
768 Type name collision.

769

770 **3.2.1.1.1 Example – Importing a Service Template and Namespaces**

771 For example, let say we have two Service Templates, A and B, both of which define Types and a  
772 Namespace. Service Template B contains a Node Type definition for “MyNode” and declares its (default)  
773 Namespace to be “http://companyB.com/service/namespace”:

774 **Service Template B**

775

```
tosca_definitions_version: toska_simple_yaml_1_2
description: Service Template B
namespace: http://companyB.com/service/namespace/

node_types:
  MyNode:
    derived_from: SoftwareComponent
    properties:
      # omitted here for brevity
    capabilities:
      # omitted here for brevity
```

776

777 Service Template A has its own, completely different, Node Type definition also named “MyNode”.

778

779 **Service Template A**

780

```
tosca_definitions_version: toska_simple_yaml_1_2
description: Service Template A
namespace: http://companyA.com/product/ns/

imports:
  - file: csar/templates/ServiceTemplateB.yaml
    namespace_prefix: templateB

node_types:
  MyNode:
    derived_from: Root
    properties:
      # omitted here for brevity
    capabilities:
      # omitted here for brevity
```

781 As you can see, Service Template A also “imports” Service Template B (i.e., “ServiceTemplateB.yaml”)   
782 bringing in its Type definitions to the global namespace using the Namespace URI declared in Service   
783 Template B to fully qualify all of its imported types.

784

785 In addition, the import includes a “namespace\_prefix” value (i.e., “templateB” ), that can be used to qualify  
786 and disambiguate any Type reference from from Service Template B within Service Template A. This  
787 prefix is effectively the local alias for the corresponding Namespace URI declared within Service  
788 Template B (i.e., “http://companyB.com/service/namespace/”).

789

790 To illustrate conceptually what a TOSCA Orchestrator, for example, would track for their global  
791 namespace upon processing Service Template A (and by import Service Template B) would be a list of  
792 global Namespace URIs and their associated Namespace prefixes, as well as a list of fully qualified Type  
793 names that comprises the overall global namespace.

### 794 Conceptual Global Namespace URI and Namespace Prefix tracking

795

Entry #	Fully Qualified URI	Namespace Prefix	Added by Key (Source file)
1	http://open.org/tosca/ns/simple/yaml/1.2/	tosca	<ul style="list-style-type: none"> <li>•tosca_definitions_version:               <ul style="list-style-type: none"> <li>- from Service Template A</li> </ul> </li> </ul>
2	http://companyA.com/product/ns/	<None>	<ul style="list-style-type: none"> <li>•namespace:               <ul style="list-style-type: none"> <li>- from Service Template A</li> </ul> </li> </ul>
3	http://companyB.com/service/namespace/	templateB	<ul style="list-style-type: none"> <li>•namespace:               <ul style="list-style-type: none"> <li>- from Service Template B</li> </ul> </li> <li>•namespace_prefix:               <ul style="list-style-type: none"> <li>- from Service Template A, during import</li> </ul> </li> </ul>

796

797 In the above table,

- 798 • **Entry 1:** is an entry for the default TOSCA namespace, which is required to exist for it to be a  
799 valid Service template. It is established by the “tosca\_definitions\_version” key’s value. By  
800 default, it also gets assigned the “tosca” Namespace prefix.
- 801 • **Entry 2:** is the entry for the local default namespace for Service Template A as declared by the  
802 “namespace” key.
  - 803 ○ *Note that no Namespace prefix is needed; any locally defined types that are not qualified*  
804 *(i.e., not a full URI or using a Namespace Prefix) will default to this namespace if not*  
805 *found first in the TOSCA namespace.*
- 806 • **Entry 3:** is the entry for default Namespace URI for any type imported from Service Template B.  
807 The author of Service Template A has assigned the local Namespace Prefix “template” that can  
808 be used to qualify reference to any Type from Service Template B.

809

810 As per TOSCA specification, any Type, that is not qualified with the ‘tosca’ prefix or full URI name, should  
811 be first resolved by its unqualified name within the TOSCA namespace. If it not found there, then it may  
812 be resolved within the local Service Template’s default namespace.

813

### 814 Conceptual Global Namespace and Type tracking

815

Entry#	Owning Namespace URI	Full Name	Short Name	Type Classification
1	http://open.org/tosca/ns/simple/yaml/1.2/	tosca.nodes.Compute	Compute	node
2		tosca.nodes.SoftwareComponent	SoftwareComponent	

3		tosca.relationships.ConnectsTo	ConnectsTo	relationship
...				
100	http://companyA.com/product/ns/	N/A	MyNode	node
...	...			
200	http://companyB.com/service/namespace/	N/A	MyNode	node
...				

816

817 In the above table,

- 818 • Entry 1, is an example of one of the TOSCA standard Node Types (i.e., “Compute”) that is
- 819 brought into the global namespace via the “tosca\_definitions\_version” key.
- 820 ○ It also has two forms, full and short that are unique to TOSCA types for historical
- 821 reasons. Reference to a TOSCA type by either its unqualified short or full names is
- 822 viewed as equivalent as a reference to the same fully qualified Type name (i.e., its full
- 823 URI).
- 824 ○ In this example, use of either “tosca.nodes.Compute” or “Compute” (i.e., an unqualified
- 825 full and short name Type) in a Service Template would be treated as its fully qualified
- 826 URI equivalent of:
- 827 ■ “<http://docs.oasis-open.org/tosca/ns/simple/yaml/1.2/tosca.nodes.Compute>”.
- 828 • Entry 2, is an example of a standard TOSCA Relationship Type
- 829 • Entry 100, contains the unique Type identifier for the Node Type “MyNode” from Service
- 830 Template A.
- 831 • Entry 200, contains the unique Type identifier for the Node Type “MyNode” from Service
- 832 Template B.

833

834 As you can see, although both templates defined a NodeType with an unqualified name of “MyNode”,

835 the TOSCA Orchestrator, processor or tool tracks them by their unique fully qualified Type Name

836 (URI).

837

838 The classification column is included as an example on how to logically differentiate a “Compute”

839 Node Type and “Compute” capability type if the table would be used to “search” for a match based

840 upon context in a Service Template.

841

842 For example, if the short name “Compute” were used in a template on a Requirements clause, then

843 the matching type would not be the Compute Node Type, but instead the Compute Capability Type

844 based upon the Requirement clause being the context for Type reference.

### 845 3.3 Parameter and property types

846 This clause describes the primitive types that are used for declaring normative properties, parameters

847 and grammar elements throughout this specification.

#### 848 3.3.1 Referenced YAML Types

849 Many of the types we use in this profile are built-in types from the [YAML 1.2 specification](#) (i.e., those

850 identified by the “tag:yaml.org,2002” version tag) [YAML-1.2].

851 The following table declares the valid YAML type URIs and aliases that SHALL be used when possible

852 when defining parameters or properties within TOSCA Service Templates using this specification:

Valid aliases	Type URI
string	tag:yaml.org,2002:str (default)
integer	tag:yaml.org,2002:int
float	tag:yaml.org,2002:float
boolean	tag:yaml.org,2002:bool (i.e., a value either 'true' or 'false')
timestamp	<a href="#">tag:yaml.org,2002:timestamp</a> [YAML-TS-1.1]
null	tag:yaml.org,2002:null

### 853 3.3.1.1 Notes

- 854
- The “string” type is the default type when not specified on a parameter or property declaration.
- 855
- While YAML supports further type aliases, such as “str” for “string”, the TOSCA Simple Profile
- 856
- specification promotes the fully expressed alias name for clarity.

### 857 3.3.2 TOSCA version

858 TOSCA supports the concept of “reuse” of type definitions, as well as template definitions which could be  
859 version and change over time. It is important to provide a reliable, normative means to represent a  
860 version string which enables the comparison and management of types and templates over time.  
861 Therefore, the TOSCA TC intends to provide a normative version type (string) for this purpose in future  
862 Working Drafts of this specification.

<b>Shorthand Name</b>	version
<b>Type Qualified Name</b>	tosca:version

#### 863 3.3.2.1 Grammar

864 TOSCA version strings have the following grammar:

```
<major_version>.<minor_version>[.<fix_version>[.<qualifier>[-<build_version>] ] ]
```

865 In the above grammar, the pseudo values that appear in angle brackets have the following meaning:

- 866
- **major\_version**: is a required integer value greater than or equal to 0 (zero)
- 867
- **minor\_version**: is a required integer value greater than or equal to 0 (zero).
- 868
- **fix\_version**: is an optional integer value greater than or equal to 0 (zero).
- 869
- **qualifier**: is an optional string that indicates a named, pre-release version of the associated
- 870
- code that has been derived from the version of the code identified by the combination
- 871
- major\_version**, **minor\_version** and **fix\_version** numbers.
- 872
- **build\_version**: is an optional integer value greater than or equal to 0 (zero) that can be used to
- 873
- further qualify different build versions of the code that has the same **qualifer\_string**.

#### 874 3.3.2.2 Version Comparison

- 875
- When comparing TOSCA versions, all component versions (i.e., *major*, *minor* and *fix*) are
- 876
- compared in sequence from left to right.
- 877
- TOSCA versions that include the optional qualifier are considered older than those without a
- 878
- qualifier.

- 879 • TOSCA versions with the same major, minor, and fix versions and have the same qualifier string,  
880 but with different build versions can be compared based upon the build version.
- 881 • Qualifier strings are considered domain-specific. Therefore, this specification makes no  
882 recommendation on how to compare TOSCA versions with the same major, minor and fix  
883 versions, but with different qualifiers strings and simply considers them different named branches  
884 derived from the same code.

### 885 3.3.2.3 Examples

886 Examples of valid TOSCA version strings:

```
# basic version strings
6.1
2.0.1

# version string with optional qualifier
3.1.0.beta

# version string with optional qualifier and build version
1.0.0.alpha-10
```

### 887 3.3.2.4 Notes

- 888 • [\[Maven-Version\]](#) The TOSCA version type is compatible with the Apache Maven versioning  
889 policy.

### 890 3.3.2.5 Additional Requirements

- 891 • A version value of zero (i.e., '0', '0.0', or '0.0.0') SHALL indicate there no version provided.
- 892 • A version value of zero used with any qualifiers SHALL NOT be valid.

## 893 3.3.3 TOSCA range type

894 The range type can be used to define numeric ranges with a lower and upper boundary. For example, this  
895 allows for specifying a range of ports to be opened in a firewall.

<b>Shorthand Name</b>	range
<b>Type Qualified Name</b>	tosca:range

### 896 3.3.3.1 Grammar

897 TOSCA range values have the following grammar:

```
[<lower_bound>, <upper_bound>]
```

898 In the above grammar, the pseudo values that appear in angle brackets have the following meaning:

- 899 • **lower\_bound**: is a required integer value that denotes the lower boundary of the range.
- 900 • **upper\_bound**: is a required integer value that denotes the upper boundary of the range. This  
901 value MUST be greater than **lower\_bound**.

### 902 3.3.3.2 Keywords

903 The following Keywords may be used in the TOSCA range type:

Keyword	Applicable Types	Description
UNBOUNDED	scalar	Used to represent an unbounded upper bounds (positive) value in a set for a scalar type.

### 904 3.3.3.3 Examples

905 Example of a node template property with a range value:

```
# numeric range between 1 and 100
a_range_property: [ 1, 100 ]

# a property that has allows any number 0 or greater
num_connections: [ 0, UNBOUNDED ]
```

906

### 907 3.3.4 TOSCA list type

908 The list type allows for specifying multiple values for a parameter of property. For example, if an  
909 application allows for being configured to listen on multiple ports, a list of ports could be configured using  
910 the list data type.

911 Note that entries in a list for one property or parameter must be of the same type. The type (for simple  
912 entries) or schema (for complex entries) is defined by the **entry\_schema** attribute of the respective  
913 [property definition](#), [attribute definitions](#), or input or output [parameter definitions](#).

Shorthand Name	list
Type Qualified Name	tosca:list

### 914 3.3.4.1 Grammar

915 TOSCA lists are essentially normal YAML lists with the following grammars:

#### 916 3.3.4.1.1 Square bracket notation

```
[ <list_entry_1>, <list_entry_2>, ... ]
```

#### 917 3.3.4.1.2 Bulleted (sequenced) list notation

```
- <list_entry_1>
- ...
- <list_entry_n>
```

918 In the above grammars, the pseudo values that appear in angle brackets have the following meaning:

- 919
- **<list\_entry\_\*>**: represents one entry of the list.

## 920 3.3.4.2 Declaration Examples

### 921 3.3.4.2.1 List declaration using a simple type

922 The following example shows a list declaration with an entry schema based upon a simple integer type  
923 (which has additional constraints):

```
<some_entity>:
  ...
  properties:
    listen_ports:
      type: list
      entry_schema:
        description: listen port entry (simple integer type)
        type: integer
        constraints:
          - max_length: 128
```

### 924 3.3.4.2.2 List declaration using a complex type

925 The following example shows a list declaration with an entry schema based upon a complex type:

```
<some_entity>:
  ...
  properties:
    products:
      type: list
      entry_schema:
        description: Product information entry (complex type) defined elsewhere
        type: ProductInfo
```

## 926 3.3.4.3 Definition Examples

927 These examples show two notation options for defining lists:

- 928
- 929 • A single-line option which is useful for only short lists with simple entries.
  - 930 • A multi-line option where each list entry is on a separate line; this option is typically useful or more readable if there is a large number of entries, or if the entries are complex.

### 931 3.3.4.3.1 Square bracket notation

```
listen_ports: [ 80, 8080 ]
```

### 932 3.3.4.3.2 Bulleted list notation

```
listen_ports:
  - 80
  - 8080
```



### 933 3.3.5 TOSCA map type

934 The map type allows for specifying multiple values for a parameter of property as a map. In contrast to  
935 the list type, where each entry can only be addressed by its index in the list, entries in a map are named  
936 elements that can be addressed by their keys.

937 Note that entries in a map for one property or parameter must be of the same type. The type (for simple  
938 entries) or schema (for complex entries) is defined by the **entry\_schema** attribute of the respective  
939 [property definition](#), [attribute definition](#), or input or output [parameter definition](#).

<b>Shorthand Name</b>	map
<b>Type Qualified Name</b>	tosca:map

#### 940 3.3.5.1 Grammar

941 TOSCA maps are normal YAML dictionaries with following grammar:

##### 942 3.3.5.1.1 Single-line grammar

```
{ <entry_key_1>: <entry_value_1>, ..., <entry_key_n>: <entry_value_n> }  
...  
<entry_key_n>: <entry_value_n>
```

##### 943 3.3.5.1.2 Multi-line grammar

```
<entry_key_1>: <entry_value_1>  
...  
<entry_key_n>: <entry_value_n>
```

944 In the above grammars, the pseudo values that appear in angle brackets have the following meaning:

- 945 • **entry\_key\_\***: is the required key for an entry in the map
- 946 • **entry\_value\_\***: is the value of the respective entry in the map

#### 947 3.3.5.2 Declaration Examples

##### 948 3.3.5.2.1 Map declaration using a simple type

949 The following example shows a map with an entry schema definition based upon an existing string type  
950 (which has additional constraints):

```
<some_entity>:  
  ...  
  properties:  
    emails:  
      type: map  
      entry_schema:  
        description: basic email address  
        type: string  
        constraints:
```

```
- max_length: 128
```

### 951 3.3.5.2.2 Map declaration using a complex type

952 The following example shows a map with an entry schema definition for contact information:

```
<some_entity>:
  ...
  properties:
    contacts:
      type: map
      entry_schema:
        description: simple contact information
        type: ContactInfo
```

### 953 3.3.5.3 Definition Examples

954 These examples show two notation options for defining maps:

- 955
- A single-line option which is useful for only short maps with simple entries.
  - A multi-line option where each map entry is on a separate line; this option is typically useful or more readable if there is a large number of entries, or if the entries are complex.
- 956
- 957

#### 958 3.3.5.3.1 Single-line notation

```
# notation option for shorter maps
user_name_to_id_map: { user1: 1001, user2: 1002 }
```

#### 959 3.3.5.3.2 Multi-line notation

```
# notation for longer maps
user_name_to_id_map:
  user1: 1001
  user2: 1002
```

### 960 3.3.6 TOSCA scalar-unit type

961 The scalar-unit type can be used to define scalar values along with a unit from the list of recognized units  
962 provided below.

#### 963 3.3.6.1 Grammar

964 TOSCA scalar-unit typed values have the following grammar:

```
<scalar> <unit>
```

965 In the above grammar, the pseudo values that appear in angle brackets have the following meaning:

- 966
- **scalar**: is a required scalar value.
  - **unit**: is a required unit value. The unit value **MUST** be type-compatible with the scalar.
- 967

968 **3.3.6.2 Additional requirements**

- 969
- **Whitespace:** any number of spaces (including zero or none) **SHALL** be allowed between the **scalar** value and the **unit** value.
  - 970
  - 971 • It **SHALL** be considered an error if either the scalar or unit portion is missing on a property or
  - 972 attribute declaration derived from any scalar-unit type.
  - 973 • When performing constraint clause evaluation on values of the scalar-unit type, both the scalar
  - 974 value portion and unit value portion **SHALL** be compared together (i.e., both are treated as a
  - 975 single value). For example, if we have a property called **storage\_size**, which is of type scalar-
  - 976 unit, a valid range constraint would appear as follows:
  - 977
    - `storage_size: in_range [ 4 GB, 20 GB ]`

978 where **storage\_size**'s range would be evaluated using both the numeric and unit values

979 (combined together), in this case '4 GB' and '20 GB'.

980 **3.3.6.3 Concrete Types**

<b>Shorthand Names</b>	scalar-unit.size, scalar-unit.size
<b>Type Qualified Names</b>	tosca:scalar-unit.size, toasca:scalar-unit.time

- 981
- 982 The scalar-unit type grammar is abstract and has two recognized concrete types in TOSCA:
- 983 • **scalar-unit.size** – used to define properties that have scalar values measured in size units.
  - 984 • **scalar-unit.time** – used to define properties that have scalar values measured in size units.
  - 985 • **scalar-unit.frequency** – used to define properties that have scalar values measured in units per
  - 986 second.

987 These types and their allowed unit values are defined below.

988 **3.3.6.4 scalar-unit.size**

989 **3.3.6.4.1 Recognized Units**

Unit	Usage	Description
B	size	byte
kB	size	kilobyte (1000 bytes)
KiB	size	kibibytes (1024 bytes)
MB	size	megabyte (1000000 bytes)
MiB	size	mebibyte (1048576 bytes)
GB	size	gigabyte (1000000000 bytes)
GiB	size	gibibytes (1073741824 bytes)
TB	size	terabyte (1000000000000 bytes)
TiB	size	tebibyte (1099511627776 bytes)

990 **3.3.6.4.2 Examples**

```
# Storage size in Gigabytes
properties:
  storage_size: 10 GB
```

991 **3.3.6.4.3 Notes**

- 992 • The unit values recognized by TOSCA Simple Profile for size-type units are based upon a  
993 subset of those defined by GNU at  
994 [http://www.gnu.org/software/parted/manual/html\\_node/unit.html](http://www.gnu.org/software/parted/manual/html_node/unit.html), which is a non-normative  
995 reference to this specification.
- 996 • TOSCA treats these unit values as case-insensitive (e.g., a value of 'kB', 'KB' or 'kb' would be  
997 equivalent), but it is considered best practice to use the case of these units as prescribed by  
998 GNU.
- 999 • Some Cloud providers may not support byte-level granularity for storage size allocations. In  
1000 those cases, these values could be treated as desired sizes and actual allocations would be  
1001 based upon individual provider capabilities.

1002 **3.3.6.5 scalar-unit.time**

1003 **3.3.6.5.1 Recognized Units**

Unit	Usage	Description
d	time	days
h	time	hours
m	time	minutes
s	time	seconds
ms	time	milliseconds
us	time	microseconds
ns	time	nanoseconds

1004 **3.3.6.5.2 Examples**

```
# Response time in milliseconds
properties:
  response_time: 10 ms
```

1005 **3.3.6.5.3 Notes**

- 1006 • The unit values recognized by TOSCA Simple Profile for time-type units are based upon a subset  
1007 of those defined by International System of Units whose recognized abbreviations are defined  
1008 within the following reference:  
1009
  - o <http://www.ewh.ieee.org/soc/ias/pub-dept/abbreviation.pdf>

- 1010 ○ This document is a non-normative reference to this specification and intended for publications
- 1011 ○ or grammars enabled for Latin characters which are not accessible in typical programming
- 1012 ○ languages

### 1013 3.3.6.6 scalar-unit.frequency

#### 1014 3.3.6.6.1 Recognized Units

Unit	Usage	Description
Hz	frequency	Hertz, or Hz. equals one cycle per second.
kHz	frequency	Kilohertz, or kHz, equals to 1,000 Hertz
MHz	frequency	Megahertz, or MHz, equals to 1,000,000 Hertz or 1,000 kHz
GHz	frequency	Gigahertz, or GHz, equals to 1,000,000,000 Hertz, or 1,000,000 kHz, or 1,000 MHz.

#### 1015 3.3.6.6.2 Examples

```
# Processor raw clock rate
properties:
  clock_rate: 2.4 GHz
```

#### 1016 3.3.6.6.3 Notes

- 1017 • The value for Hertz (Hz) is the International Standard Unit (ISU) as described by the Bureau
- 1018 International des Poids et Mesures (BIPM) in the “*SI Brochure: The International System of Units*
- 1019 (*SI*) [8th edition, 2006; updated in 2014]”, <http://www.bipm.org/en/publications/si-brochure/>

## 1020 3.4 Normative values

### 1021 3.4.1 Node States

1022 As components (i.e., nodes) of TOSCA applications are deployed, instantiated and orchestrated over

1023 their lifecycle using normative lifecycle operations (see section 5.8 for normative lifecycle definitions) it is

1024 important define normative values for communicating the states of these components normatively

1025 between orchestration and workflow engines and any managers of these applications.

1026 The following table provides the list of recognized node states for TOSCA Simple Profile that would be set

1027 by the orchestrator to describe a node instance’s state:

Node State		
Value	Transitional	Description
initial	no	Node is not yet created. Node only exists as a template definition.
creating	yes	Node is transitioning from <b>initial</b> state to <b>created</b> state.
created	no	Node software has been installed.
configuring	yes	Node is transitioning from <b>created</b> state to <b>configured</b> state.

Node State		
Value	Transitional	Description
configured	no	Node has been configured prior to being started.
starting	yes	Node is transitioning from <b>configured</b> state to <b>started</b> state.
started	no	Node is started.
stopping	yes	Node is transitioning from its current state to a <b>configured</b> state.
deleting	yes	Node is transitioning from its current state to one where it is deleted and its state is no longer tracked by the instance model.
error	no	Node is in an error state.

## 1028 3.4.2 Relationship States

1029 Similar to the Node States described in the previous section, Relationships have state relative to their  
1030 (normative) lifecycle operations.

1031 The following table provides the list of recognized relationship states for TOSCA Simple Profile that would  
1032 be set by the orchestrator to describe a node instance's state:

Node State		
Value	Transitional	Description
initial	no	Relationship is not yet created. Relationship only exists as a template definition.

### 1033 3.4.2.1 Notes

- 1034 • Additional states may be defined in future versions of the TOSCA Simple Profile in YAML  
1035 specification.

## 1036 3.4.3 Directives

1037 There are currently no directive values defined for this version of the TOSCA Simple Profile.

## 1038 3.4.4 Network Name aliases

1039 The following are recognized values that may be used as aliases to reference types of networks within an  
1040 application model without knowing their actual name (or identifier) which may be assigned by the  
1041 underlying Cloud platform at runtime.

Alias value	Description
PRIVATE	An alias used to reference the first private network within a property or attribute of a Node or Capability which would be assigned to them by the underlying platform at runtime.  A private network contains IP addresses and ports typically used to listen for incoming traffic to an application or service from the Intranet and not accessible to the public internet.

Alias value	Description
PUBLIC	<p>An alias used to reference the first public network within a property or attribute of a Node or Capability which would be assigned to them by the underlying platform at runtime.</p> <p>A public network contains IP addresses and ports typically used to listen for incoming traffic to an application or service from the Internet.</p>

#### 1042 3.4.4.1 Usage

1043 These aliases would be used in the **tosca.capabilities.Endpoint** Capability type (and types derived  
1044 from it) within the **network\_name** field for template authors to use to indicate the type of network the  
1045 Endpoint is supposed to be assigned an IP address from.

### 1046 3.5 TOSCA Metamodel

1047 This section defines all modelable entities that comprise the TOSCA Version 1.0 Simple Profile  
1048 specification along with their keynames, grammar and requirements.

#### 1049 3.5.1 Required Keynames

1050 The TOSCA metamodel includes complex types (e.g., Node Types, Relationship Types, Capability Types,  
1051 Data Types, etc.) each of which include their own list of reserved keynames that are sometimes marked  
1052 as **required**. These types may be used to derive other types. These derived types (e.g., child types) do  
1053 not have to provide required keynames as long as they have been specified in the type they have been  
1054 derived from (i.e., their parent type).

### 1055 3.6 Reusable modeling definitions

#### 1056 3.6.1 Description definition

1057 This optional element provides a means include single or multiline descriptions within a TOSCA Simple  
1058 Profile template as a scalar string value.

##### 1059 3.6.1.1 Keyname

1060 The following keyname is used to provide a description within the TOSCA Simple Profile specification:

```
description
```

##### 1061 3.6.1.2 Grammar

1062 Description definitions have the following grammar:

```
description: <string>
```

##### 1063 3.6.1.3 Examples

1064 Simple descriptions are treated as a single literal that includes the entire contents of the line that  
1065 immediately follows the **description** key:

```
description: This is an example of a single line description (no folding).
```

1066 The YAML “folded” style may also be used for multi-line descriptions which “folds” line breaks as space  
1067 characters.

**description:** >

This is an example of a multi-line description using YAML. It permits for line breaks for easier readability...

if needed. However, (multiple) line breaks are folded into a single space character when processed into a single string value.

### 1068 3.6.1.4 Notes

- 1069 • Use of “folded” style is discouraged for the YAML string type apart from when used with the  
1070 **description** keyname.

## 1071 3.6.2 Metadata

1072 This optional element provides a means to include optional metadata as a map of strings.

### 1073 3.6.2.1 Keyname

1074 The following keyname is used to provide metadata within the TOSCA Simple Profile specification:

```
metadata
```

### 1075 3.6.2.2 Grammar

1076 Metadata definitions have the following grammar:

```
metadata:  
  map of <string>
```

### 1077 3.6.2.3 Examples

```
metadata:  
  foo1: bar1  
  foo2: bar2  
  ...
```

### 1078 3.6.2.4 Notes

- 1079 • Data provided within metadata, wherever it appears, MAY be ignored by TOSCA Orchestrators  
1080 and SHOULD NOT affect runtime behavior.

## 1081 3.6.3 Constraint clause

1082 A constraint clause defines an operation along with one or more compatible values that can be used to  
1083 define a constraint on a property or parameter’s allowed values when it is defined in a TOSCA Service  
1084 Template or one of its entities.

### 1085 3.6.3.1 Operator keynames

1086 The following is the list of recognized operators (keynames) when defining constraint clauses:



Operator	Type	Value Type	Description
equal	scalar	any	Constrains a property or parameter to a value equal to ('=') the value declared.
greater_than	scalar	comparable	Constrains a property or parameter to a value greater than ('>') the value declared.
greater_or_equal	scalar	comparable	Constrains a property or parameter to a value greater than or equal to ('>=') the value declared.
less_than	scalar	comparable	Constrains a property or parameter to a value less than ('<') the value declared.
less_or_equal	scalar	comparable	Constrains a property or parameter to a value less than or equal to ('<=') the value declared.
in_range	dual scalar	comparable, <a href="#">range</a>	Constrains a property or parameter to a value in range of (inclusive) the two values declared.  Note: subclasses or templates of types that declare a property with the <b>in_range</b> constraint MAY only further restrict the range specified by the parent type.
valid_values	list	any	Constrains a property or parameter to a value that is in the list of declared values.
length	scalar	<a href="#">string</a> , <a href="#">list</a> , <a href="#">map</a>	Constrains the property or parameter to a value of a given length.
min_length	scalar	<a href="#">string</a> , <a href="#">list</a> , <a href="#">map</a>	Constrains the property or parameter to a value to a minimum length.
max_length	scalar	<a href="#">string</a> , <a href="#">list</a> , <a href="#">map</a>	Constrains the property or parameter to a value to a maximum length.
pattern	regex	<a href="#">string</a>	Constrains the property or parameter to a value that is allowed by the provided regular expression.  <b>Note:</b> Future drafts of this specification will detail the use of regular expressions and reference an appropriate standardized grammar.
schema	string	string	Constrains the property or parameter to a value that is allowed by the referenced schema.

### 1087 3.6.3.1.1 Comparable value types

1088 In the Value Type column above, an entry of “comparable” includes [integer](#), [float](#), [timestamp](#), [string](#),  
1089 [version](#), and [scalar-unit](#) types while an entry of “any” refers to any type allowed in the TOSCA simple  
1090 profile in YAML.

### 1091 3.6.3.2 Schema Constraint purpose

1092 TOSCA recognizes that there are external data-interchange formats that are widely used within Cloud  
1093 service APIs and messaging (e.g., JSON, XML, etc.).

1094 The ‘schema’ Constraint was added so that, when TOSCA types utilize types from these externally  
1095 defined data (interchange) formats on Properties or Parameters, their corresponding Property definitions’  
1096 values can be optionally validated by TOSCA Orchestrators using the schema string provided on this  
1097 operator.

### 1098 3.6.3.3 Additional Requirements

- 1099 • If no operator is present for a simple scalar-value on a constraint clause, it **SHALL** be interpreted  
1100 as being equivalent to having the “**equal**” operator provided; however, the “**equal**” operator may  
1101 be used for clarity when expressing a constraint clause.
- 1102 • The “**length**” operator **SHALL** be interpreted mean “size” for set types (i.e., list, map, etc.).
- 1103 • Values provided by the operands (i.e., values and scalar values) **SHALL** be type-compatible with  
1104 their associated operations.
- 1105 • Future drafts of this specification will detail the use of regular expressions and reference an  
1106 appropriate standardized grammar.
- 1107 • The value for the keyname ‘schema’ **SHOULD** be a string that contains a valid external schema  
1108 definition that matches the corresponding Property definitions type.
  - 1109 ○ When a valid ‘schema’ value is provided on a Property definition, a TOSCA Orchestrator  
1110 **MAY** choose use the contained schema definition for validation.

### 1111 3.6.3.4 Grammar

1112 Constraint clauses have one of the following grammars:

```
# Scalar grammar
<operator>: <scalar_value>

# Dual scalar grammar
<operator>: [ <scalar_value_1>, <scalar_value_2> ]

# List grammar
<operator> [ <value_1>, <value_2>, ..., <value_n> ]

# Regular expression (regex) grammar
pattern: <regular_expression_value>

# Schema grammar
schema: <schema_definition>
```

1113 In the above grammar, the pseudo values that appear in angle brackets have the following meaning:

- 1114 • **operator**: represents a required operator from the specified list shown above (see section  
1115 3.6.3.1 “Operator keynames”).
- 1116 • **scalar\_value**, **scalar\_value\_\***: represents a required scalar (or atomic quantity) that can  
1117 hold only one value at a time. This will be a value of a primitive type, such as an integer or string  
1118 that is allowed by this specification.
- 1119 • **value\_\***: represents a required value of the operator that is not limited to scalars.
- 1120 • **regular\_expression\_value**: represents a regular expression (string) value.
- 1121 • **schema\_definition**: represents a schema definition as a string.

### 1122 3.6.3.5 Examples

1123 Constraint clauses used on parameter or property definitions:

```
# equal
```

```

equal: 2

# greater_than
greater_than: 1

# greater_or_equal
greater_or_equal: 2

# less_than
less_than: 5

# less_or_equal
less_or_equal: 4

# in_range
in_range: [ 1, 4 ]

# valid_values
valid_values: [ 1, 2, 4 ]
# specific length (in characters)
length: 32

# min_length (in characters)
min_length: 8

# max_length (in characters)
max_length: 64

# schema
schema: <
  {
    # Some schema syntax that matches corresponding property or parameter.
  }

```

### 1124 **3.6.4 Property Filter definition**

1125 A property filter definition defines criteria, using constraint clauses, for selection of a TOSCA entity based  
 1126 upon its property values.

#### 1127 **3.6.4.1 Grammar**

1128 Property filter definitions have one of the following grammars:

1129 **3.6.4.1.1 Short notation:**

1130 The following single-line grammar may be used when only a single constraint is needed on a property:

```
<property_name>: <property_constraint_clause>
```

1131 **3.6.4.1.2 Extended notation:**

1132 The following multi-line grammar may be used when multiple constraints are needed on a property:

```
<property_name>:  
- <property_constraint_clause_1>  
- ...  
- <property_constraint_clause_n>
```

1133 In the above grammars, the pseudo values that appear in angle brackets have the following meaning:

- 1134 • **property\_name**: represents the name of property that would be used to select a property  
1135 definition with the same name (**property\_name**) on a TOSCA entity (e.g., a Node Type, Node  
1136 Template, Capability Type, etc.).
- 1137 • **property\_constraint\_clause\_\***: represents constraint clause(s) that would be used to filter  
1138 entities based upon the named property's value(s).

1139 **3.6.4.2 Additional Requirements**

- 1140 • Property constraint clauses must be type compatible with the property definitions (of the same  
1141 name) as defined on the target TOSCA entity that the clause would be applied against.

1142 **3.6.5 Node Filter definition**

1143 A node filter definition defines criteria for selection of a TOSCA Node Template based upon the  
1144 template's property values, capabilities and capability properties.

1145 **3.6.5.1 Keynames**

1146 The following is the list of recognized keynames for a TOSCA node filter definition:

Keyname	Required	Type	Description
properties	no	list of <a href="#">property filter definition</a>	An optional sequenced list of property filters that would be used to select (filter) matching TOSCA entities (e.g., Node Template, Node Type, Capability Types, etc.) based upon their property definitions' values.
capabilities	no	list of capability names or <a href="#">capability type names</a>	An optional sequenced list of capability names or types that would be used to select (filter) matching TOSCA entities based upon their existence.

1147 **3.6.5.2 Additional filtering on named Capability properties**

1148 Capabilities used as filters often have their own sets of properties which also can be used to construct a  
1149 filter.

Keyname	Required	Type	Description
<capability name_or_type> name>: properties	no	list of <a href="#">property filter definitions</a>	An optional sequenced list of property filters that would be used to select (filter) matching TOSCA entities (e.g., Node Template, Node Type, Capability Types, etc.) based upon their capabilities' property definitions' values.

### 1150 3.6.5.3 Grammar

1151 Node filter definitions have following grammar:

```

<filter_name>:
  properties:
    - <property filter def 1>
    - ...
    - <property filter def n>
  capabilities:
    - <capability_name_or_type_1>:
      properties:
        - <cap 1 property filter def 1>
        - ...
        - <cap m property filter def n>
    - ...
    - <capability_name_or_type_n>:
      properties:
        - <cap 1 property filter def 1>
        - ...
        - <cap m property filter def n>

```

1152 In the above grammar, the pseudo values that appear in angle brackets have the following meaning:

- 1153 • **property\_filter\_def\_\***: represents a property filter definition that would be used to select
- 1154 (filter) matching TOSCA entities (e.g., Node Template, Node Type, Capability Types, etc.) based
- 1155 upon their property definitions' values.
- 1156 • **capability\_name\_or\_type\_\***: represents the type or name of a capability that would be used
- 1157 to select (filter) matching TOSCA entities based upon their existence.
- 1158 • **cap\_\*\_property\_def\_\***: represents a property filter definition that would be used to select
- 1159 (filter) matching TOSCA entities (e.g., Node Template, Node Type, Capability Types, etc.) based
- 1160 upon their capabilities' property definitions' values.

### 1161 3.6.5.4 Additional requirements

- 1162 • TOSCA orchestrators **SHALL** search for matching capabilities listed on a target filter by assuming
- 1163 the capability name is first a symbolic name and secondly it is a type name (in order to avoid
- 1164 namespace collisions).

### 1165 3.6.5.5 Example

1166 The following example is a filter that would be used to select a TOSCA [Compute](#) node based upon the

1167 values of its defined capabilities. Specifically, this filter would select Compute nodes that supported a

1168 specific range of CPUs (i.e., `num_cpus` value between 1 and 4) and memory size (i.e., `mem_size` of 2 or  
 1169 greater) from its declared “host” capability.  
 1170

```

my_node_template:
  # other details omitted for brevity
  requirements:
    - host:
      node_filter:
        capabilities:
          # My “host” Compute node needs these properties:
          - host:
              properties:
                - num_cpus: { in_range: [ 1, 4 ] }
                - mem_size: { greater_or_equal: 512 MB }
  
```

1171 **3.6.6 Repository definition**

1172 A repository definition defines a named external repository which contains deployment and  
 1173 implementation artifacts that are referenced within the TOSCA Service Template.

1174 **3.6.6.1 Keynames**

1175 The following is the list of recognized keynames for a TOSCA repository definition:

Keyname	Required	Type	Constraints	Description
description	no	<a href="#">description</a>	None	The optional description for the repository.
url	yes	<a href="#">string</a>	None	The required URL or network address used to access the repository.
credential	no	<a href="#">Credential</a>	None	The optional Credential used to authorize access to the repository.

1176 **3.6.6.2 Grammar**

1177 Repository definitions have one the following grammars:

1178 **3.6.6.2.1 Single-line grammar (no credential):**

```

<repository\_name>: <repository_address>
  
```

1179 **3.6.6.2.2 Multi-line grammar**

```

<repository\_name>:
  description: <repository\_description>
  url: <repository\_address>
  credential: <authorization\_credential>
  
```

1180 In the above grammar, the pseudo values that appear in angle brackets have the following meaning:

- 1181 • **repository\_name**: represents the required symbolic name of the repository as a [string](#).
- 1182 • **repository\_description**: contains an optional description of the repository.
- 1183 • **repository\_address**: represents the required URL of the repository as a string.
- 1184 • **authorization\_credential**: represents the optional credentials (e.g., user ID and password)
- 1185 used to authorize access to the repository.

### 1186 3.6.6.3 Example

1187 The following represents a repository definition:

```
repositories:
  my_code_repo:
    description: My project's code repository in GitHub
    url: https://github.com/my-project/
```

## 1188 3.6.7 Artifact definition

1189 An artifact definition defines a named, typed file that can be associated with Node Type or Node  
 1190 Template and used by orchestration engine to facilitate deployment and implementation of interface  
 1191 operations.

### 1192 3.6.7.1 Keynames

1193 The following is the list of recognized keynames for a TOSCA artifact definition when using the extended  
 1194 notation:

Keyname	Required	Type	Description
type	yes	<a href="#">string</a>	The required artifact type for the artifact definition.
file	yes	<a href="#">string</a>	The required URI string (relative or absolute) which can be used to locate the artifact's file.
repository	no	<a href="#">string</a>	The optional name of the repository definition which contains the location of the external repository that contains the artifact. The artifact is expected to be referenceable by its <b>file</b> URI within the repository.
description	no	<a href="#">description</a>	The optional description for the artifact definition.
deploy_path	no	<a href="#">string</a>	The file path the associated file would be deployed into within the target node's container.

### 1195 3.6.7.2 Grammar

1196 Artifact definitions have one of the following grammars:

#### 1197 3.6.7.2.1 Short notation

1198 The following single-line grammar may be used when the artifact's type and mime type can be inferred  
 1199 from the file URI:

```
<artifact name>: <artifact file URI>
```

#### 1200 3.6.7.2.2 Extended notation:

1201 The following multi-line grammar may be used when the artifact's definition's type and mime type need to  
 1202 be explicitly declared:

```

<artifact_name>:
  description: <artifact_description>
  type: <artifact_type_name>
  file: <artifact_file_URI>
  repository: <artifact_repository_name>
  deploy_path: <file_deployment_path>

```

1203 In the above grammars, the pseudo values that appear in angle brackets have the following meaning:

- 1204 • **artifact\_name**: represents the required symbolic name of the artifact as a **string**.
- 1205 • **artifact\_description**: represents the optional **description** for the artifact.
- 1206 • **artifact\_type\_name**: represents the required **artifact type** the artifact definition is based upon.
- 1207 • **artifact\_file\_URI**: represents the required **URI string (relative or absolute) which can be**
- 1208 **used to locate the artifact's file.**
- 1209 • **artifact\_repository\_name**: represents the optional name of the **repository definition** to use to
- 1210 retrieve the associated artifact (file) from.
- 1211 • **file\_deployment\_path**: represents the optional path the **artifact\_file\_URI** would be
- 1212 copied into within the target node's container.

### 1213 3.6.7.3 Example

1214 The following represents an artifact definition:

```
my_file_artifact: ../my_apps_files/operation_artifact.txt
```

### 1215 3.6.8 Import definition

1216 An import definition is used within a TOSCA Service Template to locate and uniquely name another  
 1217 TOSCA Service Template file which has type and template definitions to be imported (included) and  
 1218 referenced within another Service Template.

#### 1219 3.6.8.1 Keynames

1220 The following is the list of recognized keynames for a TOSCA import definition:

Keyname	Required	Type	Constraints	Description
file	yes	string	None	The required symbolic name for the imported file.
repository	no	string	None	The optional symbolic name of the repository definition where the imported file can be found as a string.
namespace_prefix	no	string	None	The optional namespace prefix (alias) that will be used to indicate the <b>namespace_uri</b> when forming a qualified name (i.e., QName) when referencing type definitions from the imported file.
namespace_uri	no	string	Deprecated	The optional, deprecated namespace URI to that will be applied to type definitions found within the imported file as a string.

#### 1221 3.6.8.2 Grammar

1222 Import definitions have one the following grammars:



### 1223 3.6.8.2.1 Single-line grammar:

```
imports:
- <URI_1>
- <URI_2>
```

### 1224 3.6.8.2.2 Multi-line grammar

```
imports:
- file: <file_URI>
  repository: <repository_name>
  namespace_uri: <definition_namespace_uri> # deprecated
  namespace_prefix: <definition_namespace_prefix>
```

1225 In the above grammar, the pseudo values that appear in angle brackets have the following meaning:

- 1226 • **file\_uri**: contains the required name (i.e., URI) of the file to be imported as a [string](#).
- 1227 • **repository\_name**: represents the optional symbolic name of the repository definition where the
- 1228 imported file can be found as a [string](#).
- 1229 • **namespace\_uri**: represents the optional namespace URI to that will be applied to type
- 1230 definitions found within the imported file as a [string](#).
- 1231 • **namespace\_prefix**: represents the optional namespace prefix (alias) that will be used to
- 1232 indicate the default namespace as declared in the imported Service Template when forming a
- 1233 qualified name (i.e., QName) when referencing type definitions from the imported file as a [string](#).

### 1234 3.6.8.2.3 Requirements

- 1235 • The imports key “namespace\_uri” is now deprecated. It was intended to be able to define a
- 1236 default namespace for any types that were defined within the Service Template being imported;
- 1237 however, with version 1.2, Service Templates MAY now declare their own default Namespace
- 1238 which SHALL be used in place of this key’s value.
  - 1239 ○ Please note that TOSCA Orchestrators and Processors MAY still use
  - 1240 the “namespace\_uri” value if provided, if the imported Service Template has no declared
  - 1241 default Namespace value. Regardless it is up to the TOSCA Orchestrator or Processor
  - 1242 to resolve Namespace collisions caused by imports as they see fit, for example, they may
  - 1243 treat it as an error or dynamically generate a unique namespace themselves on import.

### 1244 3.6.8.2.4 Import URI processing requirements

1245 TOSCA Orchestrators, Processors and tooling SHOULD treat the <file\_URI> of an import as follows:

- 1246 • **URI**: If the <file\_URI> is a known namespace URI (identifier), such as a well-known URI defined
- 1247 by a TOSCA specification, then it SHOULD cause the corresponding Type definitions to be
- 1248 imported.
  - 1249 ○ This implies that there may or may not be an actual Service Template, perhaps it is a
  - 1250 known set Types identified by the well-known URI.
  - 1251 ○ This also implies that internet access is NOT needed to import.
- 1252 • **Alias** – If the <file\_URI> is a reserved TOSCA Namespace alias, then it SHOULD cause the
- 1253 corresponding Type definitions to be imported, using the associated full, Namespace URI to
- 1254 uniquely identify the imported types.

- 1255 • **URL** - If the <file\_URI> is a valid URL (i.e., network accessible as a remote resource) and the
- 1256 location contains a valid TOSCA Service Template, then it SHOULD cause the remote Service
- 1257 Template to be imported.
- 1258 • **Relative path** - If the <file\_URI> is a relative path URL, perhaps pointing to a Service Template
- 1259 located in the same CSAR file, then it SHOULD cause the locally accessible Service Template to
- 1260 be imported.
  - 1261 ○ If the “repository” key is supplied, this could also mean relative to the repository’s URL
  - 1262 in a remote file system;
  - 1263 ○ If the importing file located in a CSAR file, it should be treated as relative to the current
  - 1264 document’s location within a CSAR file’s directory structure.
- 1265 • Otherwise, the import SHOULD be considered a failure.

### 1266 3.6.8.3 Example

1267 The following represents how import definitions would be used for the imports keyname within a TOSCA  
1268 Service Template:

```
imports:
- some_definition_file: path1/path2/some_defs.yaml
- another_definition_file:
  file: path1/path2/file2.yaml
  repository: my_service_catalog
  namespace_uri: http://mycompany.com/tosca/1.0/platform
  namespace_prefix: mycompany
```

## 1269 3.6.9 Property definition

1270 A property definition defines a named, typed value and related data that can be associated with an entity  
1271 defined in this specification (e.g., Node Types, Relationship Types, Capability Types, etc.). Properties  
1272 are used by template authors to provide input values to TOSCA entities which indicate their “desired  
1273 state” when they are instantiated. The value of a property can be retrieved using the `get_property`  
1274 function within TOSCA Service Templates.

### 1275 3.6.9.1.1 Attribute and Property reflection

1276 The actual state of the entity, at any point in its lifecycle once instantiated, is reflected by [Attribute](#)  
1277 [definitions](#). TOSCA orchestrators automatically create an attribute for every declared property (with the  
1278 same symbolic name) to allow introspection of both the desired state (property) and actual state  
1279 (attribute).

### 1280 3.6.9.2 Keynames

1281 The following is the list of recognized keynames for a TOSCA property definition:

Keyname	Required	Type	Constraints	Description
type	yes	string	None	The required data type for the property.
description	no	description	None	The optional description for the property.
required	no	boolean	default: true	An optional key that declares a property as required ( <b>true</b> ) or not ( <b>false</b> ).

Keyname	Required	Type	Constraints	Description
default	no	<any>	None	An optional key that may provide a value to be used as a default if not provided by another means.
status	no	string	default: supported	The optional status of the property relative to the specification or implementation. See table below for valid values.
constraints	no	list of constraint clauses	None	The optional list of sequenced constraint clauses for the property.
entry_schema	no	string	None	The optional key that is used to declare the name of the <a href="#">Datatype definition</a> for entries of set types such as the <a href="#">TOSCA list</a> or <a href="#">map</a> .
external-schema	no	string	None	The optional key that contains a schema definition that TOSCA Orchestrators MAY use for validation when the "type" key's value indicates an External schema (e.g., "json")  See section "External schema" below for further explanation and usage.
metadata	no	map of string	N/A	Defines a section used to declare additional metadata information.

1282 **3.6.9.3 Status values**

1283 The following property status values are supported:

Value	Description
<b>supported</b>	Indicates the property is supported. This is the <b>default</b> value for all property definitions.
<b>unsupported</b>	Indicates the property is not supported.
<b>experimental</b>	Indicates the property is experimental and has no official standing.
<b>deprecated</b>	Indicates the property has been deprecated by a new specification version.

1284 **3.6.9.4 Grammar**

1285 Named property definitions have the following grammar:

```

<property_name>:
  type: <property_type>
  description: <property_description>
  required: <property_required>
  default: <default_value>
  status: <status_value>
  constraints:
    - <property_constraints>
  entry_schema:
    description: <entry_description>
    type: <entry_type>

```

```
constraints:
  - <entry_constraints>
metadata:
  <metadata_map>
```

1286 In the above grammar, the pseudo values that appear in angle brackets have the following meaning:

- 1287 • **property\_name**: represents the required symbolic name of the property as a [string](#).
- 1288 • **property\_description**: represents the optional [description](#) of the property.
- 1289 • **property\_type**: represents the required data type of the property.
- 1290 • **property\_required**: represents an optional [boolean](#) value (true or false) indicating whether or
- 1291 not the property is required. If this keyname is not present on a property definition, then the
- 1292 property SHALL be considered **required** (i.e., true) by **default**.
- 1293 • **default\_value**: contains a type-compatible value that may be used as a default if not provided
- 1294 by another means.
- 1295 • **status\_value**: a [string](#) that contains a keyword that indicates the status of the property relative
- 1296 to the specification or implementation.
- 1297 • **property\_constraints**: represents the optional [sequenced](#) list of one or more [constraint](#)
- 1298 [clauses](#) on the property definition.
- 1299 • **schema\_definition**: represents the optional string that contains schema grammar (from an
- 1300 external specification) that corresponds to the 'type' keyname's value.
- 1301 • **entry\_description**: represents the optional [description](#) of the entry schema.
- 1302 • **entry\_type**: represents the required type name for entries in a [list](#) or [map](#) property type.
- 1303 • **entry\_constraints**: represents the optional [sequenced](#) list of one or more [constraint clauses](#)
- 1304 on entries in a [list](#) or [map](#) property type.
- 1305 • **metadata\_map**: represents the optional map of string.

### 1306 3.6.9.5 Additional Requirements

- 1307 • Implementations of the TOSCA Simple Profile **SHALL** automatically reflect (i.e., make available)
- 1308 any property defined on an entity as an attribute of the entity with the same name as the property.
- 1309 • A property **SHALL** be considered [required by default](#) (i.e., as if the **required** keyname on the
- 1310 definition is set to **true**) unless the definition's **required** keyname is explicitly set to **false**.
- 1311 • The value provided on a property definition's **default** keyname **SHALL** be type compatible with
- 1312 the type declared on the definition's **type** keyname.
- 1313 • Constraints of a property definition **SHALL** be type-compatible with the type defined for that
- 1314 definition.
- 1315 • If a 'schema' keyname is provided, its value (string) **MUST** represent a valid schema definition
- 1316 that matches the recognized external type provided as the value for the 'type' keyname as
- 1317 described by its corresponding schema specification.
- 1318 • TOSCA Orchestrators **MAY** choose to validate the value of the 'schema' keyname in accordance
- 1319 with the corresponding schema specification for any recognized external types.

### 1320 3.6.9.6 Notes

- 1321 • This element directly maps to the **PropertiesDefinition** element defined as part of the
- 1322 schema for most type and entities defined in the [TOSCA v1.0 specification](#).
- 1323 • In the [TOSCA v1.0 specification](#) constraints are expressed in the XML Schema definitions of
- 1324 Node Type properties referenced in the **PropertiesDefinition** element of **NodeType**
- 1325 definitions.

### 1326 3.6.9.7 Example

1327 The following represents an example of a property definition with constraints:

```
properties:
  num_cpus:
    type: integer
    description: Number of CPUs requested for a software node instance.
    default: 1
    required: true
    constraints:
      - valid_values: [ 1, 2, 4, 8 ]
```

### 1328 3.6.10 Property assignment

1329 This section defines the grammar for assigning values to named properties within TOSCA Node and  
1330 Relationship templates that are defined in their corresponding named types.

#### 1331 3.6.10.1 Keynames

1332 The TOSCA property assignment has no keynames.

#### 1333 3.6.10.2 Grammar

1334 Property assignments have the following grammar:

##### 1335 3.6.10.2.1 Short notation:

1336 The following single-line grammar may be used when a simple value assignment is needed:

```
<property_name>: <property_value> | { <property_value_expression> }
```

1337 In the above grammars, the pseudo values that appear in angle brackets have the following meaning:

- 1338 • **property\_name**: represents the name of a property that would be used to select a property  
1339 definition with the same name within on a TOSCA entity (e.g., Node Template, Relationship  
1340 Template, etc.) which is declared in its declared type (e.g., a Node Type, Node Template,  
1341 Capability Type, etc.).
- 1342 • **property\_value**, **property\_value\_expression**: represent the type-compatible value to  
1343 assign to the named property. Property values may be provided as the result from the  
1344 evaluation of an expression or a function.

### 1345 3.6.11 Attribute definition

1346 An attribute definition defines a named, typed value that can be associated with an entity defined in this  
1347 specification (e.g., a Node, Relationship or Capability Type). Specifically, it is used to expose the “actual  
1348 state” of some property of a TOSCA entity after it has been deployed and instantiated (as set by the  
1349 TOSCA orchestrator). Attribute values can be retrieved via the **get\_attribute** function from the  
1350 instance model and used as values to other entities within TOSCA Service Templates.

#### 1351 3.6.11.1 Attribute and Property reflection

1352 TOSCA orchestrators automatically create [Attribute definitions](#) for any [Property definitions](#) declared on  
1353 the same TOSCA entity (e.g., nodes, node capabilities and relationships) in order to make accessible the  
1354 actual (i.e., the current state) value from the running instance of the entity.

1355 **3.6.11.2 Keynames**

1356 The following is the list of recognized keynames for a TOSCA attribute definition:

Keyname	Required	Type	Constraints	Description
type	yes	<a href="#">string</a>	None	The required data type for the attribute.
description	no	<a href="#">description</a>	None	The optional description for the attribute.
default	no	<any>	None	An optional key that may provide a value to be used as a default if not provided by another means.  This value SHALL be type compatible with the type declared by the property definition's <b>type</b> keyname.
status	no	<a href="#">string</a>	default: <a href="#">supported</a>	The optional status of the attribute relative to the specification or implementation. See supported <a href="#">status values</a> defined under the <a href="#">Property definition</a> section.
entry_schema	no	<a href="#">string</a>	None	The optional key that is used to declare the name of the <a href="#">Datatype definition</a> for entries of set types such as the TOSCA <a href="#">list</a> or <a href="#">map</a> .

1357 **3.6.11.3 Grammar**

1358 Attribute definitions have the following grammar:

```
attributes:  
  <attribute name>:  
    type: <attribute type>  
    description: <attribute description>  
    default: <default_value>  
    status: <status value>
```

1359 In the above grammar, the pseudo values that appear in angle brackets have the following meaning:

- 1360 • **attribute\_name**: represents the required symbolic name of the attribute as a [string](#).
- 1361 • **attribute\_type**: represents the required data type of the attribute.
- 1362 • **attribute\_description**: represents the optional [description](#) of the attribute.
- 1363 • **default\_value**: contains a type-compatible value that may be used as a default if not provided
- 1364 by another means.
- 1365 • **status\_value**: contains a value indicating the attribute's status relative to the specification
- 1366 version (e.g., supported, deprecated, etc.). Supported [status values](#) for this keyname are defined
- 1367 under [Property definition](#).

1368 **3.6.11.4 Additional Requirements**

- 1369 • In addition to any explicitly defined attributes on a TOSCA entity (e.g., Node Type,
- 1370 RelationshipType, etc.), implementations of the TOSCA Simple Profile **MUST** automatically
- 1371 reflect (i.e., make available) any property defined on an entity as an attribute of the entity with the
- 1372 same name as the property.
- 1373 • Values for the default keyname **MUST** be derived or calculated from other attribute or operation
- 1374 output values (that reflect the actual state of the instance of the corresponding resource) and not
- 1375 hard-coded or derived from a property settings or inputs (i.e., desired state).

### 1376 3.6.11.5 Notes

- 1377 • Attribute definitions are very similar to [Property definitions](#); however, properties of entities reflect  
1378 an input that carries the template author's requested or desired value (i.e., desired state) which  
1379 the orchestrator (attempts to) use when instantiating the entity whereas attributes reflect the  
1380 actual value (i.e., actual state) that provides the actual instantiated value.
  - 1381 ○ For example, a property can be used to request the IP address of a node using a  
1382 property (setting); however, the actual IP address after the node is instantiated may be  
1383 different and made available by an attribute.

### 1384 3.6.11.6 Example

1385 The following represents a required attribute definition:

```
actual_cpus:  
  type: integer  
  description: Actual number of CPUs allocated to the node instance.
```

### 1386 3.6.12 Attribute assignment

1387 This section defines the grammar for assigning values to named attributes within TOSCA Node and  
1388 Relationship templates which are defined in their corresponding named types.

#### 1389 3.6.12.1 Keynames

1390 The TOSCA attribute assignment has no keynames.

#### 1391 3.6.12.2 Grammar

1392 Attribute assignments have the following grammar:

##### 1393 3.6.12.2.1 Short notation:

1394 The following single-line grammar may be used when a simple value assignment is needed:

```
<attribute_name>: <attribute_value> | { <attribute_value_expression> }
```

##### 1395 3.6.12.2.2 Extended notation:

1396 The following multi-line grammar may be used when a value assignment requires keys in addition to a  
1397 simple value assignment:

```
<attribute_name>:  
  description: <attribute_description>  
  value: <attribute_value> | { <attribute_value_expression> }
```

1398 In the above grammars, the pseudo values that appear in angle brackets have the following meaning:

- 1399 • **attribute\_name**: represents the name of an attribute that would be used to select an attribute  
1400 definition with the same name within on a TOSCA entity (e.g., Node Template, Relationship  
1401 Template, etc.) which is declared (or reflected from a Property definition) in its declared type  
1402 (e.g., a Node Type, Node Template, Capability Type, etc.).
- 1403 • **attribute\_value**, **attribute\_value\_expression**: represent the type-compatible value to  
1404 assign to the named attribute. Attribute values may be provided as the result from the  
1405 evaluation of an expression or a function.

1406 • **attribute\_description**: represents the optional [description](#) of the attribute.

### 1407 3.6.12.3 Additional requirements

1408 • Attribute values **MAY** be provided by the underlying implementation at runtime when requested  
1409 by the `get_attribute` function or it **MAY** be provided through the evaluation of expressions and/or  
1410 functions that derive the values from other TOSCA attributes (also at runtime).

### 1411 3.6.13 Parameter definition

1412 A parameter definition is essentially a TOSCA property definition; however, it also allows a value to be  
1413 assigned to it (as for a TOSCA property assignment). In addition, in the case of output parameters, it can  
1414 optionally inherit the data type of the value assigned to it rather than have an explicit data type defined for  
1415 it.

#### 1416 3.6.13.1 Keynames

1417 The TOSCA parameter definition has all the keynames of a TOSCA Property definition, but in addition  
1418 includes the following additional or changed keynames:

Keyname	Required	Type	Constraints	Description
type	no	<a href="#">string</a>	None	The required data type for the parameter.  <b>Note:</b> This keyname is required for a TOSCA Property definition, but is not for a TOSCA Parameter definition.
value	no	<any>	N/A	The type-compatible value to assign to the named parameter. Parameter values may be provided as the result from the evaluation of an expression or a function.

#### 1419 3.6.13.2 Grammar

1420 Named parameter definitions have the following grammar:

```
<parameter_name>:  
  type: <parameter_type>  
  description: <parameter_description>  
  value: <parameter_value> | { <parameter_value_expression> }  
  required: <parameter_required>  
  default: <parameter_default_value>  
  status: <status_value>  
  constraints:  
    - <parameter_constraints>  
  entry_schema:  
    description: <entry_description>  
    type: <entry_type>  
    constraints:  
      - <entry_constraints>
```

1421 In the above grammar, the pseudo values that appear in angle brackets have the following meaning:



- 1422 • **parameter\_name**: represents the required symbolic name of the parameter as a [string](#).
- 1423 • **parameter\_description**: represents the optional [description](#) of the parameter.
- 1424 • **parameter\_type**: represents the optional data type of the parameter. Note, this keyname is  
1425 required for a TOSCA Property definition, but is not for a TOSCA Parameter definition.
- 1426 • **parameter\_value**, **parameter\_value\_expresssion**: represent the type-compatible value to  
1427 assign to the named parameter. Parameter values may be provided as the result from the  
1428 evaluation of an expression or a function.
- 1429 • **parameter\_required**: represents an optional [boolean](#) value (true or false) indicating whether or  
1430 not the parameter is required. If this keyname is not present on a parameter definition, then the  
1431 property SHALL be considered **required** (i.e., true) by **default**.
- 1432 • **default\_value**: contains a type-compatible value that may be used as a default if not provided  
1433 by another means.
- 1434 • **status\_value**: a [string](#) that contains a keyword that indicates the status of the parameter  
1435 relative to the specification or implementation.
- 1436 • **parameter\_constraints**: represents the optional [sequenced](#) list of one or more [constraint](#)  
1437 [clauses](#) on the parameter definition.
- 1438 • **entry\_description**: represents the optional [description](#) of the entry schema.
- 1439 • **entry\_type**: represents the required type name for entries in a [list](#) or [map](#) parameter type.
- 1440 • **entry\_constraints**: represents the optional [sequenced](#) list of one or more [constraint clauses](#)  
1441 on entries in a [list](#) or [map](#) parameter type.

### 1442 3.6.13.3 Additional Requirements

- 1443 • A parameter **SHALL** be considered [required by default](#) (i.e., as if the **required** keyname on the  
1444 definition is set to **true**) unless the definition's **required** keyname is explicitly set to **false**.
- 1445 • The value provided on a parameter definition's **default** keyname **SHALL** be type compatible  
1446 with the type declared on the definition's **type** keyname.
- 1447 • Constraints of a parameter definition **SHALL** be type-compatible with the type defined for that  
1448 definition.

### 1449 3.6.13.4 Example

1450 The following represents an example of an input parameter definition with constraints:

```
inputs:
  cpus:
    type: integer
    description: Number of CPUs for the server.
    constraints:
      - valid_values: [ 1, 2, 4, 8 ]
```

1451 The following represents an example of an (untyped) output parameter definition:

```
outputs:
  server_ip:
    description: The private IP address of the provisioned server.
    value: { get_attribute: [ my_server, private_address ] }
```

1452

1453 **3.6.14 Operation implementation definition**

1454 An operation implementation definition specifies one or more artifacts (e.g. scripts) to be used as the  
1455 implementation for an operation in an interface.

1456 **3.6.14.1 Keynames**

1457 The following is the list of recognized keynames for a TOSCA operation implementation definition:

Keyname	Required	Type	Description
primary	no	Artifact definition	The optional implementation artifact (i.e., the primary script file within a TOSCA CSAR file).
dependencies	no	list of Artifact definition	The optional ordered list of one or more dependent or secondary implementation artifacts which are referenced by the primary implementation artifact (e.g., a library the script installs or a secondary script).
timeout	No	integer	Timeout value in seconds
operation_host	no	string	The node on which operations should be executed (for TOSCA call_operation activities).  If the operation is associated with an interface on a node type or a relationship template, valid_values are SELF or HOST – referring to the node itself or to the node that is the target of the HostedOn relationship for that node.  If the operation is associated with a relationship type or a relationship template, valid_values are SOURCE or TARGET – referring to the relationship source or target node.  In both cases, the value can also be set to ORCHESTRATOR to indicated that the operation must be executed in the orchestrator environment rather than within the context of the service being orchestrated.

1458 **3.6.14.2 Grammar**

1459 Operation implementation definitions have the following grammars:

1460 **3.6.14.2.1 Short notation for use with single artifact**

1461 The following single-line grammar may be used when only a primary implementation artifact name is  
1462 needed:

```
implementation: <primary_artifact_name>
```

1463 This notation can be used when the primary artifact name uniquely identifies the artifact, either because it  
1464 refers to a named artifact specified in the artifacts section of a type or template, or because it represents  
1465 the name of a script in the CSAR file that contains the definition.

1466 **3.6.14.2.2 Short notation for use with multiple artifact**

1467 The following multi-line short-hand grammar may be used when multiple artifacts are needed, but each of  
1468 the artifacts can be uniquely identified by name as before:

```

implementation:
  primary: <primary_artifact_name>
  dependencies:
    - <list of dependent artifact names>
  operation_host : SELF
  timeout : 60

```

### 1469 3.6.14.2.3 Extended notation for use with single artifact

1470 The following multi-line grammar may be used in Node or Relationship Type or Template definitions when  
 1471 only a single artifact is used but additional information about the primary artifact is needed (e.g. to specify  
 1472 the repository from which to obtain the artifact, or to specify the artifact type when it cannot be derived  
 1473 from the artifact file extension):

```

implementation:
  primary:
    <primary_artifact_definition>
  operation_host : HOST
  timeout : 100

```

### 1474 3.6.14.2.4 Extended notation for use with multiple artifacts

1475 The following multi-line grammar may be used in Node or Relationship Type or Template definitions when  
 1476 there are multiple artifacts that may be needed for the operation to be implemented and additional  
 1477 information about each of the artifacts is required:

```

implementation:
  primary:
    <primary_artifact_definition>
  dependencies:
    - <list of dependent artifact definitions>
  operation_host: HOST
  timeout: 120

```

1478 In the above grammars, the pseudo values that appear in angle brackets have the following meaning:

- 1479 • **primary\_artifact\_name**: represents the optional name (*string*) of an implementation artifact  
 1480 definition (defined elsewhere), or the direct name of an implementation artifact's relative filename  
 1481 (e.g., a service template-relative, path-inclusive filename or absolute file location using a URL).
- 1482 • **primary\_artifact\_definition**: represents a full inline definition of an implementation artifact.
- 1483 • **list\_of\_dependent\_artifact\_names**: represents the optional ordered list of one or more  
 1484 dependent or secondary implementation artifact names (as strings) which are referenced by the  
 1485 primary implementation artifact. TOSCA orchestrators will copy these files to the same location  
 1486 as the primary artifact on the target node so as to make them accessible to the primary  
 1487 implementation artifact when it is executed.
- 1488 • **list\_of\_dependent\_artifact\_definitions**: represents the ordered list of one or more inline  
 1489 definitions of dependent or secondary implementation artifacts. TOSCA orchestrators will copy

1490 these artifacts to the same location as the primary artifact on the target node so as to make them  
1491 accessible to the primary implementation artifact when it is executed.

### 1492 3.6.15 Operation definition

1493 An operation definition defines a named function or procedure that can be bound to an operation  
1494 implementation.

#### 1495 3.6.15.1 Keynames

1496 The following is the list of recognized keynames for a TOSCA operation definition:

Keyname	Required	Type	Description
description	no	<a href="#">description</a>	The optional description string for the associated named operation.
implementation	no	Operation implementation definition	The optional definition of the operation implementation
inputs	no	list of <a href="#">parameter definitions</a>	The optional list of input properties definitions (i.e., parameter definitions) for operation definitions that are within TOSCA Node or Relationship Type definitions. This includes when operation definitions are included as part of a Requirement definition in a Node Type.
	no	list of <a href="#">property assignments</a>	The optional list of input property assignments (i.e., parameters assignments) for operation definitions that are within TOSCA Node or Relationship Template definitions. This includes when operation definitions are included as part of a Requirement assignment in a Node Template.

#### 1497 3.6.15.2 Grammar

1498 Operation definitions have the following grammars:

##### 1499 3.6.15.2.1 Short notation

1500 The following single-line grammar may be used when the operation's implementation definition is the only  
1501 keyname that is needed, and when the operation implementation definition itself can be specified using a  
1502 single line grammar

```
<operation name>: <implementation artifact name>
```

1503 Extended notation The following multi-line grammar may be used in Node or Relationship Template or  
1504 Type definitions when additional information about the operation is needed:

```
<operation name>:  
  description: <operation description>  
  implementation: <Operation implementation definitionOperation implementation definition>  
  inputs:  
    <property definitions>
```

1505 In the above grammars, the pseudo values that appear in angle brackets have the following meaning:

- 1506
- **operation\_name**: represents the required symbolic name of the operation as a [string](#).

- 1507
- 1508
- 1509
- 1510
- 1511
- 1512
- 1513
- 1514
- 1515
- 1516
- **operation\_description**: represents the optional [description](#) string for the corresponding **operation\_name**.
  - **operation\_implementation\_definition**: represents the optional specification of the operation's implementation).
  - **property\_definitions**: represents the optional list of [property definitions](#) which the TOSCA orchestrator would make available (i.e., or pass) to the corresponding implementation artifact during its execution.
  - **property\_assignments**: represents the optional list of [property assignments](#) for passing parameters to Node or Relationship Template operations providing values for properties defined in their respective type definitions.

1517 **3.6.15.3 Additional requirements**

- 1518
- 1519
- 1520
- 1521
- 1522
- 1523
- 1524
- The default sub-classing behavior for implementations of operations SHALL be override. That is, implementation artifacts assigned in subclasses override any defined in its parent class.
  - Template authors MAY provide property assignments on operation inputs on templates that do not necessarily have a property definition defined in its corresponding type.
  - Implementation artifact file names (e.g., script filenames) may include file directory path names that are relative to the TOSCA service template file itself when packaged within a TOSCA Cloud Service ARchive (CSAR) file.

1525 **3.6.15.4 Examples**

1526 **3.6.15.4.1 Single-line example**

```
interfaces:  
  Standard:  
    start: scripts/start_server.sh
```

1527 **3.6.15.4.2 Multi-line example with shorthand implementation definitions**

```
interfaces:  
  Configure:  
    pre_configure_source:  
      implementation:  
        primary: scripts/pre_configure_source.sh  
      dependencies:  
        - scripts/setup.sh  
        - binaries/library.rpm  
        - scripts/register.py
```

1528 **3.6.15.4.3 Multi-line example with extended implementation definitions**

```
interfaces:  
  Configure:  
    pre_configure_source:
```

```

implementation:
  primary:
    file: scripts/pre_configure_source.sh
    type: toska.artifacts.Implementation.Bash
    repository: my_service_catalog
  dependencies:
    - file : scripts/setup.sh
      type : toska.artifacts.Implementation.Bash
      Repository : my_service_catalog

```

1529 **3.6.16 Interface definition**

1530 An interface definition defines a named interface that can be associated with a Node or Relationship Type

1531 **3.6.16.1 Keynames**

1532 The following is the list of recognized keynames for a TOSCA interface definition:

Keyname	Required	Type	Description
inputs	no	list of <a href="#">property definitions</a>	The optional list of input property definitions available to all defined operations for interface definitions that are within TOSCA Node or Relationship Type definitions. This includes when interface definitions are included as part of a Requirement definition in a Node Type.
	no	list of <a href="#">property assignments</a>	The optional list of input property assignments (i.e., parameters assignments) for interface definitions that are within TOSCA Node or Relationship Template definitions. This includes when interface definitions are referenced as part of a Requirement assignment in a Node Template.

1533 **3.6.16.2 Grammar**

1534 Interface definitions have the following grammar:

1535 **3.6.16.2.1 Extended notation for use in Type definitions**

1536 The following multi-line grammar may be used in Node or Relationship Type definitions:

```

<interface definition name>:
  type: <interface type name>
  inputs:
    <property definitions>
    <operation definitions>

```

1537 **3.6.16.2.2 Extended notation for use in Template definitions**

1538 The following multi-line grammar may be used in Node or Relationship Template definitions:

```

<interface definition name>:
  inputs:

```

```
<property_assignments>
<operation_definitions>
```

1539 In the above grammars, the pseudo values that appear in angle brackets have the following meaning:

- 1540 • **interface\_definition\_name**: represents the required symbolic name of the interface as a  
1541 [string](#).
- 1542 • **interface\_type\_name**: represents the required name of the Interface Type for the interface  
1543 **definition**.
- 1544 • **property\_definitions**: represents the optional list of [property definitions](#) (i.e., parameters)  
1545 which the TOSCA orchestrator would make available (i.e., or pass) to all defined operations.  
1546 - *This means these properties and their values would be accessible to the implementation*  
1547 *artifacts (e.g., scripts) associated to each operation during their execution.*
- 1548 • **property\_assignments**: represents the optional list of [property assignments](#) for passing  
1549 parameters to Node or Relationship Template operations providing values for properties defined  
1550 in their respective type definitions.
- 1551 • **operation\_definitions**: represents the required name of one or more [operation definitions](#).

### 1552 3.6.17 Event Filter definition

1553 An event filter definition defines criteria for selection of an attribute, for the purpose of monitoring it, within  
1554 a TOSCA entity, or one its capabilities.

#### 1555 3.6.17.1 Keynames

1556 The following is the list of recognized keynames for a TOSCA event filter definition:

Keyname	Required	Type	Description
node	yes	string	The required name of the node type or template that contains either the attribute to be monitored or contains the requirement that references the node that contains the attribute to be monitored.
requirement	no	string	The optional name of the requirement within the filter's node that can be used to locate a referenced node that contains an attribute to monitor.
capability	no	string	The optional name of a capability within the filter's node or within the node referenced by its requirement that contains the attribute to monitor.

#### 1557 3.6.17.2 Grammar

1558 Event filter definitions have following grammar:

```
node: <node_type_name> | <node_template_name>
requirement: <requirement_name>
capability: <capability_name>
```

1559 In the above grammar, the pseudo values that appear in angle brackets have the following meaning:

- 1560 • **node\_type\_name**: represents the required name of the node type that would be used to select  
1561 (filter) the node that contains the attribute to monitor or contains the requirement that references  
1562 another node that contains the attribute to monitor.

- 1563 • **node\_template\_name**: represents the required name of the node template that would be used to  
1564 select (filter) the node that contains the attribute to monitor or contains the requirement that  
1565 references another node that contains the attribute to monitor.
- 1566 • **requirement\_name**: represents the optional name of the requirement that would be used to  
1567 select (filter) a referenced node that contains the attribute to monitor.
- 1568 • **capability\_name**: represents the optional name of a capability that would be used to select  
1569 (filter) the attribute to monitor.

### 1570 3.6.18 Trigger definition

1571 A trigger definition defines the event, condition and action that is used to “trigger” a policy it is associated  
1572 with.

#### 1573 3.6.18.1 Keynames

1574 The following is the list of recognized keynames for a TOSCA trigger definition:

Keyname	Required	Type	Description
description	no	<a href="#">description</a>	The optional description string for the named trigger.
event_type	no	<a href="#">string</a>	The required name of the event type that activates the trigger’s action.
schedule	no	<a href="#">TimeInterval</a>	The optional time interval during which the trigger is valid (i.e., during which the declared actions will be processed).
target_filter	no	<a href="#">event filter</a>	The optional filter used to locate the attribute to monitor for the trigger’s defined condition. This filter helps locate the TOSCA entity (i.e., node or relationship) or further a specific capability of that entity that contains the attribute to monitor.
condition	no	List of <a href="#">condition clause definition</a>	The optional condition which contains a condition clause definition specifying one or multiple attribute constraint that can be monitored. Note: this is optional since sometimes the event occurrence itself is enough to trigger the action.
action	yes	<a href="#">string</a> or <a href="#">operation</a>	The if of the workflow to be invoked when the event is triggered and the condition is met (i.e, evaluates to true). Or The required operation to invoke when the event is triggered and the condition is met (i.e., evaluates to true).

#### 1575 3.6.18.2 Additional keynames for the extended condition notation

Keyname	Required	Type	Description
constraint	no	List of <a href="#">condition clause definition</a>	The optional condition which contains a condition clause definition specifying one or multiple attribute constraint that can be monitored. Note: this is optional since sometimes the event occurrence itself is enough to trigger the action.
period	no	<a href="#">scalar-unit.time</a>	The optional period to use to evaluate for the condition.
evaluations	no	<a href="#">integer</a>	The optional number of evaluations that must be performed over the period to assert the condition exists.
method	no	<a href="#">string</a>	The optional statistical method name to use to perform the evaluation of the condition.



1576 **3.6.18.3 Grammar**

1577 Trigger definitions have the following grammars:

1578 **3.6.18.3.1 Short notation**

1579

```
<trigger_name>:  
  description: <trigger_description>  
  event: <event_type_name>  
  schedule: <time_interval_for_trigger>  
  target_filter:  
    <event_filter_definition>  
  condition:  
    <condition_clause_definition>  
  action:  
    <operation_definition>
```

1580 **3.6.18.3.2 Extended notation:**

1581

```
<trigger_name>:  
  description: <trigger_description>  
  event:  
    type: <event_type_name>  
  schedule: <time_interval_for_trigger>  
  target_filter:  
    <event_filter_definition>  
  condition:  
    constraint: <condition_clause_definition>  
    period: <scalar-unit.time> # e.g., 60 sec  
    evaluations: <integer> # e.g., 1  
    method: <string> # e.g., average  
  action:  
    <operation_definition>
```

1582

1583 In the above grammars, the pseudo values that appear in angle brackets have the following meaning:

- 1584 • **trigger\_name**: represents the required symbolic name of the trigger as a **string**.
- 1585 • **trigger\_description**: represents the optional **description** string for the corresponding
- 1586 **trigger\_name**.
- 1587 • **event\_type\_name**: represents the required name of the TOSCA Event Type that would be
- 1588 monitored on the identified resource (node).
- 1589 • **time\_interval\_for\_trigger**: **represents the optional time interval that the trigger is valid**
- 1590 **for**.

- 1591 • **event\_filter\_definition:** represents the optional filter to use to locate the resource (node)  
1592 or capability attribute to monitor.
- 1593 • **attribute\_constraint\_clause:** represents the optional attribute constraint that would be  
1594 used to test for a specific condition on the monitored resource.
- 1595 • **operation\_definition:** represents the required action to take if the event and (optionally)  
1596 condition are met.

### 1597 3.6.19 Workflow activity definition

1598 A workflow activity defines an operation to be performed in a TOSCA workflow. Activities allows to:

1599

- 1600 • Delegate the workflow for a node expected to be provided by the orchestrator
- 1601 • Set the state of a node
- 1602 • Call an operation defined on a TOSCA interface of a node, relationship or group
- 1603 • Inline another workflow defined in the topology (to allow reusability)

#### 1604 3.6.19.1 Keynames

1605 The following is the list of recognized keynames for a TOSCA workflow activity definition. Note that while  
1606 each of the key is not required, one and only one of them is required (mutually exclusive).

Keyname	Required	Type	Description
delegate	no	string	The name of the delegate workflow.  This activity requires the target to be provided by the orchestrator (no-op node or relationship)
set_state	no	string	Value of the node state.
call_operation	no	string	A string that defines the name of the interface and operation to be called on the node using the <interface_name>.<operation_name> notation.
inline	no	string	The name of a workflow to be inlined.

#### 1607 3.6.19.2 Grammar

1608 Workflow activity definitions have one of the following grammars:

##### 1609 3.6.19.2.1 Delegate activity

```
- delegate: <delegate_workflow_name>
```

1610 In the above grammar, the pseudo values that appear in angle brackets have the following meaning:

- 1611 • **delegate\_workflow\_name:** represents the name of the workflow of the node  
1612 provided by the TOSCA orchestrator.

##### 1613 3.6.19.2.2 Set state activity

```
- set_state: <new_node_state>
```

1614 In the above grammar, the pseudo values that appear in angle brackets have the following meaning:

- 1615 • **new\_node\_state:** represents the state that will be affected to the node once  
1616 the activity is performed.

### 1617 3.6.19.2.3 Call operation activity:

```
- call_operation: <interface_name>.<operation_name>
```

1618 In the above grammar, the pseudo values that appear in angle brackets have the following meaning:

- 1619 • **interface\_name**: represents the name of the interface in which the operation to  
1620 be called is defined.
- 1621 • **operation\_name**: represents the name of the operation of the interface that  
1622 will be called during the workflow execution.

### 1623 3.6.19.2.4 Inline activity

```
- inline: <workflow_name>
```

1624 In the above grammar, the pseudo values that appear in angle brackets have the following meaning:

- 1625 • **workflow\_name**: represents the name of the workflow to inline.

### 1626 3.6.19.3 Additional Requirements

- 1627 • Keynames are mutually exclusive, i.e. an activity MUST define only one of delegate, set\_state,  
1628 call\_operation or inline keyname.

### 1629 3.6.19.4 Example

1630 following represents a list of workflow activity definitions:

```
- delegate: deploy  
- set_state: started  
- call_operation: toska.interfaces.node.lifecycle.Standard.start  
- inline: my_workflow
```

1631

### 1632 3.6.20 Assertion definition

1633 A workflow assertion is used to specify a single condition on a workflow filter definition. The assertion  
1634 allows to assert the value of an attribute based on TOSCA constraints.

#### 1635 3.6.20.1 Keynames

1636 The TOSCA workflow assertion definition has no keynames.

#### 1637 3.6.20.2 Grammar

1638 Workflow assertion definitions have the following grammar:

```
<attribute_name>: <list_of_constraint_clauses>
```

1639 In the above grammars, the pseudo values that appear in angle brackets have the following meaning:

- 1640 • **attribute\_name**: represents the name of an attribute defined on the assertion context entity  
1641 (node instance, relationship instance, group instance) and from which value will be evaluated  
1642 against the defined constraint clauses.

- **list\_of\_constraint\_clauses:** represents the list of constraint clauses that will be used to validate the attribute assertion.

### 3.6.20.3 Example

Following represents a workflow assertion with a single equals constraint:

```
my_attribute: [{equal : my_value}]
```

Following represents a workflow assertion with multiple constraints:

```
my_attribute:
  - min_length: 8
  - max_length : 10
```

### 3.6.21 Condition clause definition

A workflow condition clause definition is used to specify a condition that can be used within a workflow precondition or workflow filter.

#### 3.6.21.1 Keynames

The following is the list of recognized keynames for a TOSCA workflow condition definition:

Keyname	Required	Type	Description
and	no	list of <a href="#">condition clause definition</a>	An <b>and</b> clause allows to define sub-filter clause definitions that must all be evaluated truly so the and clause is considered as true.
or	no	list of <a href="#">condition clause definition</a>	An <b>or</b> clause allows to define sub-filter clause definitions where one of them must all be evaluated truly so the or clause is considered as true.
assert	no	list of <a href="#">assertion definition</a>	A list of filter assertions to be evaluated on entity attributes. <b>Assert</b> acts as a <b>and</b> clause, i.e. every defined filter assertion must be true so the assertion is considered as true.

Note : It is allowed to add assertion definition directly as keynames of the condition clause definition. An and clause is performed for all direct assertion definition.

#### 3.6.21.2 Grammar

Workflow assertion definitions have the following grammars:

##### 3.6.21.2.1 And clause

```
and: <list_of_condition_clause_definition>
```

In the above grammars, the pseudo values that appear in angle brackets have the following meaning:

- **list\_of\_condition\_clause\_definition:** represents the list of condition clauses. All condition clauses MUST be asserted to true so that the and clause is asserted to true.

##### 3.6.21.2.2 Or clause

```
or: <list_of_condition_clause_definition>
```

1663 In the above grammars, the pseudo values that appear in angle brackets have the following meaning:

- 1664 • **list\_of\_condition\_clause\_definition:** represents the list of condition clauses. One of the  
1665 condition clause have to be asserted to true so that the or clause is asserted to true.

### 1666 3.6.21.2.3 Assert clause

```
assert: <list_of_assertion_definition>
```

1667 In the above grammars, the pseudo values that appear in angle brackets have the following meaning:

- 1668 • **list\_of\_assertion\_definition:** represents the list of assertions. All assertions MUST be  
1669 asserted to true so that the assert clause is asserted to true.

### 1670 3.6.21.3 Direct assertion definition

```
<attribute_name>: <list_of_constraint_clauses>
```

1671 In the above grammars, the pseudo values that appear in angle brackets have the following meaning:

- 1672 • **attribute\_name:** represents the name of an attribute defined on the assertion context entity  
1673 (node instance, relationship instance, group instance) and from which value will be evaluated  
1674 against the defined constraint clauses.
- 1675 • **list\_of\_constraint\_clauses:** represents the list of constraint clauses that will be used to validate  
1676 the attribute assertion.

### 1677 3.6.21.4 Additional Requirement

- 1678 • Keynames are mutually exclusive, i.e. a filter definition can define only one of *and*, *or*, or *assert*  
1679 keyname.

### 1680 3.6.21.5 Notes

- 1681 • The TOSCA processor SHOULD perform assertion in the order of the list for every defined  
1682 condition clause or assertion definition.

### 1683 3.6.21.6 Example

1684 Following represents a workflow condition clause with a single equals constraint:

```
condition:  
  - assert:  
    - my_attribute: [{equal: my_value}]
```

1685 Following represents a workflow condition clause with a single equals constraints on two different  
1686 attributes:

```
condition:  
  - assert:  
    - my_attribute: [{equal: my_value}]  
    - my_other_attribute: [{equal: my_other_value}]
```

1687 Following represents a workflow condition clause with a or constraint on two different assertions:

```

condition:
  - or:
    - assert:
      - my_attribute: [{equal: my_value}]
    - assert:
      - my_other_attribute: [{equal: my_other_value}]

```

1688 Following represents multiple levels of condition clauses with direct assertion definition usage to build the  
 1689 following logic: one\_attribute equal one\_value AND (my\_attribute equal my\_value OR my\_other\_attribute  
 1690 equal my\_other\_value):

```

condition:
  - one_attribute: [{equal: one_value }]
  - or:
    - assert:
      - my_attribute: [{equal: my_value}]
    - assert:
      - my_other_attribute: [{equal: my_other_value}]

```

### 1691 3.6.22 Workflow precondition definition

1692 A workflow condition can be used as a filter or precondition to check if a workflow can be processed or  
 1693 not based on the state of the instances of a TOSCA topology deployment. When not met, the workflow  
 1694 will not be triggered.

#### 1695 3.6.22.1 Keynames

1696 The following is the list of recognized keynames for a TOSCA workflow condition definition:

Keyname	Required	Type	Description
target	yes	string	The target of the precondition (this can be a node template name, a group name)
target_relationship	no	string	The optional name of a requirement of the target in case the precondition has to be processed on a relationship rather than a node or group. Note that this is applicable only if the target is a node.
condition	no	list of <a href="#">condition clause definitions</a>	A list of workflow condition clause definitions. Assertion between elements of the condition are evaluated as an AND condition.

#### 1697 3.6.22.2 Grammar

1698 Workflow precondition definitions have the following grammars:

```

- target: <target_name>
  target_relationship: <target_requirement_name>
  condition:
    <list_of_condition_clause_definition>

```

1699 In the above grammar, the pseudo values that appear in angle brackets have the following meaning:

- 1700 • **target\_name**: represents the name of a node template or group in the topology.
- 1701 • **target\_requirement\_name**: represents the name of a requirement of the node template (in case
- 1702 **target\_name** refers to a node template.
- 1703 • **list\_of\_condition\_clause\_definition**: represents the list of condition clauses
- 1704 **to be evaluated. The value of the resulting condition is evaluated as an AND**
- 1705 **clause between the different elements.**

### 1706 3.6.23 Workflow step definition

1707 A workflow step allows to define one or multiple sequenced activities in a workflow and how they are

1708 connected to other steps in the workflow. They are the building blocks of a declarative workflow.

#### 1709 3.6.23.1 Keynames

1710 The following is the list of recognized keynames for a TOSCA workflow step definition:

Keyname	Required	Type	Description
target	yes	string	The target of the step (this can be a node template name, a group name)
target_relationship	no	string	The optional name of a requirement of the target in case the step refers to a relationship rather than a node or group. Note that this is applicable only if the target is a node.
operation_host	no	string	The node on which operations should be executed (for TOSCA call_operation activities). This element is required only for relationships and groups target.  If target is a relationships operation_host is required and valid_values are SOURCE or TARGET – referring to the relationship source or target node.  If target is a group operation_host is optional. If not specified the operation will be triggered on every node of the group. If specified the valid_value is a node_type or the name of a node template.
filter	no	list of constraint clauses	Filter is a map of attribute name, list of constraint clause that allows to provide a filtering logic.
activities	yes	list of activity_definition	The list of sequential activities to be performed in this step.
on_success	no	list of string	The optional list of step names to be performed after this one has been completed with success (all activities has been correctly processed).
on_failure	no	list of string	The optional list of step names to be called after this one in case one of the step activity failed.

#### 1711 3.6.23.2 Grammar

1712 Workflow step definitions have the following grammars:

```
steps:  
  <step_name>
```

```

target: <target_name>
target_relationship: <target_requirement_name>
operation_host: <operation_host_name>
filter:
  - <list_of_condition_clause_definition>
activities:
  - <list_of_activity_definition>
on_success:
  - <target_step_name>
on_failure:
  - <target_step_name>

```

1713 In the above grammar, the pseudo values that appear in angle brackets have the following meaning:

- 1714 • **target\_name**: represents the name of a node template or group in the topology.
- 1715 • **target\_requirement\_name**: represents the name of a requirement of the node template (in case
- 1716 target\_name refers to a node template.
- 1717 • **operation\_host**: the node on which the operation should be executed
- 1718 • **<list\_of\_condition\_clause\_definition>**: represents a list of condition clause definition.
- 1719 • **list\_of\_activity\_definition**: represents a list of activity definition
- 1720 • **target\_step\_name**: represents the name of another step of the workflow.

## 1721 3.7 Type-specific definitions

### 1722 3.7.1 Entity Type Schema

1723 An Entity Type is the common, base, polymorphic schema type which is extended by TOSCA base entity  
 1724 type schemas (e.g., Node Type, Relationship Type, Artifact Type, etc.) and serves to define once all the  
 1725 commonly shared keynames and their types. This is a “meta” type which is abstract and not directly  
 1726 instantiatable.

#### 1727 3.7.1.1 Keynames

1728 The following is the list of recognized keynames for a TOSCA Entity Type definition:

Keyname	Required	Type	Constraints	Description
derived_from	no	string	‘None’ is the only allowed value	An optional parent Entity Type name the Entity Type derives from.
version	no	version	N/A	An optional version for the Entity Type definition.
metadata	no	map of string	N/A	Defines a section used to declare additional metadata information.
description	no	description	N/A	An optional description for the Entity Type.

#### 1729 3.7.1.2 Grammar

1730 Entity Types have following grammar:

```
<entity_keyname>:
```



```

# The only allowed value is 'None'
derived_from: None
version: <version_number>
metadata:
  <metadata_map>
description: <interface_description>

```

1731 In the above grammar, the pseudo values that appear in angle brackets have the following meaning:

- 1732 • **version\_number**: represents the optional TOSCA [version](#) number for the entity.
- 1733 • **entity\_description**: represents the optional [description](#) string for the entity.
- 1734 • **metadata\_map**: represents the optional map of string.

### 1735 3.7.1.3 Additional Requirements

- 1736 • The TOSCA Entity Type SHALL be the common base type used to derive all other top-level base
- 1737 TOSCA Types.
- 1738 • The TOSCA Entity Type SHALL NOT be used to derive or create new base types apart from
- 1739 those defined in this specification or a profile of this specification.

## 1740 3.7.2 Capability definition

1741 A capability definition defines a named, typed set of data that can be associated with Node Type or Node  
1742 Template to describe a transparent capability or feature of the software component the node describes.

### 1743 3.7.2.1 Keynames

1744 The following is the list of recognized keynames for a TOSCA capability definition:

Keyname	Required	Type	Constraints	Description
type	yes	<a href="#">string</a>	N/A	The required name of the Capability Type the capability definition is based upon.
description	no	<a href="#">description</a>	N/A	The optional description of the Capability definition.
properties	no	list of <a href="#">property definitions</a>	N/A	An optional list of property definitions for the Capability definition.
attributes	no	list of <a href="#">attribute definitions</a>	N/A	An optional list of attribute definitions for the Capability definition.
valid_source_types	no	<a href="#">string</a> []	N/A	An optional list of one or more valid names of Node Types that are supported as valid sources of any relationship established to the declared Capability Type.
occurrences	no	<a href="#">range of integer</a>	implied default of [1,UNBOUNDED]	The optional minimum and maximum occurrences for the capability. By default, an exported Capability should allow at least one relationship to be formed with it with a maximum of UNBOUNDED relationships. Note: the keyword <b>UNBOUNDED</b> is also supported to represent any positive integer.

## 1745 3.7.2.2 Grammar

1746 Capability definitions have one of the following grammars:

### 1747 3.7.2.2.1 Short notation

1748 The following grammar may be used when only a list of capability definition names needs to be declared:

```
<capability_definition_name>: <capability_type>
```

### 1749 3.7.2.2.2 Extended notation

1750 The following multi-line grammar may be used when additional information on the capability definition is  
1751 needed:

```
<capability_definition_name>:  
  type: <capability_type>  
  description: <capability_description>  
  properties:  
    <property_definitions>  
  attributes:  
    <attribute_definitions>  
  valid_source_types: [ <node_type_names> ]
```

1752 In the above grammars, the pseudo values that appear in angle brackets have the following meaning:

- 1753 • **capability\_definition\_name**: represents the symbolic name of the capability as a [string](#).
- 1754 • **capability\_type**: represents the required name of a [capability type](#) the capability definition is  
1755 based upon.
- 1756 • **capability\_description**: represents the optional [description](#) of the capability definition.
- 1757 • **property\_definitions**: represents the optional list of [property definitions](#) for the capability  
1758 definition.
- 1759 • **attribute\_definitions**: represents the optional list of [attribute definitions](#) for the capability  
1760 definition.
- 1761 • **node\_type\_names**: represents the optional list of one or more names of [Node Types](#) that the  
1762 Capability definition supports as valid sources for a successful relationship to be established to  
1763 itself.

## 1764 3.7.2.3 Examples

1765 The following examples show capability definitions in both simple and full forms:

### 1766 3.7.2.3.1 Simple notation example

```
# Simple notation, no properties defined or augmented  
some_capability: mytypes.mycapabilities.MyCapabilityTypeName
```

### 1767 3.7.2.3.2 Full notation example

```
# Full notation, augmenting properties of the referenced capability type
```

```

some_capability:
  type: mytypes.mycapabilities.MyCapabilityTypeName
  properties:
    limit:
      type: integer
      default: 100

```

1768 **3.7.2.4 Additional requirements**

- 1769
- 1770
- 1771
- 1772
- 1773
- Any Node Type (names) provides as values for the **valid\_source\_types** keyname SHALL be type-compatible (i.e., derived from the same parent Node Type) with any Node Types defined using the same keyname in the parent Capability Type.
  - Capability symbolic names SHALL be unique; it is an error if a capability name is found to occur more than once.

1774 **3.7.2.5 Notes**

- 1775
- 1776
- 1777
- 1778
- The Capability Type, in this example **MyCapabilityTypeName**, would be defined elsewhere and have an integer property named **limit**.
  - This definition directly maps to the **CapabilitiesDefinition** of the Node Type entity as defined in the [TOSCA v1.0 specification](#).

1779 **3.7.3 Requirement definition**

1780 The Requirement definition describes a named requirement (dependencies) of a TOSCA Node Type or  
 1781 Node template which needs to be fulfilled by a matching Capability definition declared by another TOSCA  
 1782 modelable entity. The requirement definition may itself include the specific name of the fulfilling entity  
 1783 (explicitly) or provide an abstract type, along with additional filtering characteristics, that a TOSCA  
 1784 orchestrator can use to fulfill the capability at runtime (implicitly).

1785 **3.7.3.1 Keynames**

1786 The following is the list of recognized keynames for a TOSCA requirement definition:

Keyname	Required	Type	Constraints	Description
capability	yes	string	N/A	The required reserved keyname used that can be used to provide the name of a valid <a href="#">Capability Type</a> that can fulfill the requirement.
node	no	string	N/A	The optional reserved keyname used to provide the name of a valid <a href="#">Node Type</a> that contains the capability definition that can be used to fulfill the requirement.
relationship	no	string	N/A	The optional reserved keyname used to provide the name of a valid <a href="#">Relationship Type</a> to construct when fulfilling the requirement.
occurrences	no	range of integer	implied default of [1,1]	The optional minimum and maximum occurrences for the requirement. Note: the keyword <b>UNBOUNDED</b> is also supported to represent any positive integer.

### 1787 3.7.3.1.1 Additional Keynames for multi-line relationship grammar

1788 The Requirement definition contains the Relationship Type information needed by TOSCA Orchestrators  
1789 to construct relationships to other TOSCA nodes with matching capabilities; however, it is sometimes  
1790 recognized that additional properties may need to be passed to the relationship (perhaps for  
1791 configuration). In these cases, additional grammar is provided so that the Node Type may declare  
1792 additional Property definitions to be used as inputs to the Relationship Type's declared interfaces (or  
1793 specific operations of those interfaces).

Keyname	Required	Type	Constraints	Description
type	yes	string	N/A	The optional reserved keyname used to provide the name of the Relationship Type for the requirement definition's <b>relationship</b> keyname.
interfaces	no	list of interface definitions	N/A	The optional reserved keyname used to reference declared (named) interface definitions of the corresponding Relationship Type in order to declare additional Property definitions for these interfaces or operations of these interfaces.

### 1794 3.7.3.2 Grammar

1795 Requirement definitions have one of the following grammars:

#### 1796 3.7.3.2.1 Simple grammar (Capability Type only)

```
<requirement_definition_name>: <capability_type_name>
```

#### 1797 3.7.3.2.2 Extended grammar (with Node and Relationship Types)

```
<requirement_definition_name>:  
  capability: <capability_type_name>  
  node: <node_type_name>  
  relationship: <relationship_type_name>  
  occurrences: [ <min_occurrences>, <max_occurrences> ]
```

#### 1798 3.7.3.2.3 Extended grammar for declaring Property Definitions on the 1799 relationship's Interfaces

1800 The following additional multi-line grammar is provided for the relationship keyname in order to declare  
1801 new Property definitions for inputs of known Interface definitions of the declared Relationship Type.

```
<requirement_definition_name>:  
  # Other keynames omitted for brevity  
  relationship:  
    type: <relationship_type_name>  
    interfaces:  
      <interface_definitions>
```

1802 In the above grammars, the pseudo values that appear in angle brackets have the following meaning:

- 1803 • **requirement\_definition\_name**: represents the required symbolic name of the requirement  
1804 definition as a [string](#).
- 1805 • **capability\_type\_name**: represents the required name of a Capability type that can be used to  
1806 fulfill the requirement.
- 1807 • **node\_type\_name**: represents the optional name of a TOSCA Node Type that contains the  
1808 Capability Type definition the requirement can be fulfilled by.
- 1809 • **relationship\_type\_name**: represents the optional name of a [Relationship Type](#) to be used to  
1810 construct a relationship between this requirement definition (i.e., in the source node) to a  
1811 matching capability definition (in a target node).
- 1812 • **min\_occurrences**, **max\_occurrences**: represents the optional minimum and maximum  
1813 occurrences of the requirement (i.e., its cardinality).
- 1814 • **interface\_definitions**: represents one or more already declared interface definitions in the  
1815 Relationship Type (as declared on the **type** keyname) allowing for the declaration of new  
1816 Property definition for these interfaces or for specific Operation definitions of these interfaces.

### 1817 3.7.3.3 Additional Requirements

- 1818 • Requirement symbolic names SHALL be unique; it is an error if a requirement name is found to  
1819 occur more than once.
- 1820 • If the **occurrences** keyname is not present, then the occurrence of the requirement **SHALL** be  
1821 one and only one; that is a default declaration as follows would be assumed:  
1822     o occurrences: [1,1]

### 1823 3.7.3.4 Notes

- 1824 • This element directly maps to the **RequirementsDefinition** of the Node Type entity as defined  
1825 in the [TOSCA v1.0 specification](#).
- 1826 • The requirement symbolic name is used for identification of the requirement definition only and  
1827 not relied upon for establishing any relationships in the topology.

### 1828 3.7.3.5 Requirement Type definition is a tuple

1829 A requirement definition allows type designers to govern which types are allowed (valid) for fulfillment  
1830 using three levels of specificity with only the Capability Type being required.

- 1831 1. Node Type (optional)
- 1832 2. Relationship Type (optional)
- 1833 3. Capability Type (required)

1834 The first level allows selection, as shown in both the simple or complex grammar, simply providing the  
1835 node's type using the **node** keyname. The second level allows specification of the relationship type to use  
1836 when connecting the requirement to the capability using the **relationship** keyname. Finally, the  
1837 specific named capability type on the target node is provided using the **capability** keyname.

#### 1838 3.7.3.5.1 Property filter

1839 In addition to the node, relationship and capability types, a filter, with the keyname **node\_filter**, may be  
1840 provided to constrain the allowed set of potential target nodes based upon their properties and their  
1841 capabilities' properties. This allows TOSCA orchestrators to help find the "best fit" when selecting among  
1842 multiple potential target nodes for the expressed requirements.

1843 **3.7.4 Artifact Type**

1844 An Artifact Type is a reusable entity that defines the type of one or more files that are used to define  
1845 implementation or deployment artifacts that are referenced by nodes or relationships on their operations.

1846 **3.7.4.1 Keynames**

1847 The Artifact Type is a TOSCA Entity and has the common keynames listed in section 3.7.1 TOSCA Entity  
1848 Schema.

1849 In addition, the Artifact Type has the following recognized keynames:

Keyname	Required	Type	Description
mime_type	no	string	The required mime type property for the Artifact Type.
file_ext	no	string[]	The required file extension property for the Artifact Type.
properties	no	list of property definitions	An optional list of property definitions for the Artifact Type.

1850 **3.7.4.2 Grammar**

1851 Artifact Types have following grammar:

```
<artifact type name>:  
  derived_from: <parent artifact type name>  
  version: <version number>  
  metadata:  
    <map of string>  
  description: <artifact description>  
  mime_type: <mime type string>  
  file_ext: [ <file extensions> ]  
  properties:  
    <property definitions>
```

1852 In the above grammar, the pseudo values that appear in angle brackets have the following meaning:

- 1853 • **artifact\_type\_name**: represents the name of the Artifact Type being declared as a **string**.
- 1854 • **parent\_artifact\_type\_name**: represents the **name** of the **Artifact Type** this Artifact Type  
1855 definition derives from (i.e., its “parent” type).
- 1856 • **version\_number**: represents the optional TOSCA **version** number for the Artifact Type.
- 1857 • **artifact\_description**: represents the optional **description** string for the Artifact Type.
- 1858 • **mime\_type\_string**: represents the optional Multipurpose Internet Mail Extensions (MIME)  
1859 standard string value that describes the file contents for this type of Artifact Type as a **string**.
- 1860 • **file\_extensions**: represents the optional list of one or more recognized file extensions for this  
1861 type of artifact type as **strings**.
- 1862 • **property\_definitions**: represents the optional list of **property definitions** for the artifact type.

1863 **3.7.4.3 Examples**

```
my_artifact_type:
```

```
description: Java Archive artifact type
derived_from: tosca.artifact.Root
mime_type: application/java-archive
file_ext: [ jar ]
```

#### 1864 3.7.4.4 Notes

- 1865 • The 'mime\_type' keyname is meant to have values that are Apache mime types such as those  
1866 defined here: <http://svn.apache.org/repos/asf/httpd/httpd/trunk/docs/conf/mime.types>

### 1867 3.7.5 Interface Type

1868 An Interface Type is a reusable entity that describes a set of operations that can be used to interact with  
1869 or manage a node or relationship in a TOSCA topology.

#### 1870 3.7.5.1 Keynames

1871 The Interface Type is a TOSCA Entity and has the common keynames listed in section 3.7.1 TOSCA  
1872 Entity Schema.

1873 In addition, the Interface Type has the following recognized keynames:

Keyname	Required	Type	Description
inputs	no	list of <a href="#">property definitions</a>	The optional list of input parameter definitions.

#### 1874 3.7.5.2 Grammar

1875 Interface Types have following grammar:

```
<interface type name>:
  derived_from: <parent interface type name>
  version: <version_number>
  metadata:
    <map of string>
  description: <interface description>
  inputs:
    <property definitions>
    <operation definitions>
```

1876 In the above grammar, the pseudo values that appear in angle brackets have the following meaning:

- 1877 • **interface\_type\_name**: represents the required name of the interface as a [string](#).
- 1878 • **parent\_interface\_type\_name**: represents the name of the [Interface Type](#) this Interface Type  
1879 definition derives from (i.e., its "parent" type).
- 1880 • **version\_number**: represents the optional TOSCA [version](#) number for the Interface Type.
- 1881 • **interface\_description**: represents the optional [description](#) string for the Interface Type.
- 1882 • **property\_definitions**: represents the optional list of [property definitions](#) (i.e., parameters)  
1883 which the TOSCA orchestrator would make available (i.e., or pass) to all implementation artifacts  
1884 for operations declared on the interface during their execution.

1885       • **operation\_definitions**: represents the required list of one or more [operation definitions](#).

### 1886 **3.7.5.3 Example**

1887 The following example shows a custom interface used to define multiple configure operations.

```
mycompany.mytypes.myinterfaces.MyConfigure:
  derived_from: toska.interfaces.relationship.Root
  description: My custom configure Interface Type
  inputs:
    mode:
      type: string
  pre_configure_service:
    description: pre-configure operation for my service
  post_configure_service:
    description: post-configure operation for my service
```

### 1888 **3.7.5.4 Additional Requirements**

- 1889       • Interface Types **MUST NOT** include any implementations for defined operations; that is, the  
1890       implementation keyname is invalid.
- 1891       • The **inputs** keyname is reserved and **SHALL NOT** be used for an operation name.

### 1892 **3.7.6 Data Type**

1893 A Data Type definition defines the schema for new named datatypes in TOSCA.

#### 1894 **3.7.6.1 Keynames**

1895 The Data Type is a TOSCA Entity and has the common keynames listed in section 3.7.1 TOSCA Entity  
1896 Schema.

1897 In addition, the Data Type has the following recognized keynames:

Keyname	Required	Type	Description
constraints	no	list of <a href="#">constraint clauses</a>	The optional list of <i>sequenced</i> constraint clauses for the Data Type.
properties	no	list of <a href="#">property definitions</a>	The optional list property definitions that comprise the schema for a complex Data Type in TOSCA.

#### 1898 **3.7.6.2 Grammar**

1899 Data Types have the following grammar:

```
<data_type_name>:
  derived_from: <existing_type_name>
  version: <version number>
  metadata:
```



```
<map of string>
description: <datatype description>
constraints:
  - <type constraints>
properties:
  <property definitions>
```

1900 In the above grammar, the pseudo values that appear in angle brackets have the following meaning:

- 1901 • **data\_type\_name**: represents the required symbolic name of the Data Type as a [string](#).
- 1902 • **version\_number**: represents the optional TOSCA [version](#) number for the Data Type.
- 1903 • **datatype\_description**: represents the optional [description](#) for the Data Type.
- 1904 • **existing\_type\_name**: represents the optional name of a valid TOSCA type this new Data
- 1905 Type would derive from.
- 1906 • **type\_constraints**: represents the optional [sequenced](#) list of one or more type-compatible
- 1907 [constraint clauses](#) that restrict the Data Type.
- 1908 • **property\_definitions**: represents the optional list of one or more [property definitions](#) that
- 1909 provide the schema for the Data Type.

### 1910 3.7.6.3 Additional Requirements

- 1911 • A valid datatype definition **MUST** have either a valid **derived\_from** declaration or at least one
- 1912 valid property definition.
- 1913 • Any **constraint** clauses **SHALL** be type-compatible with the type declared by the
- 1914 **derived\_from** keyname.
- 1915 • If a **properties** keyname is provided, it **SHALL** contain one or more valid property definitions.

### 1916 3.7.6.4 Examples

1917 The following example represents a Data Type definition based upon an existing string type:

#### 1918 3.7.6.4.1 Defining a complex datatype

```
# define a new complex datatype
mytypes.phonenumber:
  description: my phone number datatype
  properties:
    countrycode:
      type: integer
    areacode:
      type: integer
    number:
      type: integer
```

#### 1919 3.7.6.4.2 Defining a datatype derived from an existing datatype

```
# define a new datatype that derives from existing type and extends it
mytypes.phonenumber.extended:
  derived_from: mytypes.phonenumber
```

```

description: custom phone number type that extends the basic phonenumber type
properties:
  phone_description:
    type: string
    constraints:
      - max_length: 128

```

## 1920 3.7.7 Capability Type

1921 A Capability Type is a reusable entity that describes a kind of capability that a Node Type can declare to  
 1922 expose. Requirements (implicit or explicit) that are declared as part of one node can be matched to (i.e.,  
 1923 fulfilled by) the Capabilities declared by another node.

### 1924 3.7.7.1 Keynames

1925 The Capability Type is a TOSCA Entity and has the common keynames listed in section 3.7.1 TOSCA  
 1926 Entity Schema.

1927 In addition, the Capability Type has the following recognized keynames:

Keyname	Required	Type	Description
properties	no	list of <a href="#">property definitions</a>	An optional list of property definitions for the Capability Type.
attributes	no	list of <a href="#">attribute definitions</a>	An optional list of attribute definitions for the Capability Type.
valid_source_types	no	<a href="#">string</a> []	An optional list of one or more valid names of Node Types that are supported as valid sources of any relationship established to the declared Capability Type.

### 1928 3.7.7.2 Grammar

1929 Capability Types have following grammar:

```

<capability_type_name>:
  derived_from: <parent_capability_type_name>
  version: <version_number>
  description: <capability_description>
  properties:
    <property_definitions>
  attributes:
    <attribute_definitions>
  valid_source_types: [ <node_type_names> ]

```

1930 In the above grammar, the pseudo values that appear in angle brackets have the following meaning:

- 1931 • **capability\_type\_name**: represents the required name of the Capability Type being declared as  
 1932 a [string](#).
- 1933 • **parent\_capability\_type\_name**: represents the name of the [Capability Type](#) this Capability  
 1934 Type definition derives from (i.e., its “parent” type).

- 1935 • **version\_number**: represents the optional TOSCA [version](#) number for the Capability Type.
- 1936 • **capability\_description**: represents the optional [description](#) string for the corresponding
- 1937 **capability\_type\_name**.
- 1938 • **property\_definitions**: represents an optional list of [property definitions](#) that the Capability
- 1939 type exports.
- 1940 • **attribute\_definitions**: represents the optional list of [attribute definitions](#) for the Capability
- 1941 Type.
- 1942 • **node\_type\_names**: represents the optional list of one or more names of [Node Types](#) that the
- 1943 Capability Type supports as valid sources for a successful relationship to be established to itself.

### 1944 3.7.7.3 Example

```
mycompany.mytypes.myapplication.MyFeature:
  derived_from: toska.capabilities.Root
  description: a custom feature of my company's application
  properties:
    my_feature_setting:
      type: string
    my_feature_value:
      type: integer
```

### 1945 3.7.8 Requirement Type

1946 A Requirement Type is a reusable entity that describes a kind of requirement that a Node Type can  
 1947 declare to expose. The TOSCA Simple Profile seeks to simplify the need for declaring specific  
 1948 Requirement Types from nodes and instead rely upon nodes declaring their features sets using TOSCA  
 1949 Capability Types along with a named Feature notation.

1950 Currently, there are no use cases in this TOSCA Simple Profile in YAML specification that utilize an  
 1951 independently defined Requirement Type. This is a desired effect as part of the simplification of the  
 1952 TOSCA v1.0 specification.

### 1953 3.7.9 Node Type

1954 A Node Type is a reusable entity that defines the type of one or more Node Templates. As such, a Node  
 1955 Type defines the structure of observable properties via a *Properties Definition, the Requirements and*  
 1956 *Capabilities of the node as well as its supported interfaces.*

#### 1957 3.7.9.1 Keynames

1958 The Node Type is a TOSCA Entity and has the common keynames listed in section 3.7.1 TOSCA Entity  
 1959 Schema.

1960 In addition, the Node Type has the following recognized keynames:

Keyname	Required	Type	Description
attributes	no	list of <a href="#">attribute definitions</a>	An optional list of attribute definitions for the Node Type.
properties	no	list of <a href="#">property definitions</a>	An optional list of property definitions for the Node Type.

Keyname	Required	Type	Description
requirements	no	list of <a href="#">requirement definitions</a>	An optional <i>sequenced</i> list of requirement definitions for the Node Type.
capabilities	no	list of <a href="#">capability definitions</a>	An optional list of capability definitions for the Node Type.
interfaces	no	list of <a href="#">interface definitions</a>	An optional list of interface definitions supported by the Node Type.
artifacts	no	list of <a href="#">artifact definitions</a>	An optional list of named artifact definitions for the Node Type.

1961 **3.7.9.2 Grammar**

1962 Node Types have following grammar:

```

<node_type_name>:
  derived_from: <parent_node_type_name>
  version: <version_number>
  metadata:
    <map of string>
  description: <node_type_description>
  attributes:
    <attribute_definitions>
  properties:
    <property_definitions>
  requirements:
    - <requirement_definitions>
  capabilities:
    <capability_definitions>
  interfaces:
    <interface_definitions>
  artifacts:
    <artifact_definitions>

```

1963 In the above grammar, the pseudo values that appear in angle brackets have the following meaning:

- 1964 • **node\_type\_name**: represents the required symbolic name of the Node Type being declared.
- 1965 • **parent\_node\_type\_name**: represents the name ([string](#)) of the [Node Type](#) this Node Type
- 1966 definition derives from (i.e., its “parent” type).
- 1967 • **version\_number**: represents the optional TOSCA [version](#) number for the Node Type.
- 1968 • **node\_type\_description**: represents the optional [description](#) string for the corresponding
- 1969 **node\_type\_name**.
- 1970 • **property\_definitions**: represents the optional list of [property definitions](#) for the Node Type.
- 1971 • **attribute\_definitions**: represents the optional list of [attribute definitions](#) for the Node Type.
- 1972 • **requirement\_definitions**: represents the optional *sequenced* list of [requirement definitions](#) for
- 1973 the Node Type.

- 1974 • **capability\_definitions**: represents the optional list of [capability definitions](#) for the Node Type.
- 1975
- 1976 • **interface\_definitions**: represents the optional list of one or more [interface definitions](#) supported by the Node Type.
- 1977
- 1978 • **artifact\_definitions**: represents the optional list of [artifact definitions](#) for the Node Type.

### 1979 3.7.9.3 Additional Requirements

- 1980 • Requirements are intentionally expressed as a sequenced list of TOSCA [Requirement definitions](#)
- 1981 which **SHOULD** be resolved (processed) in sequence order by TOSCA Orchestrators. .

### 1982 3.7.9.4 Best Practices

- 1983 • It is recommended that all Node Types **SHOULD** derive directly (as a parent) or indirectly (as an ancestor) of the TOSCA Root Node Type (i.e., **tosca.nodes.Root**) to promote compatibility and portability. However, it is permitted to author Node Types that do not do so.
- 1984
- 1985
- 1986 • TOSCA Orchestrators, having a full view of the complete application topology template and its resultant dependency graph of nodes and relationships, **MAY** prioritize how they instantiate the nodes and relationships for the application (perhaps in parallel where possible) to achieve the greatest efficiency
- 1987
- 1988
- 1989

### 1990 3.7.9.5 Example

```

my_company.my_types.my_app_node_type:
  derived_from: tosca.nodes.SoftwareComponent
  description: My company's custom applicaton
  properties:
    my_app_password:
      type: string
      description: application password
      constraints:
        - min_length: 6
        - max_length: 10
  attributes:
    my_app_port:
      type: integer
      description: application port number
  requirements:
    - some_database:
      capability: EndPoint.Database
      node: Database
      relationship: ConnectsTo

```

### 1991 3.7.10 Relationship Type

1992 A Relationship Type is a reusable entity that defines the type of one or more relationships between Node  
 1993 Types or Node Templates.

1994 **3.7.10.1 Keynames**

1995 The Relationship Type is a TOSCA Entity and has the common keynames listed in section 3.7.1 TOSCA  
1996 Entity Schema.

1997 In addition, the Relationship Type has the following recognized keynames:

Keyname	Required	Definition/Type	Description
properties	no	list of <a href="#">property definitions</a>	An optional list of property definitions for the Relationship Type.
attributes	no	list of <a href="#">attribute definitions</a>	An optional list of attribute definitions for the Relationship Type.
interfaces	no	list of <a href="#">interface definitions</a>	An optional list of interface definitions interfaces supported by the Relationship Type.
valid_target_types	no	<a href="#">string</a> []	An optional list of one or more names of Capability Types that are valid targets for this relationship.

1998 **3.7.10.2 Grammar**

1999 Relationship Types have following grammar:

```
<relationship\_type\_name>:  
  derived_from: <parent\_relationship\_type\_name>  
  version: <version\_number>  
  metadata:  
    <map of string>  
  description: <relationship\_description>  
  properties:  
    <property\_definitions>  
  attributes:  
    <attribute\_definitions>  
  interfaces:  
    <interface\_definitions>  
  valid_target_types: [ <capability\_type\_names> ]
```

2000 In the above grammar, the pseudo values that appear in angle brackets have the following meaning:

- 2001 • **relationship\_type\_name**: represents the required symbolic name of the Relationship Type  
2002 being declared as a [string](#).
- 2003 • **parent\_relationship\_type\_name**: represents the name ([string](#)) of the [Relationship Type](#) this  
2004 Relationship Type definition derives from (i.e., its “parent” type).
- 2005 • **relationship\_description**: represents the optional [description](#) string for the corresponding  
2006 **relationship\_type\_name**.
- 2007 • **version\_number**: represents the optional TOSCA [version](#) number for the Relationship Type.
- 2008 • **property\_definitions**: represents the optional list of [property definitions](#) for the Relationship  
2009 Type.

- 2010 • **attribute\_definitions**: represents the optional list of [attribute definitions](#) for the Relationship Type.
- 2011
- 2012 • **interface\_definitions**: represents the optional list of one or more names of valid [interface definitions](#) supported by the Relationship Type.
- 2013
- 2014 • **capability\_type\_names**: represents one or more names of valid target types for the relationship (i.e., [Capability Types](#)).
- 2015

### 2016 3.7.10.3 Best Practices

- 2017 • For TOSCA application portability, it is recommended that designers use the normative Relationship types defined in this specification where possible and derive from them for customization purposes.
- 2018
- 2019
- 2020 • The TOSCA Root Relationship Type (**tosca.relationships.Root**) SHOULD be used to derive new types where possible when defining new relationships types. This assures that its normative configuration interface (**tosca.interfaces.relationship.Configure**) can be used in a deterministic way by TOSCA orchestrators.
- 2021
- 2022
- 2023

### 2024 3.7.10.4 Examples

```
mycompanytypes.myrelationships.AppDependency:
  derived_from: toasca.relationships.DependsOn
  valid_target_types: [ mycompanytypes.mycapabilities.SomeAppCapability ]
```

### 2025 3.7.11 Group Type

2026 A Group Type defines logical grouping types for nodes, typically for different management purposes.  
 2027 Groups can effectively be viewed as logical nodes that are not part of the physical deployment topology of  
 2028 an application, yet can have capabilities and the ability to attach policies and interfaces that can be  
 2029 applied (depending on the group type) to its member nodes.

2030  
 2031 Conceptually, group definitions allow the creation of logical “membership” relationships to nodes in a  
 2032 service template that are not a part of the application’s explicit requirement dependencies in the topology  
 2033 template (i.e. those required to actually get the application deployed and running). Instead, such logical  
 2034 membership allows for the introduction of things such as group management and uniform application of  
 2035 policies (i.e., requirements that are also not bound to the application itself) to the group’s members.

#### 2036 3.7.11.1 Keynames

2037 The Group Type is a TOSCA Entity and has the common keynames listed in section 3.7.1 TOSCA Entity  
 2038 Schema.

2039 In addition, the Group Type has the following recognized keynames:

Keyname	Required	Type	Description
attributes	no	list of <a href="#">attribute definitions</a>	An optional list of attribute definitions for the Group Type.
properties	no	list of <a href="#">property definitions</a>	An optional list of property definitions for the Group Type.

Keyname	Required	Type	Description
members	no	<a href="#">string[]</a>	An optional list of one or more names of Node Types that are valid (allowed) as members of the Group Type.  Note: This can be viewed by TOSCA Orchestrators as an implied relationship from the listed members nodes to the group, but one that does not have operational lifecycle considerations. For example, if we were to name this as an explicit Relationship Type we might call this "MemberOf" (group).
requirements	no	list of <a href="#">requirement definitions</a>	An optional <i>sequenced</i> list of requirement definitions for the Group Type.
capabilities	no	list of <a href="#">capability definitions</a>	An optional list of capability definitions for the Group Type.
interfaces	no	list of <a href="#">interface definitions</a>	An optional list of interface definitions supported by the Group Type.

2040 **3.7.11.2 Grammar**

2041 Group Types have one the following grammars:

```

<group_type_name>:
  derived_from: <parent_group_type_name>
  version: <version_number>
  metadata:
    <map of string>
  description: <group_description>
  properties:
    <property_definitions>
  members: [ <list_of_valid_member_types> ]
  requirements:
    - <requirement_definitions>
  capabilities:
    <capability_definitions>
  interfaces:
    <interface_definitions>

```

2042 In the above grammar, the pseudo values that appear in angle brackets have the following meaning:

- 2043 • **group\_type\_name**: represents the required symbolic name of the Group Type being declared as
- 2044 a [string](#).
- 2045 • **parent\_group\_type\_name**: represents the name ([string](#)) of the [Group Type](#) this Group Type
- 2046 definition derives from (i.e., its "parent" type).
- 2047 • **version\_number**: represents the optional TOSCA [version](#) number for the Group Type.
- 2048 • **group\_description**: represents the optional description string for the corresponding
- 2049 **group\_type\_name**.
- 2050 • **property\_definitions**: represents the optional list of [property definitions](#) for the Group Type.
- 2051 • **list\_of\_valid\_member\_types**: represents the optional list of TOSCA types (e.g., Node,
- 2052 Capability or even other Group Types) that are valid member types for being added to (i.e.,
- 2053 members of) the Group Type.



- **interface\_definitions**: represents the optional list of one or more [interface definitions](#) supported by the Group Type.

### 3.7.11.3 Additional Requirements

- Group definitions **SHOULD NOT** be used to define or redefine relationships (dependencies) between nodes that can be expressed using normative TOSCA Relationships (e.g., HostedOn, ConnectsTo, etc.) within a TOSCA topology template.
- The list of values associated with the “members” keyname **MUST** only contain types that are homogenous (i.e., derive from the same type hierarchy).

### 3.7.11.4 Example

The following represents a Group Type definition:

```
group_types:
  mycompany.mytypes.groups.placement:
    description: My company's group type for placing nodes of type Compute
    members: [ tosca.nodes.Compute ]
```

## 3.7.12 Policy Type

A Policy Type defines a type of requirement that affects or governs an application or service's topology at some stage of its lifecycle, but is not explicitly part of the topology itself (i.e., it does not prevent the application or service from being deployed or run if it did not exist).

### 3.7.12.1 Keynames

The Policy Type is a TOSCA Entity and has the common keynames listed in section 3.7.1 TOSCA Entity Schema.

In addition, the Policy Type has the following recognized keynames:

Keyname	Required	Type	Description
properties	no	list of <a href="#">property definitions</a>	An optional list of property definitions for the Policy Type.
targets	no	<a href="#">string[]</a>	An optional list of valid Node Types or Group Types the Policy Type can be applied to.  Note: This can be viewed by TOSCA Orchestrators as an implied relationship to the target nodes, but one that does not have operational lifecycle considerations. For example, if we were to name this as an explicit Relationship Type we might call this “AppliesTo” (node or group).
triggers	no	list of <a href="#">trigger</a>	An optional list of policy triggers for the Policy Type.

### 3.7.12.2 Grammar

Policy Types have the following grammar:

```
<policy_type_name>:
  derived_from: <parent_policy_type_name>
```

```

version: <version_number>
metadata:
  <map of string>
description: <policy_description>
properties:
  <property_definitions>
targets: [ <list_of_valid_target_types> ]
triggers:
  <list_of_trigger_definitions>

```

2074 In the above grammar, the pseudo values that appear in angle brackets have the following meaning:

- 2075 • **policy\_type\_name**: represents the required symbolic name of the Policy Type being declared
- 2076 as a [string](#).
- 2077 • **parent\_policy\_type\_name**: represents the name ([string](#)) of the Policy Type this Policy Type
- 2078 definition derives from (i.e., its “parent” type).
- 2079 • **version\_number**: represents the optional TOSCA [version](#) number for the Policy Type.
- 2080 • **policy\_description**: represents the optional description string for the corresponding
- 2081 **policy\_type\_name**.
- 2082 • **property\_definitions**: represents the optional list of [property definitions](#) for the Policy Type.
- 2083 • **list\_of\_valid\_target\_types**: represents the optional list of TOSCA types (i.e., Group or
- 2084 Node Types) that are valid targets for this Policy Type.
- 2085 • **list\_of\_trigger\_definitions**: represents the optional list of [trigger definitions](#) for the policy.

### 2086 3.7.12.3 Example

2087 The following represents a Policy Type definition:

```

policy_types:
  mycompany.mytypes.policies.placement.Container.Linux:
    description: My company’s placement policy for linux
    derived_from: tosca.policies.Root

```

## 2088 3.8 Template-specific definitions

2089 The definitions in this section provide reusable modeling element grammars that are specific to the Node  
2090 or Relationship templates.

### 2091 3.8.1 Capability assignment

2092 A capability assignment allows node template authors to assign values to properties and attributes for a  
2093 named capability definition that is part of a Node Template’s type definition.

#### 2094 3.8.1.1 Keynames

2095 The following is the list of recognized keynames for a TOSCA capability assignment:

Keyname	Required	Type	Description
properties	no	list of <a href="#">property assignments</a>	An optional list of property definitions for the Capability definition.

Keyname	Required	Type	Description
attributes	no	list of <a href="#">attribute assignments</a>	An optional list of attribute definitions for the Capability definition.

2096 **3.8.1.2 Grammar**

2097 Capability assignments have one of the following grammars:

```
<capability_definition_name>:
  properties:
    <property_assignments>
  attributes:
    <attribute_assignments>
```

2098 In the above grammars, the pseudo values that appear in angle brackets have the following meaning:

- 2099 • **capability\_definition\_name**: represents the symbolic name of the capability as a [string](#).
- 2100 • **property\_assignments**: represents the optional list of [property assignments](#) for the capability
- 2101 definition.
- 2102 • **attribute\_assignments**: represents the optional list of [attribute assignments](#) for the capability
- 2103 definition.

2104 **3.8.1.3 Example**

2105 The following example shows a capability assignment:

2106 **3.8.1.3.1 Notation example**

```
node_templates:
  some_node_template:
    capabilities:
      some_capability:
        properties:
          limit: 100
```

2107 **3.8.2 Requirement assignment**

2108 A Requirement assignment allows template authors to provide either concrete names of TOSCA  
 2109 templates or provide abstract selection criteria for providers to use to find matching TOSCA templates  
 2110 that are used to fulfill a named requirement's declared TOSCA Node Type.

2111 **3.8.2.1 Keynames**

2112 The following is the list of recognized keynames for a TOSCA requirement assignment:

Keyname	Required	Type	Description
capability	no	string	The optional reserved keyname used to provide the name of either a: <ul style="list-style-type: none"> <li>• <b>Capability definition</b> within a <i>target</i> node template that can fulfill the requirement.</li> <li>• <b>Capability Type</b> that the provider will use to select a type-compatible <i>target</i> node template to fulfill the requirement at runtime.</li> </ul>
node	no	string	The optional reserved keyname used to identify the target node of a relationship. specifically, it is used to provide either a: <ul style="list-style-type: none"> <li>• <b>Node Template</b> name that can fulfill the target node requirement.</li> <li>• <b>Node Type</b> name that the provider will use to select a type-compatible node template to fulfill the requirement at runtime.</li> </ul>
relationship	no	string	The optional reserved keyname used to provide the name of either a: <ul style="list-style-type: none"> <li>• <b>Relationship Template</b> to use to relate the <i>source</i> node to the (capability in the) <i>target</i> node when fulfilling the requirement.</li> <li>• <b>Relationship Type</b> that the provider will use to select a type-compatible relationship template to relate the <i>source</i> node to the <i>target</i> node at runtime.</li> </ul>
node_filter	no	node filter	The optional filter definition that TOSCA orchestrators or providers would use to select a type-compatible <i>target</i> node that can fulfill the associated abstract requirement at runtime.

2113 The following is the list of recognized keynames for a TOSCA requirement assignment's **relationship**  
2114 keyname which is used when Property assignments need to be provided to inputs of declared interfaces  
2115 or their operations:

Keyname	Required	Type	Description
type	no	string	The optional reserved keyname used to provide the name of the Relationship Type for the requirement assignment's <b>relationship</b> keyname.
properties	no	list of interface definitions	The optional reserved keyname used to reference declared (named) interface definitions of the corresponding Relationship Type in order to provide Property assignments for these interfaces or operations of these interfaces.

### 2116 3.8.2.2 Grammar

2117 Named requirement assignments have one of the following grammars:

#### 2118 3.8.2.2.1 Short notation:

2119 The following single-line grammar may be used if only a concrete Node Template for the target node  
2120 needs to be declared in the requirement:

```
<requirement_name>: <node_template_name>
```

2121 This notation is only valid if the corresponding Requirement definition in the Node Template's parent  
2122 Node Type declares (at a minimum) a valid Capability Type which can be found in the declared target  
2123 Node Template. A valid capability definition always needs to be provided in the requirement declaration of  
2124 the *source* node to identify a specific capability definition in the *target* node the requirement will form a  
2125 TOSCA relationship with.

2126 **3.8.2.2.2 Extended notation:**

2127 The following grammar would be used if the requirement assignment needs to provide more information  
2128 than just the Node Template name:

```
<requirement_name>:  
  node: <node_template_name> | <node_type_name>  
  relationship: <relationship_template_name> | <relationship_type_name>  
  capability: <capability_symbolic_name> | <capability_type_name>  
  node_filter:  
    <node_filter_definition>  
  occurrences: [ min_occurrences, max_occurrences ]
```

2129 **3.8.2.2.3 Extended grammar with Property Assignments for the relationship's**  
2130 **Interfaces**

2131 The following additional multi-line grammar is provided for the relationship keyname in order to provide  
2132 new Property assignments for inputs of known Interface definitions of the declared Relationship Type.

```
<requirement_name>:  
  # Other keynames omitted for brevity  
  relationship:  
    type: <relationship_template_name> | <relationship_type_name>  
    properties:  
      <property_assignments>  
    interfaces:  
      <interface_assignments>
```

2133 Examples of uses for the extended requirement assignment grammar include:

- 2134 • The need to allow runtime selection of the target node based upon an abstract Node Type rather  
2135 than a concrete Node Template. This may include use of the node\_filter keyname to provide  
2136 node and capability filtering information to find the “best match” of a concrete Node Template at  
2137 runtime.
- 2138 • The need to further clarify the concrete Relationship Template or abstract Relationship Type to  
2139 use when relating the source node’s requirement to the target node’s capability.
- 2140 • The need to further clarify the concrete capability (symbolic) name or abstract Capability Type in  
2141 the target node to form a relationship between.
- 2142 • The need to (further) constrain the occurrences of the requirement in the instance model.

2143 In the above grammars, the pseudo values that appear in angle brackets have the following meaning:

- 2144 • **requirement\_name**: represents the symbolic name of a requirement assignment as a [string](#).
- 2145 • **node\_template\_name**: represents the optional name of a Node Template that contains the  
2146 capability this requirement will be fulfilled by.
- 2147 • **relationship\_template\_name**: represents the optional name of a [Relationship Type](#) to be used  
2148 when relating the requirement appears to the capability in the target node.
- 2149 • **capability\_symbolic\_name**: represents the optional ordered list of specific, required capability  
2150 type or named capability definition within the target Node Type or Template.

- 2151 • **node\_type\_name**: represents the optional name of a TOSCA Node Type the associated named  
2152 requirement can be fulfilled by. This must be a type that is compatible with the Node Type  
2153 declared on the matching requirement (same symbolic name) the requirement's Node Template  
2154 is based upon.
- 2155 • **relationship\_type\_name**: represents the optional name of a [Relationship Type](#) that is  
2156 compatible with the Capability Type in the target node.
- 2157 • **property\_assignments**: represents the optional list of property value assignments for the  
2158 declared relationship.
- 2159 • **interface\_assignments**: represents the optional list of interface definitions for the declared  
2160 relationship used to provide property assignments on inputs of interfaces and operations.
- 2161 • **capability\_type\_name**: represents the optional name of a Capability Type definition within the  
2162 target Node Type this requirement needs to form a relationship with.
- 2163 • **node\_filter\_definition**: represents the optional [node filter](#) TOSCA orchestrators would use  
2164 to fulfill the requirement for selecting a target node. Note that this SHALL only be valid if the **node**  
2165 keyname's value is a Node Type and is invalid if it is a Node Template.

### 2166 3.8.2.3 Examples

#### 2167 3.8.2.3.1 Example 1 – Abstract hosting requirement on a Node Type

2168 A web application node template named 'my\_application\_node\_template' of type **WebApplication**  
2169 declares a requirement named 'host' that needs to be fulfilled by any node that derives from the node  
2170 type **WebServer**.

```
# Example of a requirement fulfilled by a specific web server node template
node_templates:
  my_application_node_template:
    type: tosca.nodes.WebApplication
    ...
    requirements:
      - host:
        node: tosca.nodes.WebServer
```

2171 In this case, the node template's type is **WebApplication** which already declares the Relationship Type  
2172 **HostedOn** to use to relate to the target node and the Capability Type of **Container** to be the specific  
2173 target of the requirement in the target node.

#### 2174 3.8.2.3.2 Example 2 - Requirement with Node Template and a custom Relationship 2175 Type

2176 This example is similar to the previous example; however, the requirement named 'database' describes  
2177 a requirement for a connection to a database endpoint (**Endpoint.Database**) Capability Type in a named  
2178 node template (**my\_database**). However, the connection requires a custom Relationship Type  
2179 (**my.types.CustomDbConnection**) declared on the keyname 'relationship'.

```
# Example of a (database) requirement that is fulfilled by a node template named
# "my_database", but also requires a custom database connection relationship
my_application_node_template:
  requirements:
```

```

- database:
  node: my_database
  capability: Endpoint.Database
  relationship: my.types.CustomDbConnection

```

2180 **3.8.2.3.3 Example 3 - Requirement for a Compute node with additional selection**  
 2181 **criteria (filter)**

2182 This example shows how to extend an abstract ‘host’ requirement for a **Compute** node with a filter  
 2183 definition that further constrains TOSCA orchestrators to include additional properties and capabilities  
 2184 on the target node when fulfilling the requirement.

```

node_templates:
  mysql:
    type: tosca.nodes.DBMS.MySQL
    properties:
      # omitted here for brevity
    requirements:
      - host:
        node: tosca.nodes.Compute
        node_filter:
          capabilities:
            - host:
              properties:
                - num_cpus: { in_range: [ 1, 4 ] }
                - mem_size: { greater_or_equal: 512 MB }
            - os:
              properties:
                - architecture: { equal: x86_64 }
                - type: { equal: linux }
                - distribution: { equal: ubuntu }
            - mytypes.capabilities.compute.encryption:
              properties:
                - algorithm: { equal: aes }
                - keylength: { valid_values: [ 128, 256 ] }

```

2185 **3.8.3 Node Template**

2186 A Node Template specifies the occurrence of a manageable software component as part of an  
 2187 application’s topology model which is defined in a TOSCA Service Template. A Node template is an  
 2188 instance of a specified Node Type and can provide customized properties, constraints or operations  
 2189 which override the defaults provided by its Node Type and its implementations.

2190 **3.8.3.1 Keynames**

2191 The following is the list of recognized keynames for a TOSCA Node Template definition:

Keyname	Required	Type	Description
type	yes	string	The required name of the Node Type the Node Template is based upon.
description	no	description	An optional description for the Node Template.
metadata	no	map of string	Defines a section used to declare additional metadata information.

Keyname	Required	Type	Description
directives	no	string[]	An optional list of directive values to provide processing instructions to orchestrators and tooling.
properties	no	list of <a href="#">property assignments</a>	An optional list of property value assignments for the Node Template.
attributes	no	list of <a href="#">attribute assignments</a>	An optional list of attribute value assignments for the Node Template.
requirements	no	list of <a href="#">requirement assignments</a>	An optional <i>sequenced</i> list of requirement assignments for the Node Template.
capabilities	no	list of <a href="#">capability assignments</a>	An optional list of capability assignments for the Node Template.
interfaces	no	list of <a href="#">interface definitions</a>	An optional list of named interface definitions for the Node Template.
artifacts	no	list of <a href="#">artifact definitions</a>	An optional list of named artifact definitions for the Node Template.
node_filter	no	<a href="#">node filter</a>	The optional filter definition that TOSCA orchestrators would use to select the correct target node. This keyname is only valid if the <b>directive</b> has the value of "selectable" set.
copy	no	string	The optional (symbolic) name of another node template to copy into (all keynames and values) and use as a basis for this node template.

### 2192 3.8.3.2 Grammar

```

<node template name>:
  type: <node type name>
  description: <node template description>
  directives: [<directives>]
  metadata:
    <map of string>
  properties:
    <property assignments>
  attributes:
    <attribute assignments>
  requirements:
    - <requirement assignments>
  capabilities:
    <capability assignments>
  interfaces:
    <interface definitions>
  artifacts:

```



```
<artifact_definitions>
node_filter:
  <node_filter_definition>
copy: <source_node_template_name>
```

2193 In the above grammar, the pseudo values that appear in angle brackets have the following meaning:

- 2194 • **node\_template\_name**: represents the required symbolic name of the Node Template being  
2195 declared.
- 2196 • **node\_type\_name**: represents the name of the Node Type the Node Template is based upon.
- 2197 • **node\_template\_description**: represents the optional [description](#) string for Node Template.
- 2198 • **directives**: represents the optional list of processing instruction keywords (as strings) for use by  
2199 tooling and orchestrators.
- 2200 • **property\_assignments**: represents the optional list of [property assignments](#) for the Node  
2201 Template that provide values for properties defined in its declared Node Type.
- 2202 • **attribute\_assignments**: represents the optional list of [attribute assignments](#) for the Node  
2203 Template that provide values for attributes defined in its declared Node Type.
- 2204 • **requirement\_assignments**: represents the optional *sequenced* list of [requirement assignments](#)  
2205 for the Node Template that allow assignment of type-compatible capabilities, target nodes,  
2206 relationships and target (node filters) for use when fulfilling the requirement at runtime.
- 2207 • **capability\_assignments**: represents the optional list of [capability assignments](#) for the Node  
2208 Template that augment those provided by its declared Node Type.
- 2209 • **interface\_definitions**: represents the optional list of [interface definitions](#) for the Node  
2210 Template that *augment* those provided by its declared Node Type.
- 2211 • **artifact\_definitions**: represents the optional list of [artifact definitions](#) for the Node Template  
2212 that augment those provided by its declared Node Type.
- 2213 • **node\_filter\_definition**: represents the optional [node filter](#) TOSCA orchestrators would use  
2214 for selecting a matching node template.
- 2215 • **source\_node\_template\_name**: represents the optional (symbolic) name of another node  
2216 template to copy into (all keynames and values) and use as a basis for this node template.

### 2217 3.8.3.3 Additional requirements

- 2218 • The **node\_filter** keyword (and supporting grammar) **SHALL** only be valid if the Node Template  
2219 has a **directive** keyname with the value of “**selectable**” set.
- 2220 • The source node template provided as a value on the **copy** keyname **MUST NOT** itself use the  
2221 **copy** keyname (i.e., it must itself be a complete node template description and not copied from  
2222 another node template).

### 2223 3.8.3.4 Example

```
node_templates:
  mysql:
    type: tosca.nodes.DBMS.MySQL
    properties:
      root_password: { get_input: my_mysql_rootpw }
      port: { get_input: my_mysql_port }
```

```

requirements:
  - host: db_server
interfaces:
  Standard:
    configure: scripts/my_own_configure.sh

```

## 2224 3.8.4 Relationship Template

2225 A Relationship Template specifies the occurrence of a manageable relationship between node templates  
 2226 as part of an application's topology model that is defined in a TOSCA Service Template. A Relationship  
 2227 template is an instance of a specified Relationship Type and can provide customized properties,  
 2228 constraints or operations which override the defaults provided by its Relationship Type and its  
 2229 implementations.

### 2230 3.8.4.1 Keynames

2231 The following is the list of recognized keynames for a TOSCA Relationship Template definition:

Keyname	Required	Type	Description
type	yes	string	The required name of the Relationship Type the Relationship Template is based upon.
description	no	description	An optional description for the Relationship Template.
metadata	no	map of string	Defines a section used to declare additional metadata information.
properties	no	list of property assignments	An optional list of property assignments for the Relationship Template.
attributes	no	list of attribute assignments	An optional list of attribute assignments for the Relationship Template.
interfaces	no	list of interface definitions	An optional list of named interface definitions for the Node Template.
copy	no	string	The optional (symbolic) name of another relationship template to copy into (all keynames and values) and use as a basis for this relationship template.

### 2232 3.8.4.2 Grammar

```

<relationship_template_name>:
  type: <relationship_type_name>
  description: <relationship_type_description>
  metadata:
    <map of string>
  properties:
    <property_assignments>
  attributes:
    <attribute_assignments>
  interfaces:

```

```

<interface definitions>
copy:
  <source relationship template name>

```

2233 In the above grammar, the pseudo values that appear in angle brackets have the following meaning:

- 2234 • **relationship\_template\_name**: represents the required symbolic name of the Relationship
- 2235 Template being declared.
- 2236 • **relationship\_type\_name**: represents the name of the Relationship Type the Relationship
- 2237 Template is based upon.
- 2238 • **relationship\_template\_description**: represents the optional [description](#) string for the
- 2239 Relationship Template.
- 2240 • **property\_assignments**: represents the optional list of [property assignments](#) for the Relationship
- 2241 Template that provide values for properties defined in its declared Relationship Type.
- 2242 • **attribute\_assignments**: represents the optional list of [attribute assignments](#) for the
- 2243 Relationship Template that provide values for attributes defined in its declared Relationship Type.
- 2244 • **interface\_definitions**: represents the optional list of [interface definitions](#) for the Relationship
- 2245 Template that augment those provided by its declared Relationship Type.
- 2246 • **source\_relationship\_template\_name**: represents the optional (symbolic) name of another
- 2247 relationship template to copy into (all keynames and values) and use as a basis for this
- 2248 relationship template.

### 2249 3.8.4.3 Additional requirements

- 2250 • The source relationship template provided as a value on the **copy** keyname MUST NOT itself use
- 2251 the **copy** keyname (i.e., it must itself be a complete relationship template description and not
- 2252 copied from another relationship template).

### 2253 3.8.4.4 Example

```

relationship_templates:
  storage_attachment:
    type: AttachesTo
    properties:
      location: /my_mount_point

```

## 2254 3.8.5 Group definition

2255 A group definition defines a logical grouping of node templates, typically for management purposes, but is  
 2256 separate from the application's topology template.

### 2257 3.8.5.1 Keynames

2258 The following is the list of recognized keynames for a TOSCA group definition:

Keyname	Required	Type	Description
type	yes	<a href="#">string</a>	The required name of the group type the group definition is based upon.
description	no	<a href="#">description</a>	The optional description for the group definition.

metadata	no	map of <a href="#">string</a>	Defines a section used to declare additional metadata information.
properties	no	list of <a href="#">property assignments</a>	An optional list of property value assignments for the group definition.
members	no	list of <a href="#">string</a>	The optional list of one or more node template names that are members of this group definition.
interfaces	no	list of <a href="#">interface definitions</a>	An optional list of named interface definitions for the group definition.

### 2259 3.8.5.2 Grammar

2260 Group definitions have one the following grammars:

```

<group\_name>:
  type: <group\_type\_name>
  description: <group\_description>
  metadata:
    <map of string>
  properties:
    <property\_assignments>
  members: [ <list\_of\_node\_templates> ]
  interfaces:
    <interface\_definitions>

```

2261 In the above grammar, the pseudo values that appear in angle brackets have the following meaning:

- 2262 • **group\_name**: represents the required symbolic name of the group as a [string](#).
- 2263 • **group\_type\_name**: represents the name of the Group Type the definition is based upon.
- 2264 • **group\_description**: contains an optional description of the group.
- 2265 • **property\_assignments**: represents the optional list of [property assignments](#) for the group
- 2266 definition that provide values for properties defined in its declared Group Type.
- 2267 • **list\_of\_node\_templates**: contains the required list of one or more node template names
- 2268 (within the same topology template) that are members of this logical group.
- 2269 • **interface\_definitions**: represents the optional list of [interface definitions](#) for the group
- 2270 definition that augment those provided by its declared Group Type.

### 2271 3.8.5.3 Additional Requirements

- 2272 • Group definitions **SHOULD NOT** be used to define or redefine relationships (dependencies) for
- 2273 an application that can be expressed using normative TOSCA Relationships within a TOSCA
- 2274 topology template.

### 2275 3.8.5.4 Example

2276 The following represents a group definition:

```
groups:
```

```

my_app_placement_group:
  type: toska.groups.Root
  description: My application's logical component grouping for placement
  members: [ my_web_server, my_sql_database ]

```

## 2277 3.8.6 Policy definition

2278 A policy definition defines a policy that can be associated with a TOSCA topology or top-level entity  
 2279 definition (e.g., group definition, node template, etc.).

### 2280 3.8.6.1 Keynames

2281 The following is the list of recognized keynames for a TOSCA policy definition:

Keyname	Required	Type	Description
type	yes	string	The required name of the policy type the policy definition is based upon.
description	no	description	The optional description for the policy definition.
metadata	no	map of string	Defines a section used to declare additional metadata information.
properties	no	list of property assignments	An optional list of property value assignments for the policy definition.
targets	no	string[]	An optional list of valid Node Templates or Groups the Policy can be applied to.
triggers	no	list of trigger definitions	An optional list of trigger definitions to invoke when the policy is applied by an orchestrator against the associated TOSCA entity.

### 2282 3.8.6.2 Grammar

2283 Policy definitions have one the following grammars:

```

<policy_name>:
  type: <policy_type_name>
  description: <policy_description>
  metadata:
    <map of string>
  properties:
    <property_assignments>
  targets: [<list_of_policy_targets>]
  triggers:
    <list_of_trigger_definitions>

```

2284 In the above grammar, the pseudo values that appear in angle brackets have the following meaning:

- 2285 • **policy\_name**: represents the required symbolic name of the policy as a **string**.
- 2286 • **policy\_type\_name**: represents the name of the policy the definition is based upon.
- 2287 • **policy\_description**: contains an optional description of the policy.

- 2288 • **property\_assignments**: represents the optional list of [property assignments](#) for the policy definition that provide values for properties defined in its declared Policy Type.
- 2289
- 2290 • **list\_of\_policy\_targets**: represents the optional list of names of node templates or groups that the policy is to applied to.
- 2291
- 2292 • **list\_of\_trigger\_definitions**: represents the optional list of [trigger definitions](#) for the policy.

### 3.8.6.3 Example

2294 The following represents a policy definition:

```

policies:
  - my_compute_placement_policy:
      type: toska.policies.placement
      description: Apply my placement policy to my application's servers
      targets: [ my_server_1, my_server_2 ]
      # remainder of policy definition left off for brevity

```

## 3.8.7 Imperative Workflow definition

2296 A workflow definition defines an imperative workflow that is associated with a TOSCA topology.

### 3.8.7.1 Keynames

2298 The following is the list of recognized keynames for a TOSCA workflow definition:

Keyname	Required	Type	Description
description	no	<a href="#">description</a>	The optional description for the workflow definition.
metadata	no	<a href="#">map of string</a>	Defines a section used to declare additional metadata information.
inputs	no	list of <a href="#">property definitions</a>	The optional list of input parameter definitions.
preconditions	no	list of <a href="#">precondition definitions</a>	List of preconditions to be validated before the workflow can be processed.
steps	No	list of <a href="#">step definitions</a>	An optional list of valid Node Templates or Groups the Policy can be applied to.

### 3.8.7.2 Grammar

2301 Imperative workflow definitions have the following grammar:

```

<workflow_name>:
  description: <workflow_description>
  metadata:
    <map of string>
  inputs:
    <property_definitions>
  preconditions:

```

```

- <workflow_precondition_definition>
steps:
  <workflow_steps>

```

2302 In the above grammar, the pseudo values that appear in angle brackets have the following meaning:

- 2303 • **workflow\_name:**
- 2304 • **workflow\_description:**
- 2305 • **property\_definitions:**
- 2306 • **workflow\_precondition\_definition:**
- 2307 • **workflow\_steps:**

### 2308 3.8.8 Property mapping

2309 A property mapping allows to map the property of a substituted node type to a property definition or value  
 2310 (mapped as a constant value property definition) within the topology template.

2311 A property mapping may refer to an input of the topology, to the property of a node template in the  
 2312 topology or be assigned to a constant value.

#### 2313 3.8.8.1 Keynames

2314 The following is the list of recognized keynames for a TOSCA property mapping:

2315

Keyname	Required	Type	Description
mapping	no	Array of strings	An array of string with a size from 1 to 3 elements. When size is 1 the string references an input of the topology. When size is 2 the first element refers to the name of a node template in the topology and the second element to a property of the node template. When size is 3 the first element refers to the name of a node template in the topology, the second element to a capability, or a requirement of the given node and the third element to a property of the capability or requirement.
value	no	List of property mappings	This keyname allows to set the value to be assigne to this property definition. This field is mutually exclusive with the mapping keyname.

#### 2316 3.8.8.2 Grammar

2317 The single-line grammar of a **property\_mapping** is as follows:

2318

```

<property_name>: <property_value>
<property_name>: [ <input_name> ]
<property_name>: [ <node_template_name>, <node_template_property_name> ]
<property_name>: [ <node_template_name>, <node_template_capability_name> |
<node_template_requirement_name>, <property_name> ]

```

2319 The multi-line grammar is as follows :

```

<property_name>:
  mapping: [ < input_name > ]

```

```

<property_name>:
  mapping: [ <node_template_name>, <node_template_property_name> ]
<property_name>:
  mapping: [ <node_template_name>, <node_template_capability_name> |
<node_template_requirement_name>, <property_name> ]
<property_name>:
  value: <property_value>

```

2320

### 2321 3.8.8.3 Notes

- 2322
- Single line grammar for a property value assignment is not allowed for properties of list type in order to avoid collision with the mapping single line grammar.
- 2323

### 2324 3.8.8.4 Additional constraints

- 2325
- When Input mapping it may be referenced by multiple nodes in the topologies with resulting attributes values that may differ later on in the various nodes. In any situation, the attribute reflecting the property of the substituted type will remain a constant value set to the one of the input at deployment time.
- 2326
- 2327
- 2328

## 2329 3.8.9 Capability mapping

2330 A capability mapping allows to map the capability of one of the node of the topology template to the capability of the node type the service template offers an implementation for.

2331

### 2332 3.8.9.1 Keynames

2333 The following is the list of recognized keynames for a TOSCA capability mapping:

2334

Keyname	Required	Type	Description
mapping	no	Array of 2 strings	An array of 2 strings, the first one being the name of a node template, the second the name of a capability of the specified node template.
properties	no	List of property assignment	This field is mutually exclusive with the mapping keyname and allow to provide a capability for the template and specify it's related properties.
attributes	no	List of attributes assignment	This field is mutually exclusive with the mapping keyname and allow to provide a capability for the template and specify it's related attributes.

2335

### 2336 3.8.9.2 Grammar

2337 The single-line grammar of a **capability\_mapping** is as follows:

2338

```

<capability_name>: [ <node_template_name>, <node_template_capability_name> ]

```

2339 The multi-line grammar is as follows :



```

<capability_name>:
  mapping: [ <node_template_name>, <node_template_capability_name> ]
  properties:
    <property_name>: <property_value>
  attributes:
    <attribute_name>: <attribute_value>

```

2340

2341 In the above grammar, the pseudo values that appear in angle brackets have the following meaning:

- 2342 • **capability\_name**: represents the name of the capability as it appears in the Node Type
- 2343 definition for the Node Type (name) that is declared as the value for on the
- 2344 substitution\_mappings' "node\_type" key.
- 2345 • **node\_template\_name**: represents a valid name of a Node Template definition (within the same
- 2346 topology\_template declaration as the substitution\_mapping is declared).
- 2347 • **node\_template\_capability\_name**: represents a valid name of a [capability definition](#) within the
- 2348 <node\_template\_name> declared in this mapping.
- 2349 • **property\_name**: represents the name of a property of the capability.
- 2350 • **property\_value**: represents the value to assign to a property of the capability.
- 2351 • **attribute\_name**: represents the name a an attribute of the capability.
- 2352 • **attribute\_value**: represents the value to assign to an attribute of the capability.

### 2353 3.8.9.3 Additional requirements

- 2354 • Definition of capability assignment in a capability mapping (through properties and attribute
- 2355 keynames) SHOULD be prohibited for connectivity capabilities as `tosca.capabilities.Endpoint`.

### 2356 3.8.10 Requirement mapping

2357 A requirement mapping allows to map the requirement of one of the node of the topology template to the

2358 requirement of the node type the service template offers an implementation for.

#### 2359 3.8.10.1 Keynames

2360 The following is the list of recognized keynames for a TOSCA requirement mapping:

2361

Keyname	Required	Type	Description
mapping	no	Array of 2 strings	An array of 2 strings, the first one being the name of a node template, the second the name of a requirement of the specified node template.
properties	no	List of property assignment	This field is mutually exclusive with the mapping keyname and allow to provide a requirement for the template and specify it's related properties.
attributes	no	List of attributes assignment	This field is mutually exclusive with the mapping keyname and allow to provide a requirement for the template and specify it's related attributes.

2362

2363 **3.8.10.2 Grammar**

2364 The single-line grammar of a **requirement\_mapping** is as follows:

2365

```
<requirement_name>: [ <node_template_name>, <node_template_requirement_name> ]
```

2366 The multi-line grammar is as follows :

```
<requirement_name>:  
  mapping: [ <node_template_name>, <node_template_requirement_name> ]  
  properties:  
    <property_name>: <property_value>  
  attributes:  
    <attribute_name>: <attribute_value>
```

2367

2368 In the above grammar, the pseudo values that appear in angle brackets have the following meaning:

- 2369 • **requirement\_name**: represents the name of the requirement as it appears in the Node Type  
2370 definition for the Node Type (name) that is declared as the value for on the  
2371 substitution\_mappings' "node\_type" key.
- 2372 • **node\_template\_name**: represents a valid name of a Node Template definition (within the same  
2373 topology\_template declaration as the substitution\_mapping is declared).
- 2374 • **node\_template\_requirement\_name**: represents a valid name of a requirement definition within  
2375 the <node\_template\_name> declared in this mapping.
- 2376 • **property\_name**: represents the name of a property of the requirement.
- 2377 • **property\_value**: represents the value to assign to a property of the requirement.
- 2378 • **attribute\_name**: represents the name a an attribute of the requirement.
- 2379 • **attribute\_value**: represents the value to assign to an attribute of the requirement.

2380 **3.8.10.3 Additional requirements**

- 2381 • Definition of capability assignment in a capability mapping (through properties and attribute  
2382 keynames) SHOULD be prohibited for connectivity capabilities as tosca.capabilities.Endpoint.

2383 **3.8.11 Interface mapping**

2384 An interface mapping allows to map a workflow of the topology template to an operation of the node type  
2385 the service template offers an implementation for.

2386 **3.8.11.1 Grammar**

2387 The grammar of an **interface\_mapping** is as follows:

2388

```
<interface_name>:  
  <operation_name>: <workflow_name>
```

2389 In the above grammar, the pseudo values that appear in angle brackets have the following meaning:

- **interface\_name:** represents the name of the interface as it appears in the Node Type definition for the Node Type (name) that is declared as the value for on the substitution\_mappings' "node\_type" key. Or the name of a new management interface to add to the generated type.
- **operation\_name:** represents the name of the operation as it appears in the interface type definition.
- **workflow\_name:** represents the name of a workflow of the template to map to the specified operation.

### 3.8.11.2 Notes

- Declarative workflow generation will be applied by the TOSCA orchestrator after the topology template have been substituted. Unless one of the normative operation of the standard interface is mapped through an interface mapping. In that case the declarative workflow generation will consider the substitution node as any other node calling the create, configure and start mapped workflows as if they where single operations.
- Operation implementation being TOSCA workflows the TOSCA orchestrator replace the usual operation\_call activity by an inline activity using the specified workflow.

### 3.8.12 Substitution mapping

A substitution mapping allows to create a node type out of a given topology template. This allows the consumption of complex systems using a simplified vision.

#### 3.8.12.1 Keynames

Keyname	Required	Type	Description
node_type	yes	string	The required name of the Node Type the Topology Template is providing an implementation for.
properties	no	List of property mappings	The optional list of properties mapping allowing to map properties of the node_type to inputs, node template properties or values.
capabilities	no	List of capability mappings	The optional list of capabilities mapping.
requirements	no	List of requirement mappings	The optional list of requirements mapping.
interfaces	no	List of interfaces mappings	The optional list of interface mapping allows to map an interface and operations of the node type to implementations that could be either workflows or node template interfaces/operations.

2409

#### 3.8.12.2 Grammar

2411 The grammar of the **substitution\_mapping** section is as follows:

```
node_type: <node_type_name>
properties:
  <property_mappings>
capabilities:
  <capability_mappings>
requirements:
```

```

    <requirement_mappings>
  attributes:
    <attribute_mappings>
  interfaces:
    <interface_mappings>

```

2412 In the above grammar, the pseudo values that appear in angle brackets have the following meaning:

- 2413 • **node\_type\_name**: represents the required Node Type name that the Service Template's topology
- 2414 is offering an implementation for.
- 2415 • **properties**: represents the <optional> list of properties mappings.
- 2416 • **capability\_mappings**: represents the <optional> list of capability mappings.
- 2417 • **requirement\_mappings**: represents the <optional> list of requirement mappings.
- 2418 • **attributes**: represents the <optional> list of attributes mappings.
- 2419 • **interfaces**: represents the <optional> list of interfaces mappings.

### 2420 3.8.12.3 Examples

2421

### 2422 3.8.12.4 Additional requirements

- 2423 • The substitution mapping **MUST** provide mapping for every property, capability and requirement
- 2424 defined in the specified <node\_type>

### 2425 3.8.12.5 Notes

- 2426 • The node\_type specified in the substitution mapping **SHOULD** be abstract (does not provide
- 2427 implementation for normative operations).

## 2428 3.9 Topology Template definition

2429 This section defines the topology template of a cloud application. The main ingredients of the topology  
 2430 template are node templates representing components of the application and relationship templates  
 2431 representing links between the components. These elements are defined in the nested **node\_templates**  
 2432 section and the nested **relationship\_templates** sections, respectively. Furthermore, a topology  
 2433 template allows for defining input parameters, output parameters as well as grouping of node templates.

### 2434 3.9.1 Keynames

2435 The following is the list of recognized keynames for a TOSCA Topology Template:

Keyname	Required	Type	Description
description	no	<a href="#">description</a>	The optional description for the Topology Template.
inputs	no	list of <a href="#">parameter definitions</a>	An optional list of input parameters (i.e., as parameter definitions) for the Topology Template.
node_templates	no	list of <a href="#">node templates</a>	An optional list of node template definitions for the Topology Template.

Keyname	Required	Type	Description
relationship_templates	no	list of <a href="#">relationship templates</a>	An optional list of relationship templates for the Topology Template.
groups	no	list of <a href="#">group definitions</a>	An optional list of Group definitions whose members are node templates defined within this same Topology Template.
policies	no	list of <a href="#">policy definitions</a>	An optional list of Policy definitions for the Topology Template.
outputs	no	list of <a href="#">parameter definitions</a>	An optional list of output parameters (i.e., as parameter definitions) for the Topology Template.
substitution_mappings	no	substitution_mapping	An optional declaration that exports the topology template as an implementation of a Node type.  This also includes the mappings between the external Node Types named capabilities and requirements to existing implementations of those capabilities and requirements on Node templates declared within the topology template.
workflows	no	list of imperative workflow definitions	An optional map of imperative workflow definition for the Topology Template.

2436 **3.9.2 Grammar**

2437 The overall grammar of the **topology\_template** section is shown below.–Detailed grammar definitions  
2438 of the each sub-sections are provided in subsequent subsections.

```

topology_template:
  description: <template description>
  inputs: <input_parameter_list>
  outputs: <output_parameter_list>
  node_templates: <node_template_list>
  relationship_templates: <relationship_template_list>
  groups: <group_definition_list>
  policies:
    - <policy_definition_list>
  workflows: <workflow_list>
  # Optional declaration that exports the Topology Template
  # as an implementation of a Node Type.
  substitution_mappings:
    <substitution\_mappings>

```

2439 In the above grammar, the pseudo values that appear in angle brackets have the following meaning:

- 2440 • **template\_description**: represents the optional [description](#) string for Topology Template.
- 2441 • **input\_parameter\_list**: represents the optional list of input parameters (i.e., as property
- 2442 definitions) for the Topology Template.
- 2443 • **output\_parameter\_list**: represents the optional list of output parameters (i.e., as property
- 2444 definitions) for the Topology Template.
- 2445 • **group\_definition\_list**: represents the optional list of [group definitions](#) whose members are
- 2446 node templates that also are defined within this Topology Template.
- 2447 • **policy\_definition\_list**: represents the optional sequenced list of policy definitions for the
- 2448 Topology Template.
- 2449 • **workflow\_list**: represents the optional list of imperative workflow definitions
- 2450 for the Topology Template.
- 2451 • **node\_template\_list**: represents the optional list of [node template](#) definitions for the Topology
- 2452 Template.
- 2453 • **relationship\_template\_list**: represents the optional list of [relationship templates](#) for the
- 2454 Topology Template.
- 2455 • **node\_type\_name**: represents the optional name of a [Node Type](#) that the Topology Template
- 2456 implements as part of the **substitution\_mappings**.
- 2457 • **map\_of\_capability\_mappings\_to\_expose**: represents the mappings that expose internal
- 2458 capabilities from node templates (within the topology template) as capabilities of the Node Type
- 2459 definition that is declared as part of the **substitution\_mappings**.
- 2460 • **map\_of\_requirement\_mappings\_to\_expose**: represents the mappings of link requirements of
- 2461 the Node Type definition that is declared as part of the **substitution\_mappings** to internal
- 2462 requirements implementations within node templates (declared within the topology template).
- 2463

2464 More detailed explanations for each of the Topology Template grammar's keynames appears in the  
 2465 sections below.

### 2466 3.9.2.1 inputs

2467 The **inputs** section provides a means to define parameters using TOSCA parameter definitions, their  
 2468 allowed values via constraints and default values within a TOSCA Simple Profile template. Input  
 2469 parameters defined in the **inputs** section of a topology template can be mapped to properties of node  
 2470 templates or relationship templates within the same topology template and can thus be used for  
 2471 parameterizing the instantiation of the topology template.

2472  
 2473 This section defines topology template-level input parameter section.

- 2474 • Inputs here would ideally be mapped to BoundaryDefinitions in TOSCA v1.0.
- 2475 • Treat input parameters as fixed global variables (not settable within template)
- 2476 • If not in input take default (nodes use default)

#### 2477 3.9.2.1.1 Grammar

2478 The grammar of the **inputs** section is as follows:

```
inputs:
  <parameter definition list>
```

#### 2479 3.9.2.1.2 Examples

2480 This section provides a set of examples for the single elements of a topology template.

2481 Simple **inputs** example without any constraints:

```
inputs:
  fooName:
    type: string
    description: Simple string typed property definition with no constraints.
    default: bar
```

2482 Example of **inputs** with constraints:

```
inputs:
  SiteName:
    type: string
    description: string typed property definition with constraints
    default: My Site
    constraints:
      - min_length: 9
```

### 2483 3.9.2.2 node\_templates

2484 The **node\_templates** section lists the Node Templates that describe the (software) components that are  
2485 used to compose cloud applications.

#### 2486 3.9.2.2.1 grammar

2487 The grammar of the **node\_templates** section is as follows:

```
node_templates:
  <node_template_defn 1>
  ...
  <node_template_defn n>
```

#### 2488 3.9.2.2.2 Example

2489 Example of **node\_templates** section:

```
node_templates:
  my_webapp_node_template:
    type: WebApplication

  my_database_node_template:
    type: Database
```

### 2490 3.9.2.3 relationship\_templates

2491 The **relationship\_templates** section lists the Relationship Templates that describe the relations  
2492 between components that are used to compose cloud applications.

2493

2494 Note that in the TOSCA Simple Profile, the explicit definition of relationship templates as it was required  
2495 in TOSCA v1.0 is optional, since relationships between nodes get implicitly defined by referencing other  
2496 node templates in the requirements sections of node templates.

### 2497 3.9.2.3.1 Grammar

2498 The grammar of the **relationship\_templates** section is as follows:

```
relationship_templates:  
  <relationship_template_defn_1>  
  ...  
  <relationship_template_defn_n>
```

### 2499 3.9.2.3.2 Example

2500 Example of **relationship\_templates** section:

```
relationship_templates:  
  my_connectsto_relationship:  
    type: tosca.relationships.ConnectsTo  
    interfaces:  
      Configure:  
        inputs:  
          speed: { get_attribute: [ SOURCE, connect_speed ] }
```

### 2501 3.9.2.4 outputs

2502 The **outputs** section provides a means to define the output parameters that are available from a TOSCA  
2503 Simple Profile service template. It allows for exposing attributes of node templates or relationship  
2504 templates within the containing **topology\_template** to users of a service.

### 2505 3.9.2.4.1 Grammar

2506 The grammar of the **outputs** section is as follows:

```
outputs:  
  <parameter_def_list>
```

### 2507 3.9.2.4.2 Example

2508 Example of the **outputs** section:

```
outputs:  
  server_address:  
    description: The first private IP address for the provisioned server.  
    value: { get_attribute: [ HOST, networks, private, addresses, 0 ] }
```



2509 **3.9.2.5 groups**

2510 The **groups** section allows for grouping one or more node templates within a TOSCA Service Template  
2511 and for assigning special attributes like policies to the group.

2512 **3.9.2.5.1 Grammar**

2513 The grammar of the **groups** section is as follows:

```
groups:  
  <group defn 1>  
  ...  
  <group defn n>
```

2514 **3.9.2.5.2 Example**

2515 The following example shows the definition of three Compute nodes in the **node\_templates** section of a  
2516 **topology\_template** as well as the grouping of two of the Compute nodes in a group **server\_group\_1**.

```
node_templates:  
  server1:  
    type: toska.nodes.Compute  
    # more details ...  
  
  server2:  
    type: toska.nodes.Compute  
    # more details ...  
  
  server3:  
    type: toska.nodes.Compute  
    # more details ...  
  
groups:  
  # server2 and server3 are part of the same group  
  server_group_1:  
    type: toska.groups.Root  
    members: [ server2, server3 ]
```

2517 **3.9.2.6 policies**

2518 The **policies** section allows for declaring policies that can be applied to entities in the topology template.

2519 **3.9.2.6.1 Grammar**

2520 The grammar of the **policies** section is as follows:

```
policies:  
  - <policy defn 1>
```

```
- ...
- <policy_defn_n>
```

### 2521 3.9.2.6.2 Example

2522 The following example shows the definition of a placement policy.

```
policies:
  - my_placement_policy:
      type: mycompany.mytypes.policy.placement
```

### 2523 3.9.2.7 substitution\_mapping

2524

#### 2525 3.9.2.7.1 requirement\_mapping

2526 The grammar of a **requirement\_mapping** is as follows:

```
<requirement_name>: [ <node_template_name>, <node_template_requirement_name> ]
```

2527 The multi-line grammar is as follows :

```
<requirement_name>:
  mapping: [ <node_template_name>, <node_template_capability_name> ]
  properties:
    <property_name>: <property_value>
```

- 2528 • **requirement\_name**: represents the name of the requirement as it appears in the Node Type
- 2529 definition for the Node Type (name) that is declared as the value for on the
- 2530 substitution\_mappings' "node\_type" key.
  
- 2531 • **node\_template\_name**: represents a valid name of a Node Template definition (within the same
- 2532 topology\_template declaration as the substitution\_mapping is declared).
  
- 2533 • **node\_template\_requirement\_name**: represents a valid name of a [requirement definition](#) within
- 2534 the <node\_template\_name> declared in this mapping.
- 2535 •

### 2536 3.9.2.7.2 Example

2537 The following example shows the definition of a placement policy.

```
topology_template:

  inputs:
    cpus:
      type: integer
      constraints:
        less_than: 2 # OR use "defaults" key
```

**substitution\_mappings:**

```
node_type: MyService
properties: # Do not care if running or matching (e.g., Compute node)
  # get from outside? Get from constraint?
num_cpus: cpus # Implied "PUSH"
  # get from some node in the topology...
num_cpus: [ <node>, <cap>, <property> ]
# 1) Running
architecture:
  # a) Explicit
  value: { get_property: [some_service, architecture] }
  # b) implicit
  value: [ some_service, <req | cap name>, <property name> architecture ]
  default: "amd"
  # c) INPUT mapping?
  ???
# 2) Catalog (Matching)
architecture:
  constraints: equals: "x86"

capabilities:
  bar: [ some_service, bar ]
requirements:
  foo: [ some_service, foo ]

node_templates:
some_service:
  type: MyService
  properties:
    rate: 100
  capabilities:
    bar:
      ...
  requirements:
    - foo:
      ...
```

2539 **3.9.2.8 Notes**

- 2540 • The parameters (properties) that are listed as part of the **inputs** block can be mapped to
- 2541 **PropertyMappings** provided as part of **BoundaryDefinitions** as described by the TOSCA v1.0
- 2542 specification.
- 2543 • The node templates listed as part of the **node\_templates** block can be mapped to the list of
- 2544 **NodeTemplate** definitions provided as part of **TopologyTemplate** of a **ServiceTemplate** as
- 2545 described by the TOSCA v1.0 specification.
- 2546 • The relationship templates listed as part of the **relationship\_templates** block can be mapped
- 2547 to the list of **RelationshipTemplate** definitions provided as part of **TopologyTemplate** of a
- 2548 **ServiceTemplate** as described by the TOSCA v1.0 specification.
- 2549 • The output parameters that are listed as part of the **outputs** section of a topology template can
- 2550 be mapped to **PropertyMappings** provided as part of **BoundaryDefinitions** as described by
- 2551 the TOSCA v1.0 specification.
  - 2552 ○ Note, however, that TOSCA v1.0 does not define a direction (input vs. output) for those
  - 2553 mappings, i.e. TOSCA v1.0 **PropertyMappings** are underspecified in that respect and
  - 2554 TOSCA Simple Profile's **inputs** and **outputs** provide a more concrete definition of input
  - 2555 and output parameters.

2556 **3.10 Service Template definition**

2557 A TOSCA Service Template (YAML) document contains element definitions of building blocks for cloud  
 2558 application, or complete models of cloud applications. This section describes the top-level structural  
 2559 elements (TOSCA keynames) along with their grammars, which are allowed to appear in a TOSCA  
 2560 Service Template document.

2561 **3.10.1 Keynames**

2562 The following is the list of recognized keynames for a TOSCA Service Template definition:

Keyname	Required	Type	Description
tosca_definitions_version	yes	string	Defines the version of the TOSCA Simple Profile specification the template (grammar) complies with.
namespace	no	URI	<p># illegalities: not allowed to use "tosca" namespaces (reserve tosca domains), SHOULD be unique (some guidance from XML, look to borrow)</p> <p># describe this in terms of import, by example)</p> <p># import brings in other STs into &lt;default namespace&gt;</p> <p># on collision its an error (with local type name or on same name from mult. Imports).</p> <p># Must use prefix or (full) complete name</p>

Keyname	Required	Type	Description
metadata	no	map of string	Defines a section used to declare additional metadata information. Domain-specific TOSCA profile specifications may define keynames that are required for their implementations.
description	no	description	Declares a description for this Service Template and its contents.
dsl_definitions	no	N/A	Declares optional DSL-specific definitions and conventions. For example, in YAML, this allows defining reusable YAML macros (i.e., YAML alias anchors) for use throughout the TOSCA Service Template.
repositories	no	list of Repository definitions	Declares the list of external repositories which contain artifacts that are referenced in the service template along with their addresses and necessary credential information used to connect to them in order to retrieve the artifacts.
imports	no	list of Import Definitions	Declares import statements external TOSCA Definitions documents. For example, these may be file location or URIs relative to the service template file within the same TOSCA CSAR file.
artifact_types	no	list of Artifact Types	This section contains an optional list of artifact type definitions for use in the service template
data_types	no	list of Data Types	Declares a list of optional TOSCA Data Type definitions.
capability_types	no	list of Capability Types	This section contains an optional list of capability type definitions for use in the service template.
interface_types	no	list of Interface Types	This section contains an optional list of interface type definitions for use in the service template.
relationship_types	no	list of Relationship Types	This section contains a set of relationship type definitions for use in the service template.
node_types	no	list of Node Types	This section contains a set of node type definitions for use in the service template.
group_types	no	list of Group Types	This section contains a list of group type definitions for use in the service template.
policy_types	no	list of Policy Types	This section contains a list of policy type definitions for use in the service template.
topology_template	no	Topology Template definition	Defines the topology template of an application or service, consisting of node templates that represent the application's or service's components, as well as relationship templates representing relations between the components.

### 2563 3.10.1.1 Metadata keynames

2564 The following is the list of recognized metadata keynames for a TOSCA Service Template definition:

Keyname	Required	Type	Description
template_name	no	string	Declares a descriptive name for the template.

Keyname	Required	Type	Description
template_author	no	string	Declares the author(s) or owner of the template.
template_version	no	string	Declares the version string for the template.

2565 **3.10.2 Grammar**

2566 The overall structure of a TOSCA Service Template and its top-level key collations using the TOSCA  
 2567 Simple Profile is shown below:

```
# Required TOSCA Definitions version string
tosca_definitions_version: <value> # Required, see section 3.1 for usage
namespace: <URI> # Optional, see section 3.2 for usage

# Optional metadata keyname: value pairs
metadata:
  template_name: <value> # Optional, name of this service template
  template_author: <value> # Optional, author of this service template
  template_version: <value> # Optional, version of this service template
  # Optional list of domain or profile specific metadata keynames

# Optional description of the definitions inside the file.
description: <template type description>

dsl_definitions:
  # list of YAML alias anchors (or macros)

repositories:
  # list of external repository definitions which host TOSCA artifacts

imports:
  # ordered list of import definitions

artifact_types:
  # list of artifact type definitions

data_types:
  # list of datatype definitions

capability_types:
  # list of capability type definitions

interface_types
```

```

# list of interface type definitions

relationship_types:
# list of relationship type definitions

node_types:
# list of node type definitions

group_types:
# list of group type definitions

policy_types:
# list of policy type definitions

topology_template:
# topology template definition of the cloud application or service

```

### 2568 3.10.2.1 Requirements

- 2569 • The URI value “<http://docs.oasis-open.org/tosca>”, as well as all (path) extensions to it, SHALL be
- 2570 reserved for TOSCA approved specifications and work. That means Service Templates that do
- 2571 not originate from a TOSCA approved work product MUST NOT use it, in any form, when
- 2572 declaring a (default) Namespace.
- 2573 • The key “tosca\_definitions\_version” SHOULD be the first line of each Service Template.

### 2574 3.10.2.2 Notes

- 2575 • TOSCA Service Templates do not have to contain a topology\_template and MAY contain simply
- 2576 type definitions (e.g., Artifact, Interface, Capability, Node, Relationship Types, etc.) and be
- 2577 imported for use as type definitions in other TOSCA Service Templates.

## 2578 3.10.3 Top-level keyname definitions

### 2579 3.10.3.1 tosca\_definitions\_version

2580 This required element provides a means to include a reference to the TOSCA Simple Profile specification  
2581 within the TOSCA Definitions YAML file. It is an indicator for the version of the TOSCA grammar that  
2582 should be used to parse the remainder of the document.

#### 2583 3.10.3.1.1 Keyname

```
tosca_definitions_version
```

#### 2584 3.10.3.1.2 Grammar

2585 Single-line form:

```
tosca_definitions_version: <tosca_simple_profile_version>
```

### 2586 **3.10.3.1.3 Examples:**

2587 TOSCA Simple Profile version 1.0 specification using the defined namespace alias (see Section 3.1):

```
tosca_definitions_version: toasca_simple_yaml_1_0
```

2588 TOSCA Simple Profile version 1.0 specification using the fully defined (target) namespace (see Section  
2589 3.1):

```
tosca_definitions_version: http://docs.oasis-open.org/tosca/ns/simple/yaml/1.0
```

### 2590 **3.10.3.2 metadata**

2591 This keyname is used to associate domain-specific metadata with the Service Template. The metadata  
2592 keyname allows a declaration of a map of keynames with string values.

#### 2593 **3.10.3.2.1 Keyname**

```
metadata
```

#### 2594 **3.10.3.2.2 Grammar**

```
metadata:  
  <map_of_string_values>
```

#### 2595 **3.10.3.2.3 Example**

```
metadata:  
  creation_date: 2015-04-14  
  date_updated: 2015-05-01  
  status: developmental
```

2596

### 2597 **3.10.3.3 template\_name**

2598 This optional metadata keyname can be used to declare the name of service template as a single-line  
2599 string value.

#### 2600 **3.10.3.3.1 Keyname**

```
template_name
```

#### 2601 **3.10.3.3.2 Grammar**

```
template_name: <name string>
```



2602 **3.10.3.3.3 Example**

```
template_name: My service template
```

2603 **3.10.3.3.4 Notes**

- 2604
- Some service templates are designed to be referenced and reused by other service templates. Therefore, in these cases, the `template_name` value SHOULD be designed to be used as a unique identifier through the use of namespacing techniques.
- 2605
- 2606

2607 **3.10.3.4 template\_author**

2608 This optional metadata keyname can be used to declare the author(s) of the service template as a single-line string value.

2609

2610 **3.10.3.4.1 Keyname**

```
template_author
```

2611 **3.10.3.4.2 Grammar**

```
template_author: <author string>
```

2612 **3.10.3.4.3 Example**

```
template_author: My service template
```

2613 **3.10.3.5 template\_version**

2614 This optional metadata keyname can be used to declare a domain specific version of the service template as a single-line string value.

2615

2616 **3.10.3.5.1 Keyname**

```
template_version
```

2617 **3.10.3.5.2 Grammar**

```
template_version: <version>
```

2618 **3.10.3.5.3 Example**

```
template_version: 2.0.17
```

2619 **3.10.3.5.4 Notes:**

- 2620
- Some service templates are designed to be referenced and reused by other service templates and have a lifecycle of their own. Therefore, in these cases, a `template_version` value SHOULD be included and used in conjunction with a unique `template_name` value to enable lifecycle management of the service template and its contents.
- 2621
- 2622
- 2623

2624 **3.10.3.6 description**

2625 This optional keyname provides a means to include single or multiline descriptions within a TOSCA  
2626 Simple Profile template as a scalar string value.

2627 **3.10.3.6.1 Keyname**

```
description
```

2628 **3.10.3.7 dsl\_definitions**

2629 This optional keyname provides a section to define macros (e.g., YAML-style macros when using the  
2630 TOSCA Simple Profile in YAML specification).

2631 **3.10.3.7.1 Keyname**

```
dsl_definitions
```

2632 **3.10.3.7.2 Grammar**

```
dsl_definitions:  
  <dsl_definition_1>  
  ...  
  <dsl_definition_n>
```

2633 **3.10.3.7.3 Example**

```
dsl_definitions:  
  ubuntu_image_props: &ubuntu_image_props  
    architecture: x86_64  
    type: linux  
    distribution: ubuntu  
    os_version: 14.04  
  
  redhat_image_props: &redhat_image_props  
    architecture: x86_64  
    type: linux  
    distribution: rhel  
    os_version: 6.6
```

2634 **3.10.3.8 repositories**

2635 This optional keyname provides a section to define external repositories which may contain artifacts or  
2636 other TOSCA Service Templates which might be referenced or imported by the TOSCA Service Template  
2637 definition.

### 2638 3.10.3.8.1 Keyname

```
repositories
```

### 2639 3.10.3.8.2 Grammar

```
repositories:  
  <repository_definition 1>  
  ...  
  <repository_definition n>
```

### 2640 3.10.3.8.3 Example

```
repositories:  
  my_project_artifact_repo:  
    description: development repository for TAR archives and Bash scripts  
    url: http://mycompany.com/repository/myproject/
```

### 2641 3.10.3.9 imports

2642 This optional keyname provides a way to import a *block sequence* of one or more TOSCA Definitions  
2643 documents. TOSCA Definitions documents can contain reusable TOSCA type definitions (e.g., Node  
2644 Types, Relationship Types, Artifact Types, etc.) defined by other authors. This mechanism provides an  
2645 effective way for companies and organizations to define normative types and/or describe their software  
2646 applications for reuse in other TOSCA Service Templates.

### 2647 3.10.3.9.1 Keyname

```
imports
```

### 2648 3.10.3.9.2 Grammar

```
imports:  
  - <import_definition 1>  
  - ...  
  - <import_definition n>
```

### 2649 3.10.3.9.3 Example

```
# An example import of definitions files from a location relative to the  
# file location of the service template declaring the import.  
imports:  
  - some_definitions: relative_path/my_defns/my_typesdefs_1.yaml  
  - file: my_defns/my_typesdefs_n.yaml  
    repository: my_company_repo  
    namespace_prefix: mycompany
```

2650 **artifact\_types**

2651 This optional keyname lists the Artifact Types that are defined by this Service Template.

2652 **3.10.3.9.4 Keyname**

```
artifact_types
```

2653 **3.10.3.9.5 Grammar**

```
artifact_types:  
  <artifact_type_defn_1>  
  ...  
  <artifact_type_defn_n>
```

2654 **3.10.3.9.6 Example**

```
artifact_types:  
  mycompany.artifacttypes.myFileType:  
    derived_from: tosca.artifacts.File
```

2655 **3.10.3.10 data\_types**

2656 This optional keyname provides a section to define new data types in TOSCA.

2657 **3.10.3.10.1 Keyname**

```
data_types
```

2658 **3.10.3.10.2 Grammar**

```
data_types:  
  <tosca_datatype_def_1>  
  ...  
  <tosca_datatype_def_n>
```

2659 **3.10.3.10.3 Example**

```
data_types:  
  # A complex datatype definition  
  simple_contactinfo_type:  
    properties:  
      name:  
        type: string  
      email:  
        type: string
```

```

    phone:
      type: string

# datatype definition derived from an existing type
full_contact_info:
  derived_from: simple_contact_info
  properties:
    street_address:
      type: string
    city:
      type: string
    state:
      type: string
    postalcode:
      type: string

```

### 2660 3.10.3.11 capability\_types

2661 This optional keyname lists the Capability Types that provide the reusable type definitions that can be  
 2662 used to describe features Node Templates or Node Types can declare they support.

#### 2663 3.10.3.11.1 Keyname

```
capability_types
```

#### 2664 3.10.3.11.2 Grammar

```

capability_types:
  <capability type defn 1>
  ...
  <capability type defn n>

```

#### 2665 3.10.3.11.3 Example

```

capability_types:
  mycompany.mytypes.myCustomEndpoint:
    derived_from: toska.capabilities.Endpoint
    properties:
      # more details ...

  mycompany.mytypes.myCustomFeature:
    derived_from: toska.capabilities.Feature
    properties:
      # more details ...

```

2666 **3.10.3.12 interface\_types**

2667 This optional keyname lists the Interface Types that provide the reusable type definitions that can be used  
2668 to describe operations for on TOSCA entities such as Relationship Types and Node Types.

2669 **3.10.3.12.1 Keyname**

```
interface_types
```

2670 **3.10.3.12.2 Grammar**

```
interface_types:  
  <interface type defn 1>  
  ...  
  <interface type defn n>
```

2671 **3.10.3.12.3 Example**

```
interface_types:  
  mycompany.interfaces.service.Signal:  
    signal_begin_receive:  
      description: Operation to signal start of some message processing.  
    signal_end_receive:  
      description: Operation to signal end of some message processed.
```

2672 **3.10.3.13 relationship\_types**

2673 This optional keyname lists the Relationship Types that provide the reusable type definitions that can be  
2674 used to describe dependent relationships between Node Templates or Node Types.

2675 **3.10.3.13.1 Keyname**

```
relationship_types
```

2676 **3.10.3.13.2 Grammar**

```
relationship_types:  
  <relationship type defn 1>  
  ...  
  <relationship type defn n>
```

2677 **3.10.3.13.3 Example**

```
relationship_types:  
  mycompany.mytypes.myCustomClientServerType:  
    derived_from: toska.relationships.HostedOn  
    properties:
```

```
# more details ...

mycompany.mytypes.myCustomConnectionType:
  derived_from: toscarelationships.ConnectsTo
  properties:
    # more details ...
```

### 2678 3.10.3.14 node\_types

2679 This optional keyname lists the Node Types that provide the reusable type definitions for software  
2680 components that Node Templates can be based upon.

#### 2681 3.10.3.14.1 Keyname

```
node_types
```

#### 2682 3.10.3.14.2 Grammar

```
node_types:
  <node_type_defn_1>
  ...
  <node_type_defn_n>
```

#### 2683 3.10.3.14.3 Example

```
node_types:
  my_webapp_node_type:
    derived_from: WebApplication
    properties:
      my_port:
        type: integer

  my_database_node_type:
    derived_from: Database
    capabilities:
      mytypes.myfeatures.transactSQL
```

#### 2684 3.10.3.14.4 Notes

- 2685
- The node types listed as part of the **node\_types** block can be mapped to the list of **NodeType**  
2686 definitions as described by the TOSCA v1.0 specification.

### 2687 3.10.3.15 group\_types

2688 This optional keyname lists the Group Types that are defined by this Service Template.

2689 **3.10.3.15.1 Keyname**

```
group_types
```

2690 **3.10.3.15.2 Grammar**

```
group_types:  
  <group_type_defn_1>  
  ...  
  <group_type_defn_n>
```

2691 **3.10.3.15.3 Example**

```
group_types:  
  mycompany.mytypes.myScalingGroup:  
    derived_from: toscagroups.Root
```

2692 **3.10.3.16 policy\_types**

2693 This optional keyname lists the Policy Types that are defined by this Service Template.

2694 **3.10.3.16.1 Keyname**

```
policy_types
```

2695 **3.10.3.16.2 Grammar**

```
policy_types:  
  <policy_type_defn_1>  
  ...  
  <policy_type_defn_n>
```

2696 **3.10.3.16.3 Example**

```
policy_types:  
  mycompany.mytypes.myScalingPolicy:  
    derived_from: toscapolicies.Scaling
```



2697

## 4 TOSCA functions

2698 Except for the examples, this section is **normative** and includes functions that are supported for use  
2699 within a TOSCA Service Template.

### 4.1 Reserved Function Keywords

2701 The following keywords MAY be used in some TOSCA function in place of a TOSCA Node or  
2702 Relationship Template name. A TOSCA orchestrator will interpret them at the time the function would be  
2703 evaluated at runtime as described in the table below. Note that some keywords are only valid in the  
2704 context of a certain TOSCA entity as also denoted in the table.

2705

Keyword	Valid Contexts	Description
SELF	Node Template or Relationship Template	A TOSCA orchestrator will interpret this keyword as the Node or Relationship Template instance that contains the function at the time the function is evaluated.
SOURCE	Relationship Template only.	A TOSCA orchestrator will interpret this keyword as the Node Template instance that is at the source end of the relationship that contains the referencing function.
TARGET	Relationship Template only.	A TOSCA orchestrator will interpret this keyword as the Node Template instance that is at the target end of the relationship that contains the referencing function.
HOST	Node Template only	A TOSCA orchestrator will interpret this keyword to refer to the all nodes that "host" the node using this reference (i.e., as identified by its HostedOn relationship).  Specifically, TOSCA orchestrators that encounter this keyword when evaluating the <b>get_attribute</b> or <b>get_property</b> functions SHALL search each node along the "HostedOn" relationship chain starting at the immediate node that hosts the node where the function was evaluated (and then that node's host node, and so forth) until a match is found or the "HostedOn" relationship chain ends.

2706

### 4.2 Environment Variable Conventions

#### 4.2.1 Reserved Environment Variable Names and Usage

2709 TOSCA orchestrators utilize certain reserved keywords in the execution environments that  
2710 implementation artifacts for Node or Relationship Templates operations are executed in. They are used to  
2711 provide information to these implementation artifacts such as the results of TOSCA function evaluation or  
2712 information about the instance model of the TOSCA application

2713

2714 The following keywords are reserved environment variable names in any TOSCA supported execution  
2715 environment:

Keyword	Valid Contexts	Description
TARGETS	Relationship Template only.	<ul style="list-style-type: none"> <li>For an implementation artifact that is executed in the context of a relationship, this keyword, if present, is used to supply a list of Node Template instances in a TOSCA application's instance model that are currently target of the context relationship.</li> <li>The value of this environment variable will be a comma-separated list of identifiers of the single target node instances (i.e., the <b>tosca_id</b> attribute of the node).</li> </ul>
TARGET	Relationship Template only.	<ul style="list-style-type: none"> <li>For an implementation artifact that is executed in the context of a relationship, this keyword, if present, identifies a Node Template instance in a TOSCA application's instance model that is a target of the context relationship, and which is being acted upon in the current operation.</li> <li>The value of this environment variable will be the identifier of the single target node instance (i.e., the <b>tosca_id</b> attribute of the node).</li> </ul>
SOURCES	Relationship Template only.	<ul style="list-style-type: none"> <li>For an implementation artifact that is executed in the context of a relationship, this keyword, if present, is used to supply a list of Node Template instances in a TOSCA application's instance model that are currently source of the context relationship.</li> <li>The value of this environment variable will be a comma-separated list of identifiers of the single source node instances (i.e., the <b>tosca_id</b> attribute of the node).</li> </ul>
SOURCE	Relationship Template only.	<ul style="list-style-type: none"> <li>For an implementation artifact that is executed in the context of a relationship, this keyword, if present, identifies a Node Template instance in a TOSCA application's instance model that is a source of the context relationship, and which is being acted upon in the current operation.</li> <li>The value of this environment variable will be the identifier of the single source node instance (i.e., the <b>tosca_id</b> attribute of the node).</li> </ul>

2716

2717 For scripts (or implementation artifacts in general) that run in the context of relationship operations, select  
 2718 properties and attributes of both the relationship itself as well as select properties and attributes of the  
 2719 source and target node(s) of the relationship can be provided to the environment by declaring respective  
 2720 operation inputs.

2721

2722 Declared inputs from mapped properties or attributes of the source or target node (selected via the  
 2723 **SOURCE** or **TARGET** keyword) will be provided to the environment as variables having the exact same name  
 2724 as the inputs. In addition, the same values will be provided for the complete set of source or target nodes,  
 2725 however prefixed with the ID if the respective nodes. By means of the **SOURCES** or **TARGETS** variables  
 2726 holding the complete set of source or target node IDs, scripts will be able to iterate over corresponding  
 2727 inputs for each provided ID prefix.

2728

2729 The following example snippet shows an imaginary relationship definition from a load-balancer node to  
 2730 worker nodes. A script is defined for the **add\_target** operation of the Configure interface of the  
 2731 relationship, and the **ip\_address** attribute of the target is specified as input to the script:

2732

```
node_templates:
  load_balancer:
    type: some.vendor.LoadBalancer
```

```

requirements:
  - member:
      relationship: some.vendor.LoadBalancerToMember
      interfaces:
        Configure:
          add_target:
            inputs:
              member_ip: { get_attribute: [ TARGET, ip_address ] }
            implementation: scripts/configure_members.py

```

2733 The **add\_target** operation will be invoked, whenever a new target member is being added to the load-  
 2734 balancer. With the above inputs declaration, a **member\_ip** environment variable that will hold the IP  
 2735 address of the target being added will be provided to the **configure\_members.py** script. In addition, the  
 2736 IP addresses of all current load-balancer members will be provided as environment variables with a  
 2737 naming scheme of **<target node ID>\_member\_ip**. This will allow, for example, scripts that always just  
 2738 write the complete list of load-balancer members into a configuration file to do so instead of updating  
 2739 existing list, which might be more complicated.

2740 Assuming that the TOSCA application instance includes five load-balancer members, **node1** through  
 2741 **node5**, where **node5** is the current target being added, the following environment variables (plus  
 2742 potentially more variables) would be provided to the script:

```

# the ID of the current target and the IDs of all targets
TARGET=node5
TARGETS=node1,node2,node3,node4,node5

# the input for the current target and the inputs of all targets
member_ip=10.0.0.5
node1_member_ip=10.0.0.1
node2_member_ip=10.0.0.2
node3_member_ip=10.0.0.3
node4_member_ip=10.0.0.4
node5_member_ip=10.0.0.5

```

2743 With code like shown in the snippet below, scripts could then iterate of all provided **member\_ip** inputs:

```

#!/usr/bin/python
import os

targets = os.environ['TARGETS'].split(',')

for t in targets:
    target_ip = os.environ.get('%s_member_ip' % t)
    # do something with target_ip ...

```

2744 **4.2.2 Prefixed vs. Unprefixed TARGET names**

2745 The list target node types assigned to the TARGETS key in an execution environment would have names  
2746 prefixed by unique IDs that distinguish different instances of a node in a running model Future drafts of  
2747 this specification will show examples of how these names/IDs will be expressed.

2748 **4.2.2.1 Notes**

- 2749 • Target of interest is always un-prefixed. Prefix is the target opaque ID. The IDs can be used to  
2750 find the environment var. for the corresponding target. Need an example here.
- 2751 • If you have one node that contains multiple targets this would also be used (add or remove target  
2752 operations would also use this you would get set of all current targets).

2753 **4.3 Intrinsic functions**

2754 These functions are supported within the TOSCA template for manipulation of template data.

2755 **4.3.1 concat**

2756 The **concat** function is used to concatenate two or more string values within a TOSCA service template.

2757 **4.3.1.1 Grammar**

```
concat: [<string_value_expressions_*> ]
```

2758 **4.3.1.2 Parameters**

Parameter	Required	Type	Description
<string_value_expressions_*>	yes	list of <a href="#">string</a> or <a href="#">string</a> value expressions	A list of one or more strings (or expressions that result in a string value) which can be concatenated together into a single string.

2759 **4.3.1.3 Examples**

```
outputs:
  description: Concatenate the URL for a server from other template values
  server_url:
    value: { concat: [ 'http://',
                      get_attribute: [ server, public_address ],
                      ':',
                      get_attribute: [ server, port ] ] }
```

2760 **4.3.2 join**

2761 The **join** function is used to join an array of strings into a single string with optional delimiter.

2762 **4.3.2.1 Grammar**

```
join: [<list of string_value_expressions_*> [ <delimiter> ] ]
```

2763 **4.3.2.2 Parameters**

Parameter	Required	Type	Description
<list string_value_expressions_*>	yes	list of <a href="#">string</a> or <a href="#">string</a> value expressions	A list of one or more strings (or expressions that result in a list of string values) which can be joined together into a single string.
<delimiter>	no	string	An optional delimiter used to join the string in the provided list.

2764 **4.3.2.3 Examples**

```

outputs:
  example1:
    # Result: prefix_1111_suffix
    value: { join: [ ["prefix", 1111, "suffix" ], "_" ] }
  example2:
    # Result: 9.12.1.10,9.12.1.20
    value: { join: [ { get_input: my_IPs }, "," ] }

```

2765 **4.3.3 token**

2766 The **token** function is used within a TOSCA service template on a string to parse out (tokenize)  
 2767 substrings separated by one or more token characters within a larger string.

2768 **4.3.3.1 Grammar**

```

token: [ <string_with_tokens>, <string_of_token_chars>, <substring_index> ]

```

2769 **4.3.3.2 Parameters**

Parameter	Required	Type	Description
string_with_tokens	yes	<a href="#">string</a>	The composite string that contains one or more substrings separated by token characters.
string_of_token_chars	yes	<a href="#">string</a>	The string that contains one or more token characters that separate substrings within the composite string.
substring_index	yes	<a href="#">integer</a>	The integer indicates the index of the substring to return from the composite string. Note that the first substring is denoted by using the '0' (zero) integer value.

2770 **4.3.3.3 Examples**

```

outputs:
  webserver_port:
    description: the port provided at the end of my server's endpoint's IP address
    value: { token: [ get_attribute: [ my_server, data_endpoint, ip_address ],
                    ':',

```

## 2771 4.4 Property functions

2772 These functions are used within a service template to obtain property values from property definitions  
 2773 declared elsewhere in the same service template. These property definitions can appear either directly in  
 2774 the service template itself (e.g., in the inputs section) or on entities (e.g., node or relationship templates)  
 2775 that have been modeled within the template.

2776

2777 Note that the **get\_input** and **get\_property** functions may only retrieve the static values of property  
 2778 definitions of a TOSCA application as defined in the TOSCA Service Template. The **get\_attribute**  
 2779 function should be used to retrieve values for attribute definitions (or property definitions reflected as  
 2780 attribute definitions) from the runtime instance model of the TOSCA application (as realized by the  
 2781 TOSCA orchestrator).

### 2782 4.4.1 get\_input

2783 The **get\_input** function is used to retrieve the values of properties declared within the **inputs** section of  
 2784 a TOSCA Service Template.

#### 2785 4.4.1.1 Grammar

```
get_input: <input_property_name>
```

#### 2786 4.4.1.2 Parameters

Parameter	Required	Type	Description
<input_property_name>	yes	string	The name of the property as defined in the inputs section of the service template.

#### 2787 4.4.1.3 Examples

```
inputs:
  cpus:
    type: integer

node_templates:
  my_server:
    type: toska.nodes.Compute
    capabilities:
      host:
        properties:
          num_cpus: { get_input: cpus }
```

### 2788 4.4.2 get\_property

2789 The **get\_property** function is used to retrieve property values between modelable entities defined in the  
 2790 same service template.

2791 **4.4.2.1 Grammar**

```
get_property: [ <modelable_entity_name>, <optional_req_or_cap_name>,
<property_name>, <nested_property_name_or_index_1>, ...,
<nested_property_name_or_index_n> ]
```

2792 **4.4.2.2 Parameters**

Parameter	Required	Type	Description
<modelable entity name>   SELF   SOURCE   TARGET   HOST	yes	string	The required name of a modelable entity (e.g., Node Template or Relationship Template name) as declared in the service template that contains the named property definition the function will return the value from. See section B.1 for valid keywords.
<optional_req_or_cap_name>	no	string	The optional name of the requirement or capability name within the modelable entity (i.e., the <modelable_entity_name> which contains the named property definition the function will return the value from.  <b>Note:</b> If the property definition is located in the modelable entity directly, then this parameter MAY be omitted.
<property_name>	yes	string	The name of the property definition the function will return the value from.
<nested_property_name_or_index_*>	no	string   integer	Some TOSCA properties are complex (i.e., composed as nested structures). These parameters are used to dereference into the names of these nested structures when needed.  Some properties represent <b>list</b> types. In these cases, an index may be provided to reference a specific entry in the list (as named in the previous parameter) to return.

2793 **4.4.2.3 Examples**

2794 The following example shows how to use the **get\_property** function with an actual Node Template  
2795 name:

```
node_templates:

mysql_database:
  type: tosca.nodes.Database
  properties:
    name: sql_database1

wordpress:
  type: tosca.nodes.WebApplication.WordPress
  ...
  interfaces:
    Standard:
      configure:
        inputs:
```

```
wp_db_name: { get_property: [ mysql_database, name ] }
```

2796 The following example shows how to use the `get_property` function using the `SELF` keyword:

```
node_templates:  
  
  mysql_database:  
    type: tosca.nodes.Database  
    ...  
    capabilities:  
      database_endpoint:  
        properties:  
          port: 3306  
  
  wordpress:  
    type: tosca.nodes.WebApplication.WordPress  
    requirements:  
      ...  
      - database_endpoint: mysql_database  
    interfaces:  
      Standard:  
        create: wordpress_install.sh  
        configure:  
          implementation: wordpress_configure.sh  
        inputs:  
          ...  
          wp_db_port: { get_property: [ SELF, database_endpoint, port ] }
```

2797 The following example shows how to use the `get_property` function using the `TARGET` keyword:

```
relationship_templates:  
  my_connection:  
    type: ConnectsTo  
    interfaces:  
      Configure:  
        inputs:  
          targets_value: { get_property: [ TARGET, value ] }
```

## 2798 4.5 Attribute functions

2799 These functions (attribute functions) are used within an instance model to obtain attribute values from  
2800 instances of nodes and relationships that have been created from an application model described in a  
2801 service template. The instances of nodes or relationships can be referenced by their name as assigned  
2802 in the service template or relative to the context where they are being invoked.



2803 **4.5.1 get\_attribute**

2804 The `get_attribute` function is used to retrieve the values of named attributes declared by the  
 2805 referenced node or relationship template name.

2806 **4.5.1.1 Grammar**

```
get_attribute: [ <modelable_entity_name>, <optional_req_or_cap_name>,
<attribute_name>, <nested_attribute_name_or_index_1>, ...,
<nested_attribute_name_or_index_n> ]
```

2807 **4.5.1.2 Parameters**

Parameter	Required	Type	Description
<modelable_entity_name>   SELF   SOURCE   TARGET   HOST	yes	string	The required name of a modelable entity (e.g., Node Template or Relationship Template name) as declared in the service template that contains the named attribute definition the function will return the value from. See section B.1 for valid keywords.
<optional_req_or_cap_name>	no	string	The optional name of the requirement or capability name within the modelable entity (i.e., the <modelable_entity_name> which contains the named attribute definition the function will return the value from.  <b>Note:</b> If the attribute definition is located in the modelable entity directly, then this parameter MAY be omitted.
<attribute_name>	yes	string	The name of the attribute definition the function will return the value from.
<nested_attribute_name_or_index_*>	no	string   integer	Some TOSCA attributes are complex (i.e., composed as nested structures). These parameters are used to dereference into the names of these nested structures when needed.  Some attributes represent <b>list</b> types. In these cases, an index may be provided to reference a specific entry in the list (as named in the previous parameter) to return.

2808 **4.5.1.3 Examples:**

2809 The attribute functions are used in the same way as the equivalent Property functions described above.  
 2810 Please see their examples and replace “get\_property” with “get\_attribute” function name.

2811 **4.5.1.4 Notes**

2812 These functions are used to obtain attributes from instances of node or relationship templates by the  
 2813 names they were given within the service template that described the application model (pattern).

- 2814 • These functions only work when the orchestrator can resolve to a single node or relationship  
 2815 instance for the named node or relationship. This essentially means this is acknowledged to work  
 2816 only when the node or relationship template being referenced from the service template has a  
 2817 cardinality of 1 (i.e., there can only be one instance of it running).

2818 **4.6 Operation functions**

2819 These functions are used within an instance model to obtain values from interface operations. These can  
2820 be used in order to set an attribute of a node instance at runtime or to pass values from one operation to  
2821 another.

2822 **4.6.1 get\_operation\_output**

2823 The **get\_operation\_output** function is used to retrieve the values of variables exposed / exported from  
2824 an interface operation.

2825 **4.6.1.1 Grammar**

```
get_operation_output: <modelable_entity_name>, <interface_name>,  
<operation_name>, <output_variable_name>
```

2826 **4.6.1.2 Parameters**

Parameter	Required	Type	Description
<modelable_entity_name>   SELF   SOURCE   TARGET	yes	string	The required name of a modelable entity (e.g., Node Template or Relationship Template name) as declared in the service template that implements the named interface and operation.
<interface_name>	Yes	string	The required name of the interface which defines the operation.
<operation_name>	yes	string	The required name of the operation whose value we would like to retrieve.
<output_variable_name>	Yes	string	The required name of the variable that is exposed / exported by the operation.

2827 **4.6.1.3 Notes**

- 2828
- If operation failed, then ignore its outputs. Orchestrators should allow orchestrators to continue running when possible past deployment in the lifecycle. For example, if an update fails, the application should be allowed to continue running and some other method would be used to alert administrators of the failure.
- 2829  
2830  
2831

2832 **4.7 Navigation functions**

- 2833
- This version of the TOSCA Simple Profile does not define any model navigation functions.

2834 **4.7.1 get\_nodes\_of\_type**

2835 The **get\_nodes\_of\_type** function can be used to retrieve a list of all known instances of nodes of the  
2836 declared Node Type.

2837 **4.7.1.1 Grammar**

```
get_nodes_of_type: <node_type_name>
```

2838 **4.7.1.2 Parameters**

Parameter	Required	Type	Description
<node_type_name>	yes	string	The required name of a Node Type that a TOSCA orchestrator would use to search a running application instance in order to return all unique, named node instances of that type.

2839 **4.7.1.3 Returns**

Return Key	Type	Description
TARGETS	<see above>	The list of node instances from the current application instance that match the <b>node_type_name</b> supplied as an input parameter of this function.

2840 **4.8 Artifact functions**

2841 **4.8.1 get\_artifact**

2842 The **get\_artifact** function is used to retrieve artifact location between modelable entities defined in the  
 2843 same service template.

2844 **4.8.1.1 Grammar**

```
get_artifact: [ <modelable_entity_name>, <artifact_name>, <location>, <remove> ]
```

2845 **4.8.1.2 Parameters**

Parameter	Required	Type	Description
<modelable entity name>   SELF   SOURCE   TARGET   HOST	yes	string	The required name of a modelable entity (e.g., Node Template or Relationship Template name) as declared in the service template that contains the named property definition the function will return the value from. See section B.1 for valid keywords.
<artifact_name>	yes	string	The name of the artifact definition the function will return the value from.
<location>   LOCAL_FILE	no	string	Location value must be either a valid path e.g. '/etc/var/my_file' or ' <b>LOCAL_FILE</b> '.  If the value is LOCAL_FILE the orchestrator is responsible for providing a path as the result of the <b>get_artifact</b> call where the artifact file can be accessed. The orchestrator will also remove the artifact from this location at the end of the operation.  If the location is a path specified by the user the orchestrator is responsible to copy the artifact to the specified location. The orchestrator will return the path as the value of the <b>get_artifact</b> function and leave the file here after the execution of the operation.

Parameter	Required	Type	Description
remove	no	boolean	<p>Boolean flag to override the orchestrator default behavior so it will remove or not the artifact at the end of the operation execution.</p> <p>If not specified the removal will depends of the location e.g. removes it in case of 'LOCAL_FILE' and keeps it in case of a path.</p> <p>If true the artifact will be removed by the orchestrator at the end of the operation execution, if false it will not be removed.</p>

### 2846 4.8.1.3 Examples

2847 The following example uses a snippet of a WordPress [WordPress] web application to show how to use  
 2848 the `get_artifact` function with an actual Node Template name:

#### 2849 4.8.1.3.1 Example: Retrieving artifact without specified location

```
node_templates:

  wordpress:
    type: tosca.nodes.WebApplication.WordPress
    ...
    interfaces:
      Standard:
        configure:
        create:
          implementation: wordpress_install.sh
        inputs
          wp_zip: { get_artifact: [ SELF, zip ] }
    artifacts:
      zip: /data/wordpress.zip
```

2850 In such implementation the TOSCA orchestrator may provide the **wordpress.zip** archive as

- 2851 • a local URL (example: `file://home/user/wordpress.zip`) or
- 2852 • a remote one (example: `http://cloudrepo:80/files/wordpress.zip`) where some orchestrator
- 2853 may indeed provide some global artifact repository management features.

#### 2854 4.8.1.3.2 Example: Retrieving artifact as a local path

2855 The following example explains how to force the orchestrator to copy the file locally before calling the  
 2856 operation's implementation script:

2857

```
node_templates:

  wordpress:
    type: tosca.nodes.WebApplication.WordPress
```

```

...
interfaces:
  Standard:
    configure:
    create:
      implementation: wordpress_install.sh
    inputs
      wp_zip: { get_artifact: [ SELF, zip, LOCAL_FILE ] }
artifacts:
  zip: /data/wordpress.zip

```

2858 In such implementation the TOSCA orchestrator must provide the wordpress.zip archive as a local path  
 2859 (example: [/tmp/wordpress.zip](#)) and **will remove it** after the operation is completed.

### 2860 4.8.1.3.3 Example: Retrieving artifact in a specified location

2861 The following example explains how to force the orchestrator to copy the file locally to a specific location  
 2862 before calling the operation's implementation script :

2863

```

node_templates:

wordpress:
  type: tosca.nodes.WebApplication.WordPress
  ...
  interfaces:
    Standard:
      configure:
      create:
        implementation: wordpress_install.sh
      inputs
        wp_zip: { get_artifact: [ SELF, zip, C:/wpdata/wp.zip ] }
  artifacts:
    zip: /data/wordpress.zip

```

2864 In such implementation the TOSCA orchestrator must provide the wordpress.zip archive as a local path  
 2865 (example: [C:/wpdata/wp.zip](#)) and **will let it** after the operation is completed.

## 2866 4.9 Context-based Entity names (global)

2867 Future versions of this specification will address methods to access entity names based upon the context  
 2868 in which they are declared or defined.

### 2869 4.9.1.1 Goals

- 2870 • Using the full paths of modelable entity names to qualify context with the future goal of a more  
 2871 robust get\_attribute function: e.g., get\_attribute( <context-based-entity-name>, <attribute name>)

---

## 2872 5 TOSCA normative type definitions

2873 Except for the examples, this section is **normative** and contains normative type definitions which  
2874 must be supported for conformance to this specification.

2875

2876 The declarative approach is heavily dependent of the definition of basic types that a declarative  
2877 container must understand. The definition of these types must be very clear such that the  
2878 operational semantics can be precisely followed by a declarative container to achieve the effects  
2879 intended by the modeler of a topology in an interoperable manner.

### 2880 5.1 Assumptions

- 2881 • Assumes alignment with/dependence on XML normative types proposal for TOSCA v1.1
- 2882 • Assumes that the normative types will be versioned and the TOSCA TC will preserve backwards  
2883 compatibility.
- 2884 • Assumes that security and access control will be addressed in future revisions or versions of this  
2885 specification.

### 2886 5.2 TOSCA normative type names

2887 Every normative type has three names declared:

- 2888 1. **Type URI** – This is the unique identifying name for the type.  
2889 a. These are reserved names within the TOSCA namespace.
- 2890 2. **Shorthand Name** – This is the shorter (simpler) name that can be used in place of its  
2891 corresponding, full **Type URI** name.  
2892 a. These are reserved names within TOSCA namespace that MAY be used in place of the  
2893 full Type URI.  
2894 b. Profiles of the OASIS TOSCA Simple Profile specification SHALL assure non-collision of  
2895 names for new types when they are introduced.  
2896 c. TOSCA type designers SHOULD NOT create new types with names that would collide  
2897 with any TOSCA normative type Shorthand Name.
- 2898 3. **Type Qualified Name** – This is a modified **Shorthand Name** that includes the “**tosca:**”  
2899 namespace prefix which clearly qualifies it as being part of the TOSCA namespace.  
2900 a. This name MAY be used to assure there is no collision when types are imported from  
2901 other (non) TOSCA approved sources.

#### 2902 5.2.1 Additional requirements

- 2903 • **Case sensitivity** - TOSCA Type URI, Shorthand and Type Qualified names SHALL be treated as  
2904 case sensitive.
  - 2905 ○ The case of each type name has been carefully selected by the TOSCA working group  
2906 and TOSCA orchestrators and processors SHALL strictly recognize the name casing as  
2907 specified in this specification or any of its approved profiles.

### 2908 5.3 Data Types

#### 2909 5.3.1 `tosca.datatypes.Root`

2910 This is the default (root) TOSCA Root Type definition that all complex TOSCA Data Types derive from.

2911 **5.3.1.1 Definition**

2912 The TOSCA Root type is defined as follows:

```
tosca.datatypes.Root:
  description: The TOSCA root Data Type all other TOSCA base Data Types derive
  from
```

2913 **5.3.2 tosca.datatypes.json**

2914 The json type is a TOSCA data Type used to define a string that containst data in the JavaScript Object  
2915 Notation (JSON) format.

2916

<b>Shorthand Name</b>	json
<b>Type Qualified Name</b>	tosca:json
<b>Type URI</b>	tosca.datatypes.json

2917 **5.3.2.1 Definition**

2918 The json type is defined as follows:

```
tosca.datatypes.json:
  derived_from: string
```

2919 **5.3.2.2 Examples**

2920 **5.3.2.2.1 Type declaration example**

2921 Simple declaration of an 'event\_object' property declared to be a 'json' data type with its associated  
2922 JSON Schema:

```
properties:
  event_object:
    type: json
    constraints:
      schema: >
        {
          "$schema": "http://json-schema.org/draft-04/schema#",
          "title": "Event",
          "description": "Example Event type schema",
          "type": "object",
          "properties": {
            "uuid": {
              "description": "The unique ID for the event.",
              "type": "string"
            },
          },
          "code": {
```

```

        "type": "integer"
      },
      "message": {
        "type": "string"
      }
    },
    "required": ["uuid", "code"]
  }

```

2923

### 2924 5.3.2.2.2 Template definition example

2925 This example shows a valid JSON datatype value for the 'event\_object' schema declare in the previous  
 2926 example.

```

# properties snippet from a TOSCA template definition.
properties:
  event_object: <
    {
      "uuid": "cadf:1234-56-0000-abcd",
      "code": 9876
    }

```

### 2927 5.3.3 Additional Requirements

- 2928 • The json datatype SHOULD only be assigned string values that contain valid JSON syntax as  
 2929 defined by the "The JSON Data Interchange Format Standard" (see reference **[JSON-Spec]**).

### 2930 5.3.4 tosca.datatypes.xml

2931 The xml type is a TOSCA data Type used to define a string that containst data in the Extensible Markup  
 2932 Language (XML) format.

<b>Shorthand Name</b>	xml
<b>Type Qualified Name</b>	tosca:xml
<b>Type URI</b>	tosca.datatypes.xml

#### 2933 5.3.4.1 Definition

2934 The xml type is defined as follows:

```

tosca.datatypes.xml:
  derived_from: string

```



2935 **5.3.4.2 Examples**

2936 **5.3.4.2.1 Type declaration example**

2937 Simple declaration of an 'event\_object' property declared to be an 'xml' data type with its associated XML  
2938 Schema:

```
properties:
  event_object:
    type: xml
    constraints:
      schema: >
        <xs:schema xmlns:xs="http://www.w3.org/2001/XMLSchema"
          targetNamespace="http://cloudplatform.org/events.xsd"
          xmlns="http://tempuri.org/po.xsd" elementFormDefault="qualified">
          <xs:annotation>
            <xs:documentation xml:lang="en">
              Event object.
            </xs:documentation>
          </xs:annotation>
          <xs:element name="eventObject">
            <xs:complexType>
              <xs:sequence>
                <xs:element name="uuid" type="xs:string"/>
                <xs:element name="code" type="xs:integer"/>
                <xs:element name="message" type="xs:string" minOccurs="0"/>
              </xs:sequence>
            </xs:complexType>
          </xs:element>
        </xs:schema>
```

2939

2940 **5.3.4.2.2 Template definition example**

2941 This example shows a valid XML datatype value for the 'event\_object' schema declare in the previous  
2942 example.

```
# properties snippet from a TOSCA template definition.
properties:
  event_object: <
    <eventObject>
      <uuid>cdf:1234-56-0000-abcd</uuid>
      <code>9876</code>
    </eventObject>
```

2943 **5.3.5 Additional Requirements**

2944 The xml datatype SHOULD only be assigned string values that contain valid XML syntax as defined by  
2945 the “Extensible Markup Language (XML)” specification” (see reference [XMLSpec]).

2946 **5.3.6 tosca.datatypes.Credential**

2947 The Credential type is a complex TOSCA data Type used when describing authorization credentials used  
2948 to access network accessible resources.

<b>Shorthand Name</b>	Credential
<b>Type Qualified Name</b>	tosca:Credential
<b>Type URI</b>	tosca.datatypes.Credential

2949 **5.3.6.1 Properties**

Name	Required	Type	Constraints	Description
protocol	no	string	None	The optional protocol name.
token_type	yes	string	default: password	The required token type.
token	yes	string	None	The required token used as a credential for authorization or access to a networked resource.
keys	no	map of string	None	The optional list of protocol-specific keys or assertions.
user	no	string	None	The optional user (name or ID) used for non-token based credentials.

2950 **5.3.6.2 Definition**

2951 The TOSCA Credential type is defined as follows:

```
tosca.datatypes.Credential:  
  derived_from: tosca.datatypes.Root  
  properties:  
    protocol:  
      type: string  
      required: false  
    token_type:  
      type: string  
      default: password  
    token:  
      type: string  
    keys:  
      type: map  
      required: false  
  entry_schema:
```

```
    type: string
  user:
    type: string
    required: false
```

### 2952 5.3.6.3 Additional requirements

- 2953
- TOSCA Orchestrators SHALL interpret and validate the value of the **token** property based upon the value of the **token\_type** property.
- 2954

### 2955 5.3.6.4 Notes

- 2956
- Specific token types and encoding them using network protocols are not defined or covered in this specification.
  - The use of transparent user names (IDs) or passwords are not considered best practice.
- 2957
- 2958

### 2959 5.3.6.5 Examples

#### 2960 5.3.6.5.1 Provide a simple user name and password without a protocol or 2961 standardized token format

```
<some_tosca_entity>:
  properties:
    my_credential:
      type: Credential
      properties:
        user: myusername
        token: mypassword
```

#### 2962 5.3.6.5.2 HTTP Basic access authentication credential

```
<some_tosca_entity>:
  properties:
    my_credential: # type: Credential
      protocol: http
      token_type: basic_auth
      # Username and password are combined into a string
      # Note: this would be base64 encoded before transmission by any impl.
      token: myusername:mypassword
```

#### 2963 5.3.6.5.3 X-Auth-Token credential

```
<some_tosca_entity>:
  properties:
    my_credential: # type: Credential
```

```

protocol: xauth
token_type: X-Auth-Token
# token encoded in Base64
token: 604bbe45ac7143a79e14f3158df67091

```

2964 **5.3.6.5.4 OAuth bearer token credential**

```

<some_tosca_entity>:
  properties:
    my_credential: # type: Credential
      protocol: oauth2
      token_type: bearer
      # token encoded in Base64
      token: 8ao9nE2DEjr1zCsicWmpBC

```

2965 **5.3.6.6 OpenStack SSH Keypair**

```

<some_tosca_entity>:
  properties:
    my_ssh_keypair: # type: Credential
      protocol: ssh
      token_type: identifier
      # token is a reference (ID) to an existing keypair (already installed)
      token: <keypair_id>

```

2966

2967 **5.3.7 toasca.datatypes.TimeInterval**

2968 The TimeInterval type is a complex TOSCA data Type used when describing a period of time using the  
 2969 YAML ISO 8601 format to declare the start and end times.

<b>Shorthand Name</b>	TimeInterval
<b>Type Qualified Name</b>	tosca:TimeInterval
<b>Type URI</b>	tosca.datatypes.TimeInterval

2970 **5.3.7.1 Properties**

Name	Required	Type	Constraints	Description
start_time	yes	timestamp	None	The <b>inclusive</b> start time for the time interval.
end_time	yes	timestamp	None	The <b>inclusive</b> end time for the time interval.

2971 **5.3.7.2 Definition**

2972 The TOSCA TimeInterval type is defined as follows:

```

tosca.datatypes.TimeInterval:
  derived_from: tosca.datatypes.Root
  properties:
    start_time:
      type: timestamp
      required: true
    end_time:
      type: timestamp
      required: true

```

### 2973 5.3.7.3 Examples

#### 2974 5.3.7.3.1 Multi-day evaluation time period

```

properties:
  description:
    evaluation_period: Evaluate a service for a 5-day period across time zones
    type: TimeInterval
    start_time: 2016-04-04-15T00:00:00Z
    end_time: 2016-04-08T21:59:43.10-06:00

```

### 2975 5.3.8 tosca.datatypes.network.NetworkInfo

2976 The Network type is a complex TOSCA data type used to describe logical network information.

<b>Shorthand Name</b>	NetworkInfo
<b>Type Qualified Name</b>	tosca:NetworkInfo
<b>Type URI</b>	tosca.datatypes.network.NetworkInfo

#### 2977 5.3.8.1 Properties

Name	Type	Constraints	Description
network_name	string	None	The name of the logical network. e.g., "public", "private", "admin". etc.
network_id	string	None	The unique ID of for the network generated by the network provider.
addresses	string []	None	The list of IP addresses assigned from the underlying network.

#### 2978 5.3.8.2 Definition

2979 The TOSCA NetworkInfo data type is defined as follows:

```

tosca.datatypes.network.NetworkInfo:
  derived_from: tosca.datatypes.Root
  properties:

```

```

network_name:
  type: string
network_id:
  type: string
addresses:
  type: list
entry_schema:
  type: string

```

2980 **5.3.8.3 Examples**

2981 Example usage of the NetworkInfo data type:

```

<some_tosca_entity>:
  properties:
    private_network:
      network_name: private
      network_id: 3e54214f-5c09-1bc9-9999-44100326da1b
      addresses: [ 10.111.128.10 ]

```

2982 **5.3.8.4 Additional Requirements**

- 2983 • It is expected that TOSCA orchestrators MUST be able to map the **network\_name** from the
- 2984 TOSCA model to underlying network model of the provider.
- 2985 • The properties (or attributes) of NetworkInfo may or may not be required depending on usage
- 2986 context.

2987 **5.3.9 tosca.datatypes.network.PortInfo**

2988 The PortInfo type is a complex TOSCA data type used to describe network port information.

<b>Shorthand Name</b>	PortInfo
<b>Type Qualified Name</b>	tosca:PortInfo
<b>Type URI</b>	tosca.datatypes.network.PortInfo

2989 **5.3.9.1 Properties**

Name	Type	Constraints	Description
port_name	<a href="#">string</a>	None	The logical network port name.
port_id	<a href="#">string</a>	None	The unique ID for the network port generated by the network provider.
network_id	<a href="#">string</a>	None	The unique ID for the network.
mac_address	<a href="#">string</a>	None	The unique media access control address ( <b>MAC address</b> ) assigned to the port.
addresses	<a href="#">string</a> []	None	The list of IP address(es) assigned to the port.

2990 **5.3.9.2 Definition**

2991 The TOSCA PortInfo type is defined as follows:

```
tosca.datatypes.network.PortInfo:  
  derived_from: toasca.datatypes.Root  
  properties:  
    port_name:  
      type: string  
    port_id:  
      type: string  
    network_id:  
      type: string  
    mac_address:  
      type: string  
    addresses:  
      type: list  
      entry_schema:  
        type: string
```

2992 **5.3.9.3 Examples**

2993 Example usage of the PortInfo data type:

```
ethernet_port:  
  properties:  
    port_name: port1  
    port_id: 2c0c7a37-691a-23a6-7709-2d10ad041467  
    network_id: 3e54214f-5c09-1bc9-9999-44100326da1b  
    mac_address: f1:18:3b:41:92:1e  
    addresses: [ 172.24.9.102 ]
```

2994 **5.3.9.4 Additional Requirements**

- 2995
- 2996
- 2997
- It is expected that TOSCA orchestrators **MUST** be able to map the **port\_name** from the TOSCA model to underlying network model of the provider.
  - The properties (or attributes) of PortInfo may or may not be required depending on usage context.

2998 **5.3.10 toasca.datatypes.network.PortDef**

2999 The PortDef type is a TOSCA data Type used to define a network port.

<b>Shorthand Name</b>	PortDef
<b>Type Qualified Name</b>	tosca:PortDef
<b>Type URI</b>	tosca.datatypes.network.PortDef

### 3000 5.3.10.1 Definition

3001 The TOSCA PortDef type is defined as follows:

```
tosca.datatypes.network.PortDef:
  derived_from: integer
  constraints:
    - in_range: [ 1, 65535 ]
```

### 3002 5.3.10.2 Examples

3003 Simple usage of a PortDef property type:

```
properties:
  listen_port: 9090
```

3004 Example declaration of a property for a custom type based upon PortDef:

```
properties:
  listen_port:
    type: PortDef
    default: 9000
    constraints:
      - in_range: [ 9000, 9090 ]
```

### 3005 5.3.11 tosca.datatypes.network.PortSpec

3006 The PortSpec type is a complex TOSCA data Type used when describing port specifications for a  
3007 network connection.

<b>Shorthand Name</b>	PortSpec
<b>Type Qualified Name</b>	tosca:PortSpec
<b>Type URI</b>	tosca.datatypes.network.PortSpec

#### 3008 5.3.11.1 Properties

Name	Required	Type	Constraints	Description
protocol	yes	string	default: tcp	The required protocol used on the port.
source	no	PortDef	See PortDef	The optional source port.
source_range	no	range	in_range: [ 1, 65536 ]	The optional range for source port.
target	no	PortDef	See PortDef	The optional target port.
target_range	no	range	in_range: [ 1, 65536 ]	The optional range for target port.



3009 **5.3.11.2 Definition**

3010 The TOSCA PortSpec type is defined as follows:

```
tosca.datatypes.network.PortSpec:
  derived_from: tosca.datatypes.Root
  properties:
    protocol:
      type: string
      required: true
      default: tcp
      constraints:
        - valid_values: [ udp, tcp, igmp ]
    target:
      type: PortDef
      required: false
    target_range:
      type: range
      required: false
      constraints:
        - in_range: [ 1, 65535 ]
    source:
      type: PortDef
      required: false
    source_range:
      type: range
      required: false
      constraints:
        - in_range: [ 1, 65535 ]
```

3011 **5.3.11.3 Additional requirements**

- 3012
- A valid PortSpec MUST have at least one of the following properties: **target**, **target\_range**, **source** or **source\_range**.
- 3013
- A valid PortSpec MUST have a value for the **source** property that is within the numeric range specified by the property **source\_range** when **source\_range** is specified.
- 3014
- A valid PortSpec MUST have a value for the **target** property that is within the numeric range specified by the property **target\_range** when **target\_range** is specified.
- 3015
- 3016
- 3017

3018 **5.3.11.4 Examples**

3019 Example usage of the PortSpec data type:

```
# example properties in a node template
some_endpoint:
```

```
properties:
  ports:
    user_port:
      protocol: tcp
      target: 50000
      target_range: [ 20000, 60000 ]
      source: 9000
      source_range: [ 1000, 10000 ]
```

## 3020 5.4 Artifact Types

3021 TOSCA Artifacts Types represent the types of packages and files used by the orchestrator when  
3022 deploying TOSCA Node or Relationship Types or invoking their interfaces. Currently, artifacts are  
3023 logically divided into three categories:

3024

- 3025 • **Deployment Types:** includes those artifacts that are used during deployment (e.g., referenced  
3026 on create and install operations) and include packaging files such as RPMs, ZIPs, or TAR files.
- 3027 • **Implementation Types:** includes those artifacts that represent imperative logic and are used to  
3028 implement TOSCA Interface operations. These typically include scripting languages such as  
3029 Bash (.sh), Chef [[Chef](#)] and Puppet [[Puppet](#)].
- 3030 • **Runtime Types:** includes those artifacts that are used during runtime by a service or component  
3031 of the application. This could include a library or language runtime that is needed by an  
3032 application such as a PHP or Java library.

3033

3034 **Note:** Additional TOSCA Artifact Types will be developed in future drafts of this specification.

### 3035 5.4.1 `tosca.artifacts.Root`

3036 This is the default (root) TOSCA [Artifact Type](#) definition that all other TOSCA base Artifact Types derive  
3037 from.

#### 3038 5.4.1.1 Definition

```
tosca.artifacts.Root:
  description: The TOSCA Artifact Type all other TOSCA Artifact Types derive from
```

### 3039 5.4.2 `tosca.artifacts.File`

3040 This artifact type is used when an artifact definition needs to have its associated file simply treated as a  
3041 file and no special handling/handlers are invoked (i.e., it is not treated as either an implementation or  
3042 deployment artifact type).

<b>Shorthand Name</b>	File
<b>Type Qualified Name</b>	tosca:File
<b>Type URI</b>	tosca.artifacts.File

3043 **5.4.2.1 Definition**

```
tosca.artifacts.File:
  derived_from: tosca.artifacts.Root
```

3044 **5.4.3 Deployment Types**

3045 **5.4.3.1 tosca.artifacts.Deployment**

3046 This artifact type represents the parent type for all deployment artifacts in TOSCA. This class of artifacts  
 3047 typically represents a binary packaging of an application or service that is used to install/create or deploy  
 3048 it as part of a node's lifecycle.

3049 **5.4.3.1.1 Definition**

```
tosca.artifacts.Deployment:
  derived_from: tosca.artifacts.Root
  description: TOSCA base type for deployment artifacts
```

3050 **5.4.3.2 Additional Requirements**

- 3051 • TOSCA Orchestrators MAY throw an error if it encounters a non-normative deployment artifact  
 3052 type that it is not able to process.

3053 **5.4.3.3 tosca.artifacts.Deployment.Image**

3054 This artifact type represents a parent type for any "image" which is an opaque packaging of a TOSCA  
 3055 Node's deployment (whether real or virtual) whose contents are typically already installed and pre-  
 3056 configured (i.e., "stateful") and prepared to be run on a known target container.

<b>Shorthand Name</b>	Deployment.Image
<b>Type Qualified Name</b>	tosca:Deployment.Image
<b>Type URI</b>	tosca.artifacts.Deployment.Image

3057 **5.4.3.3.1 Definition**

```
tosca.artifacts.Deployment.Image:
  derived_from: tosca.artifacts.Deployment
```

3058 **5.4.3.4 tosca.artifacts.Deployment.Image.VM**

3059 This artifact represents the parent type for all Virtual Machine (VM) image and container formatted  
 3060 deployment artifacts. These images contain a stateful capture of a machine (e.g., server) including

3061 operating system and installed software along with any configurations and can be run on another  
3062 machine using a hypervisor which virtualizes typical server (i.e., hardware) resources.

#### 3063 5.4.3.4.1 Definition

```
tosca.artifacts.Deployment.Image.VM:  
  derived_from: tosca.artifacts.Deployment.Image  
  description: Virtual Machine (VM) Image
```

#### 3064 5.4.3.4.2 Notes

- 3065
- Future drafts of this specification may include popular standard VM disk image (e.g., ISO, VMI, VMDX, QCOW2, etc.) and container (e.g., OVF, bare, etc.) formats. These would include consideration of disk formats such as:
- 3066  
3067

### 3068 5.4.4 Implementation Types

#### 3069 5.4.4.1 [tosca.artifacts.Implementation](#)

3070 This artifact type represents the parent type for all implementation artifacts in TOSCA. These artifacts are  
3071 used to implement operations of TOSCA interfaces either directly (e.g., scripts) or indirectly (e.g., config.  
3072 files).

#### 3073 5.4.4.1.1 Definition

```
tosca.artifacts.Implementation:  
  derived_from: tosca.artifacts.Root  
  description: TOSCA base type for implementation artifacts
```

#### 3074 5.4.4.2 Additional Requirements

- 3075
- TOSCA Orchestrators **MAY** throw an error if it encounters a non-normative implementation  
3076 artifact type that it is not able to process.

#### 3077 5.4.4.3 [tosca.artifacts.Implementation.Bash](#)

3078 This artifact type represents a Bash script type that contains Bash commands that can be executed on  
3079 the Unix Bash shell.

<b>Shorthand Name</b>	Bash
<b>Type Qualified Name</b>	tosca:Bash
<b>Type URI</b>	tosca.artifacts.Implementation.Bash

#### 3080 5.4.4.3.1 Definition

```
tosca.artifacts.Implementation.Bash:  
  derived_from: tosca.artifacts.Implementation  
  description: Script artifact for the Unix Bash shell  
  mime_type: application/x-sh
```

```
file_ext: [ sh ]
```

#### 3081 **5.4.4.4 tosca.artifacts.Implementation.Python**

3082 This artifact type represents a Python file that contains Python language constructs that can be executed  
3083 within a Python interpreter.

<b>Shorthand Name</b>	Python
<b>Type Qualified Name</b>	tosca:Python
<b>Type URI</b>	tosca.artifacts.Implementation.Python

#### 3084 **5.4.4.4.1 Definition**

```
tosca.artifacts.Implementation.Python:  
  derived_from: tosca.artifacts.Implementation  
  description: Artifact for the interpreted Python language  
  mime_type: application/x-python  
  file_ext: [ py ]
```

### 3085 **5.5 Capabilities Types**

#### 3086 **5.5.1 tosca.capabilities.Root**

3087 This is the default (root) TOSCA Capability Type definition that all other TOSCA Capability Types derive  
3088 from.

#### 3089 **5.5.1.1 Definition**

```
tosca.capabilities.Root:  
  description: The TOSCA root Capability Type all other TOSCA Capability Types  
  derive from
```

#### 3090 **5.5.2 tosca.capabilities.Node**

3091 The Node capability indicates the base capabilities of a TOSCA Node Type.

<b>Shorthand Name</b>	Node
<b>Type Qualified Name</b>	tosca:Node
<b>Type URI</b>	tosca.capabilities.Node

#### 3092 **5.5.2.1 Definition**

```
tosca.capabilities.Node:  
  derived_from: tosca.capabilities.Root
```

3093 **5.5.3 tosca.capabilities.Compute**

3094 The Compute capability, when included on a Node Type or Template definition, indicates that the node  
 3095 can provide hosting on a named compute resource.

<b>Shorthand Name</b>	Compute
<b>Type Qualified Name</b>	tosca:Compute
<b>Type URI</b>	tosca.capabilities.Compute

3096 **5.5.3.1 Properties**

Name	Required	Type	Constraints	Description
name	no	string	None	The optional name (or identifier) of a specific compute resource for hosting.
num_cpus	no	integer	greater_or_equal: 1	Number of (actual or virtual) CPUs associated with the Compute node.
cpu_frequency	no	scalar-unit.frequency	greater_or_equal: 0.1 GHz	Specifies the operating frequency of CPU's core. This property expresses the expected frequency of one (1) CPU as provided by the property "num_cpus".
disk_size	no	scalar-unit.size	greater_or_equal: 0 MB	Size of the local disk available to applications running on the Compute node (default unit is MB).
mem_size	no	scalar-unit.size	greater_or_equal: 0 MB	Size of memory available to applications running on the Compute node (default unit is MB).

3097 **5.5.3.2 Definition**

```
tosca.capabilities.Compute:
  derived_from: tosca.capabilities.Container
  shortname: Compute
  properties:
    name:
      type: string
      required: false
    num_cpus:
      type: integer
      required: false
      constraints:
        - greater_or_equal: 1
    cpu_frequency:
      type: scalar-unit.frequency
      required: false
      constraints:
        - greater_or_equal: 0.1 GHz
```

```

disk_size:
  type: scalar-unit.size
  required: false
  constraints:
    - greater_or_equal: 0 MB
mem_size:
  type: scalar-unit.size
  required: false
  constraints:
    - greater_or_equal: 0 MB

```

### 3098 **5.5.4 [tosca.capabilities.Network](#)**

3099 The Storage capability, when included on a Node Type or Template definition, indicates that the node can  
 3100 provide addressibility for the resource a named network with the specified ports.

<b>Shorthand Name</b>	Network
<b>Type Qualified Name</b>	tosca:Network
<b>Type URI</b>	tosca.capabilities.Network

#### 3101 **5.5.4.1 Properties**

Name	Required	Type	Constraints	Description
name	no	string	None	The otional name (or identifier) of a specific network resource.

#### 3102 **5.5.4.2 Definition**

```

tosca.capabilities.Network:
  derived_from: tosca.capabilities.Root
  properties:
    name:
      type: string
      required: false

```

### 3103 **5.5.5 [tosca.capabilities.Storage](#)**

3104 The Storage capability, when included on a Node Type or Template definition, indicates that the node can  
 3105 provide a named storage location with specified size range.

<b>Shorthand Name</b>	Storage
<b>Type Qualified Name</b>	tosca:Storage
<b>Type URI</b>	tosca.capabilities.Storage

3106 **5.5.5.1 Properties**

Name	Required	Type	Constraints	Description
name	no	string	None	The optional name (or identifier) of a specific storage resource.

3107 **5.5.5.2 Definition**

```
tosca.capabilities.Storage:
  derived_from: tosca.capabilities.Root
  properties:
    name:
      type: string
      required: false
```

3108 **5.5.6 tosca.capabilities.Container**

3109 The Container capability, when included on a Node Type or Template definition, indicates that the node  
3110 can act as a container for (or a host for) one or more other declared Node Types.

<b>Shorthand Name</b>	Container
<b>Type Qualified Name</b>	tosca:Container
<b>Type URI</b>	tosca.capabilities.Container

3111 **5.5.6.1 Properties**

Name	Required	Type	Constraints	Description
N/A	N/A	N/A	N/A	N/A

3112 **5.5.6.2 Definition**

```
tosca.capabilities.Container:
  derived_from: tosca.capabilities.Root
```

3113 **5.5.7 tosca.capabilities.Endpoint**

3114 This is the default TOSCA type that should be used or extended to define a network endpoint capability.  
3115 This includes the information to express a basic endpoint with a single port or a complex endpoint with



3116 multiple ports. By default the Endpoint is assumed to represent an address on a private network unless  
 3117 otherwise specified.

<b>Shorthand Name</b>	Endpoint
<b>Type Qualified Name</b>	tosca:Endpoint
<b>Type URI</b>	tosca.capabilities.Endpoint

3118 **5.5.7.1 Properties**

Name	Required	Type	Constraints	Description
protocol	yes	string	default: tcp	The name of the protocol (i.e., the protocol prefix) that the endpoint accepts (any OSI Layer 4-7 protocols)  Examples: http, https, ftp, tcp, udp, etc.
port	no	PortDef	greater_or_equal: 1 less_or_equal: 65535	The optional port of the endpoint.
secure	no	boolean	default: false	Requests for the endpoint to be secure and use credentials supplied on the ConnectsTo relationship.
url_path	no	string	None	The optional URL path of the endpoint's address if applicable for the protocol.
port_name	no	string	None	The optional name (or ID) of the network port this endpoint should be bound to.
network_name	no	string	default: PRIVATE	The optional name (or ID) of the network this endpoint should be bound to. network_name: PRIVATE   PUBLIC   <network_name>   <network_id>
initiator	no	string	one of: • source • target • peer  default: source	The optional indicator of the direction of the connection.
ports	no	map of PortSpec	None	The optional map of ports the Endpoint supports (if more than one)

3119 **5.5.7.2 Attributes**

Name	Required	Type	Constraints	Description
ip_address	yes	string	None	Note: This is the IP address as propagated up by the associated node's host (Compute) container.

3120 **5.5.7.3 Definition**

```
tosca.capabilities.Endpoint:
  derived_from: tosca.capabilities.Root
  properties:
```

```

protocol:
  type: string
  required: true
  default: tcp
port:
  type: PortDef
  required: false
secure:
  type: boolean
  required: false
  default: false
url_path:
  type: string
  required: false
port_name:
  type: string
  required: false
network_name:
  type: string
  required: false
  default: PRIVATE
initiator:
  type: string
  required: false
  default: source
  constraints:
    - valid_values: [ source, target, peer ]
ports:
  type: map
  required: false
  constraints:
    - min_length: 1
  entry_schema:
    type: PortSpec
attributes:
  ip_address:
    type: string

```

#### 3121 5.5.7.4 Additional requirements

- 3122
- 3123
- Although both the port and ports properties are not required, one of port or ports must be provided in a valid [Endpoint](#).

3124 **5.5.8 tosca.capabilities.Endpoint.Public**

3125 This capability represents a public endpoint which is accessible to the general internet (and its public IP  
3126 address ranges).

3127 This public endpoint capability also can be used to create a floating (IP) address that the underlying  
3128 network assigns from a pool allocated from the application's underlying public network. This floating  
3129 address is managed by the underlying network such that can be routed an application's private address  
3130 and remains reliable to internet clients.

<b>Shorthand Name</b>	Endpoint.Public
<b>Type Qualified Name</b>	tosca:Endpoint.Public
<b>Type URI</b>	tosca.capabilities.Endpoint.Public

3131 **5.5.8.1 Definition**

```
tosca.capabilities.Endpoint.Public:
  derived_from: tosca.capabilities.Endpoint
  properties:
    # Change the default network_name to use the first public network found
    network_name:
      type: string
      default: PUBLIC
      constraints:
        - equal: PUBLIC
    floating:
      description: >
        indicates that the public address should be allocated from a pool of
        floating IPs that are associated with the network.
      type: boolean
      default: false
      status: experimental
    dns_name:
      description: The optional name to register with DNS
      type: string
      required: false
      status: experimental
```

3132 **5.5.8.2 Additional requirements**

- 3133 • If the **network\_name** is set to the reserved value **PRIVATE** or if the value is set to the name of  
3134 network (or subnetwork) that is not public (i.e., has non-public IP address ranges assigned to it)  
3135 then TOSCA Orchestrators **SHALL** treat this as an error.
- 3136 • If a **dns\_name** is set, TOSCA Orchestrators SHALL attempt to register the name in the (local)  
3137 DNS registry for the Cloud provider.

3138 **5.5.9 tosca.capabilities.Endpoint.Admin**

3139 This is the default TOSCA type that should be used or extended to define a specialized administrator  
3140 endpoint capability.

<b>Shorthand Name</b>	Endpoint.Admin
<b>Type Qualified Name</b>	tosca:Endpoint.Admin
<b>Type URI</b>	tosca.capabilities.Endpoint.Admin

3141 **5.5.9.1 Properties**

Name	Required	Type	Constraints	Description
None	N/A	N/A	N/A	N/A

3142 **5.5.9.2 Definition**

```
tosca.capabilities.Endpoint.Admin:  
  derived_from: tosca.capabilities.Endpoint  
  # Change Endpoint secure indicator to true from its default of false  
  properties:  
    secure:  
      type: boolean  
      default: true  
      constraints:  
        - equal: true
```

3143 **5.5.9.3 Additional requirements**

- 3144 • TOSCA Orchestrator implementations of Endpoint.Admin (and connections to it) **SHALL** assure  
3145 that network-level security is enforced if possible.

3146 **5.5.10 tosca.capabilities.Endpoint.Database**

3147 This is the default TOSCA type that should be used or extended to define a specialized database  
3148 endpoint capability.

<b>Shorthand Name</b>	Endpoint.Database
<b>Type Qualified Name</b>	tosca:Endpoint.Database
<b>Type URI</b>	tosca.capabilities.Endpoint.Database

3149 **5.5.10.1 Properties**

Name	Required	Type	Constraints	Description
None	N/A	N/A	N/A	N/A

3150 **5.5.10.2 Definition**

```
tosca.capabilities.Endpoint.Database:
  derived_from: tosca.capabilities.Endpoint
```

3151 **5.5.11 tosca.capabilities.Attachment**

3152 This is the default TOSCA type that should be used or extended to define an attachment capability of a  
3153 (logical) infrastructure device node (e.g., [BlockStorage](#) node).

<b>Shorthand Name</b>	Attachment
<b>Type Qualified Name</b>	tosca:Attachment
<b>Type URI</b>	tosca.capabilities.Attachment

3154 **5.5.11.1 Properties**

Name	Required	Type	Constraints	Description
N/A	N/A	N/A	N/A	N/A

3155 **5.5.11.2 Definition**

```
tosca.capabilities.Attachment:
  derived_from: tosca.capabilities.Root
```

3156 **5.5.12 tosca.capabilities.OperatingSystem**

3157 This is the default TOSCA type that should be used to express an Operating System capability for a  
3158 node.

<b>Shorthand Name</b>	OperatingSystem
<b>Type Qualified Name</b>	tosca:OperatingSystem
<b>Type URI</b>	tosca.capabilities.OperatingSystem

3159 **5.5.12.1 Properties**

Name	Required	Type	Constraints	Description
architecture	no	string	None	The Operating System (OS) architecture.  Examples of valid values include: x86_32, x86_64, etc.
type	no	string	None	The Operating System (OS) type.  Examples of valid values include: linux, aix, mac, windows, etc.
distribution	no	string	None	The Operating System (OS) distribution.  Examples of valid values for an "type" of "Linux" would include: debian, fedora, rhel and ubuntu.

Name	Required	Type	Constraints	Description
version	no	<a href="#">version</a>	None	The Operating System version.

3160 **5.5.12.2 Definition**

```

tosca.capabilities.OperatingSystem:
  derived_from: tosca.capabilities.Root
  properties:
    architecture:
      type: string
      required: false
    type:
      type: string
      required: false
    distribution:
      type: string
      required: false
    version:
      type: version
      required: false

```

3161 **5.5.12.3 Additional Requirements**

- 3162 • Please note that the string values for the properties **architecture**, **type** and **distribution**
- 3163 SHALL be normalized to lowercase by processors of the service template for matching purposes.
- 3164 For example, if a “**type**” value is set to either “Linux”, “LINUX” or “linux” in a service template, the
- 3165 processor would normalize all three values to “linux” for matching purposes.

3166 **5.5.13 tosca.capabilities.Scalable**

3167 This is the default TOSCA type that should be used to express a scalability capability for a node.

<b>Shorthand Name</b>	Scalable
<b>Type Qualified Name</b>	tosca:Scalable
<b>Type URI</b>	tosca.capabilities.Scalable

3168 **5.5.13.1 Properties**

Name	Required	Type	Constraints	Description
min_instances	yes	<a href="#">integer</a>	default: 1	This property is used to indicate the minimum number of instances that should be created for the associated TOSCA Node Template by a TOSCA orchestrator.
max_instances	yes	<a href="#">integer</a>	default: 1	This property is used to indicate the maximum number of instances that should be created for the associated TOSCA Node Template by a TOSCA orchestrator.

Name	Required	Type	Constraints	Description
default_instances	no	integer	N/A	<p>An optional property that indicates the requested default number of instances that should be the starting number of instances a TOSCA orchestrator should attempt to allocate.</p> <p><b>Note:</b> The value for this property MUST be in the range between the values set for 'min_instances' and 'max_instances' properties.</p>

3169 **5.5.13.2 Definition**

```

tosca.capabilities.Scalable:
  derived_from: tosca.capabilities.Root
  properties:
    min_instances:
      type: integer
      default: 1
    max_instances:
      type: integer
      default: 1
    default_instances:
      type: integer

```

3170 **5.5.13.3 Notes**

- 3171 • The actual number of instances for a node may be governed by a separate scaling policy which  
3172 conceptually would be associated to either a scaling-capable node or a group of nodes in which it  
3173 is defined to be a part of. This is a planned future feature of the TOSCA Simple Profile and not  
3174 currently described.

3175 **5.5.14 tosca.capabilities.network.Bindable**

3176 A node type that includes the Bindable capability indicates that it can be bound to a logical network  
3177 association via a network port.

<b>Shorthand Name</b>	network.Bindable
<b>Type Qualified Name</b>	tosca:network.Bindable
<b>Type URI</b>	tosca.capabilities.network.Bindable

3178 **5.5.14.1 Properties**

Name	Required	Type	Constraints	Description
N/A	N/A	N/A	N/A	N/A

3179 **5.5.14.2 Definition**

```
tosca.capabilities.network.Bindable:
  derived_from: tosca.capabilities.Node
```

3180 **5.6 Requirement Types**

3181 There are no normative Requirement Types currently defined in this working draft. Typically,  
3182 Requirements are described against a known Capability Type

3183 **5.7 Relationship Types**

3184 **5.7.1 tosca.relationships.Root**

3185 This is the default (root) TOSCA Relationship Type definition that all other TOSCA Relationship Types  
3186 derive from.

3187 **5.7.1.1 Attributes**

Name	Required	Type	Constraints	Description
tosca_id	yes	string	None	A unique identifier of the realized instance of a Relationship Template that derives from any TOSCA normative type.
tosca_name	yes	string	None	This attribute reflects the name of the Relationship Template as defined in the TOSCA service template. This name is not unique to the realized instance model of corresponding deployed application as each template in the model can result in one or more instances (e.g., scaled) when orchestrated to a provider environment.
state	yes	string	default: initial	The state of the relationship instance. See section "Relationship States" for allowed values.

3188 **5.7.1.2 Definition**

```
tosca.relationships.Root:
  description: The TOSCA root Relationship Type all other TOSCA base Relationship
  Types derive from
  attributes:
    tosca_id:
      type: string
    tosca_name:
      type: string
  interfaces:
    Configure:
      type: tosca.interfaces.relationship.Configure
```

3189 **5.7.2 tosca.relationships.DependsOn**

3190 This type represents a general dependency relationship between two nodes.



<b>Shorthand Name</b>	DependsOn
<b>Type Qualified Name</b>	tosca:DependsOn
<b>Type URI</b>	tosca.relationships.DependsOn

3191 **5.7.2.1 Definition**

```
tosca.relationships.DependsOn:
  derived_from: tosca.relationships.Root
  valid_target_types: [ tosca.capabilities.Node ]
```

3192 **5.7.3 tosca.relationships.HostedOn**

3193 This type represents a hosting relationship between two nodes.

<b>Shorthand Name</b>	HostedOn
<b>Type Qualified Name</b>	tosca:HostedOn
<b>Type URI</b>	tosca.relationships.HostedOn

3194 **5.7.3.1 Definition**

```
tosca.relationships.HostedOn:
  derived_from: tosca.relationships.Root
  valid_target_types: [ tosca.capabilities.Container ]
```

3195 **5.7.4 tosca.relationships.ConnectsTo**

3196 This type represents a network connection relationship between two nodes.

<b>Shorthand Name</b>	ConnectsTo
<b>Type Qualified Name</b>	tosca:ConnectsTo
<b>Type URI</b>	tosca.relationships.ConnectsTo

3197 **5.7.4.1 Definition**

```
tosca.relationships.ConnectsTo:
  derived_from: tosca.relationships.Root
  valid_target_types: [ tosca.capabilities.Endpoint ]
  properties:
    credential:
      type: tosca.datatypes.Credential
      required: false
```

3198 **5.7.4.2 Properties**

Name	Required	Type	Constraints	Description
credential	no	<a href="#">Credential</a>	None	The security credential to use to present to the target endpoint to for either authentication or authorization purposes.

3199 **5.7.5 tosca.relationships.AttachesTo**

3200 This type represents an attachment relationship between two nodes. For example, an AttachesTo  
 3201 relationship type would be used for attaching a storage node to a Compute node.

<b>Shorthand Name</b>	AttachesTo
<b>Type Qualified Name</b>	tosca:AttachesTo
<b>Type URI</b>	tosca.relationships.AttachesTo

3202 **5.7.5.1 Properties**

Name	Required	Type	Constraints	Description
location	yes	<a href="#">string</a>	min_length: 1	The relative location (e.g., path on the file system), which provides the root location to address an attached node. e.g., a mount point / path such as '/usr/data'  Note: The user must provide it and it cannot be "root".
device	no	<a href="#">string</a>	None	The logical device name which for the attached device (which is represented by the target node in the model). e.g., '/dev/hda1'

3203 **5.7.5.2 Attributes**

Name	Required	Type	Constraints	Description
device	no	<a href="#">string</a>	None	The logical name of the device as exposed to the instance. Note: A runtime property that gets set when the model gets instantiated by the orchestrator.

3204 **5.7.5.3 Definition**

```
tosca.relationships.AttachesTo:
  derived_from: tosca.relationships.Root
  valid_target_types: [ tosca.capabilities.Attachment ]
  properties:
    location:
      type: string
      constraints:
        - min_length: 1
    device:
      type: string
```

```
required: false
```

## 3205 5.7.6 [tosca.relationships.RoutesTo](#)

3206 This type represents an intentional network routing between two Endpoints in different networks.

<b>Shorthand Name</b>	RoutesTo
<b>Type Qualified Name</b>	tosca:RoutesTo
<b>Type URI</b>	tosca.relationships.RoutesTo

### 3207 5.7.6.1 Definition

```
tosca.relationships.RoutesTo:  
  derived_from: tosca.relationships.ConnectsTo  
  valid_target_types: [ tosca.capabilities.Endpoint ]
```

## 3208 5.8 Interface Types

3209 Interfaces are reusable entities that define a set of operations that that can be included as part of a Node  
3210 type or Relationship Type definition. Each named operations may have code or scripts associated with  
3211 them that orchestrators can execute for when transitioning an application to a given state.

### 3212 5.8.1 Additional Requirements

- 3213 • Designers of Node or Relationship types are not required to actually provide/associate code or  
3214 scripts with every operation for a given interface it supports. In these cases, orchestrators SHALL  
3215 consider that a “No Operation” or “no-op”.
- 3216 • The default behavior when providing scripts for an operation in a sub-type (sub-class) or a  
3217 template of an existing type which already has a script provided for that operation SHALL be  
3218 override. Meaning that the subclasses’ script is used in place of the parent type’s script.

### 3219 5.8.2 Best Practices

- 3220 • When TOSCA Orchestrators substitute an implementation for an abstract node in a deployed  
3221 service template it SHOULD be able to present a confirmation to the submitter to confirm the  
3222 implementation chosen would be acceptable.

### 3223 5.8.3 [tosca.interfaces.Root](#)

3224 This is the default (root) TOSCA Interface Type definition that all other TOSCA Interface Types derive  
3225 from.

#### 3226 5.8.3.1 Definition

```
tosca.interfaces.Root:  
  derived_from: tosca.entity.Root  
  description: The TOSCA root Interface Type all other TOSCA Interface Types  
  derive from
```

3227 **5.8.4 tosca.interfaces.node.lifecycle.Standard**

3228 This lifecycle interface defines the essential, normative operations that TOSCA nodes may support.

<b>Shorthand Name</b>	Standard
<b>Type Qualified Name</b>	tosca: Standard
<b>Type URI</b>	tosca.interfaces.node.lifecycle.Standard

3229 **5.8.4.1 Definition**

```

tosca.interfaces.node.lifecycle.Standard:
  derived_from: tosca.interfaces.Root
  create:
    description: Standard lifecycle create operation.
  configure:
    description: Standard lifecycle configure operation.
  start:
    description: Standard lifecycle start operation.
  stop:
    description: Standard lifecycle stop operation.
  delete:
    description: Standard lifecycle delete operation.

```

3230 **5.8.4.2 Create operation**

3231 The create operation is generally used to create the resource or service the node represents in the  
3232 topology. TOSCA orchestrators expect node templates to provide either a deployment artifact or an  
3233 implementation artifact of a defined artifact type that it is able to process. This specification defines  
3234 normative deployment and implementation artifact types all TOSCA Orchestrators are expected to be  
3235 able to process to support application portability.

3236 **5.8.4.3 TOSCA Orchestrator processing of Deployment artifacts**

3237 TOSCA Orchestrators, when encountering a deployment artifact on the create operation; will  
3238 automatically attempt to deploy the artifact based upon its artifact type. This means that no  
3239 implementation artifacts (e.g., scripts) are needed on the create operation to provide commands that  
3240 deploy or install the software.

3241  
3242 For example, if a TOSCA Orchestrator is processing an application with a node of type  
3243 SoftwareComponent and finds that the node's template has a create operation that provides a filename  
3244 (or references to an artifact which describes a file) of a known TOSCA deployment artifact type such as  
3245 an Open Virtualization Format (OVF) image it will automatically deploy that image into the  
3246 SoftwareComponent's host Compute node.

3247 **5.8.4.4 Operation sequencing and node state**

3248 The following diagrams show how TOSCA orchestrators sequence the operations of the Standard  
3249 lifecycle in normal node startup and shutdown procedures.

3250 The following key should be used to interpret the diagrams:

Operation Invocation	
Node State	
Transition State	

3251 **5.8.4.4.1 Normal node startup sequence diagram**

3252 The following diagram shows how the TOSCA orchestrator would invoke operations on the Standard  
 3253 lifecycle to startup a node.

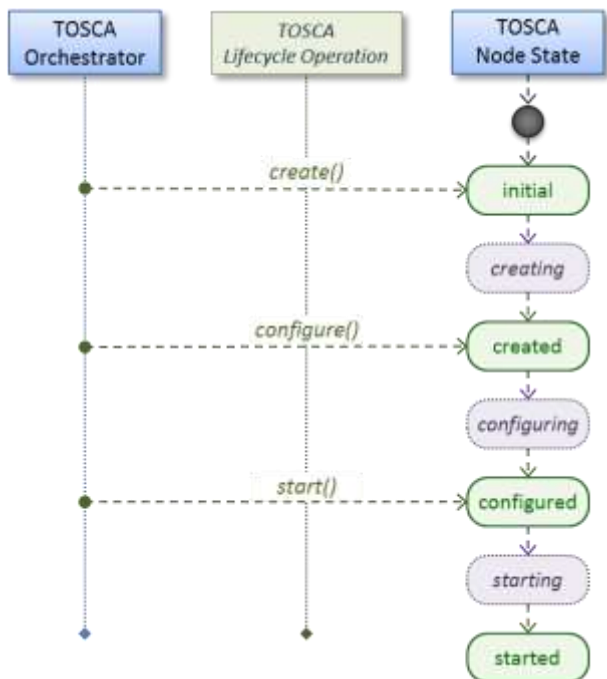

3254 **5.8.4.4.2 Normal node shutdown sequence diagram**

3255 The following diagram shows how the TOSCA orchestrator would invoke operations on the Standard  
 3256 lifecycle to shut down a node.

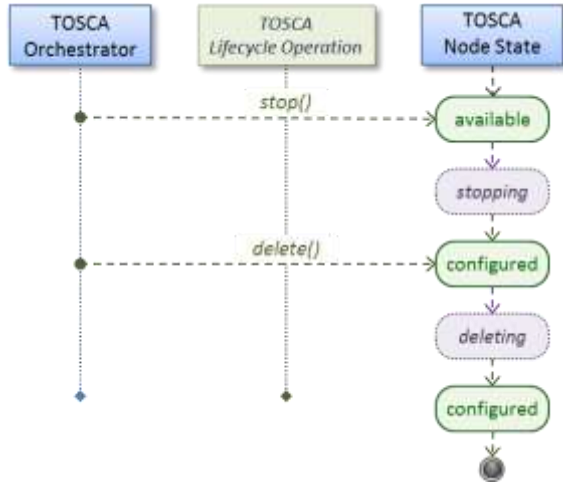

3257

3258 **5.8.5 [tosca.interfaces.relationship.Configure](#)**

3259 The lifecycle interfaces define the essential, normative operations that each TOSCA Relationship Types  
 3260 may support.

<b>Shorthand Name</b>	Configure
<b>Type Qualified Name</b>	tosca:Configure
<b>Type URI</b>	tosca.interfaces.relationship.Configure

3261 **5.8.5.1 Definition**

```

tosca.interfaces.relationship.Configure:
  derived_from: tosca.interfaces.Root
  pre_configure_source:
    description: Operation to pre-configure the source endpoint.
  pre_configure_target:
    description: Operation to pre-configure the target endpoint.
  post_configure_source:
    description: Operation to post-configure the source endpoint.
  post_configure_target:
    description: Operation to post-configure the target endpoint.
  add_target:
    description: Operation to notify the source node of a target node being added
    via a relationship.
  add_source:
    description: Operation to notify the target node of a source node which is
    now available via a relationship.
    description:
  target_changed:
    description: Operation to notify source some property or attribute of the
    target changed
  
```

remove\_target:  
description: Operation to remove a target node.

3262

### 3263 5.8.5.2 Invocation Conventions

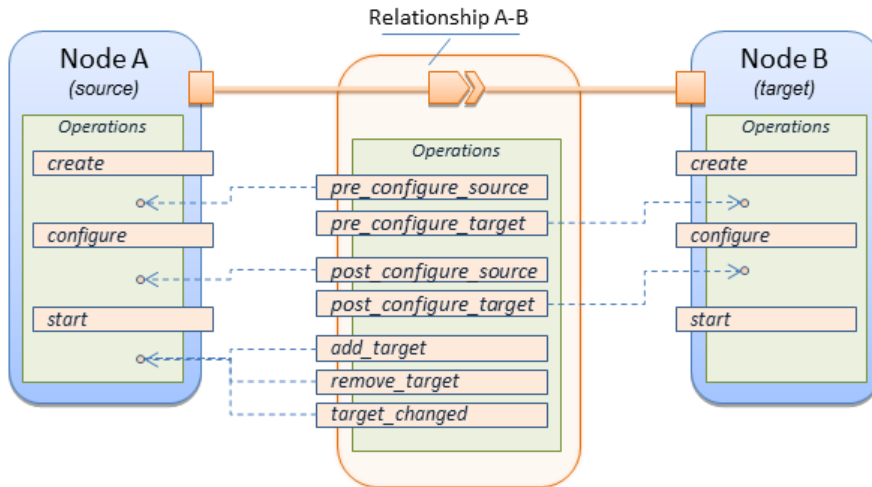

3264 TOSCA relationships are directional connecting a source node to a target node. When TOSCA  
3265 Orchestrator connects a source and target node together using a relationship that supports the Configure  
3266 interface it will “interleave” the operations invocations of the Configure interface with those of the node’s  
3267 own Standard lifecycle interface. This concept is illustrated below:

3268 **5.8.5.3 Normal node start sequence with Configure relationship operations**

3269 The following diagram shows how the TOSCA orchestrator would invoke Configure lifecycle operations in  
 3270 conjunction with Standard lifecycle operations during a typical startup sequence on a node.

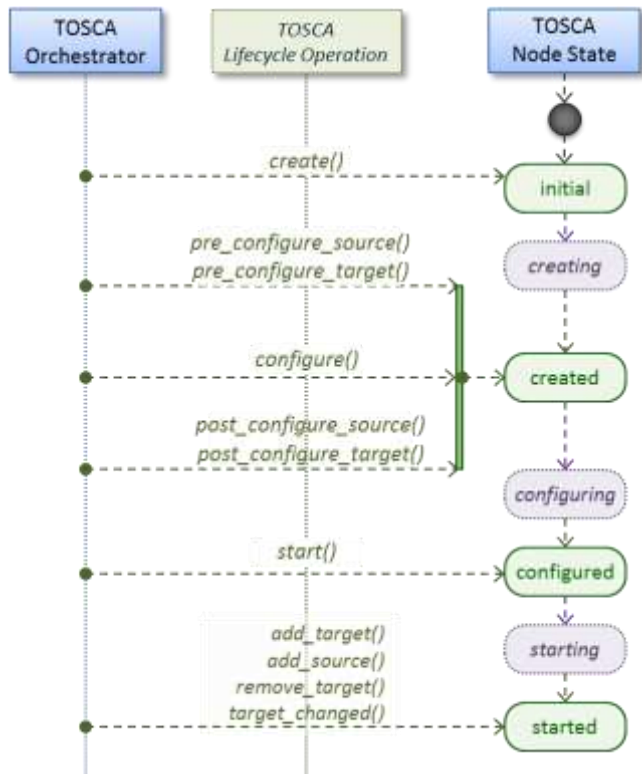

3271 **5.8.5.4 Node-Relationship configuration sequence**

3272 Depending on which side (i.e., source or target) of a relationship a node is on, the orchestrator will:

- 3273 • Invoke either the **pre\_configure\_source** or **pre\_configure\_target** operation as supplied by
- 3274 the relationship on the node.
- 3275 • Invoke the node's **configure** operation.
- 3276 • Invoke either the **post\_configure\_source** or **post\_configure\_target** as supplied by the
- 3277 relationship on the node.

3278 Note that the **pre\_configure\_xxx** and **post\_configure\_xxx** are invoked only once per node instance.

3279 **5.8.5.4.1 Node-Relationship add, remove and changed sequence**

3280 Since a topology template contains nodes that can dynamically be added (and scaled), removed or  
 3281 changed as part of an application instance, the Configure lifecycle includes operations that are invoked  
 3282 on node instances that to notify and address these dynamic changes.

3283 For example, a source node, of a relationship that uses the Configure lifecycle, will have the relationship  
 3284 operations **add\_target**, or **remove\_target** invoked on it whenever a target node instance is added or  
 3285 removed to the running application instance. In addition, whenever the node state of its target node  
 3286 changes, the **target\_changed** operation is invoked on it to address this change. Conversely, the  
 3287 **add\_source** and **remove\_source** operations are invoked on the source node of the relationship.



3289 **5.8.5.5 Notes**

- 3290 • The target (provider) **MUST** be active and running (i.e., all its dependency stack **MUST** be
- 3291 fulfilled) prior to invoking `add_target`
- 3292 • In other words, all Requirements **MUST** be satisfied before it advertises its capabilities (i.e.,
- 3293 the attributes of the matched Capabilities are available).
- 3294 • In other words, it cannot be “consumed” by any dependent node.
- 3295 • Conversely, since the source (consumer) needs information (attributes) about any targets
- 3296 (and their attributes) being removed before it actually goes away.
- 3297 • The `remove_target` operation should only be executed if the target has had `add_target`
- 3298 executed. **BUT** in truth we’re first informed about a target in `pre_configure_source`, so if we
- 3299 execute that the source node should see `remove_target` called to cleanup.
- 3300 • **Error handling:** If any node operation of the topology fails processing should stop on that node
- 3301 template and the failing operation (script) should return an error (failure) code when possible.

3302 **5.9 Node Types**

3303 **5.9.1 tosca.nodes.Root**

3304 The TOSCA **Root** Node Type is the default type that all other TOSCA base Node Types derive from.

3305 This allows for all TOSCA nodes to have a consistent set of features for modeling and management (e.g.,

3306 consistent definitions for requirements, capabilities and lifecycle interfaces).

3307

<b>Shorthand Name</b>	Root
<b>Type Qualified Name</b>	tosca:Root
<b>Type URI</b>	tosca.nodes.Root

3308 **5.9.1.1 Properties**

Name	Required	Type	Constraints	Description
N/A	N/A	N/A	N/A	The TOSCA Root Node type has no specified properties.

3309 **5.9.1.2 Attributes**

Name	Required	Type	Constraints	Description
tosca_id	yes	string	None	A unique identifier of the realized instance of a Node Template that derives from any TOSCA normative type.
tosca_name	yes	string	None	This attribute reflects the name of the Node Template as defined in the TOSCA service template. This name is not unique to the realized instance model of corresponding deployed application as each template in the model can result in one or more instances (e.g., scaled) when orchestrated to a provider environment.
state	yes	string	default: initial	The state of the node instance. See section “ <a href="#">Node States</a> ” for allowed values.

3310 **5.9.1.3 Definition**

```

tosca.nodes.Root:
  derived_from: tosca.entity.Root
  description: The TOSCA Node Type all other TOSCA base Node Types derive from
  attributes:
    tosca_id:
      type: string
    tosca_name:
      type: string
    state:
      type: string
  capabilities:
    feature:
      type: tosca.capabilities.Node
  requirements:
    - dependency:
        capability: tosca.capabilities.Node
        node: tosca.nodes.Root
        relationship: tosca.relationships.DependsOn
        occurrences: [ 0, UNBOUNDED ]
  interfaces:
    Standard:
      type: tosca.interfaces.node.lifecycle.Standard

```

3311 **5.9.1.4 Additional Requirements**

- 3312 • All Node Type definitions that wish to adhere to the TOSCA Simple Profile **SHOULD** extend from the  
 3313 TOSCA Root Node Type to be assured of compatibility and portability across implementations.

3314 **5.9.2 tosca.nodes.Abstract.Compute**

3315 The TOSCA **Abstract.Compute** node represents an abstract compute resource without any requirements  
 3316 on storage or network resources.

3317

<b>Shorthand Name</b>	Abstract.Compute
<b>Type Qualified Name</b>	tosca:Abstract.Compute
<b>Type URI</b>	tosca.nodes.Abstract.Compute

3318 **5.9.2.1 Properties**

Name	Required	Type	Constraints	Description
N/A	N/A	N/A	N/A	N/A

3319 **5.9.2.2 Attributes**

Name	Required	Type	Constraints	Description
N/A	N/A	N/A	N/A	N/A

3320 **5.9.2.3 Definition**

```
tosca.nodes.Abstract.Compute:
  derived_from: tosca.nodes.Root
  capabilities:
    host:
      type: tosca.capabilities.Compute
  valid_source_types: []
```

3321 **5.9.3 tosca.nodes.Compute**

3322 The TOSCA **Compute** node represents one or more real or virtual processors of software applications or  
 3323 services along with other essential local resources. Collectively, the resources the compute node  
 3324 represents can logically be viewed as a (real or virtual) “server”.

<b>Shorthand Name</b>	Compute
<b>Type Qualified Name</b>	tosca:Compute
<b>Type URI</b>	tosca.nodes.Compute

3325 **5.9.3.1 Properties**

Name	Required	Type	Constraints	Description
N/A	N/A	N/A	N/A	N/A

3326 **5.9.3.2 Attributes**

Name	Required	Type	Constraints	Description
private_address	no	<a href="#">string</a>	None	The primary private IP address assigned by the cloud provider that applications may use to access the Compute node.
public_address	no	<a href="#">string</a>	None	The primary public IP address assigned by the cloud provider that applications may use to access the Compute node.
networks	no	<a href="#">map of NetworkInfo</a>	None	The list of logical networks assigned to the compute host instance and information about them.
ports	no	<a href="#">map of PortInfo</a>	None	The list of logical ports assigned to the compute host instance and information about them.

3327 **5.9.3.3 Definition**

```
tosca.nodes.Compute:
```

```

derived_from: tosca.nodes.Abstract.Compute
attributes:
  private_address:
    type: string
  public_address:
    type: string
  networks:
    type: map
    entry_schema:
      type: tosca.datatypes.network.NetworkInfo
  ports:
    type: map
    entry_schema:
      type: tosca.datatypes.network.PortInfo
requirements:
  - local_storage:
      capability: tosca.capabilities.Attachment
      node: tosca.nodes.BlockStorage
      relationship: tosca.relationships.AttachesTo
      occurrences: [0, UNBOUNDED]
capabilities:
  host:
    type: tosca.capabilities.Compute
    valid_source_types: [tosca.nodes.SoftwareComponent]
  endpoint:
    type: tosca.capabilities.Endpoint.Admin
  os:
    type: tosca.capabilities.OperatingSystem
  scalable:
    type: tosca.capabilities.Scalable
  binding:
    type: tosca.capabilities.network.Bindable

```

### 3328 5.9.3.4 Additional Requirements

- 3329
- 3330
- 3331
- The underlying implementation of the Compute node SHOULD have the ability to instantiate guest operating systems (either actual or virtualized) based upon the OperatingSystem capability properties if they are supplied in the a node template derived from the Compute node type.

### 3332 5.9.4 [tosca.nodes.SoftwareComponent](#)

3333 The TOSCA **SoftwareComponent** node represents a generic software component that can be managed  
 3334 and run by a TOSCA **Compute** Node Type.

<b>Shorthand Name</b>	SoftwareComponent
<b>Type Qualified Name</b>	tosca:SoftwareComponent
<b>Type URI</b>	tosca.nodes.SoftwareComponent

3335 **5.9.4.1 Properties**

Name	Required	Type	Constraints	Description
component_version	no	<a href="#">version</a>	None	The optional software component's version.
admin_credential	no	Credential	None	The optional credential that can be used to authenticate to the software component.

3336 **5.9.4.2 Attributes**

Name	Required	Type	Constraints	Description
N/A	N/A	N/A	N/A	N/A

3337 **5.9.4.3 Definition**

```

tosca.nodes.SoftwareComponent:
  derived_from: tosca.nodes.Root
  properties:
    # domain-specific software component version
    component_version:
      type: version
      required: false
    admin_credential:
      type: tosca.datatypes.Credential
      required: false
  requirements:
    - host:
      capability: tosca.capabilities.Compute
      node: tosca.nodes.Compute
      relationship: tosca.relationships.HostedOn

```

3338 **5.9.4.4 Additional Requirements**

- 3339     • Nodes that can directly be managed and run by a TOSCA **Compute** Node Type **SHOULD** extend  
3340     from this type.

3341 **5.9.5 tosca.nodes.WebServer**

3342 This TOSA **WebServer** Node Type represents an abstract software component or service that is capable  
3343 of hosting and providing management operations for one or more **WebApplication** nodes.

<b>Shorthand Name</b>	WebServer
<b>Type Qualified Name</b>	tosca:WebServer
<b>Type URI</b>	tosca.nodes.WebServer

3344 **5.9.5.1 Properties**

Name	Required	Type	Constraints	Description
None	N/A	N/A	N/A	N/A

3345 **5.9.5.2 Definition**

```
tosca.nodes.WebServer:
  derived_from: tosca.nodes.SoftwareComponent
  capabilities:
    # Private, layer 4 endpoints
    data_endpoint: tosca.capabilities.Endpoint
    admin_endpoint: tosca.capabilities.Endpoint.Admin
  host:
    type: tosca.capabilities.Compute
    valid_source_types: [ tosca.nodes.WebApplication ]
```

3346 **5.9.5.3 Additional Requirements**

- 3347 • This node **SHALL** export both a secure endpoint capability (i.e., **admin\_endpoint**), typically for  
3348 administration, as well as a regular endpoint (i.e., **data\_endpoint**) for serving data.

3349 **5.9.6 tosca.nodes.WebApplication**

3350 The TOSCA **WebApplication** node represents a software application that can be managed and run by a  
3351 TOSCA **WebServer** node. Specific types of web applications such as Java, etc. could be derived from  
3352 this type.

<b>Shorthand Name</b>	WebApplication
<b>Type Qualified Name</b>	tosca: WebApplication
<b>Type URI</b>	tosca.nodes.WebApplication

3353 **5.9.6.1 Properties**

Name	Required	Type	Constraints	Description
context_root	no	<a href="#">string</a>	None	The web application's context root which designates the application's URL path within the web server it is hosted on.

3354 **5.9.6.2 Definition**

```

tosca.nodes.WebApplication:
  derived_from: tosca.nodes.Root
  properties:
    context_root:
      type: string
  capabilities:
    app_endpoint:
      type: tosca.capabilities.Endpoint
  requirements:
    - host:
      capability: tosca.capabilities.Compute
      node: tosca.nodes.WebServer
      relationship: tosca.relationships.HostedOn

```

3355 **5.9.7 tosca.nodes.DBMS**

3356 The TOSCA **DBMS** node represents a typical relational, SQL Database Management System software  
 3357 component or service.

3358 **5.9.7.1 Properties**

Name	Required	Type	Constraints	Description
root_password	no	<a href="#">string</a>	None	The optional root password for the DBMS server.
port	no	<a href="#">integer</a>	None	The DBMS server's port.

3359 **5.9.7.2 Definition**

```

tosca.nodes.DBMS:
  derived_from: tosca.nodes.SoftwareComponent
  properties:
    root_password:
      type: string
      required: false
      description: the optional root password for the DBMS service
    port:
      type: integer
      required: false
      description: the port the DBMS service will listen to for data and requests
  capabilities:
    host:
      type: tosca.capabilities.Compute
  valid_source_types: [ tosca.nodes.Database ]

```

3360 **5.9.8 tosca.nodes.Database**

3361 The TOSCA Database node represents a logical database that can be managed and hosted by a TOSCA  
3362 DBMS node.

<b>Shorthand Name</b>	Database
<b>Type Qualified Name</b>	tosca:Database
<b>Type URI</b>	tosca.nodes.Database

3363 **5.9.8.1 Properties**

Name	Required	Type	Constraints	Description
name	yes	string	None	The logical database Name
port	no	integer	None	The port the database service will use to listen for incoming data and requests.
user	no	string	None	The special user account used for database administration.
password	no	string	None	The password associated with the user account provided in the 'user' property.

3364 **5.9.8.2 Definition**

```
tosca.nodes.Database:  
  derived_from: tosca.nodes.Root  
  properties:  
    name:  
      type: string  
      description: the logical name of the database  
    port:  
      type: integer  
      description: the port the underlying database service will listen to for  
data  
    user:  
      type: string  
      description: the optional user account name for DB administration  
      required: false  
    password:  
      type: string  
      description: the optional password for the DB user account  
      required: false  
  requirements:  
    - host:  
      capability: tosca.capabilities.Compute  
      node: tosca.nodes.DBMS
```



```

relationship: tosca.relationships.HostedOn
capabilities:
  database_endpoint:
    type: tosca.capabilities.Endpoint.Database

```

### 3365 **5.9.9 tosca.nodes.Abstract.Storage**

3366 The TOSCA **Abstract.Storage** node represents an abstract storage resource without any requirements  
 3367 on compute or network resources.

<b>Shorthand Name</b>	AbstractStorage
<b>Type Qualified Name</b>	tosca:Abstract.Storage
<b>Type URI</b>	tosca.nodes.Abstract.Storage

#### 3368 **5.9.9.1 Properties**

Name	Required	Type	Constraints	Description
name	yes	<a href="#">string</a>	None	The logical name (or ID) of the storage resource.
size	no	<a href="#">scalar-unit.size</a>	<a href="#">greater_or_equal</a> 1: 0 MB	The requested initial storage size (default unit is in Gigabytes).

#### 3369 **5.9.9.2 Definition**

```

tosca.nodes.Abstract.Storage:
  derived_from: tosca.nodes.Root
  properties:
    name:
      type: string
    size:
      type: scalar-unit.size
      default: 0 MB
      constraints:
        - greater\_or\_equal: 0 MB
  capabilities:
    # TBD

```

### 3370 **5.9.10 tosca.nodes.Storage.ObjectStorage**

3371 The TOSCA **ObjectStorage** node represents storage that provides the ability to store data as objects (or  
 3372 BLOBs of data) without consideration for the underlying filesystem or devices.

<b>Shorthand Name</b>	ObjectStorage
<b>Type Qualified Name</b>	tosca:ObjectStorage
<b>Type URI</b>	tosca.nodes.Storage.ObjectStorage

3373 **5.9.10.1 Properties**

Name	Required	Type	Constraints	Description
maxsize	no	scalar-unit.size	greater_or_equal: 1 GB	The requested maximum storage size (default unit is in Gigabytes).

3374 **5.9.10.2 Definition**

```
tosca.nodes.Storage.ObjectStorage:
  derived_from: tosca.nodes.Abstract.Storage
  properties:
    maxsize:
      type: scalar-unit.size
      constraints:
        - greater_or_equal: 0 GB
  capabilities:
    storage_endpoint:
      type: tosca.capabilities.Endpoint
```

3375 **5.9.10.3 Notes:**

- 3376 • Subclasses of the `tosca.nodes.ObjectStorage` node type may impose further constraints on  
3377 properties. For example, a subclass may constrain the (minimum or maximum) length of the  
3378 'name' property or include a regular expression to constrain allowed characters used in the  
3379 'name' property.

3380 **5.9.11 tosca.nodes.Storage.BlockStorage**

3381 The TOSCA **BlockStorage** node currently represents a server-local block storage device (i.e., not  
3382 shared) offering evenly sized blocks of data from which raw storage volumes can be created.

3383 **Note:** In this draft of the TOSCA Simple Profile, distributed or Network Attached Storage (NAS) are not  
3384 yet considered (nor are clustered file systems), but the TC plans to do so in future drafts.

<b>Shorthand Name</b>	BlockStorage
<b>Type Qualified Name</b>	tosca:BlockStorage
<b>Type URI</b>	tosca.nodes.Storage.BlockStorage

3385

3386 **5.9.11.1 Properties**

Name	Required	Type	Constraints	Description
size	yes *	scalar-unit.size	greater_or_equal: 1 MB	The requested storage size (default unit is MB). * <b>Note:</b> <ul style="list-style-type: none"> <li>• <b>Required</b> when an existing volume (i.e., <b>volume_id</b>) is not available.</li> <li>• If <b>volume_id</b> is provided, size is ignored. Resize of existing volumes is not considered at this time.</li> </ul>
volume_id	no	string	None	ID of an existing volume (that is in the accessible scope of the requesting application).
snapshot_id	no	string	None	Some identifier that represents an existing snapshot that should be used when creating the block storage (volume).

3387 **5.9.11.2 Attributes**

Name	Required	Type	Constraints	Description
N/A	N/A	N/A	N/A	N/A

3388 **5.9.11.3 Definition**

```

tosca.nodes.Storage.BlockStorage:
  derived_from: tosca.nodes.Abstract.Storage
  properties:
    volume_id:
      type: string
      required: false
    snapshot_id:
      type: string
      required: false
  capabilities:
    attachment:
      type: tosca.capabilities.Attachment

```

3389 **5.9.11.4 Additional Requirements**

- 3390     • The **size** property is required when an existing volume (i.e., **volume\_id**) is not available.  
 3391     However, if the property **volume\_id** is provided, the **size** property is ignored.

3392 **5.9.11.5 Notes**

- 3393     • Resize is of existing volumes is not considered at this time.

- 3394 • It is assumed that the volume contains a single filesystem that the operating system (that is  
3395 hosting an associate application) can recognize and mount without additional information (i.e., it  
3396 is operating system independent).
- 3397 • Currently, this version of the Simple Profile does not consider regions (or availability zones) when  
3398 modeling storage.

### 3399 5.9.12 [tosca.nodes.Container.Runtime](#)

3400 The TOSCA **Container** Runtime node represents operating system-level virtualization technology used  
3401 to run multiple application services on a single Compute host.

<b>Shorthand Name</b>	Container.Runtime
<b>Type Qualified Name</b>	tosca:Container.Runtime
<b>Type URI</b>	tosca.nodes.Container.Runtime

#### 3402 5.9.12.1 Definition

```
tosca.nodes.Container.Runtime:
  derived_from: tosca.nodes.SoftwareComponent
  capabilities:
    host:
      type: tosca.capabilities.Compute
      valid_source_types: [tosca.nodes.Container.Application]
  scalable:
    type: tosca.capabilities.Scalable
```

### 3403 5.9.13 [tosca.nodes.Container.Application](#)

3404 The TOSCA **Container** Application node represents an application that requires **Container**-level  
3405 virtualization technology.

<b>Shorthand Name</b>	Container.Application
<b>Type Qualified Name</b>	tosca:Container.Application
<b>Type URI</b>	tosca.nodes.Container.Application

#### 3406 5.9.13.1 Definition

```
tosca.nodes.Container.Application:
  derived_from: tosca.nodes.Root
  requirements:
    - host:
      capability: tosca.capabilities.Compute
      node: tosca.nodes.Container.Runtime
      relationship: tosca.relationships.HostedOn
    - storage:
```

```
    capability: tosca.capabilities.Storage
- network:
    capability: tosca.capabilities.EndPoint
```

## 3407 5.9.14 [tosca.nodes.LoadBalancer](#)

3408 The TOSCA **Load Balancer** node represents logical function that be used in conjunction with a Floating  
3409 Address to distribute an application's traffic (load) across a number of instances of the application (e.g.,  
3410 for a clustered or scaled application).

<b>Shorthand Name</b>	LoadBalancer
<b>Type Qualified Name</b>	tosca:LoadBalancer
<b>Type URI</b>	tosca.nodes.LoadBalancer

### 3411 5.9.14.1 Definition

```
tosca.nodes.LoadBalancer:
  derived_from: tosca.nodes.Root
  properties:
    algorithm:
      type: string
      required: false
      status: experimental
  capabilities:
    client:
      type: tosca.capabilities.Endpoint.Public
      occurrences: [0, UNBOUNDED]
      description: the Floating (IP) client's on the public network can connect
to
  requirements:
    - application:
      capability: tosca.capabilities.Endpoint
      relationship: tosca.relationships.RoutesTo
      occurrences: [0, UNBOUNDED]
      description: Connection to one or more load balanced applications
```

### 3412 5.9.14.2 Notes:

- 3413 • A **LoadBalancer** node can still be instantiated and managed independently of any applications it  
3414 would serve; therefore, the load balancer's **application** requirement allows for zero  
3415 occurrences.

## 3416 5.10 Group Types

3417 TOSCA Group Types represent logical groupings of TOSCA nodes that have an implied membership  
3418 relationship and may need to be orchestrated or managed together to achieve some result. Some use

3419 cases being developed by the TOSCA TC use groups to apply TOSCA policies for software placement  
3420 and scaling while other use cases show groups can be used to describe cluster relationships.

3421  
3422 **Note:** Additional normative TOSCA Group Types and use cases for them will be developed in future  
3423 drafts of this specification.

## 3424 **5.10.1 `tosca.groups.Root`**

3425 This is the default (root) TOSCA `Group Type` definition that all other TOSCA base Group Types derive  
3426 from.

### 3427 **5.10.1.1 Definition**

```
tosca.groups.Root:  
  description: The TOSCA Group Type all other TOSCA Group Types derive from  
  interfaces:  
    Standard:  
      type: tosca.interfaces.node.lifecycle.Standard
```

### 3428 **5.10.1.2 Notes:**

- 3429 • Group operations are not necessarily tied directly to member nodes that are part of a group.
- 3430 • Future versions of this specification will create sub types of the `tosca.groups.Root` type that will  
3431 describe how Group Type operations are to be orchestrated.

## 3432 **5.11 Policy Types**

3433 TOSCA Policy Types represent logical grouping of TOSCA nodes that have an implied relationship and  
3434 need to be orchestrated or managed together to achieve some result. Some use cases being developed  
3435 by the TOSCA TC use groups to apply TOSCA policies for software placement and scaling while other  
3436 use cases show groups can be used to describe cluster relationships.

### 3437 **5.11.1 `tosca.policies.Root`**

3438 This is the default (root) TOSCA Policy Type definition that all other TOSCA base Policy Types derive  
3439 from.

#### 3440 **5.11.1.1 Definition**

```
tosca.policies.Root:  
  description: The TOSCA Policy Type all other TOSCA Policy Types derive from
```

### 3441 **5.11.2 `tosca.policies.Placement`**

3442 This is the default (root) TOSCA Policy Type definition that is used to govern placement of TOSCA nodes  
3443 or groups of nodes.

#### 3444 **5.11.2.1 Definition**

```
tosca.policies.Placement:  
  derived_from: tosca.policies.Root
```

description: The TOSCA Policy Type definition that is used to govern placement of TOSCA nodes or groups of nodes.

### 3445 **5.11.3 tosca.policies.Scaling**

3446 This is the default (root) TOSCA Policy Type definition that is used to govern scaling of TOSCA nodes or  
3447 groups of nodes.

#### 3448 **5.11.3.1 Definition**

tosca.policies.Scaling:

derived\_from: [tosca.policies.Root](#)

description: The TOSCA Policy Type definition that is used to govern scaling of TOSCA nodes or groups of nodes.

### 3449 **5.11.4 tosca.policies.Update**

3450 This is the default (root) TOSCA Policy Type definition that is used to govern update of TOSCA nodes or  
3451 groups of nodes.

#### 3452 **5.11.4.1 Definition**

tosca.policies.Update:

derived\_from: [tosca.policies.Root](#)

description: The TOSCA Policy Type definition that is used to govern update of TOSCA nodes or groups of nodes.

### 3453 **5.11.5 tosca.policies.Performance**

3454 This is the default (root) TOSCA Policy Type definition that is used to declare performance requirements  
3455 for TOSCA nodes or groups of nodes.

#### 3456 **5.11.5.1 Definition**

tosca.policies.Performance:

derived\_from: [tosca.policies.Root](#)

description: The TOSCA Policy Type definition that is used to declare performance requirements for TOSCA nodes or groups of nodes.

3457

---

## 6 TOSCA Cloud Service Archive (CSAR) format

3458

3459 Except for the examples, this section is **normative** and defines changes to the TOSCA archive format  
3460 relative to the TOSCA v1.0 XML specification.

3461

3462 TOSCA Simple Profile definitions along with all accompanying artifacts (e.g. scripts, binaries,  
3463 configuration files) can be packaged together in a CSAR file as already defined in the TOSCA version 1.0  
3464 specification [**TOSCA-1.0**]. In contrast to the TOSCA 1.0 CSAR file specification (see chapter 16 in  
3465 [**TOSCA-1.0**]), this simple profile makes a few simplifications both in terms of overall CSAR file structure  
3466 as well as meta-file content as described below.

### 6.1 Overall Structure of a CSAR

3467

3468 A CSAR zip file is required to contain one of the following:

- 3469 • a **TOSCA-Metadata** directory, which in turn contains the **TOSCA.meta** metadata file that provides  
3470 entry information for a TOSCA orchestrator processing the CSAR file.
- 3471 • a yaml (.yaml or .yml) file at the root of the archive. The yaml file being a valid tosca definition  
3472 template that **MUST** define a metadata section where `template_name` and `template_version` are  
3473 required.

3474 The CSAR file may contain other directories with arbitrary names and contents. Note that in contrast to  
3475 the TOSCA 1.0 specification, it is not required to put TOSCA definitions files into a special “Definitions”  
3476 directory, but definitions YAML files can be placed into any directory within the CSAR file.

### 6.2 TOSCA Meta File

3477

3478 The **TOSCA.meta** file structure follows the exact same syntax as defined in the TOSCA 1.0 specification.  
3479 However, it is only required to include `block_0` (see section 16.2 in [**TOSCA-1.0**]) with the **Entry-**  
3480 **Definitions** keyword pointing to a valid TOSCA definitions YAML file that a TOSCA orchestrator should  
3481 use as entry for parsing the contents of the overall CSAR file.

3482 Note that it is not required to explicitly list TOSCA definitions files in subsequent blocks of the  
3483 **TOSCA.meta** file, but any TOSCA definitions files besides the one denoted by the **Entry-Definitions**  
3484 keyword can be found by a TOSCA orchestrator by processing respective **imports** statements in the  
3485 entry definitions file (or in recursively imported files).

3486 Note also that any additional artifact files (e.g. scripts, binaries, configuration files) do not have to be  
3487 declared explicitly through blocks in the **TOSCA.meta** file. Instead, such artifacts will be fully described and  
3488 pointed to by relative path names through artifact definitions in one of the TOSCA definitions files  
3489 contained in the CSAR.

3490 Due to the simplified structure of the CSAR file and **TOSCA.meta** file compared to TOSCA 1.0, the **CSAR-**  
3491 **Version** keyword listed in `block_0` of the meta-file is required to denote version **1.1**.

#### 6.2.1 Example

3492

3493 The following listing represents a valid **TOSCA.meta** file according to this TOSCA Simple Profile  
3494 specification.

```
TOSCA-Meta-File-Version: 1.0
CSAR-Version: 1.1
Created-By: OASIS TOSCA TC
Entry-Definitions: definitions/tosca_elk.yaml
```

3495



3496 This **TOSCA.meta** file indicates its simplified TOSCA Simple Profile structure by means of the **CSAR-**  
3497 **Version** keyword with value **1.1**. The **Entry-Definitions** keyword points to a TOSCA definitions  
3498 YAML file with the name **tosca\_elk.yaml** which is contained in a directory called **definitions** within  
3499 the root of the CSAR file.

## 3500 6.3 Archive without TOSCA-Metadata

3501 In case the archive doesn't contains a TOSCA-Metadata directory the archive is required to contains a  
3502 single YAML file at the root of the archive (other templates may exists in sub-directories).

3503 This file must be a valid TOSCA definitions YAML file with the additional restriction that the metadata  
3504 section (as defined in 3.9.3.2) is required and `template_name` and `template_version` metadata are also  
3505 required.

3506 TOSCA processors should recognized this file as being the CSAR Entry-Definitions file. The CSAR-  
3507 Version is defined by the `template_version` metadata section. The Created-By value is defined by the  
3508 `template_author` metadata.

### 3509 6.3.1 Example

3510 The following represents a valid TOSCA template file acting as the CSAR Entry-Definitions file in an  
3511 archive without TOSCA-Metadata directory.

```
tosca_definitions_version: tosca_simple_yaml_1_1

metadata:
  template_name: my_template
  template_author: OASIS TOSCA TC
  template_version: 1.0
```

3512

3513

## 7 TOSCA workflows

3514 TOSCA defines two different kinds of workflows that can be used to deploy (instantiate and start),  
3515 manage at runtime or undeploy (stop and delete) a TOSCA topology: declarative workflows and  
3516 imperative workflows. Declarative workflows are automatically generated by the TOSCA orchestrator  
3517 based on the nodes, relationships, and groups defined in the topology. Imperative workflows are manually  
3518 specified by the author of the topology and allows the specification of any use-case that has not been  
3519 planned in the definition of node and relationships types or for advanced use-case (including reuse of  
3520 existing scripts and workflows).

3521

3522 Workflows can be triggered on deployment of a topology (deploy workflow) on undeployment (undeploy  
3523 workflow) or during runtime, manually, or automatically based on policies defined for the topology.

3524

3525 **Note:** The TOSCA orchestrators will execute a single workflow at a time on a topology to guarantee that  
3526 the defined workflow can be consistent and behave as expected.

### 7.1 Normative workflows

3528 TOSCA defines several normative workflows that are used to operate a Topology. That is, reserved  
3529 names of workflows that should be preserved by TOSCA orchestrators and that, if specified in the  
3530 topology will override the workflow generated by the orchestrator :

- 3531 • **deploy**: is the workflow used to instantiate and perform the initial deployment of the topology.
- 3532 • **undeploy**: is the workflow used to remove all instances of a topology.

#### 7.1.1 Notes

3534 Future versions of the specification will describe the normative naming and declarative generation of  
3535 additional workflows used to operate the topology at runtime.

- 3536 • **scaling workflows**: defined for every scalable nodes or based on scaling policies
- 3537 • **auto-healing workflows**: defined in order to restart nodes that may have failed

### 7.2 Declarative workflows

3539 Declarative workflows are the result of the weaving of topology's node, relationships, and groups  
3540 workflows.

3541 The weaving process generates the workflow of every single node in the topology, insert operations from  
3542 the relationships and groups and finally add ordering consideration. The weaving process will also take  
3543 care of the specific lifecycle of some nodes and the TOSCA orchestrator is responsible to trigger errors or  
3544 warnings in case the weaving cannot be processed or lead to cycles for example.

3545 This section aims to describe and explain how a TOSCA orchestrator will generate a workflow based on  
3546 the topology entities (nodes, relationships and groups).

#### 7.2.1 Notes

3548 This section details specific constraints and considerations that applies during the weaving process.

##### 7.2.1.1 Orchestrator provided nodes lifecycle and weaving

3550 When a node is abstract the orchestrator is responsible for providing a valid matching resources for the  
3551 node in order to deploy the topology. This consideration is also valid for dangling requirements (as they  
3552 represents a quick way to define an actual node).

3553 The lifecycle of such nodes is the responsibility of the orchestrator and they may not answer to the  
3554 normative TOSCA lifecycle. Their workflow is considered as "delegate" and acts as a black-box between  
3555 the initial and started state in the install workflow and the started to deleted states in the uninstall  
3556 workflow.

3557 If a relationship to some of this node defines operations or lifecycle dependency constraint that relies on  
3558 intermediate states, the weaving SHOULD fail and the orchestrator SHOULD raise an error.

## 3559 7.2.2 Relationship impacts on topology weaving

3560 This section explains how relationships impacts the workflow generation to enable the composition of  
3561 complex topologies.

### 3562 7.2.2.1 `tosca.relationships.DependsOn`

3563 The depends on relationship is used to establish a dependency from a node to another. A source node  
3564 that depends on a target node will be created only after the other entity has been started.

#### 3565 7.2.2.2 Note

3566 DependsOn relationship SHOULD not be implemented. Even if the Configure interface can be  
3567 implemented this is not considered as a best-practice. If you need specific implementation, please have a  
3568 look at the ConnectsTo relationship.

#### 3569 7.2.2.2.1 Example DependsOn

3570 This example show the usage of a generic DependsOn relationship between two custom software  
3571 components.

3572

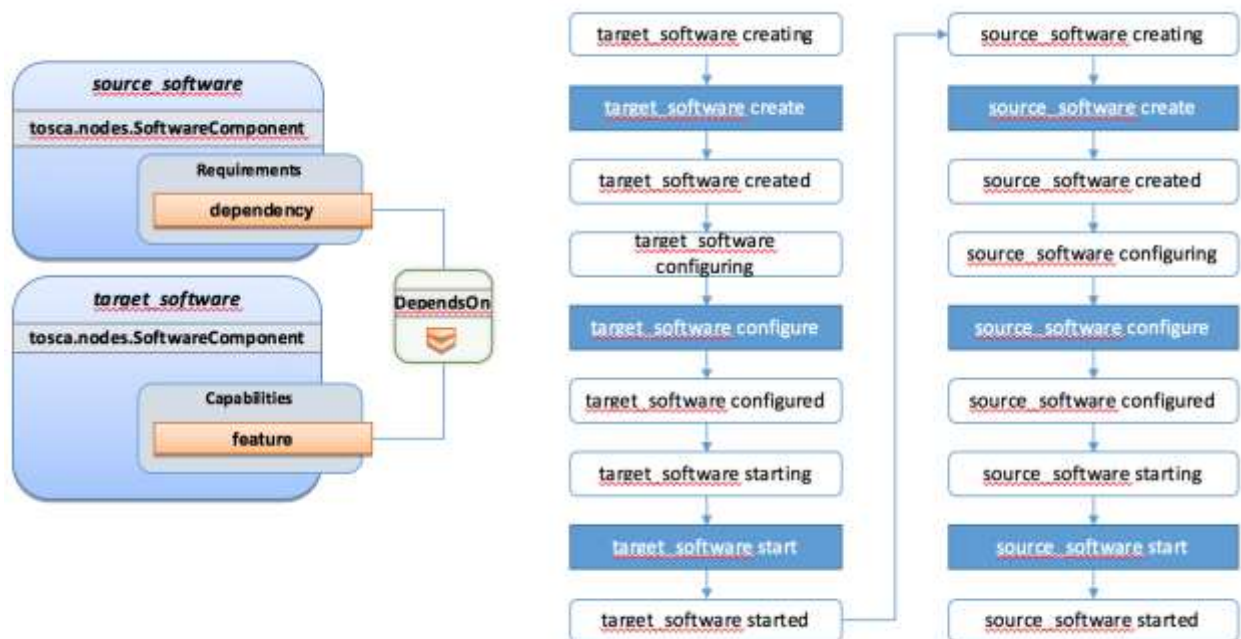

3573

3574 In this example the relationship configure interface doesn't define operations so they don't appear in the  
3575 generated lifecycle.

3576 **7.2.2.3 tosca.relationships.ConnectsTo**

3577 The connects to relationship is similar to the DependsOn relationship except that it is intended to provide  
 3578 an implementation. The difference is more theoretical than practical but helps users to make an actual  
 3579 distinction from a meaning perspective.

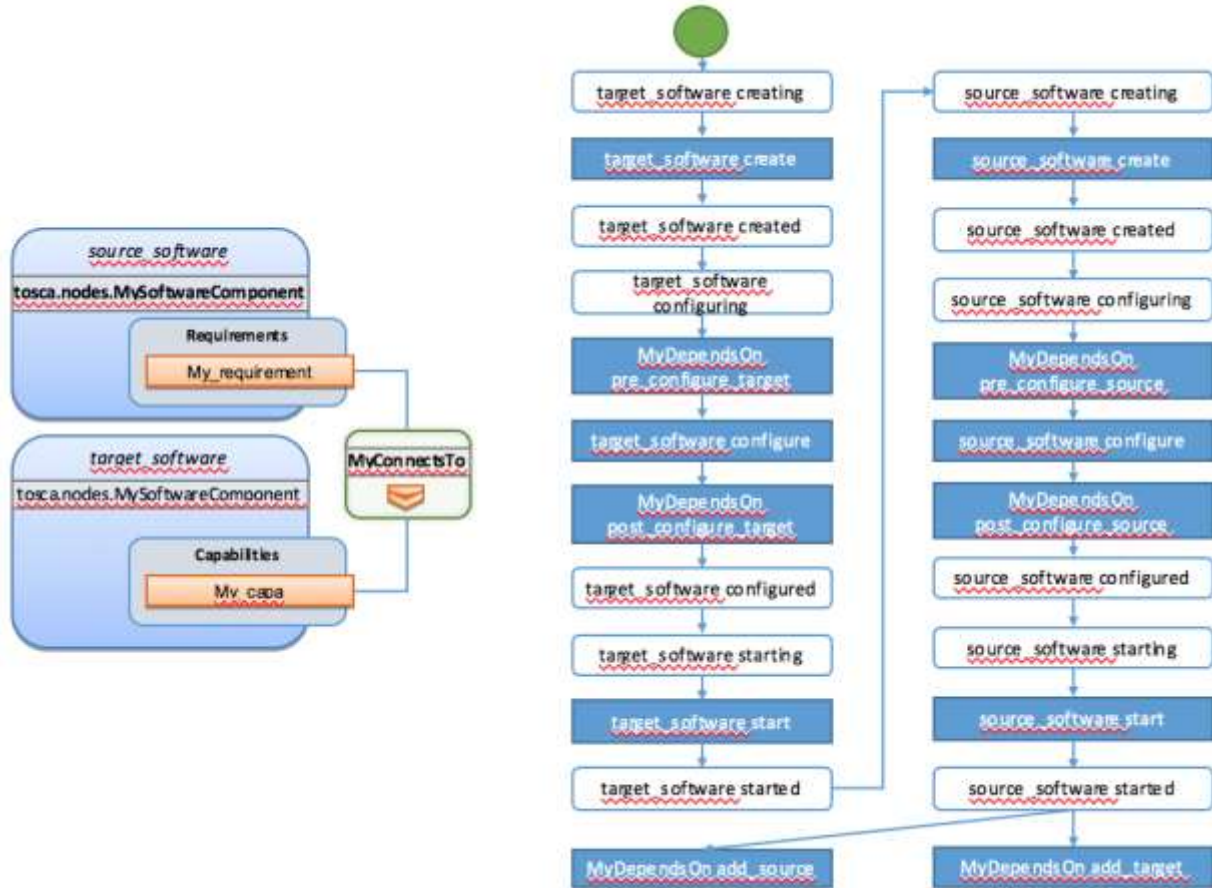

3580

3581 **7.2.2.4 tosca.relationships.HostedOn**

3582 The hosted\_on dependency relationship allows to define a hosting relationship between an entity and  
 3583 another. The hosting relationship has multiple impacts on the workflow and execution:

- 3584 • The implementation artifacts of the source node is executed on the same host as the one of the  
 3585 target node.
- 3586 • The create operation of the source node is executed only once the target node reach the started  
 3587 state.
- 3588 • When multiple nodes are hosted on the same host node, the defined operations will not be  
 3589 executed concurrently even if the theoretical workflow could allow it (actual generated workflow  
 3590 will avoid concurrency).

3591 **7.2.2.4.1 Example Software Component HostedOn Compute**

3592 This example explain the TOSCA weaving operation of a custom SoftwareComponent on a  
 3593 tosca.nodes.Compute instance. The compute node is an orchestrator provided node meaning that it's  
 3594 lifecycle is delegated to the orchestrator. This is a black-box and we just expect a started compute node  
 3595 to be provided by the orchestrator.

3596 The software node lifecycle operations will be executed on the Compute node (host) instance.

3597

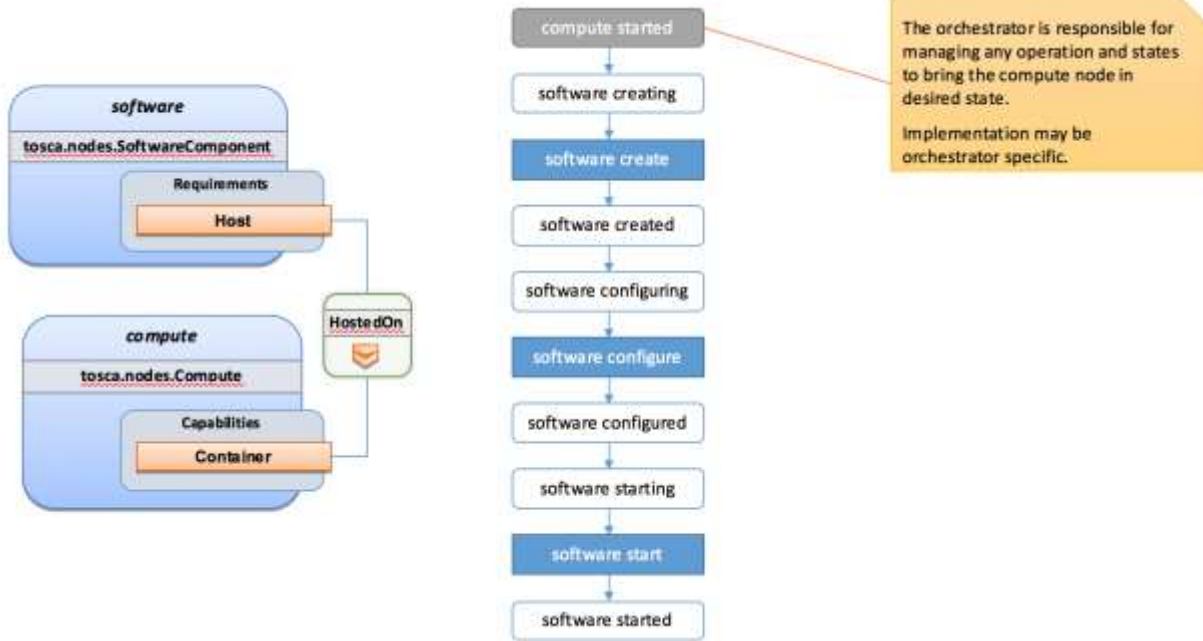

3598

### 3599 7.2.2.4.2 Example Software Component HostedOn Software Component

3600 Tosca allows some more complex hosting scenarios where a software component could be hosted on  
3601 another software component.

3602

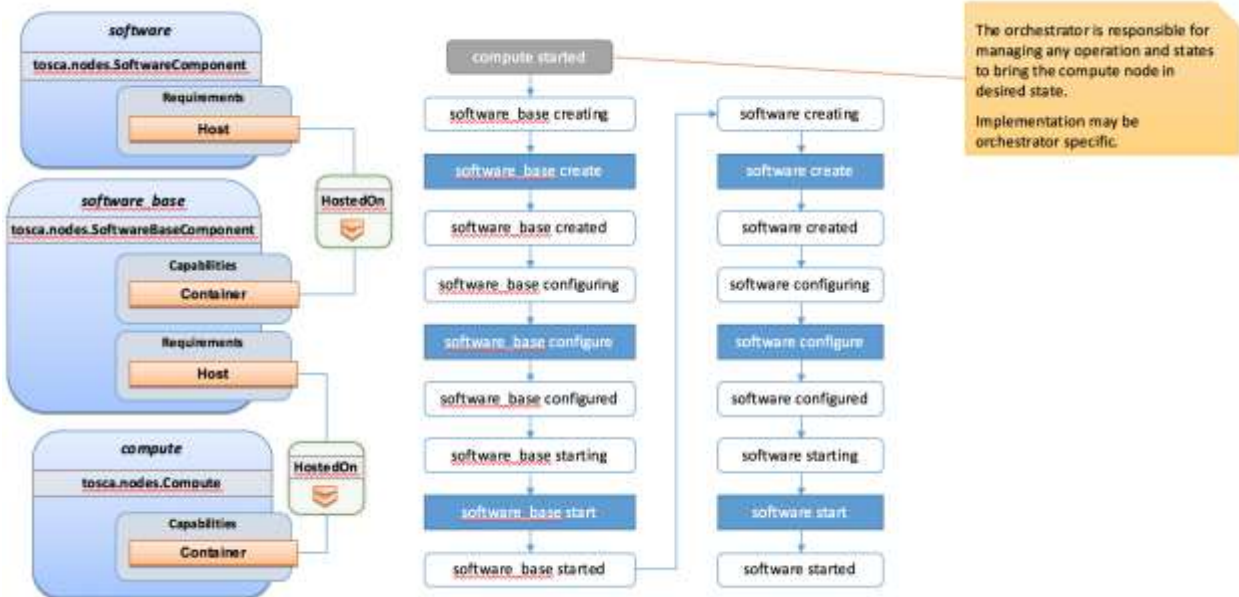

3603

3604 In such scenarios the software create operation is triggered only once the software\_base node has  
3605 reached the started state.

### 3606 7.2.2.4.3 Example 2 Software Components HostedOn Compute

3607 This example illustrate concurrency constraint introduced by the management of multiple nodes on a  
3608 single compute.

## 3609 7.2.3 Limitations

### 3610 7.2.3.1 Hosted nodes concurrency

3611 TOSCA implementation currently does not allow concurrent executions of scripts implementation artifacts  
3612 (shell, python, ansible, puppet, chef etc.) on a given host. This limitation is not applied on multiple hosts.  
3613 This limitation is expressed through the HostedOn relationship limitation expressing that when multiple  
3614 components are hosted on a given host node then their operations will not be performed concurrently  
3615 (generated workflow will ensure that operations are not concurrent).

### 3616 7.2.3.2 Dependent nodes concurrency

3617 When a node depends on another node no operations will be processed concurrently. In some situations,  
3618 especially when the two nodes lies on different hosts we could expect the create operation to be executed  
3619 concurrently for performance optimization purpose. The current version of the specification will allow to  
3620 use imperative workflows to solve this use-case. However, this scenario is one of the scenario that we  
3621 want to improve and handle in the future through declarative workflows.

### 3622 7.2.3.3 Target operations and get\_attribute on source

3623 The current ConnectsTo workflow implies that the target node is started before the source node is even  
3624 created. This means that pre\_configure\_target and post\_configure\_target operations cannot use any  
3625 input based on source attribute. It is however possible to refer to get\_property inputs based on source  
3626 properties. For advanced configurations the add\_source operation should be used.

3627 Note also that future plans on declarative workflows improvements aims to solve this kind of issues while  
3628 it is currently possible to use imperative workflows.

## 3629 7.3 Imperative workflows

3630 Imperative workflows are user defined and can define any really specific constraints and ordering of  
3631 activities. They are really flexible and powerful and can be used for any complex use-case that cannot be  
3632 solved in declarative workflows. However, they provide less reusability as they are defined for a specific  
3633 topology rather than being dynamically generated based on the topology content.

### 3634 7.3.1 Defining sequence of operations in an imperative workflow

3635 Imperative workflow grammar defines two ways to define the sequence of operations in an imperative  
3636 workflow:

- 3637 • Leverage the **on\_success** definition to define the next steps that will be executed in parallel.
- 3638 • Leverage a sequence of activity in a step.

#### 3639 7.3.1.1 Using on\_success to define steps ordering

3640 The graph of workflow steps is build based on the values of **on\_success** elements of the various defined  
3641 steps. The graph is built based on the following rules:

- 3642 • All steps that defines an **on\_success** operation must be executed before the next step can be  
3643 executed. So if A and C defines an **on\_success** operation to B, then B will be executed only  
3644 when both A and C have been successfully executed.
- 3645 • The multiple nodes defined by an **on\_success** construct can be executed in parallel.

- 3646
- 3647
- 3648
- 3649
- Every step that doesn't have any predecessor is considered as an initial step and can run in parallel.
  - Every step that doesn't define any successor is considered as final. When all the final nodes executions are completed then the workflow is considered as completed.

3650 **7.3.1.1.1 Example**

3651 The following example defines multiple steps and the **on\_success** relationship between them.

3652

```
topology_template:
  workflows:
    deploy:
      description: Workflow to deploy the application
      steps:
        A:
          on_success:
            - B
            - C
        B:
          on_success:
            - D
        C:
          on_success:
            - D
        D:
        E:
          on_success:
            - C
            - F
        F:
```

3653 The following schema is the visualization of the above definition in term of sequencing of the steps.

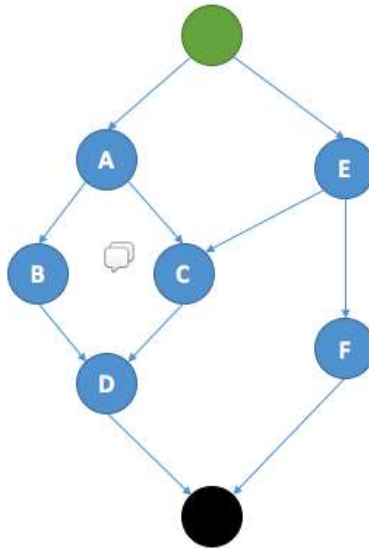

3654

### 3655 7.3.1.2 Define a sequence of activity on the same element

3656 The step definition of a TOSCA imperative workflow allows multiple activities to be defined :

3657

```

workflows:
  my_workflow:
    steps:
      create_my_node:
        target: my_node
        activities:
          - set_state: creating
          - call_operation: tosca.interfaces.node.lifecycle.Standard.create
          - set_state: created
  
```

3658 The sequence defined here defines three different activities that will be performed in a sequential way.

3659 This is just equivalent to writing multiple steps chained by an on\_success together :

3660

3661

```

workflows:
  my_workflow:
    steps:
      creating_my_node:
        target: my_node
        activities:
          - set_state: creating
        on_success: create_my_node
      create_my_node:
        target: my_node
  
```



```

activities:
  - call_operation: tosca.interfaces.node.lifecycle.Standard.create
  on_success: created_my_node
created_my_node:
  target: my_node
  activities:
    - set_state: created

```

3662

3663 In both situations the resulting workflow is a sequence of activities:

3664

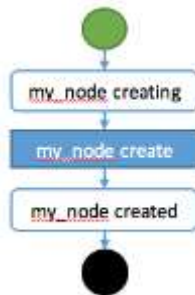

3665

### 3666 7.3.2 Definition of a simple workflow

3667 Imperative workflow allow user to define custom workflows allowing them to add operations that are not  
 3668 normative, or for example, to execute some operations in parallel when TOSCA would have performed  
 3669 sequential execution.

3670

3671 As Imperative workflows are related to a topology, adding a workflow is as simple as adding a workflows  
 3672 section to your topology template and specifying the workflow and the steps that compose it.

#### 3673 7.3.2.1 Example: Adding a non-normative custom workflow

3674 This sample topology add a very simple custom workflow to trigger the mysql backup operation.

```

topology_template:
  node_templates:
    my_server:
      type: tosca.nodes.Compute
    mysql:
      type: tosca.nodes.DBMS.MySQL
      requirements:
        - host: my_server
      interfaces:
        tosca.interfaces.nodes.custom.Backup:
          operations:
            backup: backup.sh
  workflows:

```

```

backup:
  description: Performs a snapshot of the MySQL data.
  steps:
    my_step:
      target: mysql
      activities:
        - call_operation: tosca.interfaces.nodes.custom.Backup.backup

```

3675

3676 In such topology the TOSCA container will still use declarative workflow to generate the deploy and  
 3677 undeploy workflows as they are not specified and a backup workflow will be available for user to trigger.

### 3678 7.3.2.2 Example: Creating two nodes hosted on the same compute in parallel

3679 TOSCA declarative workflow generation constraint the workflow so that no operations are called in  
 3680 parallel on the same host. Looking at the following topology this means that the mysql and tomcat nodes  
 3681 will not be created in parallel but sequentially. This is fine in most of the situations as packet managers  
 3682 like apt or yum doesn't not support concurrency, however if both create operations performs a download  
 3683 of zip package from a server most of people will hope to do that in parallel in order to optimize throughput.

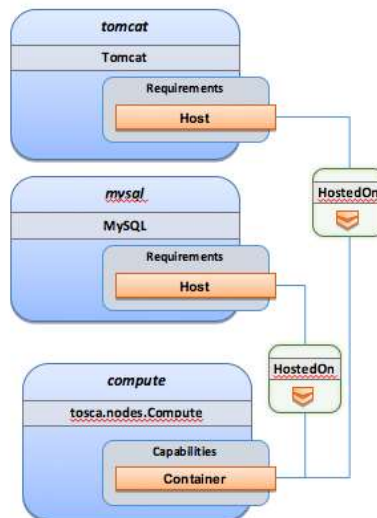

3684

3685 Imperative workflows can help to solve this issue. Based on the above topology we will design a workflow  
 3686 that will create tomcat and mysql in parallel but we will also ensure that tomcat is started after mysql is  
 3687 started even if no relationship is defined between the components:

3688

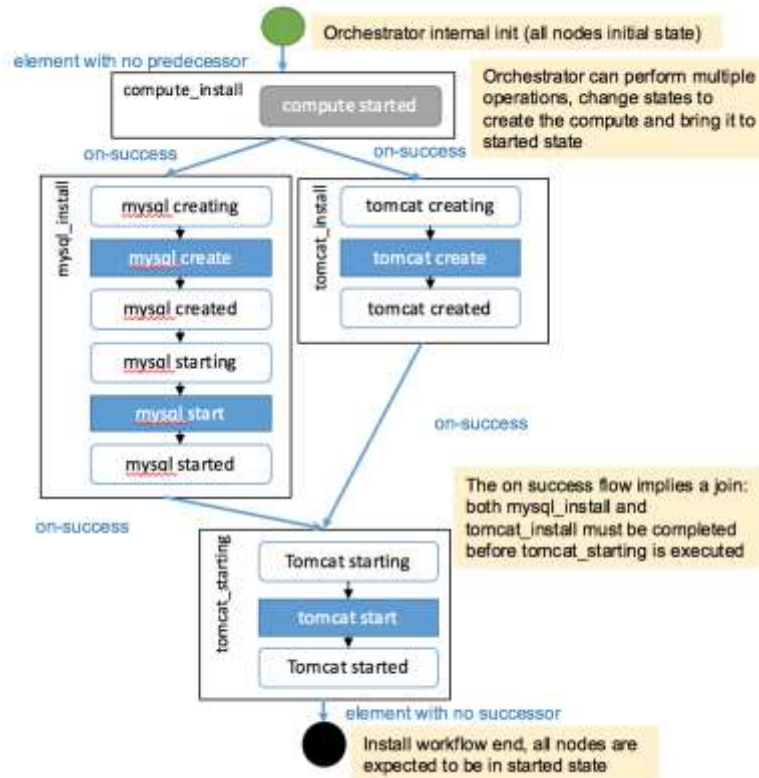

3689

3690

3691 To achieve such workflow, the following topology will be defined:

3692

```

topology_template:
  node_templates:
    my_server:
      type: tosca.nodes.Compute
    mysql:
      type: tosca.nodes.DBMS.MySQL
      requirements:
        - host: my_server
    tomcat:
      type: tosca.nodes.WebServer.Tomcat
      requirements:
        - host: my_server
  workflows:
    deploy:
      description: Override the TOSCA declarative workflow with the following.
      steps:
        compute_install
        target: my_server

```

```

activities:
  - delegate: deploy
on_success:
  - mysql_install
  - tomcat_install
tomcat_install:
  target: tomcat
  activities:
    - set_state: creating
    - call_operation: tosca.interfaces.node.lifecycle.Standard.create
    - set_state: created
  on_success:
    - tomcat_starting
mysql_install:
  target: mysql
  activities:
    - set_state: creating
    - call_operation: tosca.interfaces.node.lifecycle.Standard.create
    - set_state: created
    - set_state: starting
    - call_operation: tosca.interfaces.node.lifecycle.Standard.start
    - set_state: started
  on_success:
    - tomcat_starting
tomcat_starting:
  target: tomcat
  activities:
    - set_state: starting
    - call_operation: tosca.interfaces.node.lifecycle.Standard.start
    - set_state: started

```

3693

### 3694 **7.3.3 Specifying preconditions to a workflow**

3695 Pre conditions allows the TOSCA orchestrator to determine if a workflow can be executed based on the  
 3696 states and attribute values of the topology's node. Preconditions must be added to the initial workflow.

#### 3697 **7.3.3.1 Example : adding precondition to custom backup workflow**

3698 In this example we will use precondition so that we make sure that the mysql node is in the correct state  
 3699 for a backup.

```

topology_template:
  node_templates:
    my_server:
      type: toska.nodes.Compute
    mysql:
      type: toska.nodes.DBMS.MySQL
      requirements:
        - host: my_server
      interfaces:
        toska.interfaces.nodes.custom.Backup:
          operations:
            backup: backup.sh
  workflows:
    backup:
      description: Performs a snapshot of the MySQL data.
      preconditions:
        - target: my_server
          condition:
            - assert:
              - state: [{equal: available}]
        - target: mysql
          condition:
            - assert:
              - state: [{valid_values: [started, available]}]
              - my_attribute: [{equal: ready }]
      steps:
        my_step:
          target: mysql
          activities:
            - call_operation: toska.interfaces.nodes.custom.Backup.backup

```

3700 When the backup workflow will be triggered (by user or policy) the TOSCA engine will first check that  
3701 preconditions are fulfilled. In this situation the engine will check that *my\_server* node is in *available* state  
3702 AND that *mysql* node is in *started* OR *available* states AND that *mysql my\_attribute* value is equal to  
3703 *ready*.

### 3704 7.3.4 Workflow reusability

3705 TOSCA allows the reusability of a workflow in other workflows. Such concepts can be achieved thanks to  
3706 the inline activity.

#### 3707 7.3.4.1 Reusing a workflow to build multiple workflows

3708 The following example show how a workflow can inline an existing workflow and reuse it.

3709

```

topology_template:
  node_templates:
    my_server:
      type: tosca.nodes.Compute
    mysql:
      type: tosca.nodes.DBMS.MySQL
      requirements:
        - host: my_server
      interfaces:
        tosca.interfaces.nodes.custom.Backup:
          operations:
            backup: backup.sh
  workflows:
    start_mysql:
      steps:
        start_mysql:
          target: mysql
          activities :
            - set_state: starting
            - call_operation: tosca.interfaces.node.lifecycle.Standard.start
            - set_state: started
    stop_mysql:
      steps:
        stop_mysql:
          target: mysql
          activities:
            - set_state: stopping
            - call_operation: tosca.interfaces.node.lifecycle.Standard.stop
            - set_state: stopped

  backup:
    description: Performs a snapshot of the MySQL data.
    preconditions:
      - target: my_server
        condition:
          - assert:
              - state: [{equal: available}]
      - target: mysql
        condition:
          - assert:
              - state: [{valid_values: [started, available]}]

```

```

    - my_attribute: [{equal: ready }]
  steps:
    backup_step:
      activities:
        - inline: stop
        - call_operation: toska.interfaces.nodes.custom.Backup.backup
        - inline: start
    restart:
      steps:
        backup_step:
          activities:
            - inline: stop
            - inline: start

```

3710

3711 The example above defines three workflows and show how the start\_mysql and stop\_mysql workflows  
 3712 are reused in the backup and restart workflows.

3713 Inlined workflows are inlined sequentially in the existing workflow for example the backup workflow would  
 3714 look like this:

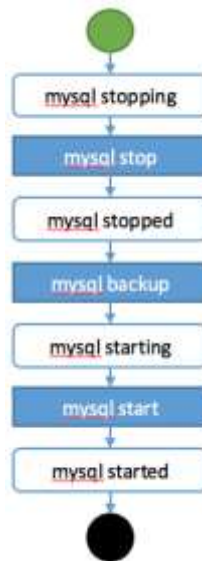

3715

### 3716 7.3.4.2 Inlining a complex workflow

3717 It is possible of course to inline more complex workflows. The following example defines an inlined  
 3718 workflows with multiple steps including concurrent steps:

3719

```

topology_template:
  workflows:
    inlined_wf:
      steps:

```

```
A:
  target: node_a
  activities:
    - call_operation: a
  on_success:
    - B
    - C
B:
  target: node_a
  activities:
    - call_operation: b
  on_success:
    - D
C:
  target: node_a
  activities:
    - call_operation: c
  on_success:
    - D
D:
  target: node_a
  activities:
    - call_operation: d
E:
  target: node_a
  activities:
    - call_operation: e
  on_success:
    - C
    - F
F:
  target: node_a
  activities:
    - call_operation: f
main_workflow:
  steps:
    G:
      target: node_a
      activities:
        - set_state: initial
        - inline: inlined_wf
```



```
- set_state: available
```

3720

3721 To describe the following workflow:

3722

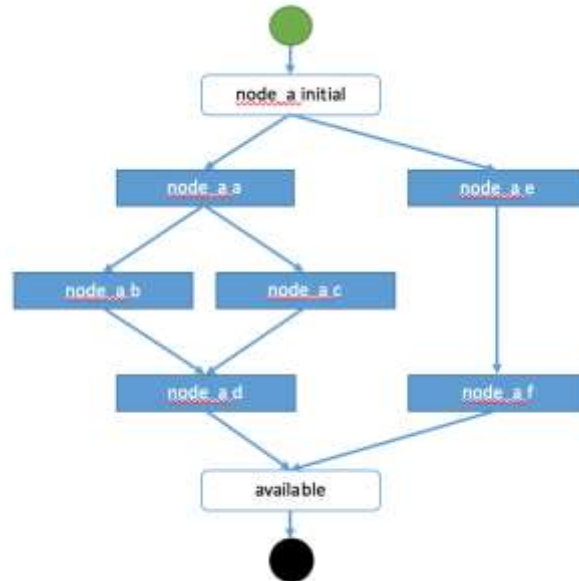

3723

### 3724 7.3.5 Defining conditional logic on some part of the workflow

3725 Preconditions are used to validate if the workflow should be executed only for the initial workflow. If a  
3726 workflow that is inlined defines some preconditions these preconditions will be used at the instance level  
3727 to define if the operations should be executed or not on the defined instance.

3728

3729 This construct can be used to filter some steps on a specific instance or under some specific  
3730 circumstances or topology state.

3731

```
topology_template:
  node_templates:
    my_server:
      type: tosca.nodes.Compute
    cluster:
      type: tosca.nodes.DBMS.Cluster
      requirements:
        - host: my_server
      interfaces:
        tosca.interfaces.nodes.custom.Backup:
          operations:
            backup: backup.sh
```

```

workflows:
  backup:
    description: Performs a snapshot of the MySQL data.
    preconditions:
      - target: my_server
        condition:
          - assert:
              - state: [{equal: available}]
      - target: mysql
        condition:
          - assert:
              - state: [{valid_values: [started, available]}]
              - my_attribute: [{equal: ready }]
    steps:
      backup_step:
        target: cluster
        filter: # filter is a list of clauses. Matching between clauses is and.
          - or: # only one of sub-clauses must be true.
              - assert:
                  - foo: [{equals: true}]
              - assert:
                  - bar: [{greater_than: 2}, {less_than: 20}]
        activities:
          - call_operation: toska.interfaces.nodes.custom.Backup.backup

```

3732

### 3733 7.3.6 Define inputs for a workflow

3734 Inputs can be defined in a workflow and will be provided in the execution context of the workflow. If an  
 3735 operation defines a `get_input` function on one of its parameter the input will be retrieved from the workflow  
 3736 input, and if not found from the topology inputs.

3737

3738 Workflow inputs will never be configured from policy triggered workflows and SHOULD be used only for  
 3739 user triggered workflows. Of course operations can still refer to topology inputs or template properties or  
 3740 attributes even in the context of a policy triggered workflow.

#### 3741 7.3.6.1 Example

```

topology_template:
  node_templates:
    my_server:
      type: toska.nodes.Compute
    mysql:
      type: toska.nodes.DBMS.MySQL

```

```

requirements:
  - host: my_server
interfaces:
  tosca.interfaces.nodes.custom.Backup:
    operations:
      backup:
        implementation: backup.sh
        inputs:
          storage_url: { get_input: storage_url }
workflows:
  backup:
    description: Performs a snapshot of the MySQL data.
    preconditions:
      - target: my_server
        valid_states: [available]
      - target: mysql
        valid_states: [started, available]
    attributes:
      my_attribute: [ready]
    inputs:
      storage_url:
        type: string
    steps:
      my_step:
        target: mysql
        activities:
          - call_operation: tosca.interfaces.nodes.custom.Backup.backup

```

3742

3743 To trigger such a workflow, the TOSCA engine must allow user to provide inputs that match the given  
3744 definitions.

### 3745 **7.3.7 Handle operation failure**

3746 By default, failure of any activity of the workflow will result in the failure of the workflow and will results in  
3747 stopping the steps to be executed.

3748

3749 Exception: uninstall workflow operation failure SHOULD not prevent the other operations of the workflow  
3750 to run (a failure in an uninstall script SHOULD not prevent from releasing resources from the cloud).

3751

3752 For any workflow other than install and uninstall failures may leave the topology in an unknown state. In  
3753 such situation the TOSCA engine may not be able to orchestrate the deployment. Implementation of  
3754 **on\_failure** construct allows to execute rollback operations and reset the state of the affected entities  
3755 back to an orchestrator known state.

3756 **7.3.7.1 Example**

```
topology_template:
  node_templates:
    my_server:
      type: tosca.nodes.Compute
    mysql:
      type: tosca.nodes.DBMS.MySQL
      requirements:
        - host: my_server
      interfaces:
        tosca.interfaces.nodes.custom.Backup:
          operations:
            backup:
              implementation: backup.sh
              inputs:
                storage_url: { get_input: storage_url }
  workflows:
    backup:
      steps:
        backup_step:
          target: mysql
          activities:
            - set_state: backing_up # this state is not a TOSCA known state
            - call_operation: tosca.interfaces.nodes.custom.Backup.backup
            - set_state: available # this state is known by TOSCA orchestrator
          on_failure:
            - rollback_step
        rollback_step:
          target: mysql
          activities:
            - call_operation: tosca.interfaces.nodes.custom.Backup.backup
            - set_state: available # this state is known by TOSCA orchestrator
```

3757

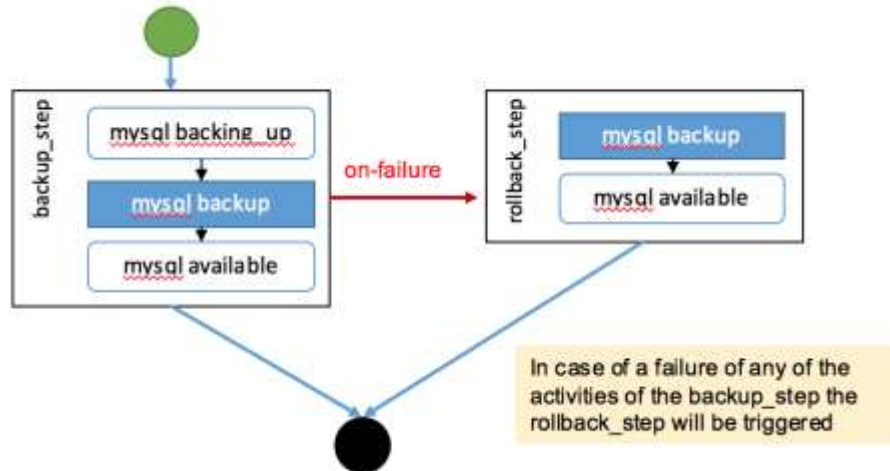

3758  
3759

## 3760 7.4 Making declarative more flexible and imperative more generic

3761 TOSCA simple profile 1.1 version provides the genericity and reusability of declarative workflows that is  
3762 designed to address most of use-cases and the flexibility of imperative workflows to address more  
3763 complex or specific use-cases.

3764

3765 Each approach has some pros and cons and we are working so that the next versions of the specification  
3766 can improve the workflow usages to try to allow more flexibility in a more generic way. Two non-exclusive  
3767 leads are currently being discussed within the working group and may be included in the future versions  
3768 of the specification.

- 3769 • Improvement of the declarative workflows in order to allow people to extend the weaving logic of  
3770 TOSCA to fit some specific need.
- 3771 • Improvement of the imperative workflows in order to allow partial imperative workflows to be  
3772 automatically included in declarative workflows based on specific constraints on the topology  
3773 elements.

3774 Implementation of the improvements will be done by adding some elements to the specification and will  
3775 not break compatibility with the current specification.

### 3776 7.4.1.1 Notes

- 3777 • The weaving improvement section is a Work in Progress and is not final in 1.1 version. The  
3778 elements in this section are incomplete and may be subject to change in next specification  
3779 version.
- 3780 • Moreover, the weaving improvements is one of the track of improvements. As describe improving  
3781 the reusability of imperative workflow is another track (that may both co-exists in next  
3782 specifications).

## 3783 7.4.2 Weaving improvements

3784 Making declarative better experimental option.

### 3785 7.4.2.1 Node lifecycle definition

3786 Node workflow is defined at the node type level. The node workflow definition is used to generate the  
3787 declarative workflow of a given node.

3788 The `tosca.nodes.Root` type defines workflow steps for both the install workflow (used to instantiate or  
3789 deploy a topology) and the uninstall workflow (used to destroy or undeploy a topology). The workflow is  
3790 defined as follows:

3791

```
node_types:
  tosca.nodes.Root:
    workflows:
      install:
        steps:
          install_sequence:
            activities:
              - set_state: creating
              - call_operation: tosca.interfaces.node.lifecycle.Standard.create
              - set_state: created
              - set_state: configuring
              - call_operation:
                tosca.interfaces.node.lifecycle.Standard.configure
              - set_state: configured
              - set_state: starting
              - call_operation: tosca.interfaces.node.lifecycle.Standard.start
              - set_state: started
          uninstall:
            steps:
              uninstall_sequence:
                activities:
                  - set_state: stopping
                  - call_operation: tosca.interfaces.node.lifecycle.Standard.stop
                  - set_state: stopped
                  - set_state: deleting
                  - call_operation: tosca.interfaces.node.lifecycle.Standard.delete
                  - set_state: deleted
```

3792

#### 3793 **7.4.2.2 Relationship lifecycle and weaving**

3794 While the workflow of a single node is quite simple the TOSCA weaving process is the real key element of  
3795 declarative workflows. The process of weaving consist of the ability to create complex management  
3796 workflows including dependency management in execution order between node operations, injection of  
3797 operations to process specific instruction related to the connection to other nodes based the relationships  
3798 and groups defined in a topology.

3799

3800 This section describes the relationship weaving and how the description at a template level can be  
3801 translated on an instance level.

```

relationship_types:
  tosca.relationships.ConnectsTo:
    workflow:
      install: # name of the workflow for wich the weaving has to be taken in
account
      source_weaving: # Instruct how to weave some tasks on the source workflow
(executed on SOURCE instance)
        - after: configuring # instruct that this operation should be weaved
after the target reach configuring state
          wait_target: created # add a join from a state of the target
          activity:
tosca.interfaces.relationships.Configure.pre_configure_source
        - before: configured # instruct that this operation should be weaved
before the target reach configured state
          activity:
tosca.interfaces.relationships.Configure.post_configure_source
        - before: starting
          wait_target: started # add a join from a state of the target
        - after: started
          activity: tosca.interfaces.relationships.Configure.add_target
      target_weaving: # Instruct how to weave some tasks on the target workflow
(executed on TARGET instance)
        - after: configuring # instruct that this operation should be weaved
after the target reach configuring state
          after_source: created # add a join from a state of the source
          activity:
tosca.interfaces.relationships.Configure.pre_configure_target
        - before: configured # instruct that this operation should be weaved
before the target reach configured state
          activity:
tosca.interfaces.relationships.Configure.post_configure_target
        - after: started
          activity: tosca.interfaces.relationships.Configure.add_source

```

3803

## 8 TOSCA networking

3804 Except for the examples, this section is **normative** and describes how to express and control the  
3805 application centric network semantics available in TOSCA.

### 8.1 Networking and Service Template Portability

3807 TOSCA Service Templates are application centric in the sense that they focus on describing application  
3808 components in terms of their requirements and interrelationships. In order to provide cloud portability, it is  
3809 important that a TOSCA Service Template avoid cloud specific requirements and details. However, at the  
3810 same time, TOSCA must provide the expressiveness to control the mapping of software component  
3811 connectivity to the network constructs of the hosting cloud.

3812 TOSCA Networking takes the following approach.

- 3813 1. The application component connectivity semantics and expressed in terms of Requirements and  
3814 Capabilities and the relationships between these. Service Template authors are able to express  
3815 the interconnectivity requirements of their software components in an abstract, declarative, and  
3816 thus highly portable manner.
- 3817 2. The information provided in TOSCA is complete enough for a TOSCA implementation to fulfill the  
3818 application component network requirements declaratively (i.e., it contains information such as  
3819 communication initiation and layer 4 port specifications) so that the required network semantics  
3820 can be realized on arbitrary network infrastructures.
- 3821 3. TOSCA Networking provides full control of the mapping of software component interconnectivity  
3822 to the networking constructs of the hosting cloud network independently of the Service Template,  
3823 providing the required separation between application and network semantics to preserve Service  
3824 Template portability.
- 3825 4. Service Template authors have the choice of specifying application component networking  
3826 requirements in the Service Template or completely separating the application component to  
3827 network mapping into a separate document. This allows application components with explicit  
3828 network requirements to express them while allowing users to control the complete mapping for  
3829 all software components which may not have specific requirements. Usage of these two  
3830 approaches is possible simultaneously and required to avoid having to re-write components  
3831 network semantics as arbitrary sets of components are assembled into Service Templates.
- 3832 5. Defining a set of network semantics which are expressive enough to address the most common  
3833 application connectivity requirements while avoiding dependencies on specific network  
3834 technologies and constructs. Service Template authors and cloud providers are able to express  
3835 unique/non-portable semantics by defining their own specialized network Requirements and  
3836 Capabilities.

### 8.2 Connectivity semantics

3838 TOSCA's application centric approach includes the modeling of network connectivity semantics from an  
3839 application component connectivity perspective. The basic premise is that applications contain  
3840 components which need to communicate with other components using one or more endpoints over a  
3841 network stack such as TCP/IP, where connectivity between two components is expressed as a <source  
3842 component, source address, source port, target component, target address, target port> tuple. Note that  
3843 source and target components are added to the traditional 4 tuple to provide the application centric  
3844 information, mapping the network to the source or target component involved in the connectivity.

3845

3846 Software components are expressed as Node Types in TOSCA which can express virtually any kind of  
3847 concept in a TOSCA model. Node Types offering network based functions can model their connectivity  
3848 using a special Endpoint Capability, [tosca.capabilities.Endpoint](#), designed for this purpose. Node Types



3849 which require an Endpoint can specify this as a TOSCA requirement. A special Relationship Type,  
3850 `tosca.relationships.ConnectsTo`, is used to implicitly or explicitly relate the source Node Type's endpoint  
3851 to the required endpoint in the target node type. Since `tosca.capabilities.Endpoint` and  
3852 `tosca.relationships.ConnectsTo` are TOSCA types, they can be used in templates and extended by  
3853 subclassing in the usual ways, thus allowing the expression of additional semantics as needed.

3854 The following diagram shows how the TOSCA node, capability and relationship types enable modeling  
3855 the application layer decoupled from the network model intersecting at the Compute node using the  
3856 [Bindable](#) capability type.

3857 As you can see, the Port node type effectively acts a broker node between the Network node description

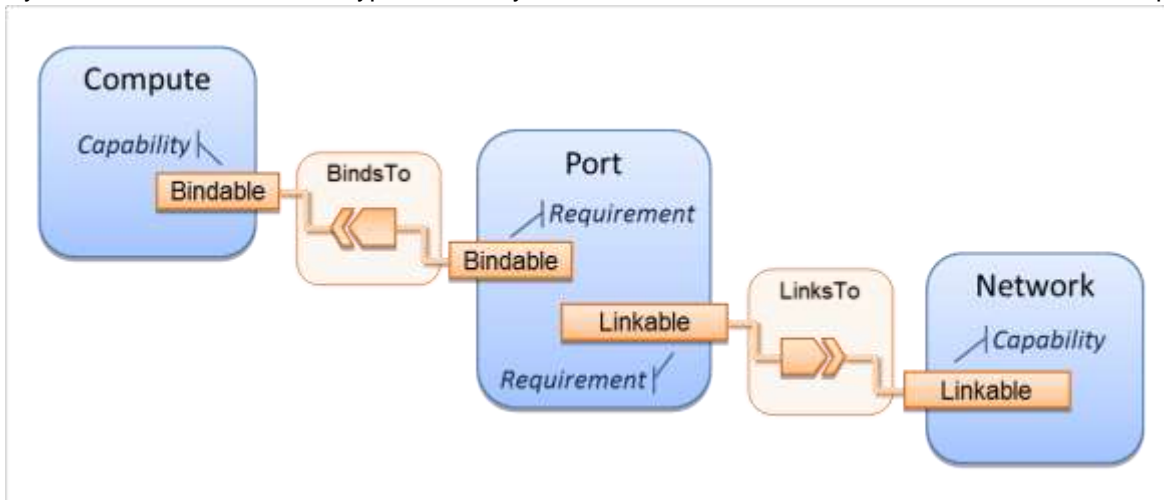

3858 and a host Compute node of an application.

## 3859 **8.3 Expressing connectivity semantics**

3860 This section describes how TOSCA supports the typical client/server and group communication  
3861 semantics found in application architectures.

### 3862 **8.3.1 Connection initiation semantics**

3863 The `tosca.relationships.ConnectsTo` expresses that requirement that a source application component  
3864 needs to be able to communicate with a target software component to consume the services of the target.  
3865 `ConnectTo` is a component interdependency semantic in the most general sense and does not try imply  
3866 how the communication between the source and target components is physically realized.

3867  
3868 Application component intercommunication typically has conventions regarding which component(s)  
3869 initiate the communication. Connection initiation semantics are specified in [tosca.capabilities.Endpoint](#).  
3870 Endpoints at each end of the [tosca.relationships.ConnectsTo](#) must indicate identical connection initiation  
3871 semantics.

3872

3873 The following sections describe the normative connection initiation semantics for the  
3874 `tosca.relationships.ConnectsTo` Relationship Type.

#### 3875 **8.3.1.1 Source to Target**

3876 The Source to Target communication initiation semantic is the most common case where the source  
3877 component initiates communication with the target component in order to fulfill an instance of the  
3878 `tosca.relationships.ConnectsTo` relationship. The typical case is a “client” component connecting to a  
3879 “server” component where the client initiates a stream oriented connection to a pre-defined transport  
3880 specific port or set of ports.

3881  
3882 It is the responsibility of the TOSCA implementation to ensure the source component has a suitable  
3883 network path to the target component and that the ports specified in the respective  
3884 [tosca.capabilities.Endpoint](#) are not blocked. The TOSCA implementation may only represent state of the  
3885 `tosca.relationships.ConnectsTo` relationship as fulfilled after the actual network communication is enabled  
3886 and the source and target components are in their operational states.

3887  
3888 Note that the connection initiation semantic only impacts the fulfillment of the actual connectivity and does  
3889 not impact the node traversal order implied by the `tosca.relationships.ConnectsTo` Relationship Type.

### 3890 **8.3.1.2 Target to Source**

3891 The Target to Source communication initiation semantic is a less common case where the target  
3892 component initiates communication with the source component in order to fulfill an instance of the  
3893 `tosca.relationships.ConnectsTo` relationship. This “reverse” connection initiation direction is typically  
3894 required due to some technical requirements of the components or protocols involved, such as the  
3895 requirement that SSH must only be initiated from target component in order to fulfill the services required  
3896 by the source component.

3897  
3898 It is the responsibility of the TOSCA implementation to ensure the source component has a suitable  
3899 network path to the target component and that the ports specified in the respective  
3900 `tosca.capabilities.Endpoint` are not blocked. The TOSCA implementation may only represent state of the  
3901 `tosca.relationships.ConnectsTo` relationship as fulfilled after the actual network communication is enabled  
3902 and the source and target components are in their operational states.

3903  
3904 Note that the connection initiation semantic only impacts the fulfillment of the actual connectivity and does  
3905 not impact the node traversal order implied by the `tosca.relationships.ConnectsTo` Relationship Type.

### 3906 **8.3.1.3 Peer-to-Peer**

3907 The Peer-to-Peer communication initiation semantic allows any member of a group to initiate  
3908 communication with any other member of the same group at any time. This semantic typically appears in  
3909 clustering and distributed services where there is redundancy of components or services.

3910  
3911 It is the responsibility of the TOSCA implementation to ensure the source component has a suitable  
3912 network path between all the member component instances and that the ports specified in the respective  
3913 `tosca.capabilities.Endpoint` are not blocked, and the appropriate multicast communication, if necessary,  
3914 enabled. The TOSCA implementation may only represent state of the `tosca.relationships.ConnectsTo`  
3915 relationship as fulfilled after the actual network communication is enabled such that at least one-member  
3916 component of the group may reach any other member component of the group.

3917  
3918 Endpoints specifying the Peer-to-Peer initiation semantic need not be related with a  
3919 `tosca.relationships.ConnectsTo` relationship for the common case where the same set of component  
3920 instances must communicate with each other.

3921  
3922 Note that the connection initiation semantic only impacts the fulfillment of the actual connectivity and does  
3923 not impact the node traversal order implied by the `tosca.relationships.ConnectsTo` Relationship Type.

## 3924 **8.3.2 Specifying layer 4 ports**

3925 TOSCA Service Templates must express enough details about application component  
3926 intercommunication to enable TOSCA implementations to fulfill these communication semantics in the  
3927 network infrastructure. TOSCA currently focuses on TCP/IP as this is the most pervasive in today’s cloud

3928 infrastructures. The layer 4 ports required for application component intercommunication are specified in  
3929 `tosca.capabilities.Endpoint`. The union of the port specifications of both the source and target  
3930 `tosca.capabilities.Endpoint` which are part of the `tosca.relationships.ConnectsTo` Relationship Template  
3931 are interpreted as the effective set of ports which must be allowed in the network communication.

3932

3933 The meaning of Source and Target port(s) corresponds to the direction of the respective  
3934 `tosca.relationships.ConnectsTo`.

## 3935 **8.4 Network provisioning**

### 3936 **8.4.1 Declarative network provisioning**

3937 TOSCA orchestrators are responsible for the provisioning of the network connectivity for declarative  
3938 TOSCA Service Templates (Declarative TOSCA Service Templates don't contain explicit plans). This  
3939 means that the TOSCA orchestrator must be able to infer a suitable logical connectivity model from the  
3940 Service Template and then decide how to provision the logical connectivity, referred to as "fulfillment", on  
3941 the available underlying infrastructure. In order to enable fulfillment, sufficient technical details still must  
3942 be specified, such as the required protocols, ports and QOS information. TOSCA connectivity types, such  
3943 as `tosca.capabilities.Endpoint`, provide well defined means to express these details.

### 3944 **8.4.2 Implicit network fulfillment**

3945 TOSCA Service Templates are by default network agnostic. TOSCA's application centric approach only  
3946 requires that a TOSCA Service Template contain enough information for a TOSCA orchestrator to infer  
3947 suitable network connectivity to meet the needs of the application components. Thus Service Template  
3948 designers are not required to be aware of or provide specific requirements for underlying networks. This  
3949 approach yields the most portable Service Templates, allowing them to be deployed into any  
3950 infrastructure which can provide the necessary component interconnectivity.

### 3951 **8.4.3 Controlling network fulfillment**

3952 TOSCA provides mechanisms for providing control over network fulfillment.

3953 This mechanism allows the application network designer to express in service template or network  
3954 template how the networks should be provisioned.

3955

3956 For the use cases described below let's assume we have a typical 3-tier application which is consisting of  
3957 FE (frontend), BE (backend) and DB (database) tiers. The simple application topology diagram can be  
3958 shown below:

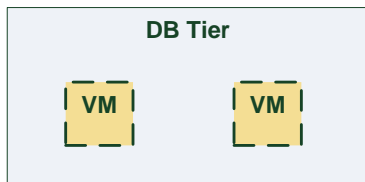
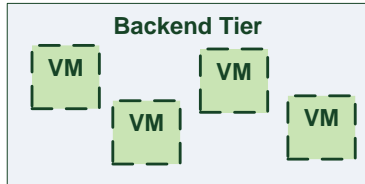
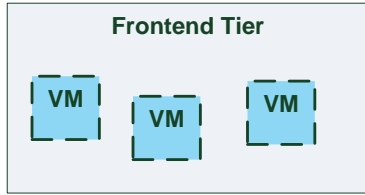

3959

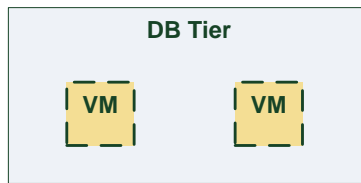
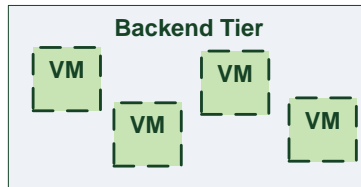
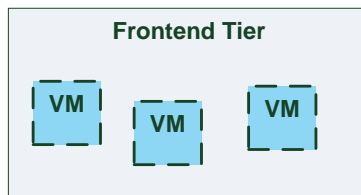

3960

3961

Figure-5: Typical 3-Tier Network

3962 **8.4.3.1 Use case: OAM Network**

3963 When deploying an application in service provider's on-premise cloud, it's very common that one or more  
 3964 of the application's services should be accessible from an ad-hoc OAM (Operations, Administration and  
 3965 Management) network which exists in the service provider backbone.

3966

3967 As an application network designer, I'd like to express in my TOSCA network template (which  
 3968 corresponds to my TOSCA service template) the network CIDR block, start ip, end ip and segmentation  
 3969 ID (e.g. VLAN id).

3970 The diagram below depicts a typical 3-tiers application with specific networking requirements for its FE  
 3971 tier server cluster:

3972

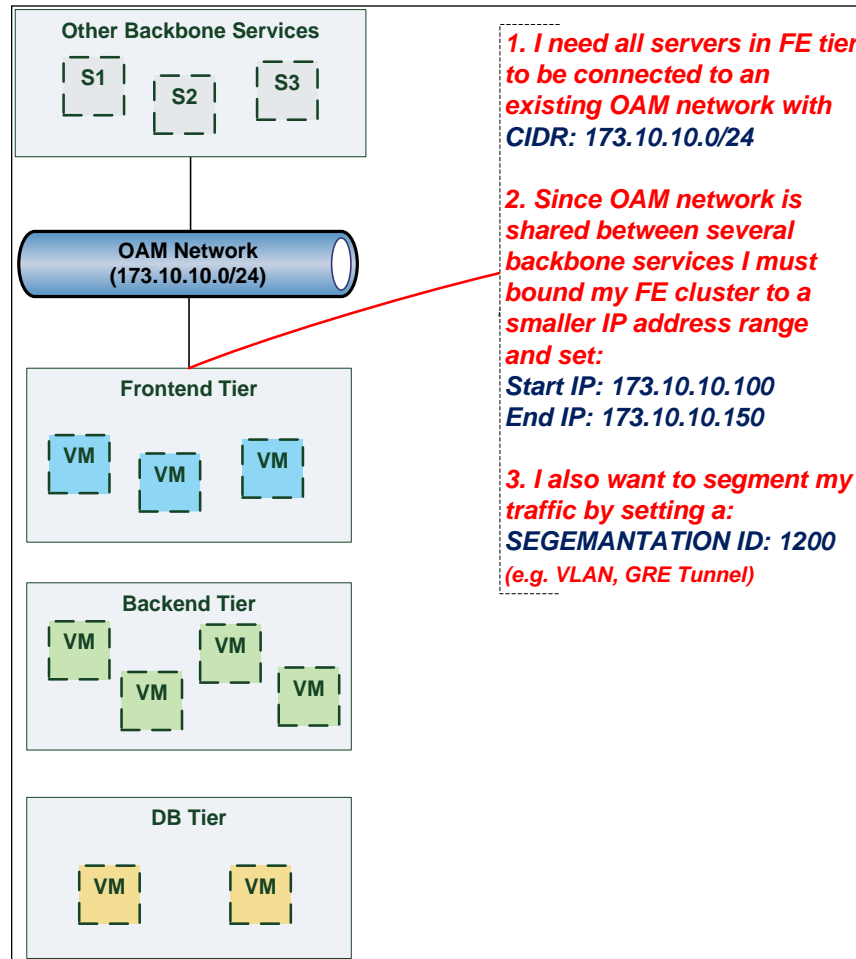

3973

### 3974 8.4.3.2 Use case: Data Traffic network

3975 The diagram below defines a set of networking requirements for the backend and DB tiers of the 3-tier  
3976 app mentioned above.

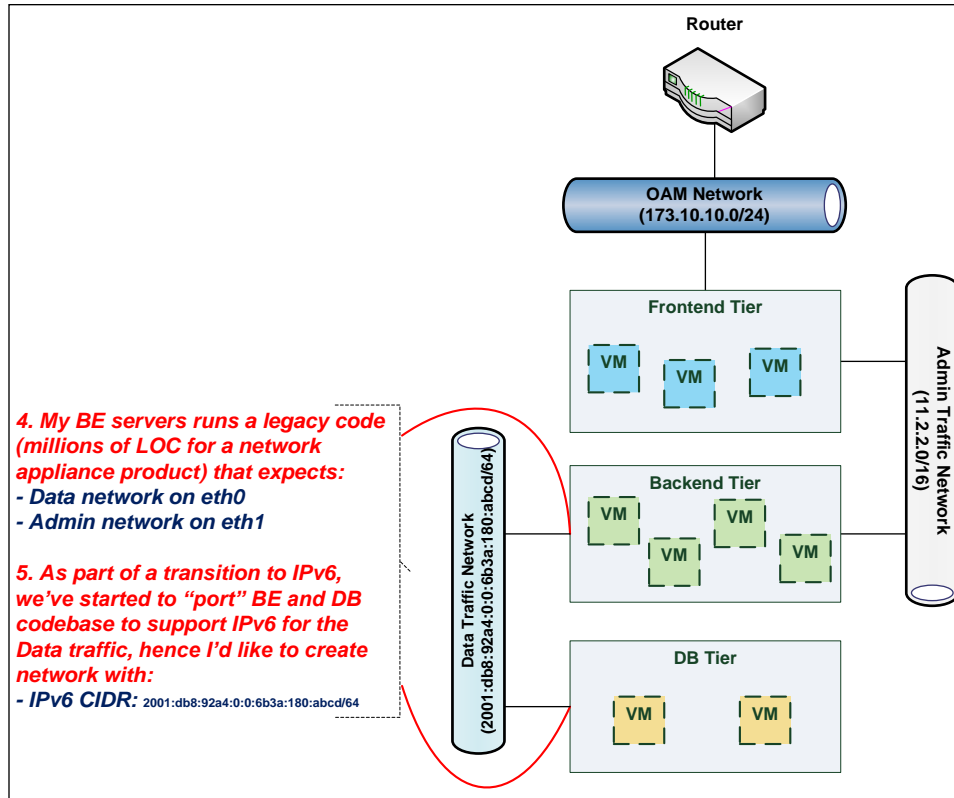

3977

### 3978 8.4.3.3 Use case: Bring my own DHCP

3979 The same 3-tier app requires for its admin traffic network to manage the IP allocation by its own DHCP  
 3980 which runs autonomously as part of application domain.

3981

3982 For this purpose, the app network designer would like to express in TOSCA that the underlying  
 3983 provisioned network will be set with DHCP\_ENABLED=false. See this illustrated in the figure below:

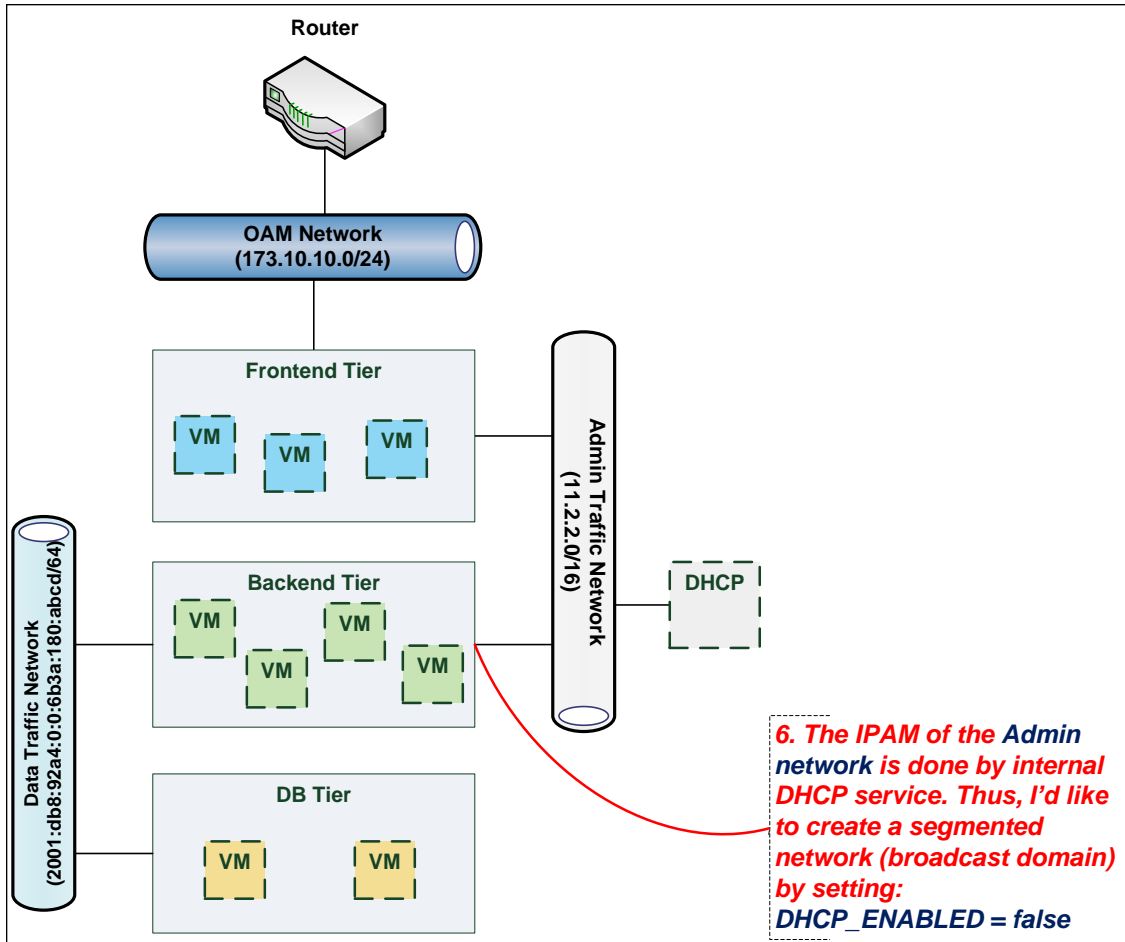

3984

## 3985 8.5 Network Types

### 3986 8.5.1 tosca.nodes.network.Network

3987 The TOSCA Network node represents a simple, logical network service.

<b>Shorthand Name</b>	Network
<b>Type Qualified Name</b>	tosca:Network
<b>Type URI</b>	tosca.nodes.network.Network

#### 3988 8.5.1.1 Properties

Name	Required	Type	Constraints	Description
ip_version	no	integer	valid_values: [4, 6] default: 4	The IP version of the requested network
cidr	no	string	None	The cidr block of the requested network
start_ip	no	string	None	The IP address to be used as the 1 <sup>st</sup> one in a pool of addresses derived from the cidr block full IP range

Name	Required	Type	Constraints	Description
end_ip	no	string	None	The IP address to be used as the last one in a pool of addresses derived from the cidr block full IP range
gateway_ip	no	string	None	The gateway IP address.
network_name	no	string	None	An Identifier that represents an existing Network instance in the underlying cloud infrastructure – OR – be used as the name of the new created network. <ul style="list-style-type: none"> <li>• If <b>network_name</b> is provided along with <b>network_id</b> they will be used to uniquely identify an existing network and not creating a new one, means all other possible properties are not allowed.</li> <li>• <b>network_name</b> should be more convenient for using. But in case that network name uniqueness is not guaranteed then one should provide a <b>network_id</b> as well.</li> </ul>
network_id	no	string	None	An Identifier that represents an existing Network instance in the underlying cloud infrastructure. This property is mutually exclusive with all other properties except network_name. <ul style="list-style-type: none"> <li>• Appearance of <b>network_id</b> in network template instructs the Tosca container to use an existing network instead of creating a new one.</li> <li>• <b>network_name</b> should be more convenient for using. But in case that network name uniqueness is not guaranteed then one should add a <b>network_id</b> as well.</li> <li>• <b>network_name</b> and <b>network_id</b> can be still used together to achieve both uniqueness and convenient.</li> </ul>
segmentation_id	no	string	None	A segmentation identifier in the underlying cloud infrastructure (e.g., VLAN id, GRE tunnel id). If the <b>segmentation_id</b> is specified, the <b>network_type</b> or <b>physical_network</b> properties should be provided as well.
network_type	no	string	None	Optionally, specifies the nature of the physical network in the underlying cloud infrastructure. Examples are flat, vlan, gre or vxlan. For flat and vlan types, <b>physical_network</b> should be provided too.
physical_network	no	string	None	Optionally, identifies the physical network on top of which the network is implemented, e.g. physnet1. This property is required if <b>network_type</b> is flat or vlan.
dhcp_enabled	no	boolean	default: true	Indicates the TOSCA container to create a virtual network instance with or without a DHCP service.

### 3989 8.5.1.2 Attributes

Name	Required	Type	Constraints	Description
segmentation_id	no	string	None	The actual <i>segmentation_id</i> that is been assigned to the network by the underlying cloud infrastructure.



```
tosca.nodes.network.Network:
  derived_from: tosca.nodes.Root
  properties:
    ip_version:
      type: integer
      required: false
      default: 4
      constraints:
        - valid_values: [ 4, 6 ]
    cidr:
      type: string
      required: false
    start_ip:
      type: string
      required: false
    end_ip:
      type: string
      required: false
    gateway_ip:
      type: string
      required: false
    network_name:
      type: string
      required: false
    network_id:
      type: string
      required: false
    segmentation_id:
      type: string
      required: false
    network_type:
      type: string
      required: false
    physical_network:
      type: string
      required: false
  capabilities:
    link:
      type: tosca.capabilities.network.Linkable
```

3991 **8.5.2 tosca.nodes.network.Port**

3992 The TOSCA **Port** node represents a logical entity that associates between Compute and Network normative types.

3994 The Port node type effectively represents a single virtual NIC on the Compute node instance.

<b>Shorthand Name</b>	Port
<b>Type Qualified Name</b>	tosca:Port
<b>Type URI</b>	tosca.nodes.network.Port

3995 **8.5.2.1 Properties**

Name	Required	Type	Constraints	Description
ip_address	no	string	None	Allow the user to set a fixed IP address.  Note that this address is a request to the provider which they will attempt to fulfill but may not be able to dependent on the network the port is associated with.
order	no	integer	greater_or_equal: 0 default: 0	The order of the NIC on the compute instance (e.g. eth2).  <b>Note:</b> when binding more than one port to a single compute (aka multi vNICs) and ordering is desired, it is <i>*mandatory*</i> that all ports will be set with an order value and. The <i>order</i> values must represent a positive, arithmetic progression that starts with 0 (e.g. 0, 1, 2, ..., n).
is_default	no	boolean	default: false	Set <b>is_default</b> =true to apply a default gateway route on the running compute instance to the associated network gateway.  Only one port that is associated to single compute node can set as default=true.
ip_range_start	no	string	None	Defines the starting IP of a range to be allocated for the compute instances that are associated by this Port. Without setting this property the IP allocation is done from the entire CIDR block of the network.
ip_range_end	no	string	None	Defines the ending IP of a range to be allocated for the compute instances that are associated by this Port. Without setting this property the IP allocation is done from the entire CIDR block of the network.

3996 **8.5.2.2 Attributes**

Name	Required	Type	Constraints	Description
ip_address	no	string	None	The IP address would be assigned to the associated compute instance.

3997 **8.5.2.3 Definition**

```
tosca.nodes.network.Port:
  derived_from: tosca.nodes.Root
  properties:
    ip_address:
      type: string
      required: false
    order:
      type: integer
      required: true
      default: 0
      constraints:
        - greater_or_equal: 0
    is_default:
      type: boolean
      required: false
      default: false
    ip_range_start:
      type: string
      required: false
    ip_range_end:
      type: string
      required: false
  requirements:
    - link:
      capability: tosca.capabilities.network.Linkable
      relationship: tosca.relationships.network.LinkTo
    - binding:
      capability: tosca.capabilities.network.Bindable
      relationship: tosca.relationships.network.BindsTo
```

3998 **8.5.3 tosca.capabilities.network.Linkable**

3999 A node type that includes the Linkable capability indicates that it can be pointed to by a  
4000 [tosca.relationships.network.LinkTo](#) relationship type.

<b>Shorthand Name</b>	Linkable
<b>Type Qualified Name</b>	tosca::Linkable
<b>Type URI</b>	tosca.capabilities.network.Linkable

4001 **8.5.3.1 Properties**

Name	Required	Type	Constraints	Description
N/A	N/A	N/A	N/A	N/A

4002 **8.5.3.2 Definition**

```
tosca.capabilities.network.Linkable:
  derived_from: tosca.capabilities.Node
```

4003 **8.5.4 tosca.relationships.network.Linksto**

4004 This relationship type represents an association relationship between Port and Network node types.

<b>Shorthand Name</b>	Linksto
<b>Type Qualified Name</b>	tosca:Linksto
<b>Type URI</b>	tosca.relationships.network.Linksto

4005 **8.5.4.1 Definition**

```
tosca.relationships.network.Linksto:
  derived_from: tosca.relationships.DependsOn
  valid_target_types: [ tosca.capabilities.network.Linkable ]
```

4006 **8.5.5 tosca.relationships.network.BindsTo**

4007 This type represents a network association relationship between Port and Compute node types.

<b>Shorthand Name</b>	network.BindsTo
<b>Type Qualified Name</b>	tosca:BindsTo
<b>Type URI</b>	tosca.relationships.network.BindsTo

4008 **8.5.5.1 Definition**

```
tosca.relationships.network.BindsTo:
  derived_from: tosca.relationships.DependsOn
  valid_target_types: [ tosca.capabilities.network.Bindable ]
```

## 4009 8.6 Network modeling approaches

### 4010 8.6.1 Option 1: Specifying a network outside the application's Service 4011 Template

4012 This approach allows someone who understands the application's networking requirements, mapping the  
4013 details of the underlying network to the appropriate node templates in the application.

4014  
4015 The motivation for this approach is providing the application network designer a fine-grained control on  
4016 how networks are provisioned and stitched to its application by the TOSCA orchestrator and underlying  
4017 cloud infrastructure while still preserving the portability of his service template. Preserving the portability  
4018 means here not doing any modification in service template but just "plug-in" the desired network  
4019 modeling. The network modeling can reside in the same service template file but the best practice should  
4020 be placing it in a separated self-contained network template file.

4021  
4022 This "pluggable" network template approach introduces a new normative node type called Port, capability  
4023 called *tosca.capabilities.network.Linkable* and relationship type called  
4024 *tosca.relationships.network.LinksTo*.

4025 The idea of the Port is to elegantly associate the desired compute nodes with the desired network nodes  
4026 while not "touching" the compute itself.

4027  
4028 The following diagram series demonstrate the plug-ability strength of this approach.

4029 Let's assume an application designer has modeled a service template as shown in Figure 1 that  
4030 describes the application topology nodes (compute, storage, software components, etc.) with their  
4031 relationships. The designer ideally wants to preserve this service template and use it in any cloud  
4032 provider environment without any change.

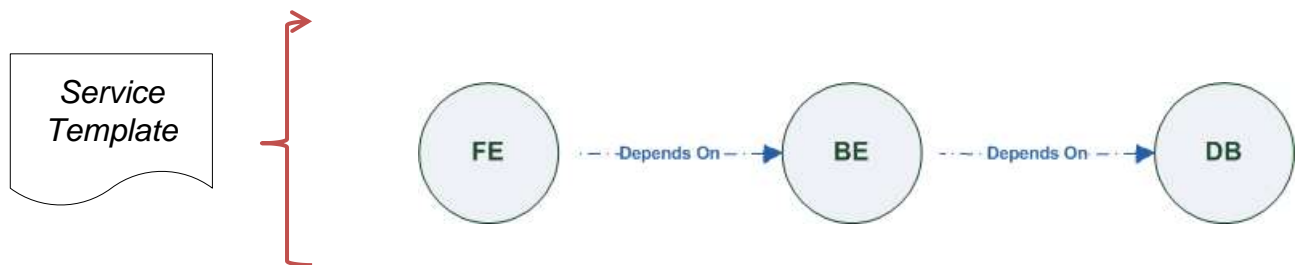

4033  
4034 *Figure-6: Generic Service Template*

4035 When the application designer comes to consider its application networking requirement they typically call  
4036 the network architect/designer from their company (who has the correct expertise).

4037 The network designer, after understanding the application connectivity requirements and optionally the  
4038 target cloud provider environment, is able to model the network template and plug it to the service  
4039 template as shown in Figure 2:

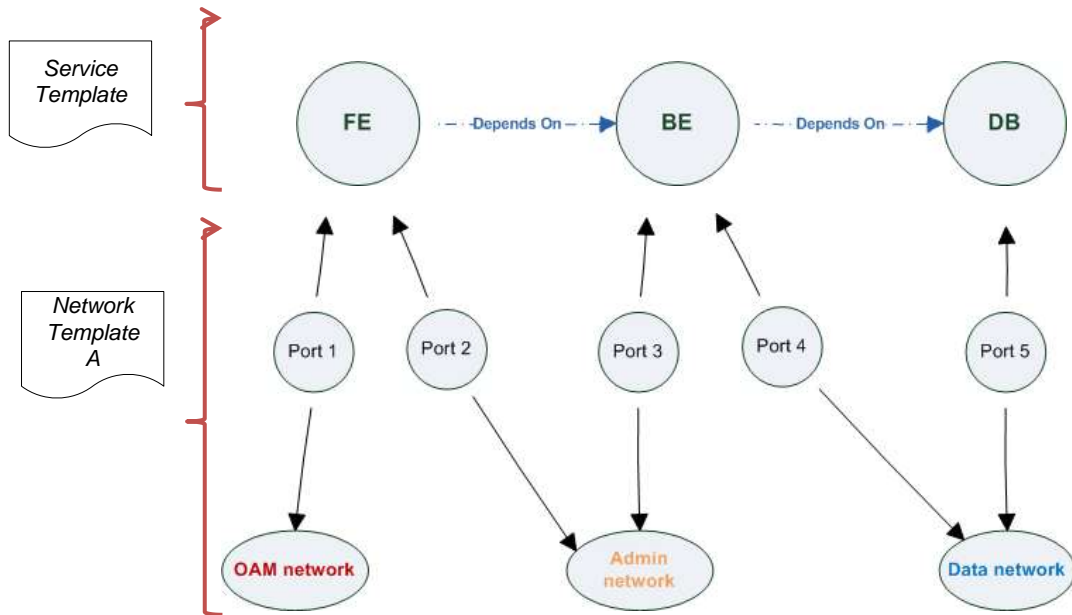

4040

4041

Figure-7: Service template with network template A

4042 When there's a new target cloud environment to run the application on, the network designer is simply  
 4043 creates a new network template B that corresponds to the new environmental conditions and provide it to  
 4044 the application designer which packs it into the application CSAR.

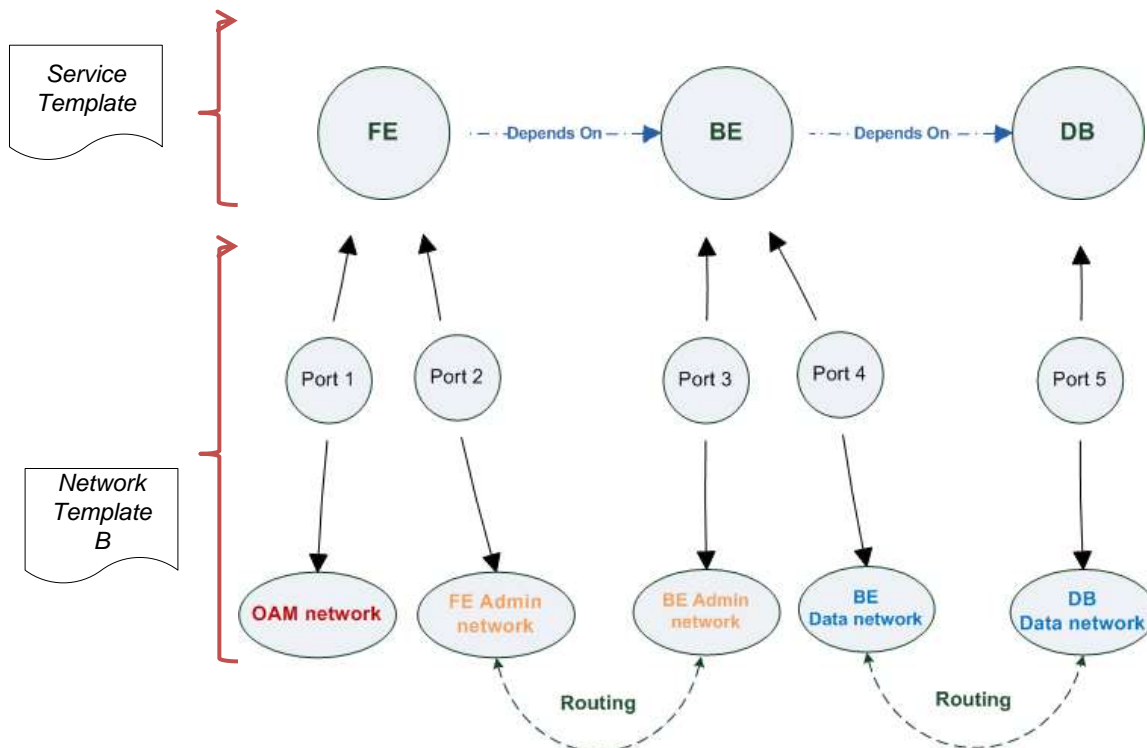

4045

4046

Figure-8: Service template with network template B

4047 The node templates for these three networks would be defined as follows:

```
node_templates:
  frontend:
```

```

type: toasca.nodes.Compute
properties: # omitted for brevity

backend:
  type: toasca.nodes.Compute
  properties: # omitted for brevity

database:
  type: toasca.nodes.Compute
  properties: # omitted for brevity

oam_network:
  type: toasca.nodes.network.Network
  properties: # omitted for brevity

admin_network:
  type: toasca.nodes.network.Network
  properties: # omitted for brevity

data_network:
  type: toasca.nodes.network.Network
  properties: # omitted for brevity

# ports definition
fe_oam_net_port:
  type: toasca.nodes.network.Port
  properties:
    is_default: true
    ip_range_start: { get_input: fe_oam_net_ip_range_start }
    ip_range_end: { get_input: fe_oam_net_ip_range_end }
  requirements:
    - link: oam_network
    - binding: frontend

fe_admin_net_port:
  type: toasca.nodes.network.Port
  requirements:
    - link: admin_network
    - binding: frontend

be_admin_net_port:

```

```

type: toska.nodes.network.Port
properties:
  order: 0
requirements:
  - link: admin_network
  - binding: backend

be_data_net_port:
type: toska.nodes.network.Port
properties:
  order: 1
requirements:
  - link: data_network
  - binding: backend

db_data_net_port:
type: toska.nodes.network.Port
requirements:
  - link: data_network
  - binding: database

```

4048 **8.6.2 Option 2: Specifying network requirements within the application's**  
4049 **Service Template**

4050 This approach allows the Service Template designer to map an endpoint to a logical network.

4051 The use case shown below examines a way to express in the TOSCA YAML service template a typical 3-  
4052 tier application with their required networking modeling:

```

node_templates:
  frontend:
    type: toska.nodes.Compute
    properties: # omitted for brevity
    requirements:
      - network_oam: oam_network
      - network_admin: admin_network
  backend:
    type: toska.nodes.Compute
    properties: # omitted for brevity
    requirements:
      - network_admin: admin_network
      - network_data: data_network

```



```
database:
  type: toasca.nodes.Compute
  properties: # omitted for brevity
  requirements:
    - network_data: data_network

oam_network:
  type: toasca.nodes.network.Network
  properties:
    ip_version: { get_input: oam_network_ip_version }
    cidr: { get_input: oam_network_cidr }
    start_ip: { get_input: oam_network_start_ip }
    end_ip: { get_input: oam_network_end_ip }

admin_network:
  type: toasca.nodes.network.Network
  properties:
    ip_version: { get_input: admin_network_ip_version }
    dhcp_enabled: { get_input: admin_network_dhcp_enabled }

data_network:
  type: toasca.nodes.network.Network
  properties:
    ip_version: { get_input: data_network_ip_version }
    cidr: { get_input: data_network_cidr }
```

4053

---

## 4054 9 Non-normative type definitions

4055 This section defines **non-normative** types which are used only in examples and use cases in this  
4056 specification and are included only for completeness for the reader. Implementations of this specification  
4057 are not required to support these types for conformance.

### 4058 9.1 Artifact Types

4059 This section contains are non-normative Artifact Types used in use cases and examples.

#### 4060 9.1.1 `tosca.artifacts.Deployment.Image.Container.Docker`

4061 This artifact represents a Docker “image” (a TOSCA deployment artifact type) which is a binary comprised  
4062 of one or more (a union of read-only and read-write) layers created from snapshots within the underlying  
4063 Docker **Union File System**.

##### 4064 9.1.1.1 Definition

```
tosca.artifacts.Deployment.Image.Container.Docker:  
  derived_from: tosca.artifacts.Deployment.Image  
  description: Docker Container Image
```

#### 4065 9.1.2 `tosca.artifacts.Deployment.Image.VM.ISO`

4066 A Virtual Machine (VM) formatted as an ISO standard disk image.

##### 4067 9.1.2.1 Definition

```
tosca.artifacts.Deployment.Image.VM.ISO:  
  derived_from: tosca.artifacts.Deployment.Image.VM  
  description: Virtual Machine (VM) image in ISO disk format  
  mime_type: application/octet-stream  
  file_ext: [ iso ]
```

#### 4068 9.1.3 `tosca.artifacts.Deployment.Image.VM.QCOW2`

4069 A Virtual Machine (VM) formatted as a QEMU emulator version 2 standard disk image.

##### 4070 9.1.3.1 Definition

```
tosca.artifacts.Deployment.Image.VM.QCOW2:  
  derived_from: tosca.artifacts.Deployment.Image.VM  
  description: Virtual Machine (VM) image in QCOW v2 standard disk format  
  mime_type: application/octet-stream  
  file_ext: [ qcow2 ]
```

## 4071 9.2 Capability Types

4072 This section contains are non-normative Capability Types used in use cases and examples.

4073 **9.2.1 tosca.capabilities.Container.Docker**

4074 The type indicates capabilities of a Docker runtime environment (client).

<b>Shorthand Name</b>	Container.Docker
<b>Type Qualified Name</b>	tosca:Container.Docker
<b>Type URI</b>	tosca.capabilities.Container.Docker

4075 **9.2.1.1 Properties**

Name	Required	Type	Constraints	Description
version	no	<a href="#">version[]</a>	None	The Docker version capability (i.e., the versions supported by the capability).
publish_all	no	<a href="#">boolean</a>	default: false	Indicates that all ports (ranges) listed in the <i>dockerfile</i> using the <b>EXPOSE</b> keyword be published.
publish_ports	no	list of <a href="#">PortSpec</a>	None	List of ports mappings from source (Docker container) to target (host) ports to publish.
expose_ports	no	list of <a href="#">PortSpec</a>	None	List of ports mappings from source (Docker container) to expose to other Docker containers (not accessible outside host).
volumes	no	list of <a href="#">string</a>	None	The <i>dockerfile</i> VOLUME command which is used to enable access from the Docker container to a directory on the host machine.
host_id	no	<a href="#">string</a>	None	The optional identifier of an existing host resource that should be used to run this container on.
volume_id	no	<a href="#">string</a>	None	The optional identifier of an existing storage volume (resource) that should be used to create the container's mount point(s) on.

4076 **9.2.1.2 Definition**

```
tosca.capabilities.Container.Docker:
  derived_from: tosca.capabilities.Container
  properties:
    version:
      type: list
      required: false
      entry_schema: version
    publish_all:
      type: boolean
      default: false
      required: false
    publish_ports:
      type: list
      entry_schema: PortSpec
```

```

    required: false
  expose_ports:
    type: list
    entry_schema: PortSpec
    required: false
  volumes:
    type: list
    entry_schema: string
    required: false

```

### 4077 9.2.1.3 Notes

- 4078 • When the **expose\_ports** property is used, only the **source** and **source\_range** properties of  
4079 **PortSpec** would be valid for supplying port numbers or ranges, the **target** and **target\_range**  
4080 properties would be ignored.

## 4081 9.3 Node Types

4082 This section contains non-normative node types referenced in use cases and examples. All additional  
4083 Attributes, Properties, Requirements and Capabilities shown in their definitions (and are not inherited  
4084 from ancestor normative types) are also considered to be non-normative.

### 4085 9.3.1 **tosca.nodes.Database.MySQL**

#### 4086 9.3.1.1 Properties

Name	Required	Type	Constraints	Description
N/A	N/A	N/A	N/A	N/A

#### 4087 9.3.1.2 Definition

```

tosca.nodes.Database.MySQL:
  derived_from: tosca.nodes.Database
  requirements:
    - host:
      node: tosca.nodes.DBMS.MySQL

```

### 4088 9.3.2 **tosca.nodes.DBMS.MySQL**

#### 4089 9.3.2.1 Properties

Name	Required	Type	Constraints	Description
N/A	N/A	N/A	N/A	N/A

#### 4090 9.3.2.2 Definition

```

tosca.nodes.DBMS.MySQL:

```

```

derived_from: tosca.nodes.DBMS
properties:
  port:
    description: reflect the default MySQL server port
    default: 3306
  root_password:
    # MySQL requires a root_password for configuration
    # Override parent DBMS definition to make this property required
    required: true
capabilities:
  # Further constrain the 'host' capability to only allow MySQL databases
  host:
    valid_source_types: [ tosca.nodes.Database.MySQL ]

```

### 4091 [9.3.3 tosca.nodes.WebServer.Apache](#)

#### 4092 [9.3.3.1 Properties](#)

Name	Required	Type	Constraints	Description
N/A	N/A	N/A	N/A	N/A

#### 4093 [9.3.3.2 Definition](#)

```

tosca.nodes.WebServer.Apache:
  derived_from: tosca.nodes.WebServer

```

### 4094 [9.3.4 tosca.nodes.WebApplication.WordPress](#)

4095 This section defines a non-normative Node type for the WordPress [[WordPress](#)] application.

#### 4096 [9.3.4.1 Properties](#)

Name	Required	Type	Constraints	Description
N/A	N/A	N/A	N/A	N/A

#### 4097 [9.3.4.2 Definition](#)

```

tosca.nodes.WebApplication.WordPress:
  derived_from: tosca.nodes.WebApplication
  properties:
    admin_user:
      type: string
    admin_password:
      type: string
    db_host:

```

```

type: string
requirements:
  - database_endpoint:
      capability: tosca.capabilities.Endpoint.Database
      node: tosca.nodes.Database
      relationship: tosca.relationships.ConnectsTo

```

### 4098 9.3.5 tosca.nodes.WebServer.Nodejs

4099 This non-normative node type represents a Node.js [NodeJS] web application server.

#### 4100 9.3.5.1 Properties

Name	Required	Type	Constraints	Description
N/A	N/A	N/A	N/A	N/A

#### 4101 9.3.5.2 Definition

```

tosca.nodes.WebServer.Nodejs:
  derived_from: tosca.nodes.WebServer
  properties:
    # Property to supply the desired implementation in the Github repository
    github_url:
      required: no
      type: string
      description: location of the application on the github.
      default: https://github.com/mmm/testnode.git
  interfaces:
    Standard:
      inputs:
        github_url:
          type: string

```

### 4102 9.3.6 tosca.nodes.Container.Application.Docker

#### 4103 9.3.6.1 Properties

Name	Required	Type	Constraints	Description
N/A	N/A	N/A	N/A	N/A

#### 4104 9.3.6.2 Definition

```

tosca.nodes.Container.Application.Docker:
  derived_from: tosca.nodes.ContainerApplication
  requirements:

```

```
- host:  
  capability: toska.capabilities.Container.Docker
```

---

## 4105 10 Component Modeling Use Cases

4106 This section is **non-normative** and includes use cases that explore how to model components and their  
4107 relationships using TOSCA Simple Profile in YAML.

### 4108 10.1.1 Use Case: Exploring the HostedOn relationship using 4109 WebApplication and WebServer

4110 This use case examines the ways TOSCA YAML can be used to express a simple hosting relationship  
4111 (i.e., **HostedOn**) using the normative TOSCA **WebServer** and **WebApplication** node types defined in this  
4112 specification.

#### 4113 10.1.1.1 WebServer declares its “host” capability

4114 For convenience, relevant parts of the normative TOSCA Node Type for **WebServer** are shown below:

```
tosca.nodes.WebServer
  derived_from: SoftwareComponent
  capabilities:
    ...
  host:
    type: tosca.capabilities.Container
    valid_source_types: [ tosca.nodes.WebApplication ]
```

4115 As can be seen, the **WebServer** Node Type declares its capability to “contain” (i.e., host) other nodes  
4116 using the symbolic name “**host**” and providing the Capability Type **tosca.capabilities.Container**. It  
4117 should be noted that the symbolic name of “**host**” is not a reserved word, but one assigned by the type  
4118 designer that implies at or betokens the associated capability. The **Container** capability definition also  
4119 includes a required list of valid Node Types that can be contained by this, the **WebServer**, Node Type.  
4120 This list is declared using the keyname of **valid\_source\_types** and in this case it includes only allowed  
4121 type **WebApplication**.

#### 4122 10.1.1.2 WebApplication declares its “host” requirement

4123 The **WebApplication** node type needs to be able to describe the type of capability a target node would  
4124 have to provide in order to “host” it. The normative TOSCA capability type **tosca.capabilities.Container** is  
4125 used to describe all normative TOSCA hosting (i.e., container-containee pattern) relationships. As can be  
4126 seen below, the **WebApplication** accomplishes this by declaring a requirement with the symbolic name  
4127 “**host**” with the **capability** keyname set to **tosca.capabilities.Container**.

4128 Again, for convenience, the relevant parts of the normative **WebApplication** Node Type are shown below:

```
tosca.nodes.WebApplication:
  derived_from: tosca.nodes.Root
  requirements:
    - host:
      capability: tosca.capabilities.Container
      node: tosca.nodes.WebServer
      relationship: tosca.relationships.HostedOn
```



4129 **10.1.1.2.1 Notes**

- 4130 • The symbolic name “host” is not a keyword and was selected for consistent use in TOSCA  
4131 normative node types to give the reader an indication of the type of requirement being  
4132 referenced. A valid HostedOn relationship could still be established between WebApplicaton and  
4133 WebServer in a TOSCA Service Template regardless of the symbolic name assigned to either the  
4134 requirement or capability declaration.

4135 **10.1.2 Use Case: Establishing a ConnectsTo relationship to WebServer**

4136 This use case examines the ways TOSCA YAML can be used to express a simple connection  
4137 relationship (i.e., [ConnectsTo](#)) between some service derived from the [SoftwareComponent](#) Node Type,  
4138 to the normative [WebServer](#) node type defined in this specification.

4139 The service template that would establish a [ConnectsTo](#) relationship as follows:

```
node_types:
  MyServiceType:
    derived_from: SoftwareComponent
    requirements:
      # This type of service requires a connection to a WebServer's data_endpoint
      - connection1:
          node: WebServer
          relationship: ConnectsTo
          capability: Endpoint

topology_template:
  node_templates:
    my_web_service:
      type: MyServiceType
      ...
    requirements:
      - connection1:
          node: my_web_server

  my_web_server:
    # Note, the normative WebServer node type declares the “data_endpoint”
    # capability of type tosca.capabilities.Endpoint.
    type: WebServer
```

4140 Since the normative **WebServer** Node Type only declares one capability of type  
4141 **tosca.capabilities.Endpoint** (or **Endpoint**, its shortname alias in TOSCA) using the symbolic name  
4142 **data\_endpoint**, the **my\_web\_service** node template does not need to declare that symbolic name on its  
4143 requirement declaration. If however, the **my\_web\_server** node was based upon some other node type  
4144 that declared more than one capability of type **Endpoint**, then the **capability** keyname could be used  
4145 to supply the desired symbolic name if necessary.

4146 **10.1.2.1 Best practice**

4147 It should be noted that the best practice for designing Node Types in TOSCA should not export two  
4148 capabilities of the same type if they truly offer different functionality (i.e., different capabilities) which  
4149 should be distinguished using different Capability Type definitions.

4150 **10.1.3 Use Case: Attaching (local) BlockStorage to a Compute node**

4151 This use case examines the ways TOSCA YAML can be used to express a simple AttachesTo  
4152 relationship between a Compute node and a locally attached BlockStorage node.

4153 The service template that would establish an [AttachesTo](#) relationship follows:

```
node_templates:
  my_server:
    type: Compute
    ...
    requirements:
      # contextually this can only be a relationship type
      - local_storage:
          # capability is provided by Compute Node Type
          node: my_block_storage
          relationship:
            type: AttachesTo
            properties:
              location: /path1/path2
          # This maps the local requirement name 'local_storage' to the
          # target node's capability name 'attachment'

  my_block_storage:
    type: BlockStorage
    properties:
      size: 10 GB
```

4154 **10.1.4 Use Case: Reusing a BlockStorage Relationship using Relationship**  
4155 **Type or Relationship Template**

4156 This builds upon the previous use case (10.1.3) to examine how a template author could attach multiple  
4157 Compute nodes (templates) to the same BlockStorage node (template), but with slightly different property  
4158 values for the AttachesTo relationship.

4159 Specifically, several notation options are shown (in this use case) that achieve the same desired result.  
4160

4161 **10.1.4.1 Simple Profile Rationale**

4162 Referencing an explicitly declared Relationship Template is a convenience of the Simple Profile that  
4163 allows template authors an entity to set, constrain or override the properties and operations as defined in  
4164 its declared (Relationship) Type much as allowed now for Node Templates. It is especially useful when a  
4165 complex Relationship Type (with many configurable properties or operations) has several logical

4166 occurrences in the same Service (Topology) Template; allowing the author to avoid configuring these  
4167 same properties and operations in multiple Node Templates.

#### 4168 **10.1.4.2 Notation Style #1: Augment AttachesTo Relationship Type directly in** 4169 **each Node Template**

4170 This notation extends the methodology used for establishing a HostedOn relationship, but allowing  
4171 template author to supply (dynamic) configuration and/or override of properties and operations.

4172

4173 **Note:** This option will remain valid for Simple Profile regardless of other notation (copy or aliasing) options  
4174 being discussed or adopted for future versions.

4175

```
node_templates:

  my_block_storage:
    type: BlockStorage
    properties:
      size: 10

  my_web_app_tier_1:
    type: Compute
    requirements:
      - local_storage:
          node: my_block_storage
          relationship: MyAttachesTo
          # use default property settings in the Relationship Type definition

  my_web_app_tier_2:
    type: Compute
    requirements:
      - local_storage:
          node: my_block_storage
          relationship:
            type: MyAttachesTo
            # Override default property setting for just the 'location' property
          properties:
            location: /some_other_data_location

relationship_types:

  MyAttachesTo:
    derived_from: AttachesTo
    properties:
```

```
location: /default_location
interfaces:
  Configure:
    post_configure_target:
      implementation: default_script.sh
```

4176

4177 **10.1.4.3 Notation Style #2: Use the ‘template’ keyword on the Node Templates to**  
4178 **specify which named Relationship Template to use**

4179 This option shows how to explicitly declare different named Relationship Templates within the Service  
4180 Template as part of a **relationship\_templates** section (which have different property values) and can  
4181 be referenced by different Compute typed Node Templates.

4182

```
node_templates:

  my_block_storage:
    type: BlockStorage
    properties:
      size: 10

  my_web_app_tier_1:
    derived_from: Compute
    requirements:
      - local_storage:
          node: my_block_storage
          relationship: storage_attachesto_1

  my_web_app_tier_2:
    derived_from: Compute
    requirements:
      - local_storage:
          node: my_block_storage
          relationship: storage_attachesto_2

relationship_templates:
  storage_attachesto_1:
    type: MyAttachesTo
    properties:
      location: /my_data_location

  storage_attachesto_2:
```

```

type: MyAttachesTo
properties:
  location: /some_other_data_location

relationship_types:

MyAttachesTo:
  derived_from: AttachesTo
  interfaces:
    some_interface_name:
      some_operation:
        implementation: default_script.sh

```

4183

4184 **10.1.4.4 Notation Style #3: Using the “copy” keyname to define a similar**  
4185 **Relationship Template**

4186 How does TOSCA make it easier to create a new relationship template that is mostly the same as one  
4187 that exists without manually copying all the same information? TOSCA provides the **copy** keyname as a  
4188 convenient way to copy an existing template definition into a new template definition as a starting point or  
4189 basis for describing a new definition and avoid manual copy. The end results are cleaner TOSCA Service  
4190 Templates that allows the description of only the changes (or deltas) between similar templates.

4191 The example below shows that the Relationship Template named **storage\_attachesto\_1** provides  
4192 some overrides (conceptually a large set of overrides) on its Type which the Relationship Template  
4193 named **storage\_attachesto\_2** wants to “**copy**” before perhaps providing a smaller number of overrides.

```

node_templates:

my_block_storage:
  type: BlockStorage
  properties:
    size: 10

my_web_app_tier_1:
  derived_from: Compute
  requirements:
    - attachment:
      node: my_block_storage
      relationship: storage_attachesto_1

my_web_app_tier_2:
  derived_from: Compute
  requirements:
    - attachment:

```

```

    node: my_block_storage
    relationship: storage_attachesto_2

relationship_templates:
  storage_attachesto_1:
    type: MyAttachesTo
    properties:
      location: /my_data_location
    interfaces:
      some_interface_name:
        some_operation_name_1: my_script_1.sh
        some_operation_name_2: my_script_2.sh
        some_operation_name_3: my_script_3.sh

  storage_attachesto_2:
    # Copy the contents of the "storage_attachesto_1" template into this new one
    copy: storage_attachesto_1
    # Then change just the value of the location property
    properties:
      location: /some_other_data_location

relationship_types:

MyAttachesTo:
  derived_from: AttachesTo
  interfaces:
    some_interface_name:
      some_operation:
        implementation: default_script.sh

```

4194

# 11 Application Modeling Use Cases

4195 This section is **non-normative** and includes use cases that show how to model Infrastructure-as-a-  
 4196 Service (IaaS), Platform-as-a-Service (PaaS) and complete application uses cases using TOSCA Simple  
 4197 Profile in YAML.

## 11.1 Use cases

4199 Many of the use cases listed below can be found under the following link:

4200 <https://github.com/openstack/heat-translator/tree/master/translator/tests/data>

### 11.1.1 Overview

Name	Description
<b>Compute</b> : Create a single Compute instance with a host Operating System	Introduces a TOSCA <b>Compute</b> node type which is used to stand up a single compute instance with a host Operating System Virtual Machine (VM) image selected by the platform provider using the Compute node's properties.
<b>Software Component 1</b> : Automatic deployment of a Virtual Machine (VM) image artifact	Introduces the <b>SoftwareComponent</b> node type which declares software that is hosted on a <b>Compute</b> instance. In this case, the SoftwareComponent declares a VM image as a deployment artifact which includes its own pre-packaged operating system and software. The TOSCA Orchestrator detects this known deployment artifact type on the <b>SoftwareComponent</b> node template and automatically deploys it to the Compute node.
<b>BlockStorage-1</b> : Attaching Block Storage to a single Compute instance	Demonstrates how to attach a TOSCA <b>BlockStorage</b> node to a <b>Compute</b> node using the normative <b>AttachesTo</b> relationship.
<b>BlockStorage-2</b> : Attaching Block Storage using a custom Relationship Type	Demonstrates how to attach a TOSCA <b>BlockStorage</b> node to a <b>Compute</b> node using a custom RelationshipType that derives from the normative <b>AttachesTo</b> relationship.
<b>BlockStorage-3</b> : Using a Relationship Template of type AttachesTo	Demonstrates how to attach a TOSCA <b>BlockStorage</b> node to a <b>Compute</b> node using a TOSCA Relationship Template that is based upon the normative <b>AttachesTo</b> Relationship Type.
<b>BlockStorage-4</b> : Single Block Storage shared by 2-Tier Application with custom AttachesTo Type and implied relationships	This use case shows 2 <b>Compute</b> instances (2 tiers) with one BlockStorage node, and also uses a custom <b>AttachesTo</b> Relationship that provides a default mount point (i.e., <b>location</b> ) which the 1 <sup>st</sup> tier uses, but the 2 <sup>nd</sup> tier provides a different mount point.
<b>BlockStorage-5</b> : Single Block Storage shared by 2-Tier Application with custom AttachesTo Type and explicit Relationship Templates	This use case is like the previous <b>BlockStorage-4</b> use case, but also creates two relationship templates (one for each tier) each of which provide a different mount point (i.e., <b>location</b> ) which overrides the default location defined in the custom Relationship Type.
<b>BlockStorage-6</b> : Multiple Block Storage attached to different Servers	This use case demonstrates how two different TOSCA <b>BlockStorage</b> nodes can be attached to two different <b>Compute</b> nodes (i.e., servers) each using the normative <b>AttachesTo</b> relationship.
<b>Object Storage 1</b> : Creating an Object Storage service	Introduces the TOSCA <b>ObjectStorage</b> node type and shows how it can be instantiated.
<b>Network-1</b> : Server bound to a new network	Introduces the TOSCA <b>Network</b> and <b>Port</b> nodes used for modeling logical networks using the <b>LinksTo</b> and <b>BindsTo</b> Relationship Types. In this use case, the template is invoked without an existing <b>network_name</b> as an input property so a new network is created using the properties declared in the Network node.

<b>Network-2:</b> Server bound to an existing network	Shows how to use a <b>network_name</b> as an input parameter to the template to allow a server to be associated with (i.e. bound to) an existing <b>Network</b> .
<b>Network-3:</b> Two servers bound to a single network	This use case shows how two servers ( <b>Compute</b> nodes) can be associated with the same <b>Network</b> node using two logical network <b>Ports</b> .
<b>Network-4:</b> Server bound to three networks	This use case shows how three logical networks ( <b>Network</b> nodes), each with its own IP address range, can be associated with the same server ( <b>Compute</b> node).
<b>WebServer-DBMS-1:</b> WordPress [WordPress] + MySQL, single instance	Shows how to host a TOSCA <b>WebServer</b> with a TOSCA <b>WebApplication</b> , <b>DBMS</b> and <b>Database Node Types</b> along with their dependent <b>HostedOn</b> and <b>ConnectsTo</b> relationships.
<b>WebServer-DBMS-2:</b> Nodejs with PayPal Sample App and MongoDB on separate instances	Instantiates a 2-tier application with <b>Nodejs</b> and its (PayPal sample) <b>WebApplication</b> on one tier which connects a MongoDB database (which stores its application data) using a <b>ConnectsTo</b> relationship.
<b>Multi-Tier-1:</b> Elasticsearch, Logstash, Kibana (ELK)	<p>Shows <b>Elasticsearch</b>, <b>Logstash</b> and <b>Kibana</b> (ELK) being used in a typical manner to collect, search and monitor/visualize data from a running application.</p> <p>This use case builds upon the previous <b>Nodejs/MongoDB</b> 2-tier application as the one being monitored. The <b>collectd</b> and <b>rsyslog</b> components are added to both the <b>WebServer</b> and <b>Database</b> tiers which work to collect data for <b>Logstash</b>.</p> <p>In addition to the application tiers, a 3<sup>rd</sup> tier is introduced with <b>Logstash</b> to collect data from the application tiers. Finally a 4<sup>th</sup> tier is added to search the <b>Logstash</b> data with <b>Elasticsearch</b> and visualize it using <b>Kibana</b>.</p> <p><b>Note:</b> This use case also shows the convenience of using a single YAML macro (declared in the <b>dsl_definitions</b> section of the TOSCA Service Template) on multiple <b>Compute</b> nodes.</p>
<b>Container-1:</b> Containers using Docker single Compute instance (Containers only)	<p>Minimalist TOSCA Service Template description of 2 Docker containers linked to each other. Specifically, one container runs <b>wordpress</b> and connects to second <b>mysql</b> database container both on a single server (i.e., Compute instance). The use case also demonstrates how TOSCA declares and references Docker images from the Docker Hub repository.</p> <p><b>Variation 1:</b> Docker <b>Container</b> nodes (only) providing their Docker Requirements allowing platform (orchestrator) to select/provide the underlying Docker implementation (Capability).</p>

## 4202 11.1.2 Compute: Create a single Compute instance with a host Operating System

### 4204 11.1.2.1 Description

4205 This use case demonstrates how the TOSCA Simple Profile specification can be used to stand up a  
4206 single Compute instance with a guest Operating System using a normative TOSCA **Compute** node. The  
4207 TOSCA Compute node is declarative in that the service template describes both the processor and host  
4208 operating system platform characteristics (i.e., properties declared on the capability named “**os**”  
4209 sometimes called a “flavor”) that are desired by the template author. The cloud provider would attempt to  
4210 fulfill these properties (to the best of its abilities) during orchestration.

### 4211 11.1.2.2 Features

4212 This use case introduces the following TOSCA Simple Profile features:

- 4213 • A node template that uses the normative TOSCA **Compute** Node Type along with showing an  
4214 exemplary set of its properties being configured.



- 4215 • Use of the TOSCA Service Template **inputs** section to declare a configurable value the template
- 4216 user may supply at runtime. In this case, the “host” property named “num\_cpus” (of type integer)
- 4217 is declared.
  - 4218 ○ Use of a property constraint to limit the allowed integer values for the “num\_cpus”
  - 4219 property to a specific list supplied in the property declaration.
- 4220 • Use of the TOSCA Service Template **outputs** section to declare a value the template user may
- 4221 request at runtime. In this case, the property named “instance\_ip” is declared
  - 4222 ○ The “instance\_ip” output property is programmatically retrieved from the **Compute**
  - 4223 node’s “public\_address” attribute using the TOSCA Service Template-level
  - 4224 **get\_attribute** function.

4225 **11.1.2.3 Logical Diagram**

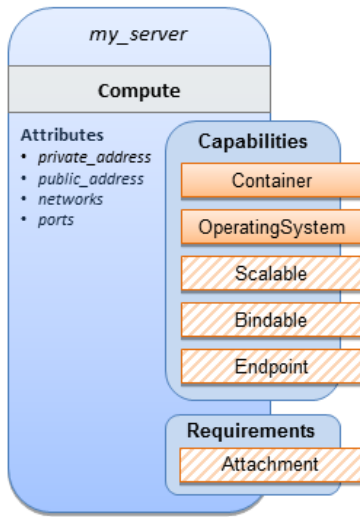

4226

4227 **11.1.2.4 Sample YAML**

```

tosca_definitions_version: tosca_simple_yaml_1_0

description: >
  TOSCA simple profile that just defines a single compute instance and selects a
  (guest) host Operating System from the Compute node’s properties. Note, this
  example does not include default values on inputs properties.

topology_template:
  inputs:
    cpus:
      type: integer
      description: Number of CPUs for the server.
      constraints:
        - valid_values: [ 1, 2, 4, 8 ]

  node_templates:

```

```

my_server:
  type: Compute
  capabilities:
    host:
      properties:
        disk_size: 10 GB
        num_cpus: { get_input: cpus }
        mem_size: 1 GB
    os:
      properties:
        architecture: x86_64
        type: Linux
        distribution: ubuntu
        version: 12.04
  outputs:
    private_ip:
      description: The private IP address of the deployed server instance.
      value: { get_attribute: [my_server, private_address] }

```

#### 4228 11.1.2.5 Notes

- 4229 • This use case uses a versioned, Linux Ubuntu distribution on the Compute node.

### 4230 11.1.3 Software Component 1: Automatic deployment of a Virtual Machine 4231 (VM) image artifact

#### 4232 11.1.3.1 Description

4233 This use case demonstrates how the TOSCA SoftwareComponent node type can be used to declare  
4234 software that is packaged in a standard Virtual Machine (VM) image file format (i.e., in this case QCOW2)  
4235 and is hosted on a TOSCA Compute node (instance). In this variation, the SoftwareComponent declares  
4236 a VM image as a deployment artifact that includes its own pre-packaged operating system and software.  
4237 The TOSCA Orchestrator detects this known deployment artifact type on the SoftwareComponent node  
4238 template and automatically deploys it to the Compute node.

#### 4239 11.1.3.2 Features

4240 This use case introduces the following TOSCA Simple Profile features:

- 4241 • A node template that uses the normative TOSCA **SoftwareComponent** Node Type along with  
4242 showing an exemplary set of its properties being configured.
- 4243 • Use of the TOSCA Service Template **artifacts** section to declare a Virtual Machine (VM) image  
4244 artifact type which is referenced by the **SoftwareComponent** node template.
- 4245 • The VM file format, in this case QCOW2, includes its own guest Operating System (OS) and  
4246 therefore does **not** “require” a TOSCA **OperatingSystem** capability from the TOSCA Compute  
4247 node.

4248 **11.1.3.3 Assumptions**

4249 This use case assumes the following:

- 4250 • That the TOSCA Orchestrator (working with the Cloud provider’s underlying management  
4251 services) is able to instantiate a Compute node that has a hypervisor that supports the Virtual  
4252 Machine (VM) image format, in this case QCOW2, which should be compatible with many  
4253 standard hypervisors such as XEN and KVM.
- 4254 • This is not a “bare metal” use case and assumes the existence of a hypervisor on the machine  
4255 that is allocated to “host” the Compute instance supports (e.g. has drivers, etc.) the VM image  
4256 format in this example.

4257 **11.1.3.4 Logical Diagram**

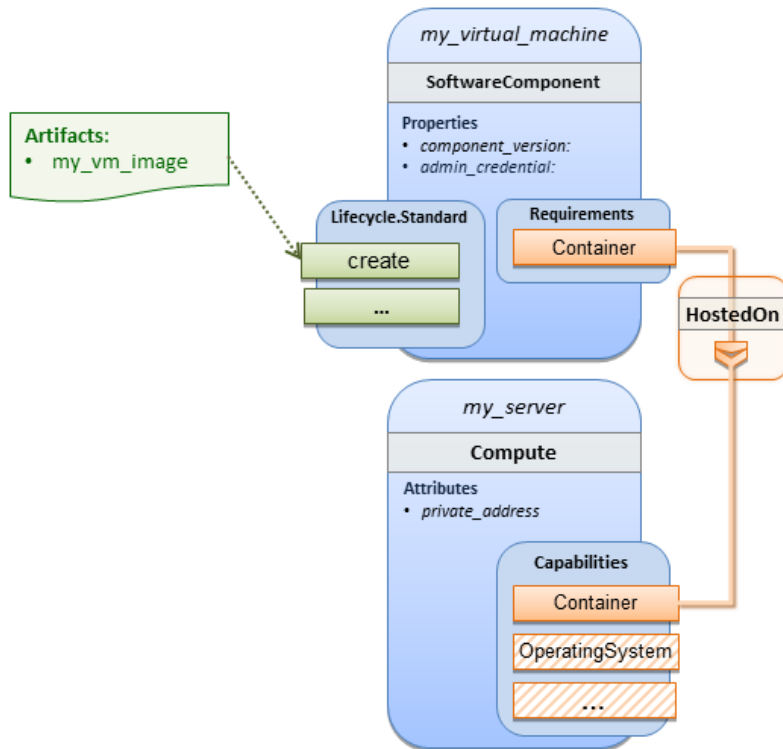

4258

4259 **11.1.3.5 Sample YAML**

```
tosca_definitions_version: tosca_simple_yaml_1_0

description: >
  TOSCA Simple Profile with a SoftwareComponent node with a declared Virtual
  machine (VM) deployment artifact that automatically deploys to its host Compute
  node.

topology_template:

  node_templates:
    my_virtual_machine:
```

```

type: SoftwareComponent
artifacts:
  my_vm_image:
    file: images/fedora-18-x86_64.qcow2
    type: toska.artifacts.Deployment.Image.VM.QCOW2
requirements:
  - host: my_server
# Automatically deploy the VM image referenced on the create operation
interfaces:
  Standard:
    create: my_vm_image

# Compute instance with no Operating System guest host
my_server:
  type: Compute
  capabilities:
    # Note: no guest OperatingSystem requirements as these are in the image.
  host:
    properties:
      disk_size: 10 GB
      num_cpus: { get_input: cpus }
      mem_size: 4 GB

outputs:
  private_ip:
    description: The private IP address of the deployed server instance.
    value: { get_attribute: [my_server, private_address] }

```

### 4260 11.1.3.6 Notes

- 4261 • The use of the **type** keyname on the **artifact** definition (within the **my\_virtual\_machine** node
- 4262 template) to declare the ISO image deployment artifact type (i.e.,
- 4263 **tosca.artifacts.Deployment.Image.VM.ISO**) is redundant since the file extension is “.iso”
- 4264 which associated with this known, declared artifact type.
- 4265 • This use case references a filename on the **my\_vm\_image** artifact, which indicates a Linux,
- 4266 Fedora 18, x86 VM image, only as one possible example.

## 4267 11.1.4 Block Storage 1: Using the normative AttachesTo Relationship Type

### 4268 11.1.4.1 Description

4269 This use case demonstrates how to attach a TOSCA **BlockStorage** node to a **Compute** node using the  
4270 normative **AttachesTo** relationship.

4271 **11.1.4.2 Logical Diagram**

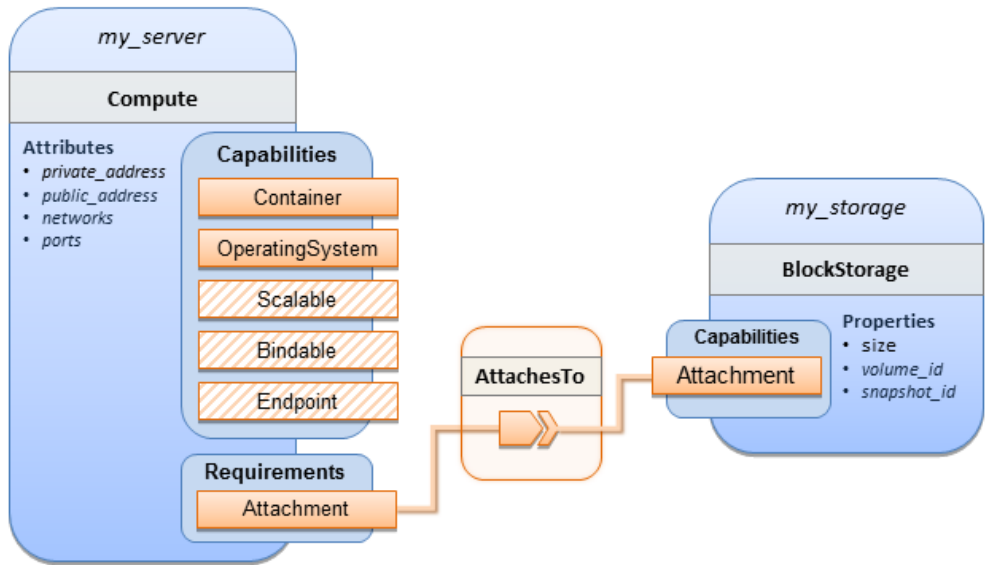

4272

4273 **11.1.4.3 Sample YAML**

```

tosca_definitions_version: toska_simple_yaml_1_0

description: >
  TOSCA simple profile with server and attached block storage using the normative
  AttachesTo Relationship Type.

topology_template:

  inputs:
    cpus:
      type: integer
      description: Number of CPUs for the server.
      constraints:
        - valid_values: [ 1, 2, 4, 8 ]
    storage_size:
      type: scalar-unit.size
      description: Size of the storage to be created.
      default: 1 GB
    storage_snapshot_id:
      type: string
      description: >
        Optional identifier for an existing snapshot to use when creating
        storage.
    storage_location:

```

```

    type: string
    description: Block storage mount point (filesystem path).

node_templates:
  my_server:
    type: Compute
    capabilities:
      host:
        properties:
          disk_size: 10 GB
          num_cpus: { get_input: cpus }
          mem_size: 1 GB
        os:
          properties:
            architecture: x86_64
            type: linux
            distribution: fedora
            version: 18.0
      requirements:
        - local_storage:
            node: my_storage
            relationship:
              type: AttachesTo
              properties:
                location: { get_input: storage_location }

    my_storage:
      type: BlockStorage
      properties:
        size: { get_input: storage_size }
        snapshot_id: { get_input: storage_snapshot_id }

  outputs:
    private_ip:
      description: The private IP address of the newly created compute instance.
      value: { get_attribute: [my_server, private_address] }
    volume_id:
      description: The volume id of the block storage instance.
      value: { get_attribute: [my_storage, volume_id] }

```

4274 **11.1.5 Block Storage 2: Using a custom AttachesTo Relationship Type**

4275 **11.1.5.1 Description**

4276 This use case demonstrates how to attach a TOSCA **BlockStorage** node to a **Compute** node using a  
4277 custom RelationshipType that derives from the normative **AttachesTo** relationship.

4278 **11.1.5.2 Logical Diagram**

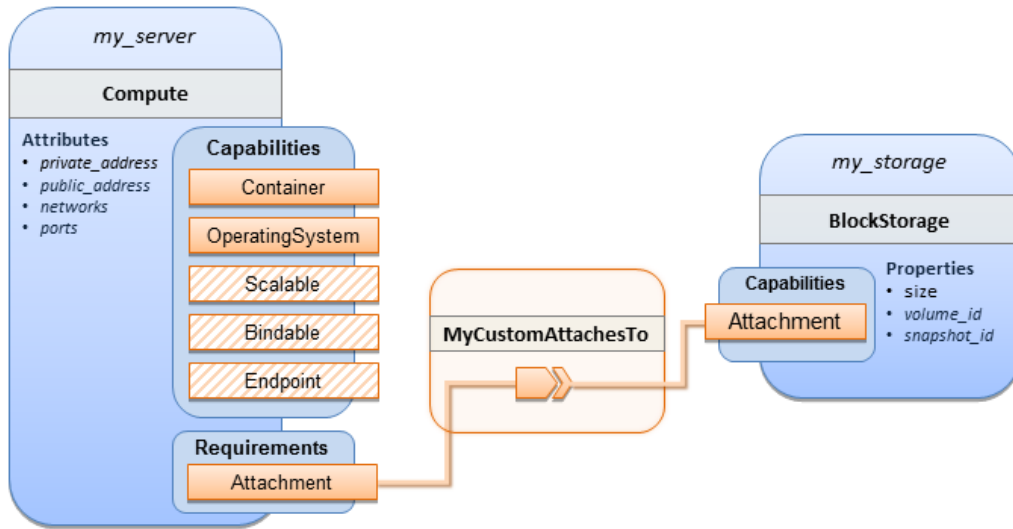

4279

4280 **11.1.5.3 Sample YAML**

4281

```
tosca_definitions_version: tosca_simple_yaml_1_1_0

description: >
  TOSCA simple profile with server and attached block storage using a custom
  AttachesTo Relationship Type.

relationship_types:
  MyCustomAttachesTo:
    derived_from: AttachesTo

topology_template:
  inputs:
    cpus:
      type: integer
      description: Number of CPUs for the server.
      constraints:
        - valid_values: [ 1, 2, 4, 8 ]
    storage_size:
```

```

    type: scalar-unit.size
    description: Size of the storage to be created.
    default: 1 GB
  storage_snapshot_id:
    type: string
    description: >
      Optional identifier for an existing snapshot to use when creating
      storage.
  storage_location:
    type: string
    description: Block storage mount point (filesystem path).

node_templates:
  my_server:
    type: Compute
    capabilities:
      host:
        properties:
          disk_size: 10 GB
          num_cpus: { get_input: cpus }
          mem_size: 4 GB
    os:
      properties:
        architecture: x86_64
        type: Linux
        distribution: Fedora
        version: 18.0
    requirements:
      - local_storage:
          node: my_storage
          # Declare custom AttachesTo type using the 'relationship' keyword
          relationship:
            type: MyCustomAttachesTo
            properties:
              location: { get_input: storage_location }
  my_storage:
    type: BlockStorage
    properties:
      size: { get_input: storage_size }
      snapshot_id: { get_input: storage_snapshot_id }

```



```

outputs:
  private_ip:
    description: The private IP address of the newly created compute instance.
    value: { get_attribute: [my_server, private_address] }
  volume_id:
    description: The volume id of the block storage instance.
    value: { get_attribute: [my_storage, volume_id] }

```

## 4282 11.1.6 Block Storage 3: Using a Relationship Template of type AttachesTo

### 4283 11.1.6.1 Description

4284 This use case demonstrates how to attach a TOSCA **BlockStorage** node to a **Compute** node using a  
 4285 TOSCA Relationship Template that is based upon the normative **AttachesTo** Relationship Type.

### 4286 11.1.6.2 Logical Diagram

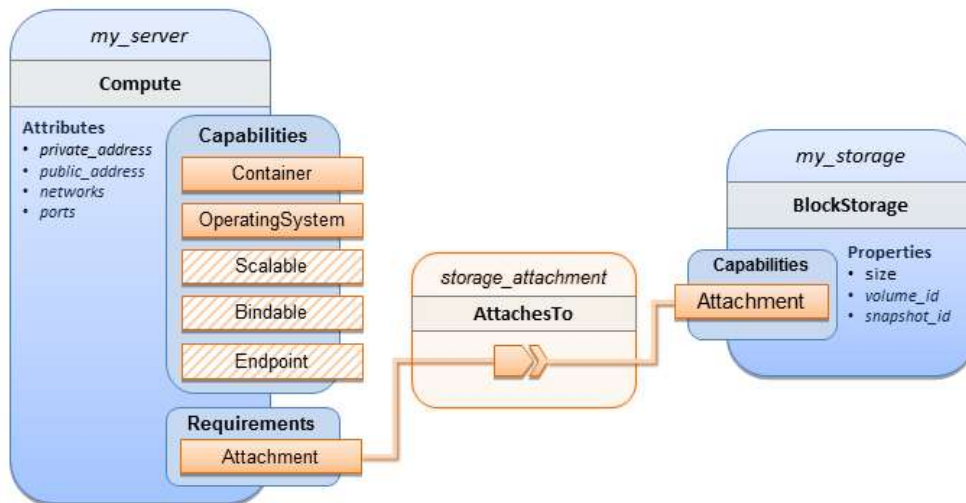

4287

### 4288 11.1.6.3 Sample YAML

4289

```

tosca_definitions_version: tosca_simple_yaml_1_0

description: >
  TOSCA simple profile with server and attached block storage using a named
  Relationship Template for the storage attachment.

topology_template:
  inputs:
    cpus:
      type: integer
      description: Number of CPUs for the server.

```

```

constraints:
  - valid_values: [ 1, 2, 4, 8 ]
storage_size:
  type: scalar-unit.size
  description: Size of the storage to be created.
  default: 1 GB
storage_location:
  type: string
  description: Block storage mount point (filesystem path).

node_templates:
  my_server:
    type: Compute
    capabilities:
      host:
        properties:
          disk_size: 10 GB
          num_cpus: { get_input: cpus }
          mem_size: 4 GB
    os:
      properties:
        architecture: x86_64
        type: Linux
        distribution: Fedora
        version: 18.0
    requirements:
      - local_storage:
          node: my_storage
          # Declare template to use with 'relationship' keyword
          relationship: storage_attachment

  my_storage:
    type: BlockStorage
    properties:
      size: { get_input: storage_size }

relationship_templates:
  storage_attachment:
    type: AttachesTo
    properties:
      location: { get_input: storage_location }

```

```

outputs:
  private_ip:
    description: The private IP address of the newly created compute instance.
    value: { get_attribute: [my_server, private_address] }
  volume_id:
    description: The volume id of the block storage instance.
    value: { get_attribute: [my_storage, volume_id] }

```

4290 **11.1.7 Block Storage 4: Single Block Storage shared by 2-Tier Application**  
 4291 **with custom AttachesTo type and implied relationships**

4292 **11.1.7.1 Description**

4293 This use case shows 2 compute instances (2 tiers) with one BlockStorage node, and also uses a custom  
 4294 **AttachesTo** Relationship that provides a default mount point (i.e., **location**) which the 1<sup>st</sup> tier uses,  
 4295 but the 2<sup>nd</sup> tier provides a different mount point.

4296

4297 Please note that this use case assumes both Compute nodes are accessing different directories within  
 4298 the shared, block storage node to avoid collisions.

4299 **11.1.7.2 Logical Diagram**

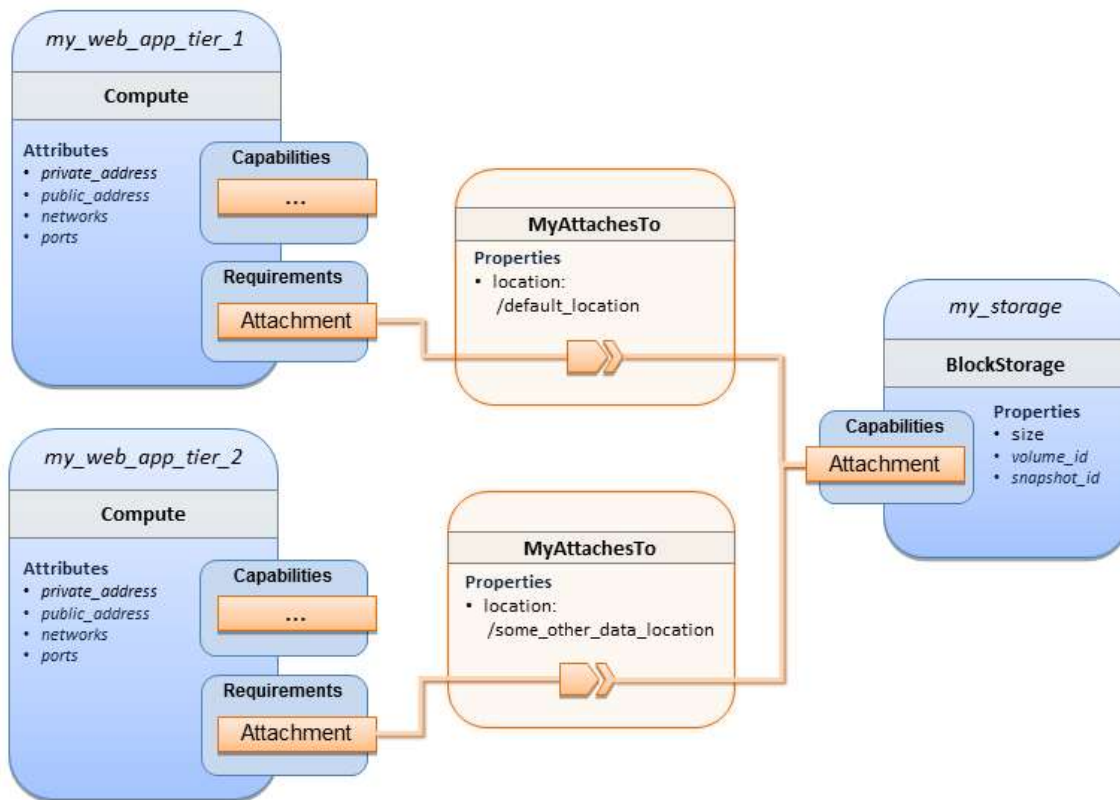

4300

```

tosca_definitions_version: tosca_simple_yaml_1_0

description: >
  TOSCA simple profile with a Single Block Storage node shared by 2-Tier Application with
  custom AttachesTo Type and implied relationships.

relationship_types:
  MyAttachesTo:
    derived_from: tosca.relationships.AttachesTo
    properties:
      location:
        type: string
        default: /default_location

topology_template:
  inputs:
    cpus:
      type: integer
      description: Number of CPUs for the server.
      constraints:
        - valid_values: [ 1, 2, 4, 8 ]
    storage_size:
      type: scalar-unit.size
      default: 1 GB
      description: Size of the storage to be created.
    storage_snapshot_id:
      type: string
      description: >
        Optional identifier for an existing snapshot to use when creating
        storage.

  node_templates:
    my_web_app_tier_1:
      type: tosca.nodes.Compute
      capabilities:
        host:
          properties:
            disk_size: 10 GB
            num_cpus: { get_input: cpus }
            mem_size: 4096 MB

```

```

    os:
      properties:
        architecture: x86_64
        type: Linux
        distribution: Fedora
        version: 18.0
      requirements:
        - local_storage:
            node: my_storage
            relationship: MyAttachesTo

my_web_app_tier_2:
  type: tosca.nodes.Compute
  capabilities:
    host:
      properties:
        disk_size: 10 GB
        num_cpus: { get_input: cpus }
        mem_size: 4096 MB
    os:
      properties:
        architecture: x86_64
        type: Linux
        distribution: Fedora
        version: 18.0
      requirements:
        - local_storage:
            node: my_storage
            relationship:
              type: MyAttachesTo
              properties:
                location: /some_other_data_location

my_storage:
  type: tosca.nodes.BlockStorage
  properties:
    size: { get_input: storage_size }
    snapshot_id: { get_input: storage_snapshot_id }

outputs:
  private_ip_1:

```

```

description: The private IP address of the application's first tier.
value: { get_attribute: [my_web_app_tier_1, private_address] }
private_ip_2:
description: The private IP address of the application's second tier.
value: { get_attribute: [my_web_app_tier_2, private_address] }
volume_id:
description: The volume id of the block storage instance.
value: { get_attribute: [my_storage, volume_id] }

```

4302 **11.1.8 Block Storage 5: Single Block Storage shared by 2-Tier Application**  
4303 **with custom AttachesTo Type and explicit Relationship Templates**

4304 **11.1.8.1 Description**

4305 This use case is like the Notation1 use case, but also creates two relationship templates (one for each  
4306 tier) each of which provide a different mount point (i.e., **location**) which overrides the default location  
4307 defined in the custom Relationship Type.

4308

4309 Please note that this use case assumes both Compute nodes are accessing different directories within  
4310 the shared, block storage node to avoid collisions.

4311 **11.1.8.2 Logical Diagram**

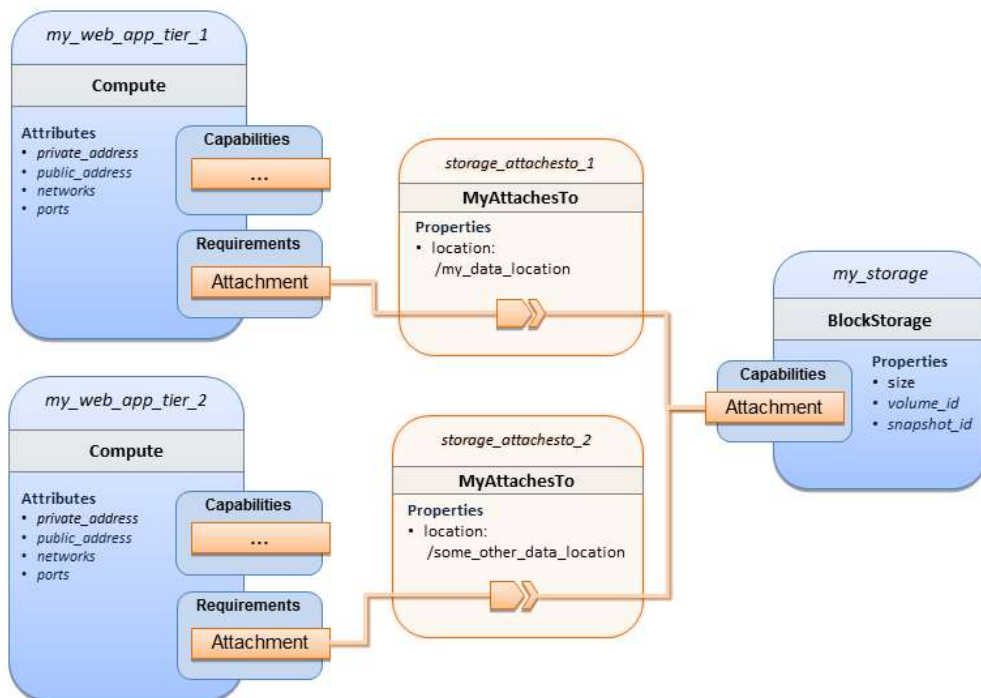

4312

4313 **11.1.8.3 Sample YAML**

```
tosca_definitions_version: tosca_simple_yaml_1_0
```

```

description: >
  TOSCA simple profile with a single Block Storage node shared by 2-Tier Application with
  custom AttachesTo Type and explicit Relationship Templates.

relationship_types:
  MyAttachesTo:
    derived_from: tosca.relationships.AttachesTo
    properties:
      location:
        type: string
        default: /default_location

topology_template:
  inputs:
    cpus:
      type: integer
      description: Number of CPUs for the server.
      constraints:
        - valid_values: [ 1, 2, 4, 8 ]
    storage_size:
      type: scalar-unit.size
      default: 1 GB
      description: Size of the storage to be created.
    storage_snapshot_id:
      type: string
      description: >
        Optional identifier for an existing snapshot to use when creating
        storage.
    storage_location:
      type: string
      description: >
        Block storage mount point (filesystem path).

  node_templates:

    my_web_app_tier_1:
      type: tosca.nodes.Compute
      capabilities:
        host:
          properties:
            disk_size: 10 GB

```

```

    num_cpus: { get_input: cpus }
    mem_size: 4096 MB
  os:
    properties:
      architecture: x86_64
      type: Linux
      distribution: Fedora
      version: 18.0
  requirements:
    - local_storage:
        node: my_storage
        relationship: storage_attachesto_1

my_web_app_tier_2:
  type: toska.nodes.Compute
  capabilities:
    host:
      properties:
        disk_size: 10 GB
        num_cpus: { get_input: cpus }
        mem_size: 4096 MB
    os:
      properties:
        architecture: x86_64
        type: Linux
        distribution: Fedora
        version: 18.0
  requirements:
    - local_storage:
        node: my_storage
        relationship: storage_attachesto_2

my_storage:
  type: toska.nodes.BlockStorage
  properties:
    size: { get_input: storage_size }
    snapshot_id: { get_input: storage_snapshot_id }

relationship_templates:
  storage_attachesto_1:
    type: MyAttachesTo

```



```

properties:
  location: /my_data_location

storage_attachesto_2:
  type: MyAttachesTo
  properties:
    location: /some_other_data_location
outputs:
  private_ip_1:
    description: The private IP address of the application's first tier.
    value: { get_attribute: [my_web_app_tier_1, private_address] }
  private_ip_2:
    description: The private IP address of the application's second tier.
    value: { get_attribute: [my_web_app_tier_2, private_address] }
  volume_id:
    description: The volume id of the block storage instance.
    value: { get_attribute: [my_storage, volume_id] }

```

## 4314 11.1.9 Block Storage 6: Multiple Block Storage attached to different Servers

### 4315 11.1.9.1 Description

4316 This use case demonstrates how two different TOSCA **BlockStorage** nodes can be attached to two  
 4317 different **Compute** nodes (i.e., servers) each using the normative **AttachesTo** relationship.

4318 **11.1.9.2 Logical Diagram**

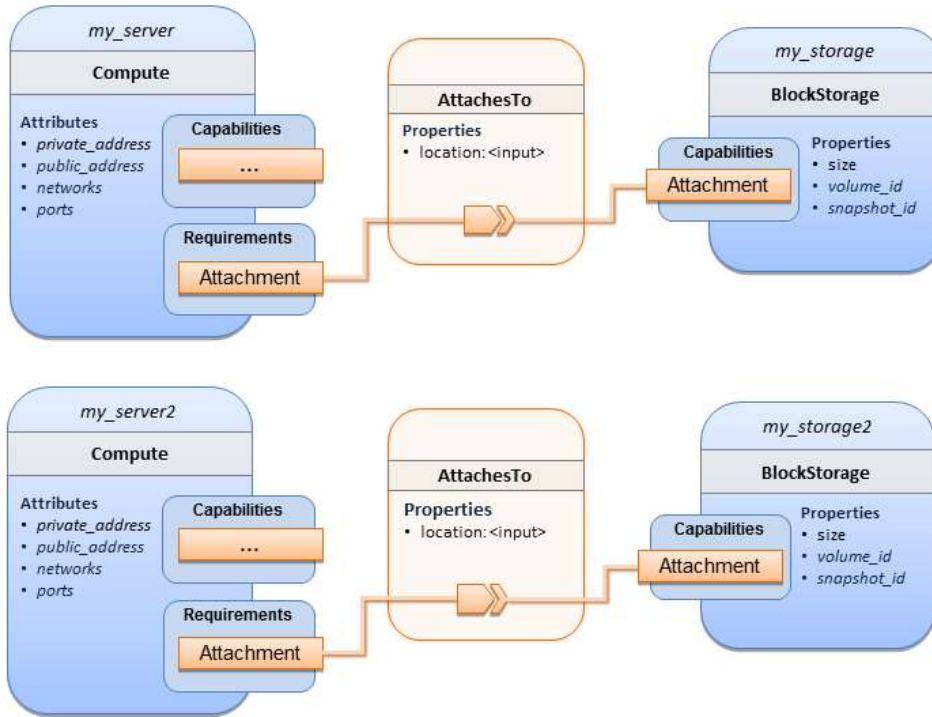

4319

4320 **11.1.9.3 Sample YAML**

```

tosca_definitions_version: toska_simple_yaml_1_0

description: >
  TOSCA simple profile with 2 servers each with different attached block storage.

topology_template:
  inputs:
    cpus:
      type: integer
      description: Number of CPUs for the server.
      constraints:
        - valid_values: [ 1, 2, 4, 8 ]
    storage_size:
      type: scalar-unit.size
      default: 1 GB
      description: Size of the storage to be created.
    storage_snapshot_id:
      type: string
      description: >
  
```

Optional identifier for an existing snapshot to use when creating storage.

storage\_location:

type: string

description: >

Block storage mount point (filesystem path).

node\_templates:

my\_server:

type: toscanodes.Compute

capabilities:

host:

properties:

disk\_size: 10 GB

num\_cpus: { get\_input: cpus }

mem\_size: 4096 MB

os:

properties:

architecture: x86\_64

type: Linux

distribution: Fedora

version: 18.0

requirements:

- local\_storage:

node: my\_storage

relationship:

type: AttachesTo

properties:

location: { get\_input: storage\_location }

my\_storage:

type: toscanodes.BlockStorage

properties:

size: { get\_input: storage\_size }

snapshot\_id: { get\_input: storage\_snapshot\_id }

my\_server2:

type: toscanodes.Compute

capabilities:

host:

properties:

disk\_size: 10 GB

```

    num_cpus: { get_input: cpus }
    mem_size: 4096 MB
  os:
    properties:
      architecture: x86_64
      type: Linux
      distribution: Fedora
      version: 18.0
  requirements:
    - local_storage:
      node: my_storage2
      relationship:
        type: AttachesTo
        properties:
          location: { get_input: storage_location }
  my_storage2:
    type: toska.nodes.BlockStorage
    properties:
      size: { get_input: storage_size }
      snapshot_id: { get_input: storage_snapshot_id }

  outputs:
    server_ip_1:
      description: The private IP address of the application's first server.
      value: { get_attribute: [my_server, private_address] }
    server_ip_2:
      description: The private IP address of the application's second server.
      value: { get_attribute: [my_server2, private_address] }
    volume_id_1:
      description: The volume id of the first block storage instance.
      value: { get_attribute: [my_storage, volume_id] }
    volume_id_2:
      description: The volume id of the second block storage instance.
      value: { get_attribute: [my_storage2, volume_id] }

```

4321 **11.1.10 Object Storage 1: Creating an Object Storage service**

4322 **11.1.10.1 Description**

4323 **11.1.10.2 Logical Diagram**

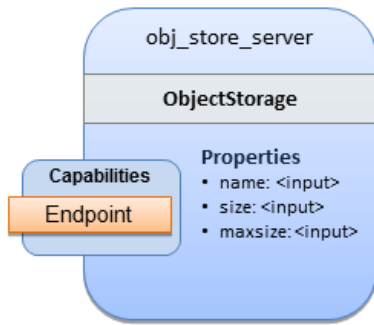

4324

4325 **11.1.10.3 Sample YAML**

```
tosca_definitions_version: tosca_simple_yaml_1_0

description: >
  Tosca template for creating an object storage service.

topology_template:
  inputs:
    objectstore_name:
      type: string

  node_templates:
    obj_store_server:
      type: tosca.nodes.ObjectStorage
      properties:
        name: { get_input: objectstore_name }
        size: 4096 MB
        maxsize: 20 GB
```

4326 **11.1.11 Network 1: Server bound to a new network**

4327 **11.1.11.1 Description**

4328 Introduces the TOSCA **Network** and **Port** nodes used for modeling logical networks using the **LinksTo** and  
4329 **BindsTo** Relationship Types. In this use case, the template is invoked without an existing `network_name`  
4330 as an input property so a new network is created using the properties declared in the Network node.

4331 **11.1.11.2 Logical Diagram**

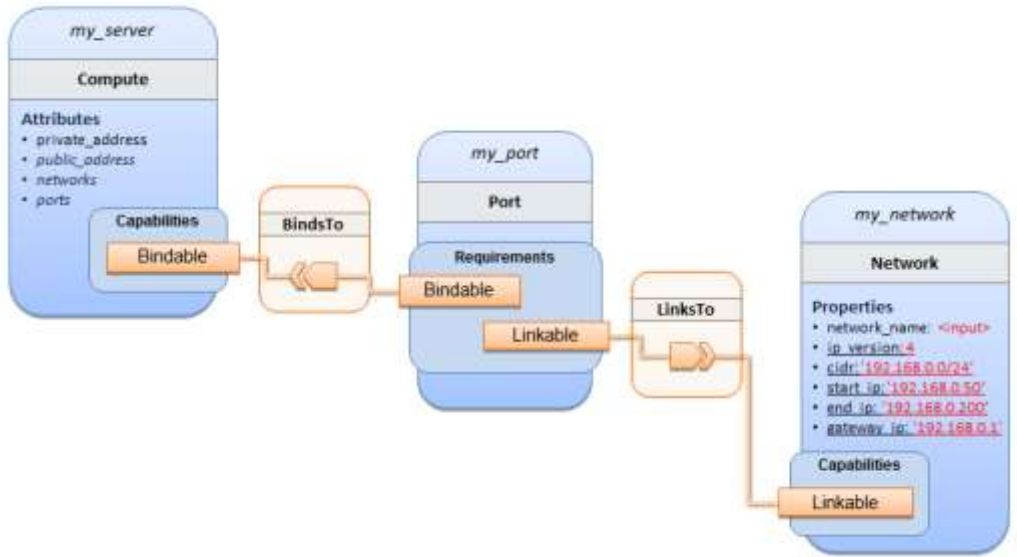

4332

4333 **11.1.11.3 Sample YAML**

```
tosca_definitions_version: tosca_simple_yaml_1_0

description: >
  TOSCA simple profile with 1 server bound to a new network

topology_template:

  inputs:
    network_name:
      type: string
      description: Network name

  node_templates:
    my_server:
      type: tosca.nodes.Compute
      capabilities:
        host:
          properties:
            disk_size: 10 GB
            num_cpus: 1
            mem_size: 4096 MB
          os:
            properties:
              architecture: x86_64
```

```

type: Linux
distribution: CirrOS
version: 0.3.2

my_network:
  type: toska.nodes.network.Network
  properties:
    network_name: { get_input: network_name }
    ip_version: 4
    cidr: '192.168.0.0/24'
    start_ip: '192.168.0.50'
    end_ip: '192.168.0.200'
    gateway_ip: '192.168.0.1'

my_port:
  type: toska.nodes.network.Port
  requirements:
    - binding: my_server
    - link: my_network

```

4334 **11.1.12 Network 2: Server bound to an existing network**

4335 **11.1.12.1 Description**

4336 This use case shows how to use a `network_name` as an input parameter to the template to allow a server  
 4337 to be associated with an existing network.

4338 **11.1.12.2 Logical Diagram**

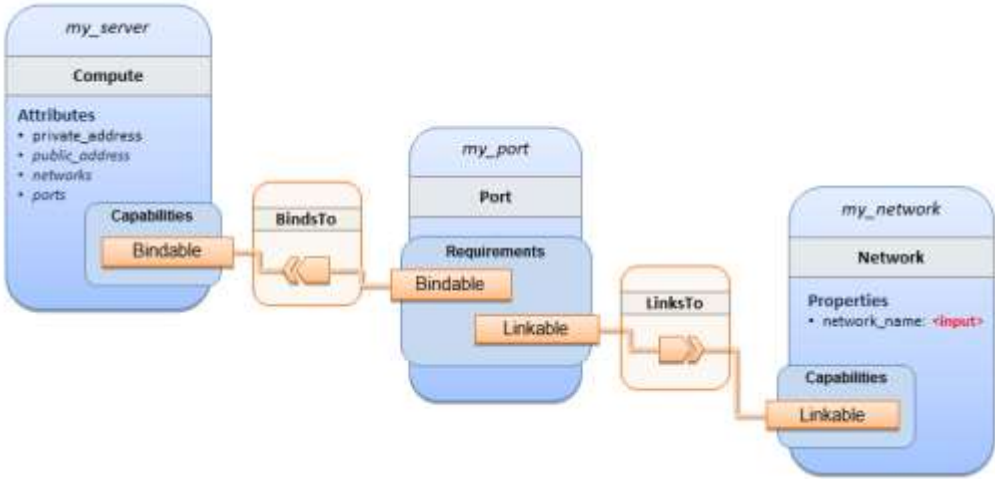

4339

4340 **11.1.12.3 Sample YAML**

```
tosca_definitions_version: tosca_simple_yaml_1_0

description: >
  TOSCA simple profile with 1 server bound to an existing network

topology_template:
  inputs:
    network_name:
      type: string
      description: Network name

  node_templates:
    my_server:
      type: tosca.nodes.Compute
      capabilities:
        host:
          properties:
            disk_size: 10 GB
            num_cpus: 1
            mem_size: 4096 MB
      os:
        properties:
          architecture: x86_64
          type: Linux
          distribution: CirrOS
          version: 0.3.2

    my_network:
      type: tosca.nodes.network.Network
      properties:
        network_name: { get_input: network_name }

    my_port:
      type: tosca.nodes.network.Port
      requirements:
        - binding:
            node: my_server
        - link:
            node: my_network
```



4341 **11.1.13 Network 3: Two servers bound to a single network**

4342 **11.1.13.1 Description**

4343 This use case shows how two servers (**Compute** nodes) can be bound to the same **Network** (node) using  
4344 two logical network **Ports**.

4345 **11.1.13.2 Logical Diagram**

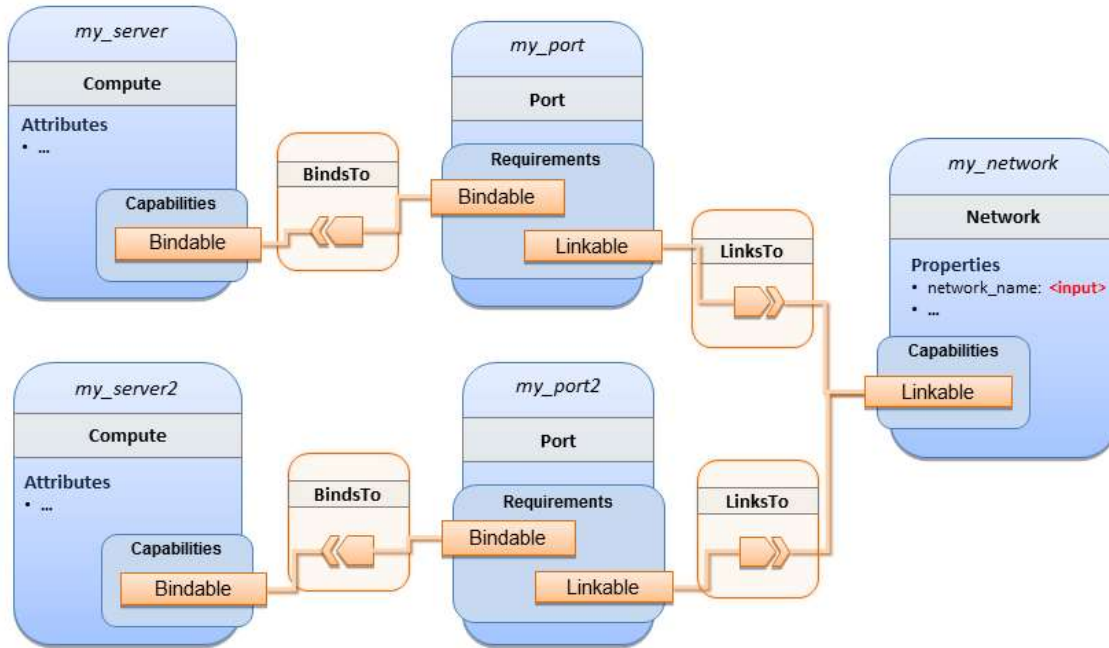

4346

4347 **11.1.13.3 Sample YAML**

```
tosca_definitions_version: toscasimple_yaml_1_0

description: >
  TOSCA simple profile with 2 servers bound to the 1 network

topology_template:

  inputs:
    network_name:
      type: string
      description: Network name
    network_cidr:
      type: string
      default: 10.0.0.0/24
      description: CIDR for the network
    network_start_ip:
```

```
    type: string
    default: 10.0.0.100
    description: Start IP for the allocation pool
network_end_ip:
  type: string
  default: 10.0.0.150
  description: End IP for the allocation pool

node_templates:
  my_server:
    type: toasca.nodes.Compute
    capabilities:
      host:
        properties:
          disk_size: 10 GB
          num_cpus: 1
          mem_size: 4096 MB
        os:
          properties:
            architecture: x86_64
            type: Linux
            distribution: CirrOS
            version: 0.3.2

  my_server2:
    type: toasca.nodes.Compute
    capabilities:
      host:
        properties:
          disk_size: 10 GB
          num_cpus: 1
          mem_size: 4096 MB
        os:
          properties:
            architecture: x86_64
            type: Linux
            distribution: CirrOS
            version: 0.3.2

  my_network:
    type: toasca.nodes.network.Network
```

```
properties:
  ip_version: 4
  cidr: { get_input: network_cidr }
  network_name: { get_input: network_name }
  start_ip: { get_input: network_start_ip }
  end_ip: { get_input: network_end_ip }

my_port:
  type: tosca.nodes.network.Port
  requirements:
    - binding: my_server
    - link: my_network

my_port2:
  type: tosca.nodes.network.Port
  requirements:
    - binding: my_server2
    - link: my_network
```

## 4348 **11.1.14 Network 4: Server bound to three networks**

### 4349 **11.1.14.1 Description**

4350 This use case shows how three logical networks (Network), each with its own IP address range, can be  
4351 bound to with the same server (Compute node).

4352 **11.1.14.2 Logical Diagram**

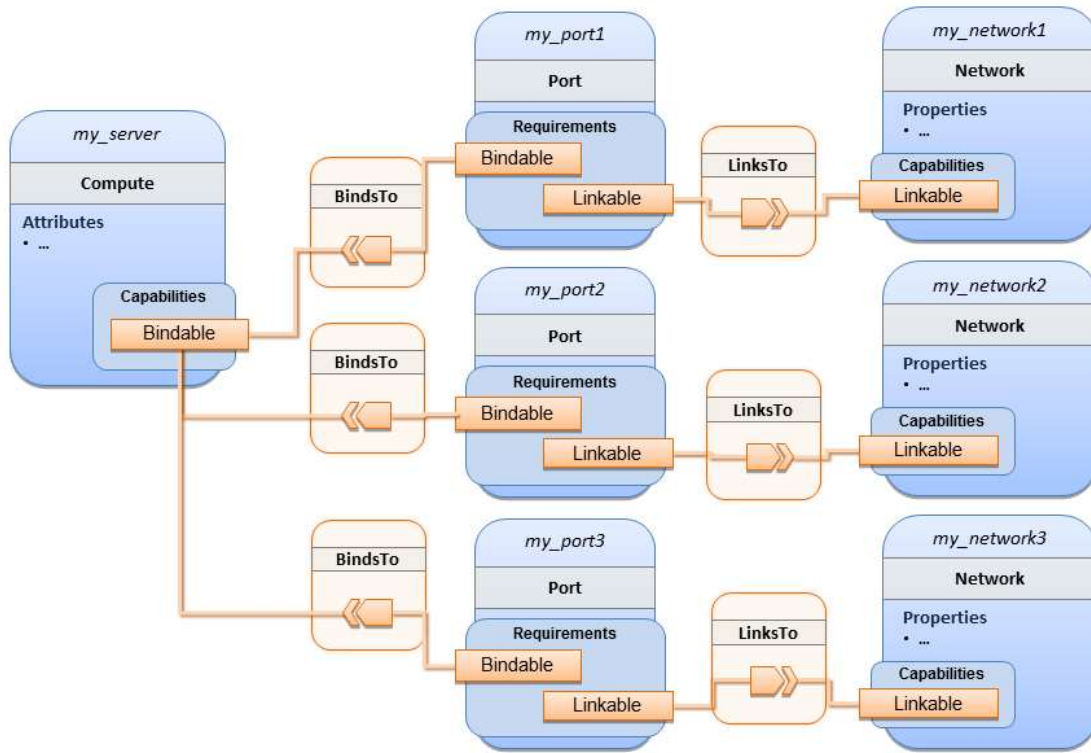

4353

4354 **11.1.14.3 Sample YAML**

```
tosca_definitions_version: toska_simple_yaml_1_0

description: >
  TOSCA simple profile with 1 server bound to 3 networks

topology_template:

  node_templates:
    my_server:
      type: toska.nodes.Compute
      capabilities:
        host:
          properties:
            disk_size: 10 GB
            num_cpus: 1
            mem_size: 4096 MB
        os:
          properties:
            architecture: x86_64
```

```
    type: Linux
    distribution: CirrOS
    version: 0.3.2

my_network1:
  type: toska.nodes.network.Network
  properties:
    cidr: '192.168.1.0/24'
    network_name: net1

my_network2:
  type: toska.nodes.network.Network
  properties:
    cidr: '192.168.2.0/24'
    network_name: net2

my_network3:
  type: toska.nodes.network.Network
  properties:
    cidr: '192.168.3.0/24'
    network_name: net3

my_port1:
  type: toska.nodes.network.Port
  properties:
    order: 0
  requirements:
    - binding: my_server
    - link: my_network1

my_port2:
  type: toska.nodes.network.Port
  properties:
    order: 1
  requirements:
    - binding: my_server
    - link: my_network2

my_port3:
  type: toska.nodes.network.Port
  properties:
```

```

order: 2
requirements:
  - binding: my_server
  - link: my_network3

```

4355 **11.1.15 WebServer-DBMS 1: WordPress + MySQL, single instance**

4356 **11.1.15.1 Description**

4357 TOSCA simple profile service showing the WordPress web application with a MySQL database hosted on  
4358 a single server (instance).

4359 **11.1.15.2 Logical Diagram**

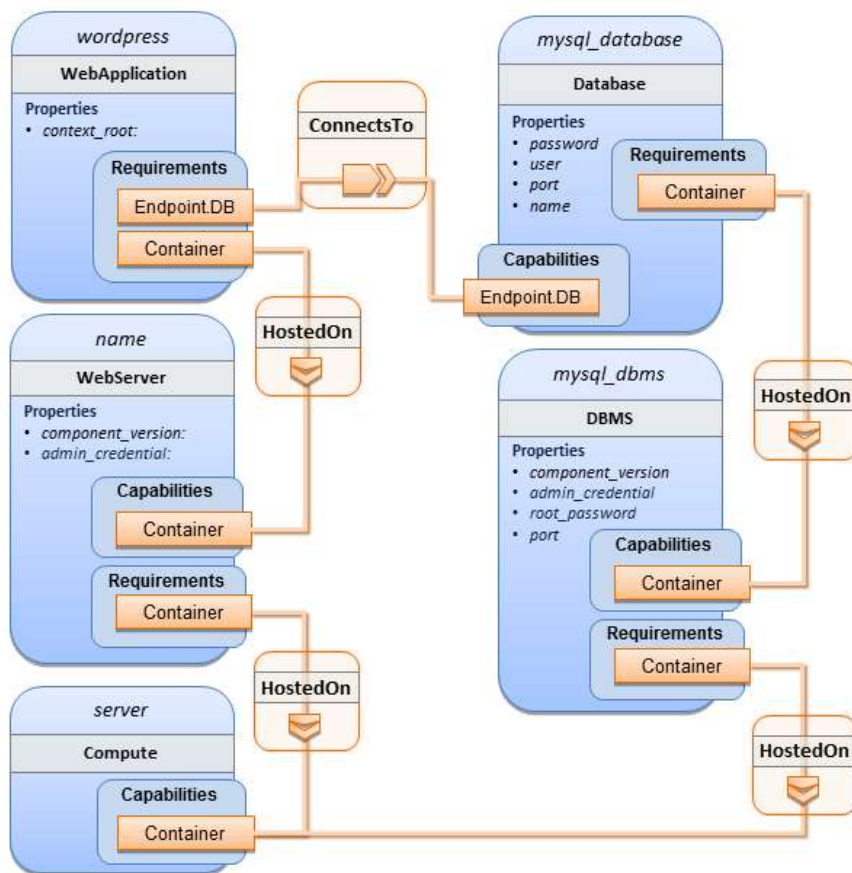

4360

4361 **11.1.15.3 Sample YAML**

```
tosca_definitions_version: tosca_simple_yaml_1_0
```

```
description: >
```

```

TOSCA simple profile with WordPress, a web server, a MySQL DBMS hosting the
application's database content on the same server. Does not have input defaults
or constraints.

```

```

topology_template:
  inputs:
    cpus:
      type: integer
      description: Number of CPUs for the server.
    db_name:
      type: string
      description: The name of the database.
    db_user:
      type: string
      description: The username of the DB user.
    db_pwd:
      type: string
      description: The WordPress database admin account password.
    db_root_pwd:
      type: string
      description: Root password for MySQL.
    db_port:
      type: PortDef
      description: Port for the MySQL database

  node_templates:
    wordpress:
      type: toska.nodes.WebApplication.WordPress
      properties:
        context_root: { get_input: context_root }
      requirements:
        - host: webservers
        - database_endpoint: mysql_database
      interfaces:
        Standard:
          create: wordpress\_install.sh
          configure:
            implementation: wordpress_configure.sh
            inputs:
              wp_db_name: { get_property: [ mysql_database, name ] }
              wp_db_user: { get_property: [ mysql_database, user ] }
              wp_db_password: { get_property: [ mysql_database, password ] }
              # In my own template, find requirement/capability, find port
property

```

```

        wp_db_port: { get_property: [ SELF, database_endpoint, port ] }

mysql_database:
  type: Database
  properties:
    name: { get_input: db_name }
    user: { get_input: db_user }
    password: { get_input: db_pwd }
    port: { get_input: db_port }
  capabilities:
    database_endpoint:
      properties:
        port: { get_input: db_port }
  requirements:
    - host: mysql_dbms
  interfaces:
    Standard:
      configure: mysql_database_configure.sh

mysql_dbms:
  type: DBMS
  properties:
    root_password: { get_input: db_root_pwd }
    port: { get_input: db_port }
  requirements:
    - host: server
  interfaces:
    Standard:
      inputs:
        db_root_password: { get_property: [ mysql_dbms, root_password ] }
      create: mysql_dbms_install.sh
      start: mysql_dbms_start.sh
      configure: mysql_dbms_configure.sh

webservice:
  type: WebServer
  requirements:
    - host: server
  interfaces:
    Standard:
      create: webservice_install.sh

```



```

    start: webservers\_start.sh

server:
  type: Compute
  capabilities:
    host:
      properties:
        disk_size: 10 GB
        num_cpus: { get_input: cpus }
        mem_size: 4096 MB
    os:
      properties:
        architecture: x86_64
        type: linux
        distribution: fedora
        version: 17.0

outputs:
  website_url:
    description: URL for Wordpress wiki.
    value: { get_attribute: [server, public_address] }

```

#### 4362 [11.1.15.4 Sample scripts](#)

4363 Where the referenced implementation scripts in the example above would have the following contents

##### 4364 [11.1.15.4.1 wordpress\\_install.sh](#)

```
yum -y install wordpress
```

##### 4365 [11.1.15.4.2 wordpress\\_configure.sh](#)

```

sed -i "/Deny from All/d" /etc/httpd/conf.d/wordpress.conf
sed -i "s/Require local/Require all granted/" /etc/httpd/conf.d/wordpress.conf
sed -i s/database_name_here/name/ /etc/wordpress/wp-config.php
sed -i s/username_here/user/ /etc/wordpress/wp-config.php
sed -i s/password_here/password/ /etc/wordpress/wp-config.php
systemctl restart httpd.service

```

##### 4366 [11.1.15.4.3 mysql\\_database\\_configure.sh](#)

```

# Setup MySQL root password and create user
cat << EOF | mysql -u root --password=db_root_password

```

```
CREATE DATABASE name;
GRANT ALL PRIVILEGES ON name.* TO "user"@"localhost"
IDENTIFIED BY "password";
FLUSH PRIVILEGES;
EXIT
EOF
```

#### 4367 **11.1.15.4.4 mysql\_dbms\_install.sh**

```
yum -y install mysql mysql-server
# Use systemd to start MySQL server at system boot time
systemctl enable mysqld.service
```

#### 4368 **11.1.15.4.5 mysql\_dbms\_start.sh**

```
# Start the MySQL service (NOTE: may already be started at image boot time)
systemctl start mysqld.service
```

#### 4369 **11.1.15.4.6 mysql\_dbms\_configure**

```
# Set the MySQL server root password
mysqladmin -u root password db_root_password
```

#### 4370 **11.1.15.4.7 webserver\_install.sh**

```
yum -y install httpd
systemctl enable httpd.service
```

#### 4371 **11.1.15.4.8 webserver\_start.sh**

```
# Start the httpd service (NOTE: may already be started at image boot time)
systemctl start httpd.service
```

### 4372 **11.1.16 WebServer-DBMS 2: Nodejs with PayPal Sample App and MongoDB** 4373 **on separate instances**

#### 4374 **11.1.16.1 Description**

4375 This use case Instantiates a 2-tier application with Nodejs and its (PayPal sample) WebApplication on  
4376 one tier which connects a MongoDB database (which stores its application data) using a ConnectsTo  
4377 relationship.

4378 **11.1.16.2 Logical Diagram**

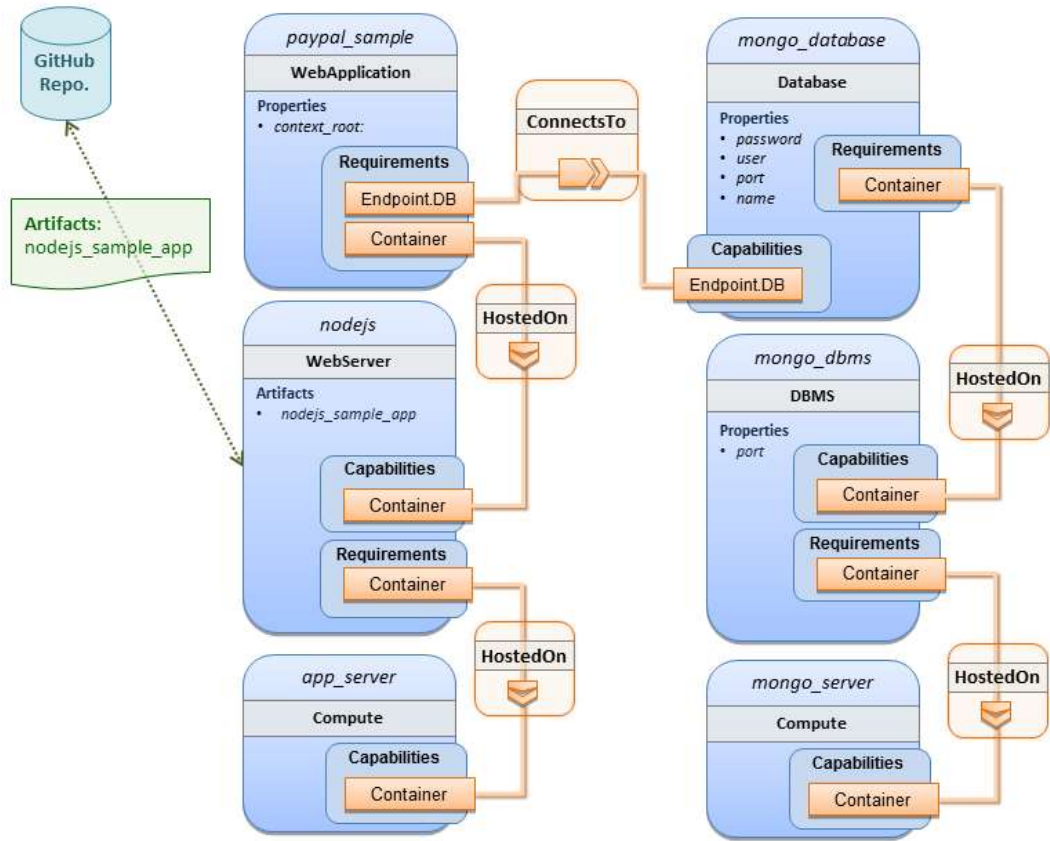

4379

4380 **11.1.16.3 Sample YAML**

```
tosca_definitions_version: tosca_simple_yaml_1_0

description: >
  TOSCA simple profile with a nodejs web server hosting a PayPal sample
  application which connects to a mongodb database.

imports:
  - custom_types/paypalpizzastore_nodejs_app.yaml

dsl_definitions:
  ubuntu_node: &ubuntu_node
    disk_size: 10 GB
    num_cpus: { get_input: my_cpus }
    mem_size: 4096 MB
  os_capabilities: &os_capabilities
    architecture: x86_64
    type: Linux
```

```

distribution: Ubuntu
version: 14.04

topology_template:
  inputs:
    my_cpus:
      type: integer
      description: Number of CPUs for the server.
      constraints:
        - valid_values: [ 1, 2, 4, 8 ]
      default: 1
    github_url:
      type: string
      description: The URL to download nodejs.
      default: https://github.com/sample.git

  node_templates:

    paypal_pizzastore:
      type: tosca.nodes.WebApplication.PayPalPizzaStore
      properties:
        github_url: { get_input: github_url }
      requirements:
        - host:nodejs
        - database_connection: mongo_db
      interfaces:
        Standard:
          configure:
            implementation: scripts/nodejs/configure.sh
            inputs:
              github_url: { get_property: [ SELF, github_url ] }
              mongodb_ip: { get_attribute: [ mongo_server, private_address ] }
          start: scriptsscripts/nodejs/start.sh

    nodejs:
      type: tosca.nodes.WebServer.Nodejs
      requirements:
        - host: app_server
      interfaces:
        Standard:
          create: scripts/nodejs/create.sh

```

```

mongo_db:
  type: toska.nodes.Database
  requirements:
    - host: mongo_dbms
  interfaces:
    Standard:
      create: create_database.sh

mongo_dbms:
  type: toska.nodes.DBMS
  requirements:
    - host: mongo_server
  properties:
    port: 27017
  interfaces:
    toska.interfaces.node.lifecycle.Standard:
      create: mongoddb/create.sh
      configure:
        implementation: mongoddb/config.sh
      inputs:
        mongoddb_ip: { get_attribute: [mongo_server, private_address] }
      start: mongoddb/start.sh

mongo_server:
  type: toska.nodes.Compute
  capabilities:
    os:
      properties: *os_capabilities
    host:
      properties: *ubuntu_node

app_server:
  type: toska.nodes.Compute
  capabilities:
    os:
      properties: *os_capabilities
    host:
      properties: *ubuntu_node

outputs:

```

```

nodejs_url:
  description: URL for the nodejs server, http://<IP>:3000
  value: { get_attribute: [app_server, private_address] }
mongodb_url:
  description: URL for the mongodb server.
  value: { get_attribute: [ mongo_server, private_address ] }

```

4381 **11.1.16.4 Notes:**

- 4382       • Scripts referenced in this example are assumed to be placed by the TOSCA orchestrator in the  
4383       relative directory declared in TOSCA.meta of the TOSCA CSAR file.

4384 **11.1.17 Multi-Tier-1: Elasticsearch, Logstash, Kibana (ELK) use case with**  
4385 **multiple instances**

4386 **11.1.17.1 Description**

4387 TOSCA simple profile service showing the Nodejs, MongoDB, Elasticsearch, Logstash, Kibana, rsyslog  
4388 and collectd installed on a different server (instance).

4389  
4390 This use case also demonstrates:

- 4391       • Use of TOSCA macros or dsl\_definitions  
4392       • Multiple **SoftwareComponents** hosted on same Compute node  
4393       • Multiple tiers communicating to each other over ConnectsTo using Configure interface.

4394 **11.1.17.2 Logical Diagram**

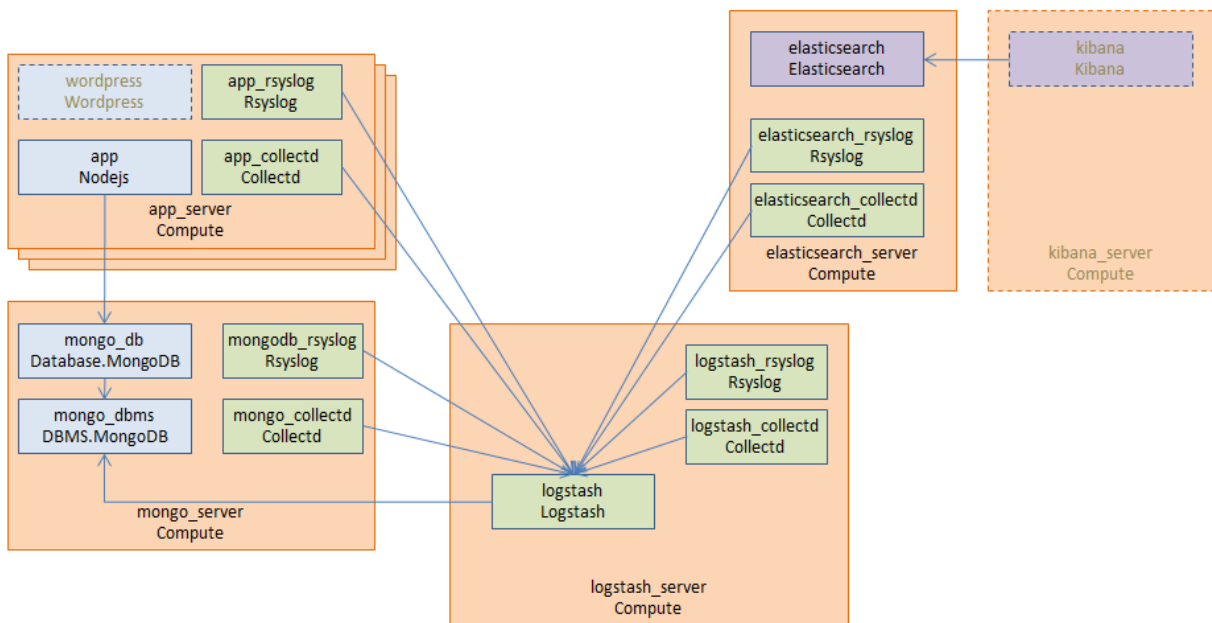

4395

### 4396 11.1.17.3 Sample YAML

#### 4397 11.1.17.3.1 Master Service Template application (Entry-Definitions)

4398 The following YAML is the primary template (i.e., the Entry-Definition) for the overall use case. The  
4399 imported YAML for the various subcomponents are not shown here for brevity.

4400

```
tosca_definitions_version: tosca_simple_yaml_1_0

description: >
  This TOSCA simple profile deploys nodejs, mongodb, elasticsearch, logstash and kibana each on a separate server with monitoring enabled for nodejs server where a sample nodejs application is running. The syslog and collectd are installed on a nodejs server.

imports:
  - paypalpizzastore_nodejs_app.yaml
  - elasticsearch.yaml
  - logstash.yaml
  - kibana.yaml
  - collectd.yaml
  - rsyslog.yaml

dsl_definitions:
  host_capabilities: &host_capabilities
    # container properties (flavor)
    disk_size: 10 GB
    num_cpus: { get_input: my_cpus }
    mem_size: 4096 MB
  os_capabilities: &os_capabilities
    architecture: x86_64
    type: Linux
    distribution: Ubuntu
    version: 14.04

topology_template:
  inputs:
    my_cpus:
      type: integer
      description: Number of CPUs for the server.
      constraints:
        - valid_values: [ 1, 2, 4, 8 ]
  github_url:
```

```

    type: string
    description: The URL to download nodejs.
    default: https://github.com/sample.git

node_templates:
  paypal_pizzastore:
    type: tosca.nodes.WebApplication.PayPalPizzaStore
    properties:
      github_url: { get_input: github_url }
    requirements:
      - host: nodejs
      - database_connection: mongo_db
    interfaces:
      Standard:
        configure:
          implementation: scripts/nodejs/configure.sh
        inputs:
          github_url: { get_property: [ SELF, github_url ] }
          mongodb_ip: { get_attribute: [ mongo_server, private_address ] }
        start: scripts/nodejs/start.sh

nodejs:
  type: tosca.nodes.WebServer.Nodejs
  requirements:
    - host: app_server
  interfaces:
    Standard:
      create: scripts/nodejs/create.sh

mongo_db:
  type: tosca.nodes.Database
  requirements:
    - host: mongo_dbms
  interfaces:
    Standard:
      create: create_database.sh

mongo_dbms:
  type: tosca.nodes.DBMS
  requirements:
    - host: mongo_server

```



```

interfaces:
  toska.interfaces.node.lifecycle.Standard:
    create: scripts/mongodb/create.sh
    configure:
      implementation: scripts/mongodb/config.sh
    inputs:
      mongodb_ip: { get_attribute: [mongo_server, ip_address] }
    start: scripts/mongodb/start.sh

elasticsearch:
  type: toska.nodes.SoftwareComponent.Elasticsearch
  requirements:
    - host: elasticsearch_server
  interfaces:
    toska.interfaces.node.lifecycle.Standard:
      create: scripts/elasticsearch/create.sh
      start: scripts/elasticsearch/start.sh
logstash:
  type: toska.nodes.SoftwareComponent.Logstash
  requirements:
    - host: logstash_server
    - search_endpoint: elasticsearch
  interfaces:
    toska.interfaces.relationship.Configure:
      pre_configure_source:
        implementation: python/logstash/configure_elasticsearch.py
      input:
        elasticsearch_ip: { get_attribute: [elasticsearch_server,
ip_address] }
  interfaces:
    toska.interfaces.node.lifecycle.Standard:
      create: scripts/logstash/create.sh
      configure: scripts/logstash/config.sh
      start: scripts/logstash/start.sh

kibana:
  type: toska.nodes.SoftwareComponent.Kibana
  requirements:
    - host: kibana_server
    - search_endpoint: elasticsearch
  interfaces:

```

```

tosca.interfaces.node.lifecycle.Standard:
  create: scripts/kibana/create.sh
  configure:
    implementation: scripts/kibana/config.sh
    input:
      elasticsearch_ip: { get_attribute: [elasticsearch_server,
ip_address] }
      kibana_ip: { get_attribute: [kibana_server, ip_address] }
  start: scripts/kibana/start.sh

app_collectd:
  type: tosca.nodes.SoftwareComponent.Collectd
  requirements:
    - host: app_server
    - collectd_endpoint: logstash
  interfaces:
    tosca.interfaces.relationship.Configure:
      pre_configure_target:
        implementation: python/logstash/configure_collectd.py
  interfaces:
    tosca.interfaces.node.lifecycle.Standard:
      create: scripts/collectd/create.sh
      configure:
        implementation: python/collectd/config.py
        input:
          logstash_ip: { get_attribute: [logstash_server, ip_address] }
      start: scripts/collectd/start.sh

app_rsyslog:
  type: tosca.nodes.SoftwareComponent.Rsyslog
  requirements:
    - host: app_server
    - rsyslog_endpoint: logstash
  interfaces:
    tosca.interfaces.relationship.Configure:
      pre_configure_target:
        implementation: python/logstash/configure_rsyslog.py
  interfaces:
    tosca.interfaces.node.lifecycle.Standard:
      create: scripts/rsyslog/create.sh
      configure:

```

```

    implementation: scripts/rsyslog/config.sh
    input:
      logstash_ip: { get_attribute: [logstash_server, ip_address] }
    start: scripts/rsyslog/start.sh

app_server:
  type: tosca.nodes.Compute
  capabilities:
    host:
      properties: *host_capabilities
    os:
      properties: *os_capabilities

mongo_server:
  type: tosca.nodes.Compute
  capabilities:
    host:
      properties: *host_capabilities
    os:
      properties: *os_capabilities

elasticsearch_server:
  type: tosca.nodes.Compute
  capabilities:
    host:
      properties: *host_capabilities
    os:
      properties: *os_capabilities

logstash_server:
  type: tosca.nodes.Compute
  capabilities:
    host:
      properties: *host_capabilities
    os:
      properties: *os_capabilities

kibana_server:
  type: tosca.nodes.Compute
  capabilities:
    host:

```

```

    properties: *host_capabilities
  os:
    properties: *os_capabilities

outputs:
  nodejs_url:
    description: URL for the nodejs server.
    value: { get_attribute: [ app_server, private_address ] }
  mongodb_url:
    description: URL for the mongodb server.
    value: { get_attribute: [ mongo_server, private_address ] }
  elasticsearch_url:
    description: URL for the elasticsearch server.
    value: { get_attribute: [ elasticsearch_server, private_address ] }
  logstash_url:
    description: URL for the logstash server.
    value: { get_attribute: [ logstash_server, private_address ] }
  kibana_url:
    description: URL for the kibana server.
    value: { get_attribute: [ kibana_server, private_address ] }

```

#### 4401 **11.1.17.4 Sample scripts**

4402 Where the referenced implementation scripts in the example above would have the following contents

### 4403 **11.1.18 Container-1: Containers using Docker single Compute instance** 4404 **(Containers only)**

#### 4405 **11.1.18.1 Description**

4406 This use case shows a minimal description of two Container nodes (only) providing their Docker  
4407 Requirements allowing platform (orchestrator) to select/provide the underlying Docker implementation  
4408 (Capability). Specifically, wordpress and mysql Docker images are referenced from Docker Hub.

4409

4410 This use case also demonstrates:

- 4411 • Abstract description of Requirements (i.e., Container and Docker) allowing platform to
- 4412 dynamically select the appropriate runtime Capabilities that match.
- 4413 • Use of external repository (Docker Hub) to reference image artifact.

4414 **11.1.18.2 Logical Diagram**

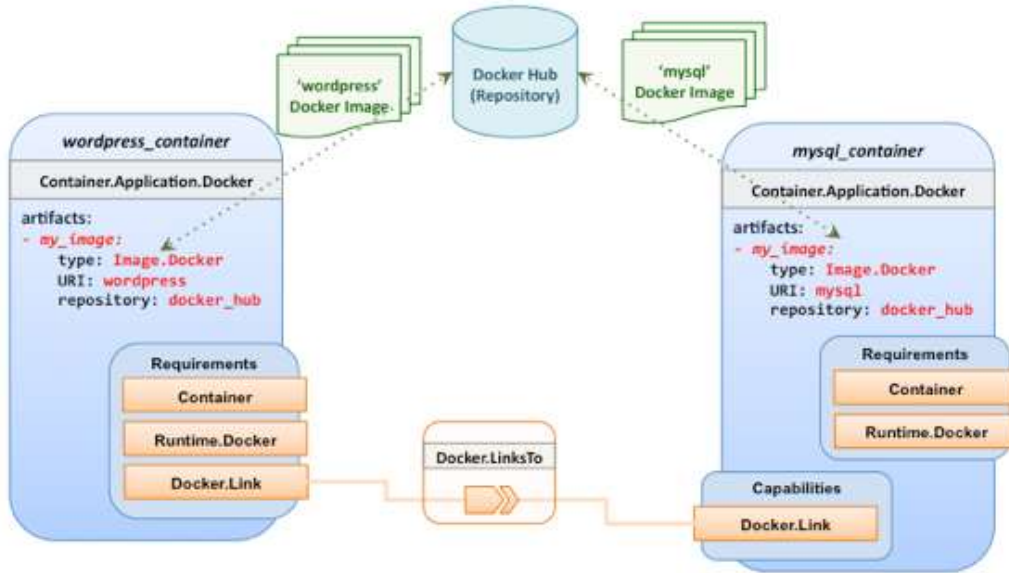

4415

4416 **11.1.18.3 Sample YAML**

4417 **11.1.18.3.1 Two Docker “Container” nodes (Only) with Docker Requirements**

```

tosca_definitions_version: tosca_simple_yaml_1_0

description: >
  TOSCA simple profile with wordpress, web server and mysql on the same server.

# Repositories to retrieve code artifacts from
repositories:
  docker_hub: https://registry.hub.docker.com/

topology_template:

  inputs:
    wp_host_port:
      type: integer
      description: The host port that maps to port 80 of the WordPress container.
    db_root_pwd:
      type: string
      description: Root password for MySQL.

  node_templates:
    # The MYSQL container based on official MySQL image in Docker hub

```

```

mysql_container:
  type: tosca.nodes.Container.Application.Docker
  capabilities:
    # This is a capability that would mimic the Docker -link feature
    database_link: tosca.capabilities.Docker.Link
  artifacts:
    my_image:
      file: mysql
      type: tosca.artifacts.Deployment.Image.Container.Docker
      repository: docker_hub
  interfaces:
    Standard:
      create:
        implementation: my_image
        inputs:
          db_root_password: { get_input: db_root_pwd }

# The WordPress container based on official WordPress image in Docker hub
wordpress_container:
  type: tosca.nodes.Container.Application.Docker
  requirements:
    - database_link: mysql_container
  artifacts:
    my_image:
      file: wordpress
      type: tosca.artifacts.Deployment.Image.Container.Docker
      repository: docker_hub
      <metadata-link> : <topology_artifact_name> # defined outside and linked
to from here
  interfaces:
    Standard:
      create:
        implementation: my_image
        inputs:
          host_port: { get_input: wp_host_port }

```

4418

4419

## 12 TOSCA Policies

4420 This section is **non-normative** and describes the approach TOSCA Simple Profile plans to take for policy  
4421 description with TOSCA Service Templates. In addition, it explores how existing TOSCA Policy Types  
4422 and definitions might be applied in the future to express operational policy use cases.

### 12.1 A declarative approach

4424 TOSCA Policies are a type of requirement that govern use or access to resources which can be  
4425 expressed independently from specific applications (or their resources) and whose fulfillment is not  
4426 discretely expressed in the application's topology (i.e., via TOSCA Capabilities).

4427

4428 TOSCA deems it not desirable for a declarative model to encourage external intervention for resolving  
4429 policy issues (i.e., via imperative mechanisms external to the Cloud). Instead, the Cloud provider is  
4430 deemed to be in the best position to detect when policy conditions are triggered, analyze the affected  
4431 resources and enforce the policy against the allowable actions declared within the policy itself.

#### 12.1.1 Declarative considerations

- 4433 • Natural language rules are not realistic, too much to represent in our specification; however, regular  
4434 expressions can be used that include simple operations and operands that include symbolic names  
4435 for TOSCA metamodel entities, properties and attributes.
- 4436 • Complex rules can actually be directed to an external policy engine (to check for violation) returns  
4437 true/false then policy says what to do (trigger or action).
- 4438 • Actions/Triggers could be:
  - 4439 • Autonomic/Platform corrects against user-supplied criteria
  - 4440 • External monitoring service could be utilized to monitor policy rules/conditions against metrics,  
4441 the monitoring service could coordinate corrective actions with external services (perhaps  
4442 Workflow engines that can analyze the application and interact with the TOSCA instance model).

### 12.2 Consideration of Event, Condition and Action

#### 12.3 Types of policies

4445 Policies typically address two major areas of concern for customer workloads:

- 4446 • **Access Control** – assures user and service access to controlled resources are governed by  
4447 rules which determine general access permission (i.e., allow or deny) and conditional access  
4448 dependent on other considerations (e.g., organization role, time of day, geographic location, etc.).
- 4449 • **Placement** – assures affinity (or anti-affinity) of deployed applications and their resources; that is,  
4450 what is allowed to be placed where within a Cloud provider's infrastructure.
- 4451 • **Quality-of-Service** (and continuity) - assures performance of software components (perhaps  
4452 captured as quantifiable, measure components within an SLA) along with consideration for  
4453 scaling and failover.

##### 12.3.1 Access control policies

4455 Although TOSCA Policy definitions could be used to express and convey access control policies,  
4456 definitions of policies in this area are out of scope for this specification. At this time, TOSCA encourages  
4457 organizations that already have standards that express policy for access control to provide their own  
4458 guidance on how to use their standard with TOSCA.

## 4459 12.3.2 Placement policies

4460 There must be control mechanisms in place that can be part of these patterns that accept governance  
4461 policies that allow control expressions of what is allowed when placing, scaling and managing the  
4462 applications that are enforceable and verifiable in Cloud.

4463

4464 These policies need to consider the following:

- 4465 • Regulated industries need applications to control placement (deployment) of applications to  
4466 different countries or regions (i.e., different logical geographical boundaries).

### 4467 12.3.2.1 Placement for governance concerns

4468 In general, companies and individuals have security concerns along with general “loss of control” issues  
4469 when considering deploying and hosting their highly valued application and data to the Cloud. They want  
4470 to control placement perhaps to ensure their applications are only placed in datacenter they trust or  
4471 assure that their applications and data are not placed on shared resources (i.e., not co-tenanted).

4472

4473 In addition, companies that are related to highly regulated industries where compliance with government,  
4474 industry and corporate policies is paramount. In these cases, having the ability to control placement of  
4475 applications is an especially significant consideration and a prerequisite for automated orchestration.

### 4476 12.3.2.2 Placement for failover

4477 Companies realize that their day-to-day business must continue on through unforeseen disasters that  
4478 might disable instances of the applications and data at or on specific data centers, networks or servers.  
4479 They need to be able to convey placement policies for their software applications and data that mitigate  
4480 risk of disaster by assuring these cloud assets are deployed strategically in different physical locations.  
4481 Such policies need to consider placement across geographic locations as wide as countries, regions,  
4482 datacenters, as well as granular placement on a network, server or device within the same physical  
4483 datacenter. Cloud providers must be able to not only enforce these policies but provide robust and  
4484 seamless failover such that a disaster’s impact is never perceived by the end user.

## 4485 12.3.3 Quality-of-Service (QoS) policies

4486 Quality-of-Service (apart from failover placement considerations) typically assures that software  
4487 applications and data are available and performant to the end users. This is usually something that is  
4488 measurable in terms of end-user responsiveness (or response time) and often qualified in SLAs  
4489 established between the Cloud provider and customer. These QoS aspects can be taken from SLAs and  
4490 legal agreements and further encoded as performance policies associated with the actual applications  
4491 and data when they are deployed. It is assumed that Cloud provider is able to detect high utilization (or  
4492 usage load) on these applications and data that deviate from these performance policies and is able to  
4493 bring them back into compliance.

4494

## 4495 12.4 Policy relationship considerations

- 4496 • Performance policies can be related to scalability policies. Scalability policies tell the Cloud provider  
4497 exactly **how** to scale applications and data when they detect an application’s performance policy is  
4498 (or about to be) violated (or triggered).
- 4499 • Scalability policies in turn are related to placement policies which govern **where** the application and  
4500 data can be scaled to.
- 4501 • There are general “tenant” considerations that restrict what resources are available to applications  
4502 and data based upon the contract a customer has with the Cloud provider. This includes other



4503 constraints imposed by legal agreements or SLAs that are not encoded programmatically or  
4504 associated directly with actual application or data..

## 4505 **12.5 Use Cases**

4506 This section includes some initial operation policy use cases that we wish to describe using the TOSCA  
4507 metamodel. More policy work will be done in future versions of the TOSCA Simple Profile in YAML  
4508 specification.

### 4509 **12.5.1 Placement**

#### 4510 **12.5.1.1 Use Case 1: Simple placement for failover**

##### 4511 **12.5.1.1.1 Description**

4512 This use case shows a failover policy to keep at least 3 copies running in separate containers. In this  
4513 simple case, the specific containers to use (or name is not important; the Cloud provider must assure  
4514 placement separation (anti-affinity) in three physically separate containers.

##### 4515 **12.5.1.1.2 Features**

4516 This use case introduces the following policy features:

- 4517 • Simple separation on different “compute” nodes (up to discretion of provider).
- 4518 • Simple separation by region (a logical container type) using an allowed list of region names  
4519 relative to the provider.
  - 4520 ○ Also, shows that set of allowed “regions” (containers) can be greater than the number of  
4521 containers requested.

##### 4522 **12.5.1.1.3 Logical Diagram**

4523 Sample YAML: Compute separation

```
failover_policy_1:  
  type: toska.policy.placement.Antilocate  
  description: My placement policy for Compute node separation  
  properties:  
    # 3 diff target containers  
    container_type: Compute  
    container_number: 3
```

##### 4524 **12.5.1.1.4 Notes**

- 4525 • There may be availability (constraints) considerations especially if these policies are applied to  
4526 “clusters”.
- 4527 • There may be future considerations for controlling max # of instances per container.

### 4528 **12.5.1.2 Use Case 2: Controlled placement by region**

#### 4529 **12.5.1.2.1 Description**

4530 This use case demonstrates the use of named “containers” which could represent the following:

- 4531 • Datacenter regions

- 4532 • Geographic regions (e.g., cities, municipalities, states, countries, etc.)
- 4533 • Commercial regions (e.g., North America, Eastern Europe, Asia Pacific, etc.)

#### 4534 **12.5.1.2.2 Features**

4535 This use case introduces the following policy features:

- 4536 • Separation of resources (i.e., TOSCA nodes) by logical regions, or zones.

#### 4537 **12.5.1.2.3 Sample YAML: Region separation amongst named set of regions**

```
failover_policy_2:
  type: toska.policy.placement
  description: My failover policy with allowed target regions (logical
containers)
  properties:
    container_type: region
    container_number: 3
    # If "containers" keyname is provided, they represent the allowed set
    # of target containers to use for placement for .
    containers: [ region1, region2, region3, region4 ]
```

#### 4538 **12.5.1.3 Use Case 3: Co-locate based upon Compute affinity**

##### 4539 **12.5.1.3.1 Description**

4540 Nodes that need to be co-located to achieve optimal performance based upon access to similar  
4541 Infrastructure (IaaS) resource types (i.e., Compute, Network and/or Storage).

4542

4543 This use case demonstrates the co-location based upon Compute resource affinity; however, the same  
4544 approach could be taken for Network as or Storage affinity as well. :

##### 4545 **12.5.1.3.2 Features**

4546 This use case introduces the following policy features:

- 4547 • Node placement based upon Compute resource affinity.

##### 4548 **12.5.1.4 Notes**

- 4549 • The concept of placement based upon IaaS resource utilization is not future-thinking, as Cloud  
4550 should guarantee equivalent performance of application performance regardless of placement.  
4551 That is, all network access between application nodes and underlying Compute or Storage should  
4552 have equivalent performance (e.g., network bandwidth, network or storage access time, CPU  
4553 speed, etc.).

#### 4554 **12.5.1.4.1 Sample YAML: Region separation amongst named set of regions**

```
keep_together_policy:
  type: toska.policy.placement.Colocate
  description: Keep associated nodes (groups of nodes) based upon Compute
  properties:
    affinity: Compute
```

### 4555 **12.5.2 Scaling**

#### 4556 **12.5.2.1 Use Case 1: Simple node autoscale**

##### 4557 **12.5.2.1.1 Description**

4558 Start with X nodes and scale up to Y nodes, capability to do this from a dashboard for example.

##### 4559 **12.5.2.1.2 Features**

4560 This use case introduces the following policy features:

- 4561 • Basic autoscaling policy

##### 4562 **12.5.2.1.3 Sample YAML**

```
my_scaling_policy_1:
  type: toska.policy.scaling
  description: Simple node autoscaling
  properties:
    min_instances: <integer>
    max_instances: <integer>
    default_instances: <integer>
    increment: <integer>
```

##### 4563 **12.5.2.1.4 Notes**

- 4564 • Assume horizontal scaling for this use case
  - 4565 ○ Horizontal scaling, implies “stack-level” control using Compute nodes to define a “stack”
  - 4566 (i.e., The Compute node’s entire HostedOn relationship dependency graph is considered
  - 4567 part of its “stack”)
- 4568 • Assume Compute node has a SoftwareComponent that represents a VM application.
- 4569 • Availability Zones (and Regions if not same) need to be considered in further
- 4570 use cases.
- 4571 • If metrics are introduced, there is a control-loop (that monitors). Autoscaling is a special concept
- 4572 that includes these considerations.
- 4573 • Mixed placement and scaling use cases need to be considered:
  - 4574 ○ *Example:* Compute1 and Compute2 are 2 node templates. Compute1 has 10 instances, 5
  - 4575 in one region 5 in other region.

4576

## 13 Artifact Processing and creating portable Service Templates

4577

4578 TOSCA's declarative modelling includes features that allow service designers to model abstract  
4579 components without having to specify concrete implementations for these components. Declarative  
4580 modeling is made possible through the use of standardized TOSCA types. Any TOSCA-compliant  
4581 orchestrator is expected to know how to deploy these standard types. Declarative modeling ensures  
4582 optimal portability of service templates, since any cloud-specific or technology specific implementation  
4583 logic is provided by the TOSCA orchestrator, not by the service template.

4584

4585 The examples in the previous chapter also demonstrate how TOSCA allows service designers to extend  
4586 built-in orchestrator behavior in a number of ways:

- 4587 - Service designers can override or extend behavior of built-in types by supplying service-specific  
4588 implementations of lifecycle interface operations in their node templates.
- 4589 - Service designers can create entirely new types that define custom implementations of standard  
4590 lifecycle interfaces.

4591 Implementations of Interface operations are provided through artifacts. The examples in the previous  
4592 chapter showed shell script artifacts, but many other types of artifacts can be used as well. The use of  
4593 artifacts in TOSCA service templates breaks pure declarative behavior since artifacts effectively contain  
4594 "imperative logic" that is opaque to the orchestrator. This introduces the risk of non-portable templates.  
4595 Since some artifacts may have dependencies on specific technologies or infrastructure component, the  
4596 use of artifacts could result in service templates that cannot be used on all cloud infrastructures.

4597

4598 The goal of this **non-normative** chapter is to ensure portable and interoperable use of artifacts by  
4599 providing a detailed description of how TOSCA orchestrators process artifacts, by illustrating how a  
4600 number of standard TOSCA artifact types are expected to be processed, and by describing TOSCA  
4601 language features that allow artifact to provide metadata containing artifact-specific processing  
4602 instructions. These metadata around the artifact allow the orchestrator to make descisions on the correct  
4603 Artifact Processor and runtime(s) needed to execute. The sole purpose of this chapter is to show TOSCA  
4604 template designers how to best leverage built-in TOSCA capabilities. It is not intended to recommend  
4605 specific orchestrator implementations.

### 13.1 Artifacts Processing

4607 Artifacts represent the content needed to realize a deployment or implement a specific management  
4608 action.

4609

4610 Artifacts can be of many different types. Artifacts could be executables (such as scripts or executable  
4611 program files) or pieces of data required by those executables (e.g. configuration files, software libraries,  
4612 license keys, etc). Implementations for some operations may require the use of multiple artifacts.

4613

4614 Different types of artifacts may require different mechanisms for processing the artifact. However, the  
4615 sequence of steps taken by an orchestrator to process an artifcat is generally the same for all types of  
4616 artifacts:

#### 13.1.1 Identify Artifact Processor

4617 The first step is to identify an appropriate processor for the specified artifact. A processor is any  
4618 executable that knows how to process the artifact in order to achieve the intended management  
4619 operation. This processor could be an interpreter for executable shell scripts or scripts written in Python. It  
4620 could be a tool such as Ansible, Puppet, or Chef for playbook, manifest, or recipe artifacts, or it could be a  
4621

4622 container management or cloud management system for image artifacts such as container images or  
4623 virtual machine images.

4624

4625 TOSCA includes a number of standard artifact types. Standard-compliant TOSCA orchestrators are  
4626 expected to include processors for each of these types. For each type, there is a correspondent Artifact  
4627 Processor that is responsible for processing artifacts of that type.

4628

4629 Note that aside from selecting the proper artifact processor, it may also be important to use the proper  
4630 version of the processor. For example, some python scripts may require Python 2.7 whereas other scripts  
4631 may require Python 3.4. TOSCA provides metadata to describe service template-specific parameters for  
4632 the Artifact Processor. In addition to specifying specific versions, those metadata could also identify  
4633 repositories from which to retrieve the artifact processor.

4634

4635 Some templates may require the use of custom Artifact Processors, for example to process non-standard  
4636 artifacts or to provide a custom Artifact Processor for standard artifact types. For such cases, TOSCA  
4637 allows service template designers to define Application Processors in service templates as a top-level  
4638 entity. Alternatively, service template designers can also provide their own artifact processor by providing  
4639 wrapper artifacts of a supported type. These wrapper artifacts could be shell scripts, python scripts, or  
4640 artifacts of any other standard type that know how process or invoke the custom artifact.

### 4641 **13.1.2 Establish an Execution Environment**

4642 The second step is to identify or create a proper execution environment within which to run the artifact  
4643 processor. There are generally three options for where to run artifact processors :

4644

- 4645 1. One option is to execute the artifact processor in the topology that is being orchestrated, for  
4646 example on a Compute node created by the orchestrator.
- 4647 2. A second option is to process the artifact in the same environment in which the orchestrator is  
4648 running (although for security reasons, orchestrators may create sandboxes that shield the  
4649 orchestrator from faulty or malicious artifacts).
- 4650 3. The third option is to process the script in a management environment that is external to both the  
4651 orchestrator and the topology being orchestrated. This might be the preferred option for scenarios  
4652 where the environment already exists, but it is also possible for orchestrators to create external  
4653 execution environments.

4654 It is often possible for the orchestrator to determine the intended execution environment based on the  
4655 type of the artifact as well as on the topology context in which the the artifact was specified. For example,  
4656 shell script artifacts associated with software components typically contain the install script that needs to  
4657 be executed on the software component's host node in order to install that software component.

4658 However, other scripts may not need to be run inside the topology being orchestrated. For example, a  
4659 script that creates a database on a database management system could run on the compute node that  
4660 hosts the database management system, or it could run in the orchestrator environment and  
4661 communicate with the DBMS across a management network connection.

4662

4663 Similarly, there may be multiple options for other types of artifacts as well. For example, puppet artifacts  
4664 could get processed locally by a puppet agent running on a compute node in the topology, or they could  
4665 get passed to a puppet master that is external to both the orchestrator and the topology.

4666

4667 Different orchestrators could make different decisions about the execution environments for various  
4668 combinations of node types and artifact types. However, service template designers must have the ability  
4669 to specify explicitly where artifacts are intended to be processed in those scenario where correct  
4670 operation depends on using a specific execution environment.

4671           Need discussion on how this is done.

### 4672   **13.1.3 Configure Artifact Processor User Account**

4673   An artifact processor may need to run using a specific user account in the execution environment to  
4674   ensure that the processor has the proper permissions to execute the required actions. Depending on the  
4675   artifact, existing user accounts might get used, or the orchestrator might have to create a new user  
4676   account specifically for the artifact processor. If new user accounts are needed, the orchestrator may also  
4677   have to create a home directory for those users.

4678

4679   Depending on the security mechanisms used in the execution environment, it may also be necessary to  
4680   add user accounts to specific groups, or to assign specific roles to the user account.

### 4681   **13.1.4 Deploy Artifact Processor**

4682   Once the orchestrator has identified the artifact processor as well as the execution environment, it must  
4683   make sure that the artifact processor is deployed in the execution environment:

- 4684       • If the orchestrator's own environment acts as the execution environment for the artifact  
4685       processor, orchestrator implementors can make sure that a standard set of artifact processors is  
4686       pre-installed in that environment, and nothing further may need to be done.
- 4687       • When a Compute node in the orchestrated topology is selected as the execution environment,  
4688       typically only the most basic processors (such as bash shells) are pre-installed on that compute  
4689       node. All other execution processors need to be installed on that compute node by the  
4690       orchestrator.
- 4691       • When an external execution environment is specified, the orchestrator must at the very least be  
4692       able to verify that the proper artifact processor is present in the external execution environment  
4693       and generate an error if it isn't. Ideally, the orchestrator should be able to install the processor if  
4694       necessary.

4695   The orchestrator may also take the necessary steps to make sure the processor is run as a specific user  
4696   in the execution environment.

### 4697   **13.1.5 Deploy Dependencies**

4698   The imperative logic contained in artifacts may in turn install or configure software components that are  
4699   not part of the service topology, and as a result are opaque to the orchestrator. This means that the  
4700   orchestrator cannot reflect these components in an instance model, which also means they cannot be  
4701   managed by the orchestrator.

4702

4703   It is best practice to avoid this situation by explicitly modeling any dependent components that are  
4704   required by an artifact processor. When deploying the artifact processor, the orchestrator can then deploy  
4705   or configure these dependencies in the execution environment and reflect them in an instance model as  
4706   appropriate.

4707

4708   For artifacts that require dependencies to to be installed, TOSCA provides a generic way in which to  
4709   describe those dependencies, which will avoid the use of monolithic scripts.

4710

4711   Examples of dependent components include the following :

- 4712       • Some executables may have dependencies on software libraries. For tools like Python, required  
4713       libraries might be specified in a requirements.txt file and deployed into a virtual environment.
- 4714       • Environment variables may need to be set.

- 4715
- Configuration files may need to be created with proper settings for the artifact processor. For example, configuration settings could include DNS names (or IP addresses) for contacting a Puppet Master or Chef Server.
- 4716
- 4717
- 4718
- Artifact processors may require valid software licenses in order to run.
- 4719
- Other artifacts specified in the template may need to be deposited into the execution environment.
- 4720

### 4721 13.1.6 Identify Target

4722 Orchestrators must pass information to the artifact processor that properly identifies the target for each  
4723 artifact being processed.

- 4724
- In many cases, the target is the Compute node that acts as the host for the node being created or configured. If that Compute node also acts as the execution environment for the artifact processor, the target for the artifacts being processed is the Compute node itself. If that scenario, there is no need for the orchestrator to pass additional target information aside from specifying that all actions are intended to be applied locally.
- 4725
- 4726
- 4727
- 4728
- When artifact processors run externally to the topology being deployed, they must establish a connection across a management network to the target. In TOSCA, such targets are identified using Endpoint capabilities that contain the necessary addressing information. This addressing information must be passed to the artifact processor
- 4729
- 4730
- 4731
- 4732

4733 Note that in addition to endpoint information about the target, orchestrators may also need to pass  
4734 information about the protocol that must be used to connect to the target. For example, some networking  
4735 devices only accept CLI commands across a SSH connection, but others could also accept REST API  
4736 calls. Different python scripts could be used to configure such devices: one that uses the CLI, and one  
4737 that executes REST calls. The artifact must include metadata about which connection mechanism is  
4738 intended to be used, and orchestrators must pass on this information to the artifact processor.

4739 Finally, artifact processor may need proper credentials to connect to target endpoints. Orchestrators must  
4740 pass those credentials to the artifact processor before the artifact can be processed.

### 4741 13.1.7 Pass Inputs and Retrieve Results or Errors

4742 Orchestrators must pass any required inputs to the artifact processor. Some processors could take inputs  
4743 through environment variables, but others may prefer command line arguments. Named or positional  
4744 command line arguments could be used. TOSCA must be very specific about the mechanism for passing  
4745 input data to processors for each type of artifact.

4746

4747 Similarly, artifact processors must also pass results from operations back to orchestrators so that results  
4748 values can be reflected as appropriate in node properties and attributes. If the operation fails, error codes  
4749 may need to be returned as well. TOSCA must be very specific about the mechanism for returning results  
4750 and error codes for each type of artifact.

### 4751 13.1.8 Cleanup

4752 After the artifact has been processed by the artifact processor, the orchestrator could perform optional  
4753 cleanup:

- 4754
- If an artifact processor was deployed within the topology that is being orchestrated, the orchestrator could decide to remove the artifact processor (and all its deployed dependencies) from the topology with the goal of not leaving behind any components that are not explicitly modeled in the service template.
- 4755
- 4756
- 4757
- Alternatively, the orchestrator MAY be able to reflect the additional components/resources associated with the Artifact Processor as part of the instance model (post deployment).
- 4758
- 4759

4760 Artifact Processors that do not use the service template topology as their execution environment do not  
4761 impact the deployed topology. It is up to each orchestrator implementation to decide if these artifact  
4762 processors need to be removed.

## 4763 13.2 Dynamic Artifacts

4764 Detailed Artifacts may be generated on-the-fly as orchestration happens. May be  
4765 propagated to other nodes in the topology. How do we describe those?

## 4766 13.3 Discussion of Examples

4767 This section shows how orchestrators might execute the steps listed above for a few common artifact  
4768 types, in particular:

- 4769 1. Shell scripts
- 4770 2. Python scripts
- 4771 3. Package artifacts
- 4772 4. VM images
- 4773 5. Container images
- 4774 6. API artifacts
- 4775 7. Non-standard artifacts

4776 By illustrating how different types of artifacts are intended to be processed, we identify the information  
4777 needed by artifact processors to properly process the artifacts, and we will also identify the components  
4778 in the topology from which this information is intended to be obtained.

### 4779 13.3.1 Shell Scripts

4780 Many artifacts are simple bash scripts that provide implementations for operations in a Node's Lifecycle  
4781 Interfaces. Bash scripts are typically intended to be executed on Compute nodes that host the node with  
4782 which these scripts are associated.

4783

4784 We use the following example to illustrate the steps taken by TOSCA orchestrators to process shell script  
4785 artifacts.

4786

4787

```
tosca_definitions_version: tosca_simple_yaml_1_0
description: Sample tosca archive to illustrate simple shell script usage.
template_name: tosca-samples-shell
template_version: 1.0.0-SNAPSHOT
template_author: TOSCA TC

node_types:
  tosca.nodes.samples.LogIp:
    derived_from: tosca.nodes.SoftwareComponent
    description: Simple linux cross platform create script.
    attributes:
      log_attr: { get_operation_output: [SELF, Standard, create, LOG_OUT] }
    interfaces:
```



```

Standard:
  create:
    inputs:
      SELF_IP: { get_attribute: [HOST, ip_address] }
    implementation: scripts/create.sh

topology_template:
  node_templates:
    log_ip:
      type: tosca.nodes.samples.LogIp
      requirements:
        - host:
            node: compute
            capability: tosca.capabilities.Container
            relationship: tosca.relationships.HostedOn
# Any linux compute.
compute:
  type: tosca.nodes.Compute
  capabilities:
    os:
      properties:
        type: linux

```

4788

4789 This example uses the following script to install the LogIP software :

4790

```

#!/bin/bash

# This is exported so available to fetch as output using the get_operation_output
function
export LOG_OUT="Create script : $SELF_IP"

# Just a simple example of create operation, of course software installation is
better
echo "$LOG_OUT" >> /tmp/tosca_create.log

```

4791

4792

4793 For this simple example, the artifact processing steps outlined above are as follows:

4794

4795 1. **Identify Artifact Processor:** The artifact processor for bash shell scripts is the “bash” program.

4796 2. **Establish Execution Environment:** The typical execution environment for bash scripts is the

4797 Compute node representing the Host of the node containing the artifact.

- 4798 3. **Configure User Account:** The bash user account is the default user account created when  
4799 instantiating the Compute node. It is assumed that this account has been configured with sudo  
4800 privileges.
- 4801 4. **Deploy Artifact Processor:** TOSCA orchestrators can assume that bash is pre-installed on all  
4802 Compute nodes they orchestrate, and nothing further needs to be done.
- 4803 5. **Deploy Dependencies:** Orchestrators should copy all provided artifacts using a directory  
4804 structure that mimics the directory structure in the original CSAR file containing the artifacts.  
4805 Since no dependencies are specified in the example above, nothing further needs to be done.
- 4806 6. **Identify Target:** The target for bash is the Compute node itself.
- 4807 7. **Pass Inputs and Retrieve Outputs:** Inputs are passed to bash as environment variables. In the  
4808 example above, there is a single input declared for the create operation called SELF\_IP. Before  
4809 processing the script, the Orchestrator creates a corresponding environment variable in the  
4810 execution environment. Similarly, the script creates a single output that is passed back to the  
4811 orchestrator as an environment variable. This environment variable can be accessed elsewhere  
4812 in the service template using the get\_operation\_output function.

### 4813 13.3.1.1 Progression of Examples

4814 The following examples show a number of potential use case variations (not exhaustive) :

4815

#### 4816 13.3.1.1.1 Simple install script that can run on all flavors for Unix.

4817 For example, a Bash script called “create.sh” that is used to install some software for a TOSCA Node;  
4818 that this introduces imperative logic points (all scripts perhaps) which MAY lead to the creation of “opaque  
4819 software” or topologies within the node

4820

4821

#### 4822 13.3.1.1.1.1 Notes

- 4823 • Initial examples used would be independent of the specific flavor of Linux.
- 4824 • The “create” operation, as part of the normative Standard node lifecycle, has special meaning in  
4825 TOSCA in relation to a corresponding deployment artifact; that is, the node is not longer  
4826 “abstract” if it either has an impl. Artifact on the create operation or a deployment artifact  
4827 (provided on the node).

4828 “create.sh” prepares/configures environment/host/container for other software (see below for VM image  
4829 use case variants).

#### 4830 13.3.1.1.1.2 Variants

- 4831 1. “create.sh” followed by a “configure.sh” (or “stop.sh”, “start.sh” or a similar variant).
- 4832 2. in Compute node (i.e., within a widely-used, normative, abstract Node Type).
- 4833 3. In non-compute node like WebServer (is this the hello world)?
  - 4834 • Container vs. Containee “hello worlds”; create is “special”; speaks to where (target) the  
4835 script is run at! i.e., Compute node does not have a host.
  - 4836 • What is BEST PRACTICE for compute? Should “create.sh” even be allowed?
  - 4837 • Luc: customer wanted to use an non-AWS cloud, used shell scripts to cloud API.
    - 4838 i. Should have specific Node type subclass for Compute for that other Cloud (OR)  
4839 a capability that represents that specific target Cloud.

4840 **13.3.1.1.2 Script that needs to be run as specific user**

4841 For example, a Postgres user

4842 **13.3.1.1.3 Simple script with dependencies**

4843 For example, using example from the meeting where script depends on AWS CLI being installed.

4844

- 4845
- How do you decide whether to install an RPM or python package for the AWS dependency?
  - How do we decide whether to install python packages in virtualenv vs. system-wide?
- 4846

4847 **13.3.1.1.4 Different scripts for different Linux flavors**

4848 For example. run apt-get vs. yum

- 4849
- The same operation can be implemented by different artifacts depending on the flavor of Linux on which the script needs to be run. We need the ability to specify which artifacts to use based on the target.
  - How do we extend the “operation” grammar to allow for the selection of one specific artifact out of a number of options?
  - How do we annotate the artifacts to indicate that they require a specific flavor and/or version of Linux?
- 4850
- 4851
- 4852
- 4853
- 4854
- 4855

4856 **13.3.1.1.4.1 Variants**

- 4857
- A variant would be to use different subclasses of abstract nodes, one for each flavor of Linux on which the node is supposed to be deployed. This would eliminate the need for different artifacts in the same node. Of course, this significantly reduces the amount of “abstraction” in service templates.
- 4858
- 4859
- 4860

4861 **13.3.1.1.5 Scripts with environment variables**

- 4862
- Environment variables that may not correspond to input parameters
  - For example, OpenStack-specific environment variables
  - How do we specify that these environment variables need to be set?
- 4863
- 4864

4865 **13.3.1.1.6 Scripts that require certain configuration files**

4866 For example, containing AWS credentials

- 4867
- This configuration file may need to be created dynamically (rather than statically inside a CSAR file). How do we specify that these files may need to be created?
  - Or does this require template files (e.g. Jinja2)?
- 4868
- 4869

4870 **13.3.2 Python Scripts**

4871 A second important class of artifacts are Python scripts. Unlike Bash script artifacts, Python scripts are more commonly executed within the context of the Orchestrator, but service template designers must also be able to provide Python scripts artifacts that are intended to be executed within the topology being orchestrated,

4872

4873

4874

4875 **13.3.2.1 Python Scripts Executed in Orchestrator**

4876 Need a simple example of a Python script executed in the Orchestrator context.

4877 **13.3.2.2 Python Scripts Executed in Topology**

4878           Need a simple example of a Python script executed in the topology being orchestrated.

4879

4880 The following grammar is provided to allow service providers to specify the execution environment within  
4881 which the artifact is intended to be processed :

4882           Need to decide on grammar. Likely an additional keyword to the “operation” section of  
4883 lifecycle interface definitions.

4884 **13.3.2.3 Specifying Python Version**

4885 Some python scripts conform to Python version 2, whereas others may require version 3. Artifact  
4886 designers use the following grammar to specify the required version of Python:

4887

4888 TODO

4889 **13.3.2.3.1.1 Assumptions/Questions**

- 4890           • Need to decide on grammar. Is artifact processor version associated with the processor, with the  
4891 artifact, the artifact type, or the operation implementation?

4892 **13.3.2.4 Deploying Dependencies**

4893 Most Python scripts rely on external packages that must be installed in the execution environment.  
4894 Typically, python packages are installed using the ‘pip’ command. To provide isolation between different  
4895 environments, is is considered best practice to create virtual environments. A virtual environment is a tool  
4896 to keep the dependencies required by different python scripts or projects in separate places, by creating  
4897 virtual Python environments for each of them.

4898

4899 The following example shows a Python script that has dependencies on a number of external packages:

4900 TODO

4901

4902 **13.3.2.4.1.1 Assumptions/Questions**

- 4903           • Python scripts often have dependencies on a number of external packages (that are referenced  
4904 by some package artifcat). How would these be handled?
- 4905           • How do we account for the fact that most python packages are available as Linux packages as  
4906 well as pip packages?
- 4907           • Does the template designer need to specify the use of virtual environments, or is this up to the  
4908 orchestrator implementation? Must names be provided for virtual environments?

4909 **13.3.2.4.1.2 Notes**

- 4910           • Typically, dependent artifacts must be processed in a specific order. TOSCA grammar must  
4911 provide a way to define orders and groups (perhaps by extending groups grammar by allowing  
4912 indented sub-lists).

4913 **13.3.3 Package Artifacts**

4914 Most software components are distributed as software packages that include an archive of files and  
4915 information about the software, such as its name, the specific version and a description. These packages  
4916 are processed by a package management system (PMS), such as rpm or YUM, that automates the  
4917 software installation process.

4918

4919 Linux packages are maintained in Software Repositories, databases of available application installation  
4920 packages and upgrade packages for a number of Linux distributions. Linux installations come pre-  
4921 configured with a default Repository from which additional software components can be installed.

4922

4923 While it is possible to install software packages using Bash script artifacts that invoke the appropriate  
4924 package installation commands (e.g. using apt or yum), TOSCA provides improved portability by allowing  
4925 template designers to specify software package artifacts and leaving it up to the orchestrator to invoke the  
4926 appropriate package management system.

### 4927 **13.3.3.1 RPM Packages**

4928 The following example shows a software component with an RPM package artifact.

4929         Need a simple example

### 4930 **13.3.4 Debian Packages**

4931 The following example shows a software component with Debian package artifact.

4932

4933         Need a simple example

#### 4934 **13.3.4.1.1.1 Notes**

- 4935         • In this scenario, the host on which the software component is deployed must support RPM  
4936             packages. This must be reflected in the software component's host requirement for a target  
4937             container.
- 4938         • In this scenario, the host on which the software component is deployed must support Debian  
4939             packages. This must be reflected in the software component's host requirement for a target  
4940             container.

### 4941 **13.3.4.2 Distro-Independent Service Templates**

4942 Some template designers may want to specify a generic application software topology that can be  
4943 deployed on a variety of Linux distributions. Such templates may include software components that  
4944 include multiple package artifacts, one for each of the supported types of container platforms. It is up to  
4945 the orchestrator to pick the appropriate package depending on the type of container chosed at  
4946 deployment time.

4947

4948 Supporting this use case requires the following:

- 4949         • Allow multiple artifacts to be expressed for a given lifecycle operation.
- 4950         • Associate the required target platform for which each of those artifacts was meant.

#### 4951 **13.3.4.2.1.1 Assumptions/Questions**

4952         How do we specify multiple artifacts for the same operation?

4953         How we we specify which platforms are support for each artifact? In the artifact itself? In  
4954         the artifact type?

## 4955 13.3.5 VM Images

### 4956 13.3.5.1.1 Premises

- 4957 • VM Images is a popular opaque deployment artifact that may deploy an entire topology that is not  
4958 declared itself within the service template.

### 4959 13.3.5.1.1.2 Notes

- 4960 • The “create” operation, as part of the normative Standard node lifecycle, has special meaning in  
4961 TOSCA in relation to a corresponding deployment artifact; that is, the node is not longer  
4962 “abstract” if it either has an impl. Artifact on the create operation or a deployment artifact  
4963 (provided on the node).

### 4964 13.3.5.1.1.3 Assumptions/Questions

- 4965 • In the future, the image itself could contain TOSCA topological information either in its metadata or  
4966 externally as an associated file.
  - 4967 ○ Can these embedded or external descriptions be brought into the TOSCA Service Template  
4968 or be reflected in an instance model for management purposes?
- 4969 • Consider create.sh in conjunction with a VM image deployment artifact
  - 4970 ○ VM image only (see below)
  - 4971 ○ Create.sh and VM image, both. (Need to address argument that they belong in different  
4972 nodes).
  - 4973 ○ Configure.sh with a VM image.? (see below)
  - 4974 ○ Create.sh only (no VM image)
- 4975 • Implementation Artifact (on TOSCA Operations):
  - 4976 ○ Operations that have an artifact (implementation).
- 4977 • Deployment Artifacts:
  - 4978 ○ Today: it must appear in the node under “artifacts” key (grammar)
  - 4979 ○ In the Future, should it:
    - 4980 ▪ Appear directly in “create” operation, distinguish by “type” (which indicates  
4981 processor)?
    - 4982 ▪ <or> by artifact name (by reference) to artifact declared in service template.
    - 4983 ▪ What happens if on create and in node (same artifact=ok? Different=what  
4984 happens? Error?)
    - 4985 ▪ What is best practice? And why? Which way is clearer (to user?)?
    - 4986 ▪ Processing order (use case variant) if config file and VM image appear on same  
4987 node?

## 4988 13.3.6 Container Images

### 4989 13.3.7 API Artifacts

4990 Some implementations may need to be implemented by invoking an API on a remote endpoint. While  
4991 such implementations could be provided by shell or python scripts that invoke API client software or use  
4992 language-specific bindings for the API, it might be preferred to use generic API artifacts that leave  
4993 decisions about the tools and/or language bindings to invoke the API to the orchestrator.

4994 To support generic API artifacts, the following is required:

- 4995 • A format in which to express the target endpoint and the required parameters for the API call
- 4996 • A mechanism for binding input parameters in the operation to the appropriate parameters in the  
4997 API call.

4998       • A mechanism for specifying the results and/or errors that will be returned by the API call

4999 Moreover, some operations may need to be implemented by making more than one API call. Flexible API  
5000 support requires a mechanism for expressing the control logic that runs those API calls.

5001 It should be possible to use a generic interface to describe these various API attributes without being  
5002 forced into using specific software packages or API tooling. Of course, in order to “invoke” the API an  
5003 orchestrator must launch an API client (e.g. a python script, a Java program, etc.) that uses the  
5004 appropriate API language bindings. However, using generic API Artifact types, the decision about which  
5005 API clients and language bindings to use can be left to the orchestrator. It is up to the API Artifact  
5006 Processor provided by the Orchestrator to create an execution environment within which to deploy API  
5007 language bindings and associated API clients based on Orchestrator preferences. The API Artifact  
5008 Processor then uses these API clients to “process” the API artifact.

5009       **13.3.7.1 Examples**

- 5010       • REST
- 5011       • SOAP
- 5012       • OpenAPI
- 5013       • IoT
- 5014       • Serverless

5015       **13.3.8 Non-Standard Artifacts with Execution Wrappers**

5016       TODO

5017       **13.4 Artifact Types and Metadata**

5018       To unambiguously describe how artifacts need to be processed, TOSCA provides two things:

- 5019       1. Artifact types that define standard ways to process artifacts.
- 5020       2. Descriptive metadata that provide information needed to properly process the artifact.

5021

## 14 Abstract nodes and target node filters matching

5022

This section details the matching or orchestrator's node selection mechanisms that is mentioned and explained from user point of view in section 2.9 of the specification.

5023

5024

5025

When a user define a service template some of the nodes within the service templates are not implemented (abstract) and some requirements may define some node filters target rather than actual abstract node templates. In order to deploy such service templates the orchestrator has to find a valid fulfillment and implementation available on the deployment target in order to be able to actually instantiate the various elements of the template.

5026

5027

5028

5029

5030

5031

The goal of this **non-normative** chapter is to give an non-exclusive insight on orchestrator possible behavior to provide fulfillment to abstract nodes and dangling requirements within a TOSCA template.

5032

### 14.1 Reminder on types

5033

5034

TOSCA allows the definition of types that can later be used within templates. Types can be of two nature on regard of the matching process:

5035

5036

5037

- **Abstract types** that have no implementation specified and that can be used within a Topology template in order to request the orchestrator to find a valid implementation (for example an abstract `tosca.nodes.Compute` type can be used to define a template to request a VM from an orchestrator without any specific knowledge on the implementation, allowing that way portability).

5038

5039

5040

5041

- **Concrete types** that are implemented through TOSCA implementation artifacts (shell scripts, python scripts etc.) or through the mean of a Topology substitution.

5042

5043

5044

Both abstract and concrete types defines properties (and capabilities properties) that can be used for two different means:

5045

5046

- **Configuration** of the node and of it's behavior (most likely used in concrete types).

5047

- **Matching** purpose (most likely used for abstract types).

5048

5049

This section will focus on the matching process while configuration properties is mostly related to types design.

5050

### 14.2 Orchestrator catalogs

5051

5052

Most of orchestrators are likely to have internal catalogs of TOSCA types, pre-defined templates, internal implementation of nodes (either through concrete types, substitution mechanisms, potentially supported by non-normative workflow definitions etc.) and maybe even running instances (services).

5053

5054

5055

5056

Theses catalogs are not normative and it is up to the TOSCA implementation to support some or all of them. During matching the TOSCA orchestrator may find a valid match for a template within any of it's internal catalogs or through any other mean.

5057

5058

5059

5060

This section will consider and provide examples based on the three following catalogs (they may or may not be used in actual implementations):

5061

5062

- **Type catalog:** Basic internal catalog but not the most intuitive candidate for node matching. It contains:

5063

5064

- abstract node types



- 5065 ○ concrete node types implemented through implementation artifacts.
- 5066 ○ concrete node types implemented through topology substitution.
- 5067 • **Pre-defined node template catalog:** This is the catalog that is the most likely to be used for
- 5068 matching, it may contains:
- 5069 ○ Orchestrator Provider pre-defined node templates offered to it's user eventually backed
- 5070 up with orchestrator specific implementations (that may delegate to non-tosca internal
- 5071 components).
- 5072 ○ User defined node templates implemented through implementation artifacts.
- 5073 ○ User defined node templates implemented through topology substitution.
- 5074 • **Running instance/Services catalog:** Catalog of already running services available for matching
- 5075 that contains some definition of TOSCA instances.

### 5076 14.3 Abstract node template matching

5077 A TOSCA topology template as defined by a user will probably define some abstract node templates. A  
 5078 node template is considered abstract if it is based on an abstract type and does not provides  
 5079 implementation at the template level. As instanciating an abstract node can not be done by an  
 5080 orchestrator, the orchestrator will have to perform internally the replacement of the defined abstract node  
 5081 template's types by a matching implementation of the type.

5082  
 5083 **A type** is considered as a valid matching implementation if it fullfills all of the following conditions:

- 5084 • The matching node derives from the type specified in the template
- 5085 • Every property defined in the matching node is matching the constraint specified on the node
- 5086 template's properties or capability properties given the following rules:
- 5087 ○ A property that is defined in the node template (either through a value at the template
- 5088 level or through a default property value at the type level) should be match the constraint
- 5089 defined on the matching node type property.
- 5090 ○ A property that is not defined in the node template may have no or any value (matching
- 5091 the node type property definition constraints) in the orchestrator matched node.

5092  
 5093 **A pre-defined template** is considered as a valid matching implementation if it fullfills all of the following  
 5094 conditions:

- 5095 • The orchestrator pre-defined matching node derives from the type specified in the topology
- 5096 template's node
- 5097 • Every property defined in the orchestrator pre-defined matching node is matching the constraint
- 5098 specified on the node template's properties or capability properties given the following rules:
- 5099 ○ A property that is defined in the node template (either through a value at the template
- 5100 level or through a default property value at the type level) should be matched by an
- 5101 equality constraint
- 5102 ○ A property that is not defined in the node template may have no or any value (matching
- 5103 the node type property definition constraints) in the orchestrator matched node.

5104  
 5105 **A running instance (service)** is considered as a valid matching implementation if it fullfills all of the  
 5106 following conditions:

- 5107 • The node instance has a type that equals or derives from the type specified in the topology
- 5108 template's node
- 5109 • Every attribute defined in the orchestrator instance node is matching the constraint specified on
- 5110 the node template's properties or capability properties given the following rules:

- 5111           ○ A property that is defined in the node template (either through a value at the template  
5112           level or through a default property value at the type level) should be matched by an  
5113           equality constraint against the attribute value.  
5114           ○ A property that is not defined in the node template may have no or any value (matching  
5115           the node type property definition constraints) in instance node.

5116           Note that the node instance that defines the running instance/service can be actually a full topology that  
5117           propose a node abstraction through the topology substitution mechanism.

5118

5119           **Multiple valid matches:** If the orchestrator has more than one valid match in it's catalog(s) he is  
5120           responsible for either choosing automatically a node or providing a mean for users to specify the node  
5121           they want to select.

5122

5123           **No match:** If the orchestrator does not find any valid match he could propose alternative that he consider  
5124           valid but should not automatically deploy the topology without an explicit user approval.

5125

5126           Note: Theses rules are the basic matching rules of TOSCA, however if an orchestrator has a UI and want  
5127           to propose other matching nodes that does not fullfill all of these constraints he can still do that even if he  
5128           should warn the user that the deployed template will not be the same template as defined. For example  
5129           an orchestrator could propose a node with greater than CPU rather than an equal match, or propose an  
5130           equivalent node (with different type) that has the same capabilities as the ones connected by the node in  
5131           the topology.

5132

5133           Note: Support of instances matching may impact the TOSCA workflow and lifecycle as their operations  
5134           will not be included in the workflow (instances are already created).

5135

## 5136           14.3.1 Examples

5137           Let's consider a few examples of abstract node templates and how they can be matched against an  
5138           orchestrator catalog(s). Note that the type catalog is not the only catalog in which to find implementation.  
5139           Most orchestrator will probably have an internal provider templates catalog that includes pre-defined  
5140           templates. None of the catalog is required to be a valid TOSCA implementation and the following are just  
5141           examples for orchestrator implementers but is not required to be implemented.

### 5142           14.3.1.1 Matching from a type catalog

5143           Let's consider the following node types in an orchestrator internal type catalog.

5144

```
tosca_definitions_version: tosca_simple_yaml_1_0

node_types:
  tosca.samples.nodes.MyAbstractNode:
    derived_from: tosca.nodes.Root
    properties:
      str_prop:
        type: string
      nbr_prop:
        type: integer
```

5145 MyAbstractNode is an abstract type as Root does not define any implementation and the defined node  
5146 neither.  
5147

```
node_types:
  toska.samples.nodes.MyNodeImpl1:
    derived_from: toska.samples.nodes.MyAbstractNode
    properties:
      nbr_prop :
        constraints:
          - greater_or_equal: 1
    interfaces:
      standard:
        create: test.sh
```

5148 MyNodeImpl1 is an implementation (through the test.sh script) of MyAbstractNode that requires the  
5149 nbr\_prop property to be higher than 1.  
5150

```
tosca_definitions_version: toska_simple_yaml_1_0

node_types:
  toska.samples.nodes.MyNodeImpl2:
    derived_from: toska.samples.nodes.MyAbstractNode
    properties:
      nbr_prop :
        constraints:
          - greater_or_equal: 25
    interfaces:
      standard:
        create: test2.sh
```

5151 MyNodeImpl2 is an implementation (through the test2.sh script) of MyAbstractNode that requires the  
5152 nbr\_prop property to be higher than 25.  
5153

5154 Let's consider the following topology template that a user want to deploy:  
5155

```
tosca_definitions_version: toska_simple_yaml_1_0

topology_template:
  node_templates:
    my_node:
      type: toska.samples.MyAbstractNode
      properties:
```

```
str_prop: standard
nbr_prop: 10
```

5156 The specified node template (my\_node) is an abstract node template as it's type is abstract and it does  
5157 not add any implementation. Before being able to deploy this template a TOSCA orchestrator will have to  
5158 find a valid match for this node. In order to do so it will look into it's catalog (in this example the type  
5159 catalog) and try to find nodes that matches the definition.

5160 In this example while both MyNodeImpl1 and MyNodeImpl2 have a valid type as they derive from  
5161 MyAbstractNode only MyNodeImpl1 is a valid match as the constraint defined on the nbr\_prop property of  
5162 the MyNodeImpl2 node type (greater\_or\_equal: 25) is not matching the property value defined in the  
5163 requested node template (10).

5164

### 5165 14.3.1.2 Matching from a pre-defined template catalog

5166 This example details how a `tosca.nodes.Compute` abstract node can be matched to a specific pre-defined  
5167 template that an orchestrator may have. First of all the orchestrator will probably define a concrete  
5168 implementation of the Compute node. So let's consider the following example type

5169

```
tosca_definitions_version: tosca_simple_yaml_1_0

node_types:
  tosca.samples.nodes.MyCloudCompute:
    derived_from: tosca.nodes.Compute
    properties:
      image_id:
        type: string
        required: true
      flavor_id:
        type: string
        required: true
    interfaces:
      standard:
        create: create.py
```

5170 This type add two properties to the Compute node so the orchestrator knows which `image_id` and  
5171 `flavor_id` are used to instantiate the VM. Implementation is simplified here and just a single python script  
5172 is enough.

5173

5174 Note: an orchestrator provider can define internally some non-portable implementations of types that will  
5175 be supported only by the latter. As the user defines an abstract node it's template is portable even if the  
5176 execution is specific to the orchestrator.

5177

5178 Let's now consider that the orchestrator has defined some internal node template in it's own pre-defined  
5179 templates or provider catalog (note that this is orchestrator specific and this specification has no intent on  
5180 defining how the orchestrator should manage, import or support it's internal catalogs).

5181

```
tosca_definitions_version: tosca_simple_yaml_1_0
```

```
node_templates:
```

```
  small_ubuntu:
```

```
    type: tosca.samples.nodes.MyCloudCompute
```

```
    properties:
```

```
      image_id: ubuntu
```

```
      flavor_id: small
```

```
    capabilities:
```

```
      host:
```

```
        num_cpus: 1
```

```
        cpu_frequency: 1 GHz
```

```
        disk_size: 15 GiB
```

```
        mem_size: 2 GiB
```

```
      os:
```

```
        type: linux
```

```
        distribution: ubuntu
```

```
  large_ubuntu:
```

```
    type: tosca.samples.nodes.MyCloudCompute
```

```
    properties:
```

```
      image_id: ubuntu
```

```
      flavor_id: small
```

```
    capabilities:
```

```
      host:
```

```
        num_cpus: 4
```

```
        cpu_frequency: 2 GHz
```

```
        disk_size: 15 GiB
```

```
        mem_size: 8 GiB
```

```
      os:
```

```
        type: linux
```

```
        distribution: ubuntu
```

```
  large_windows:
```

```
    type: tosca.samples.nodes.MyCloudCompute
```

```
    properties:
```

```
      image_id: ubuntu
```

```
      flavor_id: small
```

```
    capabilities:
```

```
      host:
```

```
        num_cpus: 4
```

```
        cpu_frequency: 2 GHz
```

```
        disk_size: 15 GiB
```

```
    mem_size: 8 GiB
  os:
    type: windows
    distribution: server
```

5182

5183 If a user defines the following template:

5184

```
tosca_definitions_version: tosca_simple_yaml_1_1_0

topology_template:
  node_templates:
    my_node:
      type: tosca.nodes.Compute
      capabilities:
        host:
          num_cpus: 1
          mem_size: 2 GiB
      os:
        distribution: Ubuntu
```

5185 The orchestrator will select the `small_ubuntu` pre-defined template as a valid match. The `image_id` and  
5186 `flavor_id` properties are internal to the orchestrator.

## 5187 14.4 Target node filter matching

5188 In addition to matching abstract nodes, an orchestrator also has to find matches for dangling  
5189 requirements. Target node filter (also referred as dangling requirements) matching provides loose  
5190 coupling as you may specify a request on any node that provides a capability rather than a specific node.

5191

5192 A dangling requirement is defined on the requirement section of a node template, it instruct the  
5193 orchestrator how to find a valid node template to add and connect in the topology. The node added by the  
5194 orchestrator as a relationship target is matched based on the following rules.

5195

5196 **A type** is considered as a valid matching implementation if it fullfills all of the following conditions:

- 5197 • The selected node must define a capability with the same type as specified by the dangling  
5198 requirement or with a type that derive from the specified type.
- 5199 • If the `node` property is specified on the dangling requirement, then the type of the matched node  
5200 must derive from the requested type
- 5201 • The node filter constraints defined on the dangling requirement are compatible with the candidate  
5202 node type properties constraints and default values.

5203

5204 **A pre-defined template** is considered as a valid matching implementation if it fullfills all of the following  
5205 conditions:

- 5206 • The orchestrator pre-defined node defines a capability with the same type as specified by the  
5207 dangling requirement or with a type that derive from the specified type.

- 5208
- 5209
- 5210
- 5211
- If the *node* property is specified on the dangling requirement, then the type of the orchestrator pre-defined node must derive from the requested type
  - The node filter constraints defined on the dangling requirement are matched by the pre-defined template properties values.

5212

5213 **A running instance (service)** is considered as a valid matching implementation if it fullfills all of the  
5214 following conditions:

- 5215
- 5216
- 5217
- 5218
- 5219
- 5220
- The orchestrator pre-defined node defines a capability with the same type as specified by the dangling requirement or with a type that derive from the specified type.
  - If the *node* property is specified on the dangling requirement, then the type of the node instance must derive from the requested type
  - The node filter constraints defined on the dangling requirement are matched by the node instance current attribute values

5221

5222 A property that is not defined in the node template may have no or any value (matching the node type  
5223 property definition constraints) in instance node.

## 5224 14.4.1 Examples

### 5225 14.4.1.1 Matching a node filter target against a type catalog

5226 Let's consider the following nodes in a type catalog:

5227

```
tosca_definitions_version: tosca_simple_yaml_1_0

capability_types:
  tosca.samples.capabilities.MyMessagingEndpoint :
    derived_from: tosca.capabilities.Endpoint
    properties:
      throughput :
        type: integer
        required: true
  tosca.samples.capabilities.MyLimitedMessagingEndpoint :
    derived_from: tosca.samples.capabilities.MyMessagingEndpoint
    properties:
      throughput :
        type: integer
        required: true
      constraints:
        - lower_than: 5

node_types:
  tosca.samples.nodes.MyNode :
```

```

derived_from: tosca.nodes.Root
requirements: tosca.samples.capabilities.MyMessagingEndpoint
interfaces:
  standard:
    create: install.sh
tosca.samples.nodes.MyAbstractMessagingSystem:
  derived_from: tosca.nodes.Root
  properties:
    scaling:
      type: string
      required: true
      constraints:
        - valid_values: [ "auto", "manual", "none" ]
    highly_available :
      type: boolean
      required: true
  capabilities:
    messaging: tosca.samples.capabilities.MyMessagingEndpoint
tosca.samples.nodes.MyMessagingServiceSystem:
  derived_from: tosca.samples.nodes.MyAbstractMessagingSystem
  properties:
    scaling :
      type: string
      required: true
      constraints:
        - valid_values: [ "manual" ]
    highly_available:
      constraints:
        - equal: true
  interfaces:
    standard:
      create: create.py
tosca.samples.nodes.MyMessagingSystem:
  derived_from: tosca.samples.nodes.MyAbstractMessagingSystem
  properties:
    scaling :
      type: string
      required: true
      constraints:
        - valid_values: [ "none" ]
    highly_available:

```



```

constraints:
  - equal: false
capabilities:
  messaging: tosca.samples.capabilities.MyLimitedMessagingEndpoint
interfaces:
  standard:
    create: install.sh
    start: start.sh

```

5228

5229 And the following user template to deploy:

5230

```

tosca_definitions_version: tosca_simple_yaml_1_0

topology_template:
  node_templates:
    my_node:
      type: tosca.samples.nodes.MyNode
      requirements:
        - messaging:
            node: tosca.samples.nodes.MyAbstractMessagingSystem
            node_filter:
              properties:
                - scaling: { valid_values: [manual, auto] }
                - highly_available: { equal: true }
            capabilities:
              - tosca.samples.capabilities.MyMessagingEndpoint:
                  properties:
                    - throughput: { greater_than: 10 }

```

5231 In order to fulfill the messaging endpoint target the orchestrator will have to add a node template from a  
 5232 type that derives from MyAbstractMessagingSystem (as specified within the node filter node property)  
 5233 and that defines constraints that are compatible with the ones specified on the node filter.

5234 In the defined type catalog the only type that fulfill all constraints is the MyMessagingServiceSystem  
 5235 node.

5236

#### 5237 **14.4.1.2 Matching a node filter target against a type catalog with substitution**

5238 TOSCA allows the definition of a type implementation through a substitution template. In this case the  
 5239 specified topology templates becomes a type in the catalog. From this type an orchestrator may define  
 5240 some pre-defined templates or even running services if instantiated. In the following example we will  
 5241 consider the same user template as in the previous example as well as the same abstract types. However  
 5242 the implemented type will be defined through the following topology template:

5243

5244

```
tosca_definitions_version: toska_simple_yaml_1_0

topology_template:
  inputs:
    # Nodes in this topology can be configured to enable auto-scaling or not
    scaling_input :
      type: string
      required: true
      constraints:
        - valid_values: [ "auto", "none" ]

  substitution_mappings:
    node_type: toska.samples.nodes.MyAbstractMessagingSystem
    properties:
      scaling: [ scaling_input ]
      highly_available: true
    capabilities:
      messaging : [ my_load_balancer, load_balanced_messaging_endpoint]
  node_templates:
    my_load_balancer:
      type: toska.samples.nodes.MyLoadBalancer
      capability:
        load_balanced_messaging_endpoint:
tosca.samples.capabilities.MyMessagingEndpoint
      my_other_node_that_trigger_a_service_somewhere:
        type: org.custom.Type
        properties:
          my_scaling_info: get_input { scaling }
    my_other_node:
      type: org.something.Type:
      properties:
        my_other_scaled_prop: get_input { scaling }
        another_prop: value
    ... other nodes templates
```

5245

5246 This template from a substitution boundaries point of view would be equivalent to the following node type:

5247

```
tosca_definitions_version: toska_simple_yaml_1_0
```

```

node_type:
  my_node_resulting_from_topology
  # From topology_template -> substitution_mappings -> node_type
  derived_from: tosca.samples.nodes.MyAbstractMessagingSystem
  properties:
    scaling :
      constraints:
        - valid_values: [ "auto", "none" ]
    highly_available:
      default: true
      constraints:
        - equal: true
  # Equivalent:
  # implementation: The topology specified above

```

5248

5249 In this example the orchestrator can select the topology template specified above as a valid match for the  
 5250 requested target node filter.

## 5251 **14.5 Post matching properties**

5252 It is possible that, even after matching, some properties have unset values, moreover some properties  
 5253 may be added by the type that is selected by the orchestrator and derives from the user requested type.  
 5254 In any case an orchestrator should not deploy a node that has some required properties undefined.

5255 Based on the orchestrator capabilities it could be possible to assign values to the properties (either  
 5256 required or not required) of the node after the matching, including properties added by the selected  
 5257 implementation node. Note that these capabilities are not mandatory and that as properties depends  
 5258 from the actual result of the matching it is not possible to ship them with the template. Therefore there is  
 5259 no standard for defining these additional properties and the mean of providing them will be specific to  
 5260 the orchestrator implementation.

5261

## 15 Conformance

5262

### 15.1 Conformance Targets

5263

The implementations subject to conformance are those introduced in Section 11.3 “Implementations”.

5264

They are listed here for convenience:

5265

- TOSCA YAML service template

5266

- TOSCA processor

5267

- TOSCA orchestrator (also called orchestration engine)

5268

- TOSCA generator

5269

- TOSCA archive

5270

### 15.2 Conformance Clause 1: TOSCA YAML service template

5271

A document conforms to this specification as TOSCA YAML service template if it satisfies all the

5272

statements below:

5273

- (a) It is valid according to the grammar, rules and requirements defined in section 3 “TOSCA Simple Profile definitions in YAML”.

5274

5275

- (b) When using functions defined in section 4 “TOSCA functions”, it is valid according to the grammar specified for these functions.

5276

5277

- (c) When using or referring to data types, artifact types, capability types, interface types, node types, relationship types, group types, policy types defined in section 5 “TOSCA normative type definitions”, it is valid according to the definitions given in section 5.

5278

5279

5280

### 15.3 Conformance Clause 2: TOSCA processor

5281

A processor or program conforms to this specification as TOSCA processor if it satisfies all the

5282

statements below:

5283

- (a) It can parse and recognize the elements of any conforming TOSCA YAML service template, and generates errors for those documents that fail to conform as TOSCA YAML service template while clearly intending to.

5284

5285

5286

- (b) It implements the requirements and semantics associated with the definitions and grammar in section 3 “TOSCA Simple Profile definitions in YAML”, including those listed in the “additional requirements” subsections.

5287

5288

5289

- (c) It resolves the imports, either explicit or implicit, as described in section 3 “TOSCA Simple Profile definitions in YAML”.

5290

5291

- (d) It generates errors as required in error cases described in sections 3.1 (TOSCA Namespace URI and alias), 3.2 (Parameter and property type) and 3.6 (Type-specific definitions).

5292

5293

- (e) It normalizes string values as described in section 5.4.9.3 (Additional Requirements)

5294

5295

### 15.4 Conformance Clause 3: TOSCA orchestrator

5296

A processor or program conforms to this specification as TOSCA orchestrator if it satisfies all the

5297

statements below:

5298

- (a) It is conforming as a TOSCA Processor as defined in conformance clause 2: TOSCA Processor.

5299

- (b) It can process all types of artifact described in section 5.3 “Artifact types” according to the rules and grammars in this section.

5300

5301

- (c) It can process TOSCA archives as intended in section 6 “TOSCA Cloud Service Archive (CSAR) format” and other related normative sections.

5302

- 5303 (d) It can understand and process the functions defined in section 4 “TOSCA functions” according to  
5304 their rules and semantics.  
5305 (e) It can understand and process the normative type definitions according to their semantics and  
5306 requirements as described in section 5 “TOSCA normative type definitions”.  
5307 (f) It can understand and process the networking types and semantics defined in section 7 “TOSCA  
5308 Networking”.  
5309 (g) It generates errors as required in error cases described in sections 2.10 (Using node template  
5310 substitution for chaining subsystems), 5.4 (Capabilities Types) and 5.7 (Interface Types.).

## 5311 **15.5 Conformance Clause 4: TOSCA generator**

5312 A processor or program conforms to this specification as TOSCA generator if it satisfies at least one of  
5313 the statements below:

- 5314 (a) When requested to generate a TOSCA service template, it always produces a conforming  
5315 TOSCA service template, as defined in Clause 1: TOSCA YAML service template,  
5316 (b) When requested to generate a TOSCA archive, it always produces a conforming TOSCA archive,  
5317 as defined in Clause 5: TOSCA archive.

## 5318 **15.6 Conformance Clause 5: TOSCA archive**

5319 A package artifact conforms to this specification as TOSCA archive if it satisfies all the statements below:

- 5320 (a) It is valid according to the structure and rules defined in section 6 “TOSCA Cloud Service Archive  
5321 (CSAR) format”.

5322

## Appendix A. Known Extensions to TOSCA v1.0

5323  
5324

The following items will need to be reflected in the TOSCA (XML) specification to allow for isomorphic mapping between the XML and YAML service templates.

5325

### A.1 Model Changes

5326  
5327  
5328  
5329  
5330  
5331  
5332  
5333  
5334  
5335  
5336  
5337  
5338  
5339  
5340  
5341  
5342  
5343  
5344  
5345  
5346  
5347

- The “TOSCA Simple ‘Hello World’” example introduces this concept in Section 2. Specifically, a VM image assumed to be accessible by the cloud provider.
- Introduce template Input and Output parameters
- The “Template with input and output parameter” example introduces concept in Section 2.1.1.
  - “Inputs” could be mapped to BoundaryDefinitions in TOSCA v1.0. Maybe needs some usability enhancement and better description.
  - “outputs” are a new feature.
- Grouping of Node Templates
  - This was part of original TOSCA proposal, but removed early on from v1.0 This allows grouping of node templates that have some type of logically managed together as a group (perhaps to apply a scaling or placement policy).
- Lifecycle Operation definition independent/separate from Node Types or Relationship types (allows reuse). For now, we added definitions for “node.lifecycle” and “relationship.lifecycle”.
- Override of Interfaces (operations) in the Node Template.
- Service Template Naming/Versioning
  - Should include TOSCA spec. (or profile) version number (as part of namespace)
- Allow the referencing artifacts using a URL (e.g., as a property value).
- Repository definitions in Service Template.
- Substitution mappings for Topology template.
- Addition of Group Type, Policy Type, Group def., Policy def. along with normative TOSCA base types for policies and groups.
- Addition of Artifact Processors (AP) as first class citizens

5348

### A.2 Normative Types

5349  
5350  
5351  
5352  
5353  
5354  
5355  
5356  
5357  
5358  
5359  
5360  
5361  
5362  
5363  
5364  
5365

- **Types / Property / Parameters**
  - list, map, range, scalar-unit types
  - Includes YAML intrinsic types
  - NetworkInfo, PortInfo, PortDef, PortSpec, Credential
  - TOSCA Version based on Maven
  - JSON and XML types (with schema constraints)
- **Constraints**
  - constraint clauses, regex
  - External schema support
- **Node**
  - Root, Compute, ObjectStorage, BlockStorage, Network, Port, SoftwareComponent, WebServer, WebApplicaton, DBMS, Database, Container, and others
- **Relationship**
  - Root, DependsOn, HostedOn, ConnectsTo, AttachesTo, RoutesTo, BindsTo, LinksTo and others
- **Artifact**
  - Deployment: Image Types (e.g., VM, Container), ZIP, TAR, etc.

- 5366
  - Implementation : File, Bash, Python, etc.
- 5367
- 5368
  - **Artifact Processors**
- 5369
  - New in v1.2 as “first class” citizen
- 5370
  - **Requirements**
- 5371
  - None
- 5372
  - **Capabilities**
- 5373
  - Container, Endpoint, Attachment, Scalable, ...
- 5374
  - **Lifecycle**
- 5375
  - Standard (for Node Types)
- 5376
  - Configure (for Relationship Types)
- 5377
  - **Functions**
- 5378
  - get\_input, get\_attribute, get\_property, get\_nodes\_of\_type, get\_operation\_output and
- 5379
  - others
- 5380
  - concat, token
- 5381
  - get\_artifact
- 5382
  - from (file)
- 5383
  - **Groups**
- 5384
  - Root
- 5385
  - **Policies**
- 5386
  - Root, Placement, Scaling, Update, Performance
- 5387
  - **Workflow**
- 5388
  - Complete declarative task-based workflow grammar.
- 5389
  - **Service Templates**
- 5390
  - Advanced “import” concepts
- 5391
  - Repository definitions
- 5392
  - **CSAR**
- 5393
  - Allow multiple top-level Service Templates in same CSAR (with equivalent functionality)
- 5394

5395

## Appendix B. Acknowledgments

5396 The following individuals have participated in the creation of this specification and are gratefully  
5397 acknowledged:

5398 **Contributors:**

- 5399 Alex Vul, ([alex.vul@intel.com](mailto:alex.vul@intel.com)), Intel  
5400 Avi Vachnis ([avi.vachnis@alcatel-lucent.com](mailto:avi.vachnis@alcatel-lucent.com)), Alcatel-Lucent  
5401 Chris Lauwers ([lauwers@ubicity.com](mailto:lauwers@ubicity.com))  
5402 Claude Noshpitz ([claudio.noshpitz@att.com](mailto:claudio.noshpitz@att.com)), AT&T  
5403 Derek Palma ([dpalma@vnomnic.com](mailto:dpalma@vnomnic.com)), Vnomnic  
5404 Frank Leymann ([Frank.Leymann@informatik.uni-stuttgart.de](mailto:Frank.Leymann@informatik.uni-stuttgart.de)), Univ. of Stuttgart  
5405 Gerd Breiter ([gbreiter@de.ibm.com](mailto:gbreiter@de.ibm.com)), IBM  
5406 Hemal Surti ([hsurti@cisco.com](mailto:hsurti@cisco.com)), Cisco  
5407 Ifat Afek ([ifat.afek@alcatel-lucent.com](mailto:ifat.afek@alcatel-lucent.com)), Alcatel-Lucent  
5408 Idan Moyal, ([idan@gigaspace.com](mailto:idan@gigaspace.com)), Gigaspaces  
5409 Jacques Durand ([jdurand@us.fujitsu.com](mailto:jdurand@us.fujitsu.com)), Fujitsu  
5410 Jin Qin, ([chin.qinjin@huawei.com](mailto:chin.qinjin@huawei.com)), Huawei  
5411 Jeremy Hess, ([jeremy@gigaspace.com](mailto:jeremy@gigaspace.com)), Gigaspaces  
5412 John Crandall, ([mailto:jcrandal@brocade.com](mailto:mailto:jcrandal@brocade.com)), Brocade  
5413 Juergen Meynert ([juergen.meynert@ts.fujitsu.com](mailto:juergen.meynert@ts.fujitsu.com)), Fujitsu  
5414 Kapil Thangavelu ([kapil.thangavelu@canonical.com](mailto:kapil.thangavelu@canonical.com)), Canonical  
5415 Karsten Beins ([karsten.beins@ts.fujitsu.com](mailto:karsten.beins@ts.fujitsu.com)), Fujitsu  
5416 Kevin Wilson ([kevin.l.wilson@hp.com](mailto:kevin.l.wilson@hp.com)), HP  
5417 Krishna Raman ([kraman@redhat.com](mailto:kraman@redhat.com)), Red Hat  
5418 Luc Boutier ([luc.boutier@fastconnect.fr](mailto:luc.boutier@fastconnect.fr)), FastConnect  
5419 Luca Gioppo, ([luca.gioppo@csi.it](mailto:luca.gioppo@csi.it)), CSI-Piemonte  
5420 Matt Rutkowski ([mrutkows@us.ibm.com](mailto:mrutkows@us.ibm.com)), IBM  
5421 Moshe Elisha ([moshe.elisha@alcatel-lucent.com](mailto:moshe.elisha@alcatel-lucent.com)), Alcatel-Lucent  
5422 Nate Finch ([nate.finch@canonical.com](mailto:nate.finch@canonical.com)), Canonical  
5423 Nikunj Nemani ([nnemani@vmware.com](mailto:nnemani@vmware.com)), Wmware  
5424 Priya TG ([priya.g@netcracker.com](mailto:priya.g@netcracker.com)) NetCracker  
5425 Richard Probst ([richard.probst@sap.com](mailto:richard.probst@sap.com)), SAP AG  
5426 Sahdev Zala ([spzala@us.ibm.com](mailto:spzala@us.ibm.com)), IBM  
5427 Shitao li ([lishitao@huawei.com](mailto:lishitao@huawei.com)), Huawei  
5428 Simeon Monov ([sdmonov@us.ibm.com](mailto:sdmonov@us.ibm.com)), IBM  
5429 Sivan Barzily, ([sivan@gigaspace.com](mailto:sivan@gigaspace.com)), Gigaspaces  
5430 Sridhar Ramaswamy ([sramasw@brocade.com](mailto:sramasw@brocade.com)), Brocade  
5431 Stephane Maes ([stephane.maes@hp.com](mailto:stephane.maes@hp.com)), HP  
5432 Steve Baillargeon ([steve.baillargeon@ericsson.com](mailto:steve.baillargeon@ericsson.com)), Ericsson  
5433 Tinh Nguyenphu ([thinh.nguyenphu@nokia.com](mailto:thinh.nguyenphu@nokia.com)), Nokia  
5434 Thomas Spatzier ([thomas.spatzier@de.ibm.com](mailto:thomas.spatzier@de.ibm.com)), IBM  
5435 Ton Ngo ([ton@us.ibm.com](mailto:ton@us.ibm.com)), IBM



5436 Travis Tripp ([travis.tripp@hp.com](mailto:travis.tripp@hp.com)), HP  
5437 Vahid Hashemian ([vahidhashemian@us.ibm.com](mailto:vahidhashemian@us.ibm.com)), IBM  
5438 Wayne Witzel ([wayne.witzel@canonical.com](mailto:wayne.witzel@canonical.com)), Canonical  
5439 Yaron Parasol ([yaronpa@gigaspace.com](mailto:yaronpa@gigaspace.com)), Gigaspaces

## Appendix C. Revision History

Revision	Date	Editor	Changes Made
WDO2, Rev01	2017-09-12	Luc Boutier	<ul style="list-style-type: none"> <li>Initial WDO2, Revision 01 baseline for TOSCA Simple Profile in YAML v1.2</li> </ul>
WDO2, Rev02	2017-10-03	Matt Rutkowski	<ul style="list-style-type: none"> <li>Developed Abstract.Compute and Abstract.Storage node types and inserted it into normative type hierarchy.</li> <li>Reversed the inheritance of toska.capabilities.Compute and toska.capabilities.Container to make Container the parent (abstract) Capability Type. Adjusted all Node types that had "host" capability or requirement defns. to reflect this change.</li> <li>Changed TOSCA namespace URI to reflect v1.2.</li> </ul>
WDO2, Rev03	2017-10-12	Luc Boutier	<ul style="list-style-type: none"> <li>Updated policy trigger condition to leverage the constraint clause definition introduced with workflows in 1.1</li> <li>Added simplified definition for constraint clause.</li> <li>Added Priya TG to the acknowledgements as she pushed this change/proposal.</li> </ul>